

MICHELIN AGRÍCOLA

DOCUMENTACIÓN TÉCNICA

DE NEUMÁTICOS

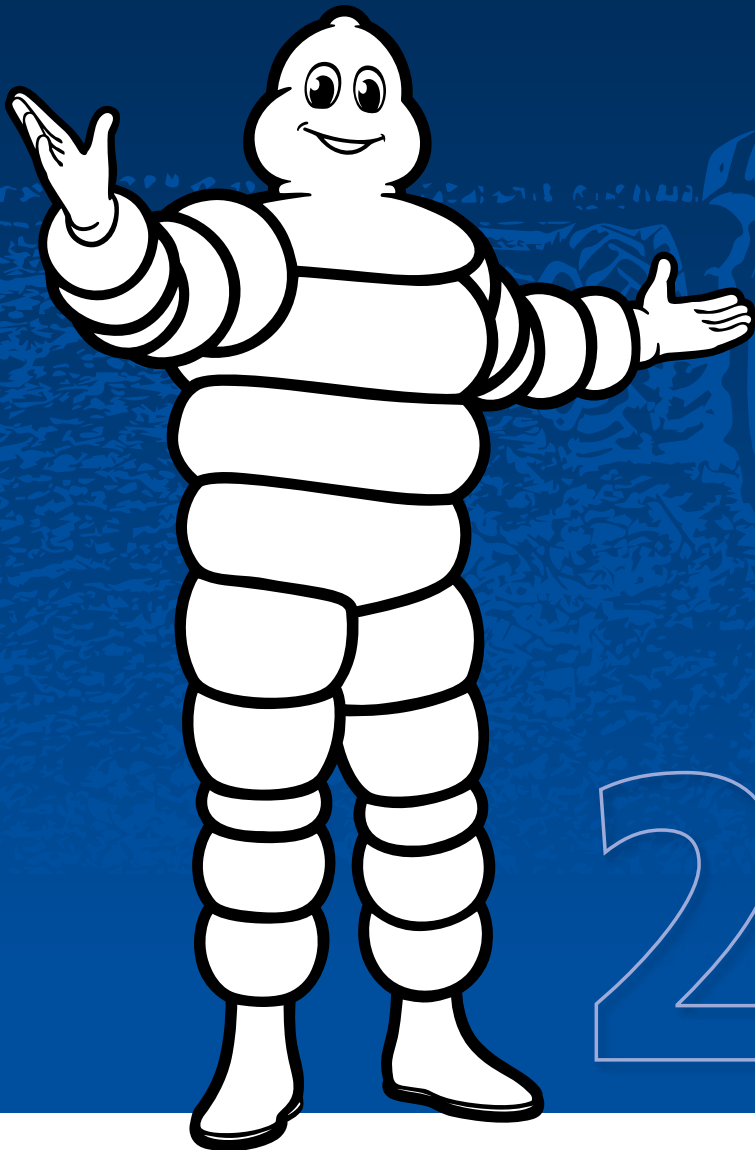

2020

JULIO 2020

 AGRO.MICHELIN.COM

 [MICHELIN AGRICULTURE](https://www.youtube.com/MICHELIN AGRICULTURE)





MICHELIN
PÁGINA 3



COMPACT LINE
PÁGINA 149

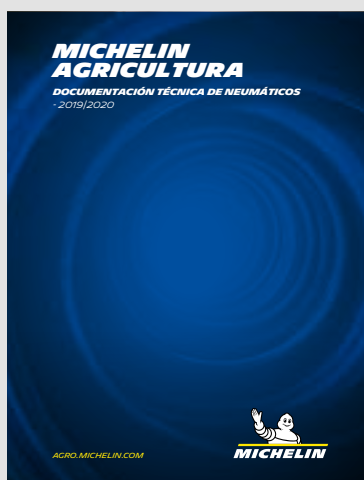

PUESTA EN MARCHA
PÁGINA 191

MICHELIN AGRÍCOLA

**DOCUMENTACIÓN TÉCNICA DE NEUMÁTICOS /
2019/2020**



AGRO.MICHELIN.COM



MICHELIN

CÓMO LEER LOS DATOS TÉCNICOS	5
EQUIVALENCIAS DIMENSIONALES	6
NEUMÁTICOS POR MEDIDA	8
GRÁFICO DE CIRCUNFERENCIA DEL RODAMIENTO	13
ÍNDICE DE CARGA	22
NUEVA CARGA/PRESIÓN	23
TECNOLOGÍAS MICHELIN® ULTRAFLEX	24
LISTA DE NEUMÁTICOS DESCATALOGADOS	25
TRACTORES	26
MICHELIN® EVOBIB	26
MICHELIN® ROADBIB	28
MICHELIN® AXIOBIB 2	32
MICHELIN® AXIOBIB	39
MICHELIN® MACHXBIB	44
MICHELIN® XEOBIB	53
MICHELIN® MULTIBIB	57
MICHELIN® OMNIBIB	65
MICHELIN® YELDBIB	72
MICHELIN® AGRIBIB 2	76
MICHELIN® AGRIBIB	83
COSECHADORAS Y FLOTADORES	95
MICHELIN® CEREXBIB 2	95
MICHELIN® CEREXBIB	101
MICHELIN® FLOATXBIB	107
MICHELIN® MEGAXBIB 2	110
MICHELIN® MEGAXBIB	115
TRATAMIENTO	122
MICHELIN® SPRAYBIB	122
MICHELIN® AGRIBIB ROW CROP	126
REMOLQUES E IMPLEMENTOS	130
MICHELIN® TRAILXBIB	130
MICHELIN® CARGOXBIB HIGH FLOTATION	132
MICHELIN® CARGOXBIB HEAVY DUTY	137
MICHELIN® CARGOXBIB	139
MICHELIN® CARGOXBIB 2	142
MICHELIN® XP 27	144
MICHELIN® XS	146

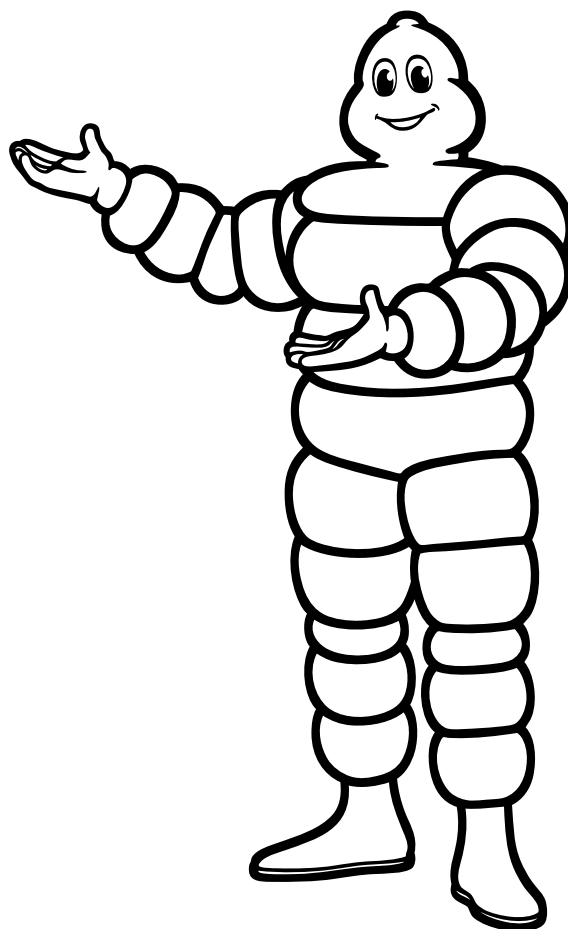

CÓMO LEER LOS DATOS TÉCNICOS

Diagrama de un neumático con las siguientes etiquetas:

- Diámetro de la llantas en pulgadas
- Código de artículo internacional
- (S) Anchura de sección del neumático en mm
- (D) Diámetro exterior en mm
- (R') Radio con carga en estático en mm
- (CdR.) Circunferencia de la banda de rodamiento en mm

Ø Pulgadas	Descripción	CAI	S mm	D mm	R' mm	CdR. mm	Llanta Recomendada	Llanta Permitida	Cámara de aire (Código)	Volumen interno al 75% (litros)	Profundidad de la banda de rodamiento (mm)
30	VF 540/65 R30 158D/155E TL	296638	536	1460	641	4316	W18L	W16L (NRO)	754	332	48

(TL) Sin cámara

Marcajes específicos para neumáticos de alta tecnología

- **IF: Improved Flexion**
(Neumáticos diseñados para llevar un 20% más de carga con la misma presión)
- **VF: Very High Flexion**
(Neumáticos diseñados para llevar un 40% más de carga con la misma presión)
- **CFO & CFO +: Operación de campo cíclico con bonificación de carga**
(Parámetros para operaciones de campo cíclicas para neumáticos con designaciones IF y VF)

Escala de presión en Bar y Psi

Bar	0.4	0.6	0.8	0.9	1	1.1	1.2	1.3	1.4	1.5	1.6	1.7	1.8	1.9	2
Psi	6	9	12	13	15	16	17	19	20	22	23	25	26	28	29
65 km/h		2180	2500	2690	2875	3065	3250	3405	3565	3720	3875	3970	4065	4155	4250
70 km/h		2000	2295	2470	2640	2815	2985	3130	3270	3415	3555	3640	3730	3815	3900
65 km/h Dual		1920	2180	2310	2440	2570	2700	2830	2960	3090	3220	3350	3480	3610	3740

Velocidad de uso en km/h

Carga por neumático en kg



Al pie de las páginas de datos técnicos de cada gama hay notas importantes acerca del uso de los neumáticos.

EQUIVALENCIAS DIMENSIONALES DE LOS NEUMÁTICOS

PASO 1

Determinar el SRI correspondiente considerando la dimensión original.

SRI: «Speed Radius Index» es el parámetro que se utiliza para calcular la velocidad teórica de los vehículos en el proceso de homologación de la Unión Europea y para definir la equivalencia de las diferentes dimensiones de los neumáticos.

Ø	DIMENSIONES	SRI	Ø	DIMENSIONES	SRI	Ø	DIMENSIONES	SRI	Ø	DIMENSIONES	SRI
16	6.50R16	360	26	480/70R26	650	32	210/95R32 (8.3R32)	575	38	580/70R38	875
	7.50R16	390		23.1-26	750		230/95R32 (9.5R32)	600		620/70R38	875
	250/80R16	390		520/80R26	700		270/95R32 (11.2R32)	625		650/65R38	875
	260/70R16	360		540/65R26	650		320/85R32 (12.4R32)	650		650/75R38	925
	280/65R16	360		580/70R26	675		650/75R32 (24.5R32)	825		650/85R38	975
	280/70R16	390		620/70R26	725		680/75R32 (30.5LR32)	875		680/75R38	925
18	320/65R16	390		620/75R26	750		680/85R32	925		710/60R38	875
	7.50R18	410		750/50R26	675		800/65R32	875		710/70R38	925
	280/70R18	410		750/65R26	750		800/70R32	925		710/85R38	1025
	320/65R18	410		9.5R28	550		900/60R32	925		750/65R38	925
	340/65R18	425		250/85R28	550		1000/55R32	875		800/70R38	975
	7.50R20	425		280/85R28 (11.2R28)	575		1050/50R32	875		900/60R38	975
20	9.5R20	450		320/70R28	575		320/85R34	675	40	230/95R40 (9.5R40)	700
	11.2R20	475		320/85R28 (12.4R28)	600		380/85R34	725		270/95R42 (11.2R42)	750
	12.4R20	500		340/65R28	550		420/85R34 (16.9R34)	750		300/95R42 (12.4R42)	800
	13.6R20	525		340/85R28 (13.6R28)	625		460/85R34 (18.4R34)	775		320/90R42	800
	14.9LR20	525		360/70R28	600		480/70R34	750		480/80R42 (18.4R42)	875
	260/80R20	450		380/70R28	625		520/70R34	775		520/85R42 (20.8R42)	925
	280/70R20	425		380/85R28 (14.9R28)	650		520/75R34	775		580/85R42	975
	280/85R20	475		420/65R28	600		540/65R34	750		620/70R42	925
	300/70R20	450	28	420/70R28	650		600/60R34	750	42	650/65R42	925
	320/70R20	475		420/75R28	650		600/65R34	775		650/85R42	1025
	320/85R20	500		420/85R28 (16.9R28)	675		620/75R34	825		710/60R42	925
	340/65R20	450		440/65R28	625		650/60R34	775		710/70R42	975
	340/75R20	500		480/60R28	625		650/65R34	825		710/75R42	1025
	360/70R20	500		480/65R28	650		650/75R34	875		900/50R42	925
	380/70R20	525		480/70R28	675		710/60R34	825		900/60R42	1025
	380/75R20	525		520/60R28	650		710/75R34	925		210/95R44 (8.3R44)	725
	420/65R20	500		540/65R28	675		210/95R36 (8.3R36)	625	44	230/95R44 (9.5R44)	750
	440/65R20	525		600/60R28	675		230/95R36 (9.5R36)	650		270/95R44 (11.2R44)	775
24	8.3R24	475		600/65R28	700		270/95R36 (11.2R36)	675		270/95R46 (11.2R46)	800
	250/85R24 (9.5R24)	500		600/70R28	725		320/85R36 (12.4R36)	700		300/95R46 (12.4R46)	825
	280/85R24 (11.2R24)	525		600/70R28	725		340/85R36 (13.6R36)	725		320/90R46	825
	300/70R24	500		380/85R30 (14.9R30)	675		270/95R38 (11.2R38)	700		340/85R46 (13.6R46)	825
	320/70R24	525		420/70R30	675		320/85R38 (12.4R38)	725		380/90R46	875
	320/85R24 (12.4R24)	550		420/85R30 (16.9R30)	700		340/85R38 (13.6R38)	750		420/80R46	875
	340/85R24 (13.6R24)	575		420/90R30	725		380/80R38	750		480/80R46	925
	360/70R24	550		460/85R30 (18.4R30)	725		380/95R38	800		520/85R46 (20.8R46)	975
	380/70R24	575		480/70R30	700		400/75R38 (15.5R38)	750		620/70R46	975
	380/85R24 (14.9R24)	600		480/75R30	700		420/85R38 (16.9R38)	800		750/75R46	≥ 1075
	400/70R24	575		520/70R30	725		460/85R38 (18.4R38)	825		900/65R46	≥ 1075
	420/65R24	550		520/85R30	775	38	480/70R38	800		230/95R48 (9.5R48)	800
	420/70R24	600		540/65R30	700		520/70R38	825		270/95R48 (11.2R48)	825
	420/85R24 (16.9R24)	625		600/60R30	700		520/85R38 (20.8R38)	875		340/85R48 (13.6R48)	875
	440/65R24	575		600/65R30	725		540/65R38	800		320/90R50	875
	460/70R24	600		600/70R30	750		600/60R38	800		380/90R50	925
	480/65R24	600		620/70R30	775		600/65R38	825		420/95R50	975
	480/70R24	625		620/75R30	800		650/60R38	825		480/80R50	975
500/70R24	625		650/70R30	800		650/60R38	825		480/95R50	1025	
540/65R24	625		650/75R30	800							
25	1000/50R25	750		710/55R30	725				52	300/95R52 (12.4R52)	925
				710/60R30	750					270/95R54 (11.2R54)	925
									54	320/90R54	925
										380/90R54	975

Con base en el SRI obtenido, establecer las posibles equivalencias dimensionales de los neumáticos.

IMPORTANTE:

- En ningún caso corresponde el SRI a un valor específico de la circunferencia de la banda de rodamiento. El SRI presentado en estas tablas es únicamente para fines informativos. Es necesario realizar mediciones de verificación.
- Toda modificación implica calcular la relación del eje, evaluar la distribución del peso, y verificar que el diámetro y la anchura de la llanta sean compatibles (ver páginas técnicas).

SRI	EQUIVALENCIAS	SRI	EQUIVALENCIAS	SRI	EQUIVALENCIAS	SRI	EQUIVALENCIAS
360	6.50R16	625	210/95R36 // 8.3R36	750	230/95R44 // 9.5R44	875 (1.85m)	320/90R50
	260/70R16		270/95R32 // 11.2R32		270/95R42 // 11.2R42		340/85R48 // 13.6R48
	280/65R16		340/85R28 // 13.6R28		340/85R38 // 13.6R38		380/90R46
7.50R16	380/70R28		380/80R38		420/80R46		
390	250/80R16		420/85R24 // 16.9R24		400/75R38 // 15.5R38		480/80R42 // 18.4R42
	280/70R16		440/65R28		420/85R34 // 16.9R34		520/85R38 // 20.8R38
	320/65R16		480/60R28		480/70R34		580/70R38
410	7.50R18		480/70R24		540/65R34		620/70R38
	280/70R18		500/70R24		600/60R34		650/65R38
	320/65R18		540/65R24		600/70R30		650/75R34
425	7.50R20	650	230/95R36 // 9.5R36	620/75R26 // 23.1R26	680/75R32 // 30.5LR32		
	280/70R20		320/85R32 // 12.4R32	710/60R30	710/60R38		
	340/65R18		380/85R28 // 14.9R28	750/65R26	800/65R32		
9.5R20	420/70R28		1000/50R25	1000/55R32			
450	260/80R20		420/75R28	270/95R44 // 11.2R44	1050/50R32		
	300/70R20		480/65R28	460/85R34 // 18.4R34	925 (1.95m)		
	340/65R20		480/70R26	520/85R30		270/95R54 // 11.2R54	
11.2R20	520/60R28		520/70R34	300/95R52 // 12.4R52			
475	280/85R20		540/65R26	520/75R34		320/90R54	
	320/70R20		675	600/65R34		380/90R50	
	8.3R24	270/95R36 // 11.2R36		480/80R46			
250/85R24 // 9.5R24	320/85R34 // 12.4R34	520/85R42 // 20.8R42					
300/70R24	380/85R30 // 14.9R30	620/70R42					
500	320/85R20 // 12.4R24	420/70R30		650/60R34		650/65R42	
	340/75R20	420/85R28 // 16.9R28		800		650/75R38	
	360/70R20	480/70R28			680/75R38		
420/65R20	540/65R28	680/85R32					
280/85R24 // 11.2R24	580/70R26	710/60R42					
320/70R24	600/60R28	710/70R38					
525	380/70R20	750/50R26	710/75R34				
	380/75R20 // 13.6R20	700	750/65R38				
	14.9LR20		230/95R40 // 9.5R40		750/65R32		
440/65R20	270/95R38 // 11.2R38		800/70R32				
250/85R28 // 9.5R28	320/85R36 // 12.4R36		900/50R42				
320/85R24 // 12.4R24	420/85R30 // 16.9R30		900/60R32				
550	340/65R28		480/70R30	975 (2.05m)	380/90R54		
	360/70R24		480/75R30		420/95R50		
	420/65R24		520/80R26		480/80R50		
210/95R32 // 8.3R32	540/65R30		520/85R46 // 20.8R46				
280/85R28 // 11.2R28	600/60R30		580/85R42				
320/70R28	600/65R28	620/70R46					
575	340/85R24 // 13.6R24	725	210/95R44 // 8.3R44		650/85R38		
	380/70R24		320/85R38 // 12.4R38		620/70R42		
	400/70R24		340/85R36		800/70R38		
440/65R24	380/85R34		900/60R38				
600	230/95R32 // 9.5R32		460/85R30 // 18.4R30	520/70R38	480/95R50		
	320/85R28 // 12.4R28		520/70R30	600/65R38	650/85R42		
	360/70R28		600/65R30	620/75R34	710/70R42		
	380/85R24 // 14.9R24		600/70R28	650/75R32 // 24.5R32	800/70R38		
	420/65R28		620/70R26	650/65R34	900/60R38		
	420/70R24		710/55R30	650/60R38	480/95R50		
	460/70R24	825 (1.75m)	270/95R48 // 11.2R48	650/85R42			
480/65R24	300/95R46 // 12.4R46		620/70R46				
	320/90R46		650/85R38				
	340/85R46 // 13.6R46		710/70R42				
	460/85R38 // 18.4R38		800/70R38				
	520/70R38		900/60R38				
	600/65R38		480/95R50				
	620/75R34		650/85R42				
	650/75R32 // 24.5R32		710/75R42				
	650/65R34		710/85R38				
	650/60R38	900/60R42					
	710/60R34	≥ 1075 (2.30m)	750/75R46				
			900/65R46				

NEUMÁTICOS POR MEDIDA

RIN	MEDIDA	EVOBIB	ROADBIB	AXIOBIB 2	AXIOBIB	MACHXBIB	XEOBIB	MULTIBIB	OMNIBIB	YELDBIB	AGRIBIB 2	AGRIBIB	CEREXBIB 2	CEREXBIB	FLOATXBIB	MEGAXBIB 2	MEGAXBIB	SPRAYBIB	AGRIBIB RC	CARGO HF	CARGO HD	CARGOXBIB	XP27	XS	
16	270/65 R16																						x		
16	280/70 R16								x																
16	320/65 R16							x																	
18	270/65 R18																							x	
18	320/65 R18							x																	
18	340/65 R18							x																x	
20	280/70 R20								x																
20	420/65 R20							x																	
20	440/65 R20							x																	
20.5	24 R 20.5																								x
20.5	525/65 R 20.5																								x
22.5	500/60 R22.5																					x			
22.5	560/45 R22.5																					x			
22.5	560/60 R22.5																					x			
22.5	600/50 R22.5																						x		
22.5	710/45 R22.5																			x					
24	11.2 R24											x													
24	12.4 R24											x													
24	13.6 R24											x													
24	14.9 R24											x													
24	16.9 R24											x													
24	320/70 R24								x																
24	360/70 R24								x																
24	380/70 R24								x																
24	420/65 R24							x																	
24	420/70 R24								x																
24	440/65 R24							x																	
24	480/65 R24								x																
24	480/70 R24								x																
24	540/65 R24							x																	
24	9.5 R24											x													
25	1000/50 R25															x									
26	28 LR 26																				x				
26	520/80 R26												VF	VF											
26	620/70 R26					x							VF	VF											
26	620/75 R26																x								
26	750/50 R26															x	x								

NEUMÁTICOS POR MEDIDA

RIN	MEDIDA	EVOBIB	ROADBIB	AXIOBIB 2	AXIOBIB	MACHXBIB	XEOBIB	MULTIBIB	OMNIBIB	YELDBIB	AGRIBIB 2	AGRIBIB	CEREXBIB 2	CEREXBIB	FLOATXBIB	MEGAXBIB 2	MEGAXBIB	SPRAYBIB	AGRIBIB RC	CARGO HF	CARGO HD	CARGOXBIB	XP27	XS
26	750/65 R26												VF	VF			x							
26.5	600/55 R26.5																			VF				
26.5	650/55 R26.5																			VF				
26.5	710/50 R26.5																			VF				
26.5	800/45 R26.5																						x	
28	12.4 R28											x												
28	13.6 R28											x												
28	14.9 R28											x												
28	16.9 R28											x												
28	280/85 R28										x													
28	380/70 R28								x															
28	420/65 R28							x																
28	420/70 R28								x															
28	440/65 R28							x																
28	480/60 R28						VF																	
28	480/65 R28							x																
28	480/70 R28								x															
28	520/60 R28						VF																	
28	540/65 R28							x																
28	600/60 R28						VF																	
28	600/65 R28					x																		
28	600/70 R28					x																		
30	16.9 R30											x												
30	18.4 R30											x												
30	380/85 R30										x	x												
30	420/90 R30										x	x												
30	480/70 R30								x															
30	520/85 R30												VF	VF										
30	540/65 R30			VF				x																
30	600/60 R30			VF			VF																	
30	600/70 R30	VF	x	VF	IF	x																		
30	620/70 R30												VF	VF										
30	620/75 R30			VF	IF												x							
30	650/75 R30				IF																			
30	710/55 R30					x																		
30	710/65 R30												VF											

NEUMÁTICOS POR MEDIDA

RIN	MEDIDA	EVOBIB	ROADBIB	AXIOBIB 2	AXIOBIB	MACHXBIB	XEOBIB	MULTIBIB	OMNIBIB	YELDBIB	AGRIBIB 2	AGRIBIB	CEREXBIB 2	CEREXBIB	FLOATXBIB	MEGAXBIB 2	MEGAXBIB	SPRAYBIB	AGRIBIB RC	CARGO HF	CARGO HD	CARGOXBIB	XP27	XS	
30.5	600/60 R30.5																							x	
30.5	650/65 R30.5																				x				
30.5	710/50 R30.5																								x
30.5	750/60 R30.5																				VF				
30.5	800/45 R30.5																								x
30.5	850/50 R30.5																								x
32	1000/55 R32													IF	IF										
32	1050/50 R32															x	x								
32	650/75 R32															x									
32	680/75 R32					x																			
32	680/85 R32													IF											
32	800/60 R32																				x				
32	800/65 R32												IF	IF		x									
32	800/70 R32												IF	IF			x								
32	900/60 R32												VF	IF		x									
34	18.4 R34											x													
34	320/85 R34										x	x													
34	380/85 R34									VF	x	x													
34	420/85 R34									VF	x	x													
34	480/70 R34							x																	
34	500/85 R34												VF												
34	520/70 R34							x																	
34	540/65 R34							x																	
34	600/60 R34						VF																		
34	600/65 R34							x																	
34	620/75 R34																x								
34	650/60 R34			VF	IF	x																			
34	650/65 R34	VF		VF	IF	x																			
34	710/60 R34				IF																				
34	710/75 R34																x								
36	12.4 R36											x													
38	12.4 R38											x													
38	13.6 R38											x													
38	18.4 R38											x													
38	20.8 R38											x													
38	320/85 R38																				x				

NEUMÁTICOS POR MEDIDA

RIN	MEDIDA	EVOBIB	ROADBIB	AXIOBIB 2	AXIOBIB	MACHXBIB	XEOBIB	MULTIBIB	OMNIBIB	YIELDBIB	AGRIBIB 2	AGRIBIB	CEREXBIB 2	CEREXBIB	FLOATXBIB	MEGAXBIB 2	MEGAXBIB	SPRAYBIB	AGRIBIB RC	CARGO HF	CARGO HD	CARGOXBIB	XP27	XS	
38	380/80 R38									VF	x	x						VF							
38	380/95 R38									VF		x													
38	420/85 R38										x														
38	480/70 R38								x																
38	520/70 R38								x																
38	520/85 R38										x	x													
38	540/65 R38							x																	
38	580/70 R38								x																
38	600/60 R38						VF																		
38	600/65 R38							x																	
38	620/70 R38																x								
38	650/60 R38			VF			VF																		
38	650/65 R38				IF			x																	
38	650/75 R38					x																			
38	650/85 R38			VF	IF	x																			
38	680/75 R38													IF											
38	680/80 R38												IF												
38	710/60 R38				IF		VF																		
38	710/70 R38					x																			
38	710/85 R38				IF																				
38	800/70 R38			VF	IF	x							IF	IF											
38	900/60 R38												VF	IF											
42	320/90 R42																	VF	x						
42	480/80 R42										x	x						VF							
42	520/85 R42										x	x	VF	VF			x								
42	580/85 R42												VF												
42	620/70 R42								x								x								
42	650/60 R42						x																		
42	650/65 R42			VF				x																	
42	650/85 R42			VF																					
42	710/60 R42			VF			VF																		
42	710/70 R42	VF	x	VF	IF	x							VF	IF											
42	710/75 R42	VF		VF	IF	x																			
42	800/70 R42												IF												
42	900/50 R42					x																			
42	900/60 R42				IF								VF												

NEUMÁTICOS POR MEDIDA

RIN	MEDIDA	EVOBIB	ROADBIB	AXIOBIB 2	AXIOBIB	MACHXBIB	XEOBIB	MULTIBIB	OMNIBIB	YELDBIB	AGRIBIB 2	AGRIBIB	CEREXBIB 2	CEREXBIB	FLOATXBIB	MEGAXBIB 2	MEGAXBIB	SPRAYBIB	AGRIBIB RC	CARGO HF	CARGO HD	CARGOXBIB	XP27	XS
44	750/70 R44			VF																				
46	340/85 R46																		x					
46	380/90 R46																	VF	x					
46	420/80 R46										x	x												
46	480/80 R46									VF	x	x						VF						
46	520/85 R46										x	x												
46	620/70 R46					x																		
46	750/75 R46				IF																			
46	900/65 R46				IF																			
50	320/90 R50																	VF	x					
50	380/90 R50																	VF	x					
50	420/95 R50																	VF						
50	480/80 R50									VF	x	x						VF						
50	480/95 R50									VF		x												
54	320/90 R54																	VF	x					
54	380/90 R54										x							VF						

GRÁFICO DE CIRCUNFERENCIA DEL RODAMIENTO

MEDIDA Y MODELO DEL NEUMÁTICO	CAI	MSPN	Mínimo espacio doble		Diámetro del neumático		Circunferencia del rodamiento		RCI	SRI
			mm	Pol.	mm	Pol.	mm	Pol.		
210/70 R15 117A8/117B IND TL BIBSTEEL ALL TERRAIN	085459	20011	308	12,1	680	26,8	2033	80,0		320
270/65 R16 134A8/122A8 TL XP27	184332	04629	369	14,5	755	29,7	2300	90,6		360
260/70 R16.5 129A8/129B IND TL BIBSTEEL HARD SURFACE	275538	38281	364	14,3	773	30,4	2307	90,8		370
260/70 R16.5 129A8/129B IND TL BIBSTEEL ALL TERRAIN	176281	19038	364	14,3	774	30,5	2310	90,9		370
280/70 R 16 112D TL OMNIBIB	747196		389	15,3	805	31,7	2400	94,5	30	390
250/80 R16 124A8/120D IND TL CROSSGRIP	564847	97221	352	13,9	804	31,7	2402	94,6		390
320/65 R16 107D TL MULTIBIB	494658	39517	410	16,1	827	32,6	2452	96,5		390
270/65 R18 136A8/124A8 TL XP27	133069	98595	369	14,5	810	31,9	2472	97,3		390
300/70 R16.5 137A8/137B IND TL BIBSTEEL HARD SURFACE	241265	84590	414	16,3	830	32,7	2477	97,5		400
300/70 R16.5 137A8/137B IND TL BIBSTEEL ALL TERRAIN	625787	34034	414	16,3	832	32,8	2481	97,7		400
11 LR16 122A8 IND TL XM27	123207	13902	386	15,2	850	33,5	2515	99,0		
320/65 R18 109A8/106B TL XM108	123898	78520	422	16,6	875	34,4	2594	102,1		410
280/70 R20 116D TL OMNIBIB	263806		389	15,3	904	35,6	2690	105,9	32	450
280/80 -18 132A8 IND TL POWER CL	281778	38882	348	13,7	902	35,5	2691	105,9		425
280/80 R18 132A8/132B IND TL XMCL	779803	25391	389	15,3	908	35,7	2708	106,6		425
340/65 R18 113A8/110B TL XM108	123888	79647	438	17,2	911	35,9	2719	107,0	32	425
340/65 R18 149A8/137A8 TL XP27	415969	08185	462	18,2	891	35,1	2720	107,1		425
360/70 R17.5 148A8/148B IND TL BIBSTEEL ALL TERRAIN	360353	17395	472	18,6	949	37,4	2823	111,1	33	450
280/80 -20 133A8 IND TL POWER CL	694767	28486	348	13,7	947	37,3	2828	111,3		450
280/80 R20 133A8/133B IND TL XMCL	747442	32621	389	15,3	958	37,7	2860	112,6		450
340/80 R18 143A8/143B IND TL BIBLOAD HARD SURFACE	415829	66605	462	18,2	990	39,0	2946	116,0		475
340/80 R18 143A8/143B IND TL XMCL	100054	24643	462	18,2	996	39,2	2959	116,5		475
400/70 R18 147A8/147B IND TL BIBLOAD HARD SURFACE	239365	09464	536	21,1	1006	39,6	2983	117,4		475
340/80 -18 143A8 IND TL POWER CL	610873	04967	415	16,3	1006	39,6	2988	117,6		475
400/70 R18 147A8/147B IND TL XMCL	133035	39817	536	21,1	1013	39,9	3008	118,4		475
335/80 R18 151A2/139B TL XZSL	122999	44533	459	18,1	995	39,2	3020	118,9		
340/80 R20 144A8/144B IND TL BIBLOAD HARD SURFACE	991253	23767	462	18,2	1041	41,0	3100	122,0		500
340/80 -20 144A8 IND TL POWER CL	495503	56730	415	16,3	1045	41,1	3112	122,5		500
9.5 R24 112A8/109B TL AGRIBIB	200987		340	13,4	1045	41,1	3117	122,7	35	500
340/80 R20 144A8/144B IND TL XMCL	948730	00733	462	18,2	1047	41,2	3119	122,8		500
420/65 R20 125A8/125B TL XM108	122702	86582	528	20,8	1064	41,9	3135	123,4	35	500
10.00-20 165A2/147B 16PR TT POWER DIGGER	263208	03227	341	13,4	1050	41,3	3144	123,8		
400/70 -20 149A8 IND TL POWER CL	346809	18007	483	19,0	1065	41,9	3167	124,7		525
400/70 R20 149A8/149B IND TL BIBLOAD HARD SURFACE	793611	18143	536	21,1	1068	42,0	3174	125,0		525
400/70 R20 149A8/149B IND TL XMCL	474495	02871	536	21,1	1069	42,1	3177	125,1		525
380/75 R20 148A8/148B IND TL XMCL	187752	03424	507	20,0	1070	42,1	3180	125,2		525
560/45 R22.5 152D TL CARGOXBIB HEAVY DUTY	743789	27334	702	27,6	1080	42,5	3191	125,6		525

GRÁFICO DE CIRCUNFERENCIA DEL RODAMIENTO

MEDIDA Y MODELO DEL NEUMÁTICO	CAI	MSPN	Mínimo espacio doble		Diámetro del neumático		Circunferencia del rodamiento		RCI	SRI
			mm	Pol.	mm	Pol.	mm	Pol.		
405/70 R20 136G TL XM47	123708	43043	515	20,3	1076	42,4	3194	125,7		
335/80 R20 153A2/141B TL XZSL	792581	65249	459	18,1	1068	42,0	3235	127,4		
375/75 R20 155A2/143B TL XZSL	122989	57791	503	19,8	1067	42,0	3241	127,6		
440/65 R20 128D TL MULTIBIB	675464	15810	580	22,8	1090	42,9	3260	128,3		525
11.2 R24 119A8/116B TL AGRIBIB	317247	92311	392	15,4	1095	43,1	3269	128,7	36	525
320/70 R24 116D TL OMNIBIB	415039	25416	434	17,1	1101	43,3	3274	128,9		525
405/70 R20 155A2/143B TL XZSL	753584	94628	539	21,2	1103	43,4	3314	130,5		
445/70 R19.5 173A8/180A2 TL XF	489102	81617	585	23,0	1110	43,7	3331	131,1		
420/75 R20 154A8/154B IND TL XMCL	967201	19152	552	21,7	1138	44,8	3378	133,0		550
425/75 R20 148G TL XM47	123706	75328	556	21,9	1147	45,2	3398	133,8		
420/65 R 24 126D TL MULTIBIB	171560		540	21,3	1156	45,5	3416	134,5	37	550
360/70 R24 122D TL OMNIBIB	198698	45416	479	18,9	1153	45,4	3418	134,6	37	550
12.4 R24 119A8/116B TL AGRIBIB	123788	78449	429	16,9	1149	45,2	3420	134,6	37	550
420/65 R24 126A8/126B TL XM108	122712	77842	528	20,8	1160	45,7	3425	134,8	37	550
425/75 R20 167A2/155B TL XZSL	122979	64875	556	21,9	1142	45,0	3439	135,4		
500/60 R22.5 155D TL CARGOXBIB HEAVY DUTY	441880	36343	654	25,7	1172	46,1	3454	136,0		550
600/50 R22.5 159D TL CARGOXBIB	048429	94336	784	30,9	1181	46,5	3478	136,9		550
400/70 R24 152A8/152B IND TL XMCL	178690	92225	536	21,1	1170	46,1	3485	137,2	37	575
400/70 -24 158A8 IND TL POWER CL	407878	60752	483	19,0	1173	46,2	3497	137,7	37	575
440/65 R24 128D TL MULTIBIB	426389	04039	580	22,8	1187	46,7	3519	138,5		575
380/70 R24 125D TL OMNIBIB	085816	64778	507	20,0	1188	46,8	3520	138,6	38	575
710/45 R22.5 165D TL CARGOXBIB HIGH FLOTATION	723051	06153	922	36,3	1208	47,6	3545	139,6		575
710/45 R22.5 165D TL CARGOXBIB	064190	49366	922	36,3	1210	47,6	3552	139,8		575
280/85 R28 123A8/120D TL AGRIBIB 2	392931	40217	401	15,8	1192	46,9	3563	140,3		575
445/70 R22.5 175A8/182A2 TL XF	073522	33819	585	23,0	1192	46,9	3582	141,0		
13.6 R24 124A8/121B TL AGRIBIB	262831	06247	465	18,3	1200	47,2	3583	141,1	38	575
525/65 R 20.5 XS TL 173F MI	109421	71848	687	27,0	1200	47,2	3640	143,3		575
560/60 R22.5 161D TL CARGOXBIB HEAVY DUTY	102433	20379	704	27,7	1242	48,9	3650	143,7		600
480/65 R24 133D TL MULTIBIB	531721	03176	626	24,6	1240	48,8	3667	144,4	38	600
560/60 R22.5 161D TL CARGOXBIB	775457	75840	716	28,2	1251	49,3	3678	144,8		600
420/65 R28 135D TL MULTIBIB	778211	62700	528	20,8	1238	48,7	3680	144,9		600
460/70 -24 159A8 IND TL POWER CL	474764	86617	550	21,7	1241	48,9	3687	145,2		600
460/70 R24 159A8/159B IND TL BILLOAD HARD SURFACE	372690	27534	609	24,0	1241	48,9	3688	145,2		600
445/70 R24 151G TL XM47	123642	45627	597	23,5	1239	48,8	3689	145,2		
420/70 R24 130D TL OMNIBIB	829095	28067	552	21,7	1251	49,3	3702	145,7	39	600
460/70 R24 159A8/159B IND TL XMCL	244268	70333	609	24,0	1248	49,1	3709	146,0		600
360/70 R28 125D TL OMNIBIB	534919		479	18,9	1260	49,6	3737	147,1		600

GRÁFICO DE CIRCUNFERENCIA DEL RODAMIENTO

MEDIDA Y MODELO DEL NEUMÁTICO	CAI	MSPN	Mínimo espacio doble		Diámetro del neumático		Circunferencia del rodamiento		RCI	SRI
			mm	Pol.	mm	Pol.	mm	Pol.		
400/80 -24 162A8 IND TL POWER CL	050267	53837	483	19,0	1257	49,5	3743	147,4		600
400/80 R24 156A8/151D IND TL CROSSGRIP	920345	76135	536	21,1	1240	48,8	3747	147,5		600
14.9 R24 130A8/127B TL AGRIBIB	601563	92158	504	19,8	1265	49,8	3769	148,4	39	600
460/70 R24 159A8/154D IND TL CROSSGRIP	304047	11050	609	24,0	1246	49,1	3772	148,5		600
12.4 R28 126A8/123B TL AGRIBIB	738964	20895	429	16,9	1265	49,8	3778	148,7		600
VF 480/60 R28 134D TL XEOBIB	312875	80140	615	24,2	1298	51,1	3831	150,8	39	625
440/65 R28 131D TL MULTIBIB	386212	96372	580	22,8	1291	50,8	3833	150,9	39	625
380/70 R28 127D TL OMNIBIB	118587	24723	507	20,0	1294	50,9	3842	151,3	39	625
440/80 R24 161A8/161B IND TL BIBLOAD HARD SURFACE	814805	23762	580	22,8	1299	51,1	3860	152,0		625
500/70 R24 164A8/164B IND TL XMCL	542794	89582	654	25,7	1302	51,3	3866	152,2		625
540/65 R24 140D TL MULTIBIB	097057	08801	687	27,0	1312	51,7	3873	152,5		625
500/70 R24 164A8/164B IND TL BIBLOAD HARD SURFACE	346709	19122	654	25,7	1299	51,1	3874	152,5		625
495/70 R24 155G TL XM47	123620	88892	650	25,6	1311	51,6	3883	152,9		
13.6 R28 123A8/120B TL AGRIBIB	123782	87976	465	18,3	1308	51,5	3893	153,3	39	625
500/70 -24 164A8 IND TL POWER CL	196220	06567	591	23,3	1315	51,8	3903	153,7		625
440/80 R24 161A8/161B IND TL XMCL	954749	34933	580	22,8	1314	51,7	3907	153,8		625
480/70 R24 138D TL OMNIBIB	375821	02475	626	24,6	1327	52,2	3916	154,2		625
VF600/55 R26.5 170D IMP TL CARGOXBIB HF	377726		784	30,9	1341	52,8	3923	154,4		625
16.9 R24 134A8/131B TL AGRIBIB	123854	97341	566	22,3	1330	52,4	3935	154,9		625
VF 520/60 R28 138D TL XEOBIB	510495	80236	670	26,4	1338	52,7	3942	155,2	40	650
440/80 -24 168A8 IND TL POWER CL	165629	56443	523	20,6	1328	52,3	3944	155,3		625
600/55 R26.5 165D TL CARGOXBIB HIGH FLOTATION	550621	32505	784	30,9	1341	52,8	3954	155,7		625
480/65 R28 136D TL MULTIBIB	897574	14369	626	24,6	1339	52,7	3970	156,3		650
600/55 R26.5 165D TL CARGOXBIB	678570	42913	784	30,9	1348	53,1	3976	156,5		625
440/80 R24 161A8/156D IND TL CROSSGRIP	131846	74806	580	22,8	1314	51,7	3977	156,6		625
540/70 R24 168A8/168B IND TL BIBLOAD HARD SURFACE	005412	34928	711	28,0	1341	52,8	3981	156,7	40	650
420/70 R28 133D TL OMNIBIB	532215	25705	552	21,7	1354	53,3	4012	158,0	40	650
VF710/50 R26,5 176D IMP TL CARGOXBIB HF	343405		922	36,3	1380	54,3	4022	158,3		650
540/70 R24 168A8/168B IND TL XMCL	959128	58268	711	28,0	1356	53,4	4026	158,5	40	650
710/50 R26.5 170D TL CARGOXBIB HIGH FLOTATION	892516	29880	922	36,3	1380	54,3	4061	159,9		650
14.9 R28 134A8/131B TL AGRIBIB	112235	25543	504	19,8	1365	53,7	4072	160,3	40	650
VF650/55 R26,5 174D IMP TL CARGOXBIB HF	776393		825	32,5	1402	55,2	4084	160,8		725
400/80 R28 158A8/153D IND TL CROSSGRIP	219659	38141	536	21,1	1354	53,3	4094	161,2	40	650
800/45 R26.5 174D TL CARGOXBIB	248959	81371	996	39,2	1395	54,9	4097	161,3		675
24 R 20.5 XSTL 176F MI	109174	44650	778	30,6	1374	54,1	4148	163,3		650
650/55 R26.5 169D TL CARGOXBIB HIGH FLOTATION	693431	15666	825	32,5	1402	55,2	4158	163,7		725
750/50 R26 160A8/154D TL MEGAXBIB 2	236906	81321	968	38,1	1406	55,4	4171	164,2	41	675

GRÁFICO DE CIRCUNFERENCIA DEL RODAMIENTO

MEDIDA Y MODELO DEL NEUMÁTICO	CAI	MSPN	Mínimo espacio doble		Diámetro del neumático		Circunferencia del rodamiento		RCI	SRI
			mm	Pol.	mm	Pol.	mm	Pol.		
440/80 R28 163A8/163B IND TL BIBLOAD HARD SURFACE	195802	49461	580	22,8	1407	55,4	4188	164,9		675
380/85 R30 135A8/135B TL AGRIBIB	836509	18784	519	20,4	1416	55,7	4194	165,1	41	675
VF 600/60 R28 146D TL XEOBIB	665184	80297	755	29,7	1429	56,3	4198	165,3	41	675
440/80 R28 156A8/156B IND TL XMCL	316223	94482	580	22,8	1410	55,5	4200	165,4		675
440/80-28 163 A8 TL POWER CL	691578	95541	534	21,0	1412	55,6	4201	165,4		675
480/80 -26 167A8 IND TL POWER CL	226486	32114	576	22,7	1417	55,8	4211	165,8		675
480/80 R26 167A8/167B IND TL BIBLOAD HARD SURFACE	886709	46166	638	25,1	1419	55,9	4215	165,9		675
480/70 R28 140D TL OMNIBIB	570026	27084	626	24,6	1427	56,2	4217	166,0	41	675
480/80 R26 167A8/167B IND TL XMCL	425979	22312	626	24,6	1422	56,0	4218	166,1		675
380/85 R30 140A8/140B TL AGRIBIB 2	151572	72163	519	20,4	1416	55,7	4219	166,1	41	675
540/65 R28 142D TL MULTIBIB	792274	36062	687	27,0	1427	56,2	4223	166,3	41	675
320/85 R34 133A8/130B TL AGRIBIB	122760	73532	434	17,1	1420	55,9	4239	166,9	41	675
320/85 R34 133A8/133B TL AGRIBIB 2	908266		434	17,1	1421	55,9	4243	167,0	41	675
16.9 R28 141A8/138B TL AGRIBIB	984997	13991	566	22,3	1435	56,5	4278	168,4	41	675
440/80 R28 163A8/158D IND TL CROSSGRIP	439765	52613	580	22,8	1410	55,5	4283	168,6		675
420/80 -30 155A8 IND TL POWER CL	577845	29803	520	20,5	1432	56,4	4296	169,1		675
VF 540/65 R30 158D/155E TL AXIOBIB 2	296638	06869	686	27,0	1460	57,5	4316	169,9		700
VF 600/60 R30 162D/159E TL AXIOBIB 2	371968	06116	755	29,7	1468	57,8	4336	170,7	42	700
540/65 R30 143D TL MULTIBIB	223153	28553	687	27,0	1472	58,0	4353	171,4		700
12.4 R36 124A8/121B TL AGRIBIB	123952	03338	429	16,9	1460	57,5	4363	171,8	41	700
VF 600/60 R30 147D TL XEOBIB	065253	03690	755	29,7	1493	58,8	4379	172,4	42	700
480/70 R30 141D TL OMNIBIB	599351	27236	626	24,6	1482	58,3	4388	172,8	42	700
16.9 R30 137A8/134B TL AGRIBIB	123870	41545	566	22,3	1480	58,3	4395	173,0	42	700
VF 520/80 R26 CFO 168A8 TL CEREXBIB	972024	61911	658	25,9	1491	58,7	4397	173,1		700
VF 520/80 R26 CFO+ 168A8 TL CEREXBIB 2	850494	24394	658	25,9	1491	58,7	4400	173,2		700
710/50 R30.5 173D TL CARGOXBIB	002786	92209	922	36,3	1495	58,9	4408	173,5		700
800/45 R30.5 176D TL CARGOXBIB	932951	53255	1044	41,1	1495	58,9	4408	173,5		725
VF 620/70 R26 170A8 TL CEREXBIB	921769	18765	778	30,6	1503	59,2	4416	173,9	42	725
600/60 R30.5 169D TL CARGOXBIB	236518	51915	755	29,7	1496	58,9	4417	173,9		700
600/65 R28 154D TL MACHXBIB	055335	30734	784	30,9	1502	59,1	4449	175,2	42	700
VF 620/70 R26 CFO 173A8 TL CEREXBIB	656967	64298	778	30,6	1513	59,6	4458	175,5	42	725
380/85 R34 137A8/137B TL AGRIBIB	122781	59412	507	20,0	1503	59,2	4461	175,6	42	725
VF 620/70 R26 CFO+ 173A8 TL CEREXBIB 2	228272	98039	778	30,6	1513	59,6	4461	175,6	42	725
VF 380/85 R34 149A8/149B TL YIELDBIB	305457	91239	498	19,6	1510	59,4	4471	176,0	42	725
12.4 R38 131A8/128B TL AGRIBIB	258138	15336	429	16,9	1500	59,1	4484	176,5	42	725
710/55 R30 153D TL MACHXBIB	992342	03784	910	35,8	1518	59,8	4489	176,7		725
420/90 R30 147A8/147B TL AGRIBIB 2	508522	71308	552	21,7	1518	59,8	4513	177,7	42	700

GRÁFICO DE CIRCUNFERENCIA DEL RODAMIENTO

MEDIDA Y MODELO DEL NEUMÁTICO	CAI	MSPN	Mínimo espacio doble		Diámetro del neumático		Circunferencia del rodamiento		RCI	SRI
			mm	Pol.	mm	Pol.	mm	Pol.		
320/85 R38 143A8/143B TL AGRIBIB RC	758001	50528	434	17,1	1508	59,4	4514	177,7	42	725
380/85 R34 142A8/142B TL AGRIBIB 2	009860	84143	519	20,4	1516,4	59,7	4519	177,9	42	725
420/90 R30 147A8/147B TL AGRIBIB	953332	68713	552	21,7	1533	60,4	4556	179,4	42	700
18.4 R30 142A8/139B TL AGRIBIB	123844	42060	611	24,1	1550	61,0	4602	181,2		725
VF 600/70 R30 165D TL EVOBIB	266793	84559	774	30,5	1574	62,0	4616	181,7		750
600/70 R30 158D/155E TL ROADBIB	217911	15131	784	30,9	1569	61,8	4630	182,3	43	750
540/65 R34 145D TL MULTIBIB	712064	22243	687	27,0	1574	62,0	4655	183,3	43	750
VF 600/70 R30 168D/165E TL AXIOBIB 2	426719	32376	774	30,5	1579	62,2	4659	183,4		750
600/70 R28 157D TL MACHXBIB	438598	04339	784	30,9	1572	61,9	4663	183,6		725
VF 420/85 R34 154A8/154B TL YIELDBIB	012445	58965	566	22,3	1582	62,3	4682	184,3	43	750
IF 600/70 R30 159D TL AXIOBIB	280086	96393	774	30,5	1585	62,4	4683	184,4	43	750
28 LR 26 175D TL CARGOXBIB HIGH FLOTATION	224829		908	35,7	1581	62,2	4685	184,4	43	
VF 600/60 R34 149D TL XEOBIB	664777	78329	755	29,7	1595	62,8	4699	185,0	43	750
13.6 R38 128A8/125B TL AGRIBIB	123992	66666	465	18,3	1565	61,6	4705	185,2	43	750
VF 380/80 R38 167D TL SPRAYBIB	352109		510	20,1	1577	62,1	4712	185,5	43	750
540/65 R34 152D TL MULTIBIB	214036	99445	687	27,0	1590	62,6	4716	185,7	43	750
480/70 R34 143D TL OMNIBIB	280033	25021	626	24,6	1593	62,7	4728	186,1	43	750
420/85 R34 147A8/147B TL AGRIBIB 2	183733	16801	576	22,7	1589	62,6	4730	186,2	43	750
600/70 R30 TL 152D MACHXBIB	334318	76077	784	30,9	1605	63,2	4745	186,8	43	750
620/75 R26 166A8/166B TL MEGAXBIB	614320	89936	801	31,5	1602	63,1	4748	186,9	43	750
420/85 R34 147A8/147B TL AGRIBIB	788910	30127	576	22,7	1595	62,8	4751	187,0	43	750
380/80 R38 142A8/139D TL AGRIBIB 2	187095	59112	507	20,0	1595	62,8	4755	187,2	43	750
VF 620/70 R30 CFO 172A8 TL CEREXBIB	886789	92780	778	30,6	1615	63,6	4760	187,4		775
VF 620/70 R30 CFO+ 175A8 TL CEREXBIB 2	049288	53106	778	30,6	1615	63,6	4765	187,6		775
650/65 R30.5 176D TL CARGOXBIB HIGH FLOTATION	139310	28171	825	32,5	1622	63,9	4776	188,0		775
650/65 R30.5 176D TL CARGOXBIB	250129	94604	825	32,5	1623	63,9	4776	188,0		775
850/50 R30.5 182D TL CARGOXBIB	938016	69986	1085	42,7	1628	64,1	4778	188,1		775
VF 750/65 R26 CFO 177A8 TL CEREXBIB	811382	02320	932	36,7	1623	63,9	4780	188,2		750
VF 750/65 R26 CFO+ 180A8 TL CEREXBIB 2	132266	33777	932	36,7	1623	63,9	4786	188,4		750
VF 520/85 R30 CFO 172A8 TL CEREXBIB	795916	66188	658	25,9	1624	63,9	4794	188,7	46	775
VF 520/85 R30 CFO+ 172A8 TL CEREXBIB 2	188276	86907	658	25,9	1624	63,9	4797	188,9	46	775
750/65 R26 171A8/171B TL MEGAXBIB	983217	36798	968	38,1	1621	63,8	4818	189,7		750
VF 380/80 R38 149A8/149B TL YIELDBIB	870363	35470	498	19,6	1592	62,7	4851	191,0	43	750
VF750/60 R30,5 187D IMP TL CARGOXBIB HF	139588		956	37,6	1674	65,9	4875	191,9		800
520/70 R34 148D TL OMNIBIB	939411	29601	652	25,7	1651	65,0	4887	192,4	44	775
VF 320/90 R42 163D TL SPRAYBIB	920383	44635	438	17,2	1634,5	64,4	4890	192,5	44	800
VF 650/60 R34 168D/165E TL AXIOBIB 2	202185		831	32,7	1653	65,1	4895	192,7		775

GRÁFICO DE CIRCUNFERENCIA DEL RODAMIENTO

MEDIDA Y MODELO DEL NEUMÁTICO	CAI	MSPN	Mínimo espacio doble		Diámetro del neumático		Circunferencia del rodamiento		RCI	SRI
			mm	Pol.	mm	Pol.	mm	Pol.		
600/65 R34 151D TL MULTIBIB	557189	16291	760	29,9	1654	65,1	4897	192,8	44	775
1000/50 R25 172A8/166D TL MEGAXBIB 2	852423	76362	1306	51,4	1654	65,1	4907	193,2		750
320/90 R42 147A8/147B TL AGRIBIB RC	425361	64720	434	17,1	1638	64,5	4908	193,2	44	800
VF 620/75 R30 172D/169E TL AXIOBIB 2	702894	20861	814	32,0	1670	65,7	4919	193,7	44	800
IF 620/75 R30 164D TL AXIOBIB	668406	96772	814	32,0	1670	65,7	4927	194,0	44	800
IF 650/60 R34 165D TL AXIOBIB	100511	94599	807	31,8	1661	65,4	4933	194,2		775
750/60 R30.5 181D TL CARGOXBIB	054202	83575	956	37,6	1680	66,1	4936	194,3		800
750/60 R30.5 181D TL CARGOXBIB HIGH FLOTATION	101332	77049	956	37,6	1675	65,9	4936	194,3		800
18.4 R34 149A8/146B TL AGRIBIB	679786	71754	611	24,1	1662	65,4	4940	194,5	44	775
650/60 R34 159D/155E TL MACHXBIB	549996		837	33,0	1664	65,5	4950	194,9		775
VF 710/65 R30 CFO+ 179A8 TL CEREXBIB2	608814	22560	876	34,5	1676	66,0	4952	195,0		800
VF 500/85 R34 CFO+ 172A8 TL CEREXBIB2	038009	29877	642	25,3	1676	66,0	4961	195,3		825
540/65 R38 147D TL MULTIBIB	114518	28857	687	27,0	1675	65,9	4965	195,5	44	800
420/85 R38 144A8/144B TL AGRIBIB	607820	84239	576	22,7	1676	66,0	4975	195,9	44	800
VF 600/60 R38 151D TL XEOBIB	349257	80626	755	29,7	1698	66,9	5023	197,8	44	800
IF 710/60 R34 164D TL AXIOBIB	712503	67777	900	35,4	1696	66,8	5030	198,0		825
480/70 R38 145D TL OMNIBIB	936570	28503	626	24,6	1694	66,7	5030	198,0	44	800
VF 650/65 R34 167D TL EVOBIB	262107	73467	831	32,7	1707	67,2	5032	198,1		825
380/95 R38 147A8/147B TL AGRIBIB	836033	65207	507	20,0	1689	66,5	5034	198,2		800
420/85 R38 149A8/149B TL AGRIBIB 2	048439		576	22,7	1690	66,5	5035	198,2	44	800
VF 380/95 R38 154A8/154B TL YIELDBIB	873023	47225	510	20,1	1703	67,0	5044	198,6	44	800
VF 650/65 R34 170D/167E TL AXIOBIB 2	101906	79000	831	32,7	1710	67,3	5061	199,3		825
IF 650/75 R30 166D TL AXIOBIB	828322	96826	838	33,0	1721	67,8	5071	199,6	45	825
620/75 R30 168A8/168B TL MEGAXBIB	753673	63928	801	31,5	1710	67,3	5083	200,1	44	800
IF 650/65 R34 161D TL AXIOBIB	711975	26241	831	32,7	1721	67,8	5099	200,7		825
VF 650/60 R38 155D TL XEOBIB	454365	80851	831	32,7	1735	68,3	5108	201,1	45	825
650/65 R34 161D/157E TL MACHXBIB	817386		837	33,0	1723	67,8	5125	201,8		825
VF 650/60 R38 170D/167E TL AXIOBIB 2	908973		831	32,7	1742	68,6	5145	202,6	45	825
340/85 R46 150A8/150B TL AGRIBIB RC	846786	94547	462	18,2	1747	68,8	5227	205,8	45	825
600/65 R38 153D TL MULTIBIB	228045	29767	760	29,9	1768	69,6	5229	205,9	45	825
520/70 R38 150D TL OMNIBIB	833744	28089	670	26,4	1766	69,5	5229	205,9	45	825
18.4 R38 151A8/148B TL AGRIBIB	100097	63603	611	24,1	1770	69,7	5267	207,4	45	825
480/80 R38 166A8/161D IND TL CROSSGRIP	846732		626	24,6	1757	69,2	5293	208,4		825
800/60 R32 185D IMP TL CARGOXBIB HIGH FLOTATION	322432		1032	40,6	1800	70,9	5300	208,7		875
VF 710/60 R38 160D TL XEOBIB	324138	81759	900	35,4	1814	71,4	5356	210,9	46	875
650/65 R38 157D TL MULTIBIB	292904	12871	825	32,5	1819	71,6	5380	211,8	46	875
620/75 R34 170A8/170B TL MEGAXBIB	325025	83734	801	31,5	1814	71,4	5398	212,5		825

GRÁFICO DE CIRCUNFERENCIA DEL RODAMIENTO

MEDIDA Y MODELO DEL NEUMÁTICO	CAI	MSPN	Mínimo espacio doble		Diámetro del neumático		Circunferencia del rodamiento		RCI	SRI
			mm	Pol.	mm	Pol.	mm	Pol.		
650/75 R32 172A8/172B TL MEGAXBIB 2	642277		837	33,0	1837	72,3	5422	213,5	45	875
650/75 R32 172A8/172B TL MEGAXBIB	468227	46686	837	33,0	1825	71,9	5423	213,5	45	875
580/70 R38 155D TL OMNIBIB	001240	31198	743	29,3	1836	72,3	5440	214,2	46	875
VF 650/60 R42 157D TL XEOBIB	220583	10918	831	32,7	1840	72,4	5441	214,2	46	875
IF 650/65 R38 169D TL AXIOBIB	508421	87017	831	32,7	1826	71,9	5446	214,4		875
800/65 R32 178A8/178B TL MEGAXBIB	521809	49342	1032	40,6	1840	72,4	5459	214,9	46	875
480/80 R42 156A8/156B TL AGRIBIB 2	539386	05745	638	25,1	1840	72,4	5470	215,4	46	875
800/65 R32 178A8/178B TL MEGAXBIB 2	135425		1032	40,6	1839	72,4	5471	215,4	46	875
VF 480/80 R42 176D TL SPRAYBIB	929553	13814	626	24,6	1838	72,4	5471	215,4	46	875
IF 710/60 R38 172D TL AXIOBIB	220975	69189	900	35,4	1844	72,6	5486	216,0		875
IF 800/65 R32 CFO 178A8 TL CEREXBIB	651074	39571	994	39,1	1855	73,0	5493	216,3	46	875
520/85 R38 160A8/160B TL AGRIBIB 2	882358	05183	670	26,4	1849	72,8	5493	216,3	46	875
IF 800/65 R32 CFO+ 181A8 TL CEREXBIB2	987406	25367	994	39,1	1855	73,0	5501	216,6	46	875
20.8 R38 159A8/156B TL AGRIBIB	813266	17548	684	26,9	1850	72,8	5506	216,8	46	875
1050/50 R32 184A8/184B TL MEGAXBIB T2	829536	28613	1346	53,0	1856	73,1	5510	216,9	46	875
680/75 R32 164A8/161B TL XM28	123582	80305	862	33,9	1865	73,4	5512	217,0	46	875
420/80 R46 151A8/151B TL AGRIBIB 2	885138		552	21,7	1854	73,0	5524	217,5	46	925
520/85 R38 155A8/155B TL AGRIBIB	303668	43308	670	26,4	1855	73,0	5529	217,7	46	875
VF 380/90 R46 173D TL SPRAYBIB	198604	27358	510	20,1	1842	72,5	5530	217,7	46	925
VF 320/90 R50 166D TL SPRAYBIB	946508		438	17,2	1844	72,6	5531	217,8	46	925
1050/50 R32 178A8/172D TL MEGAXBIB 2	424273	12011	1346	53,0	1866	73,5	5537	218,0	46	875
480/80 R42 156A8/156B TL AGRIBIB	404096	03395	638	25,1	1858	73,1	5538	218,0	46	875
320/90 R50 150A8/150B TL AGRIBIB RC	130813	95098	434	17,1	1847	72,7	5539	218,1	46	925
IF 1000/55 R32 CFO 191D/188E TL FLOATXBIB	564739		1258	49,5	1877	73,9	5540	218,1		925
420/80 R46 151A8/148B TL AGRIBIB	122770	58733	552	21,7	1872	73,7	5555	218,7	46	925
620/70 R38 170A8/170B TL MEGAXBIB	476088	99512	801	31,5	1864	73,4	5557	218,8	46	875
VF 710/60 R42 176D/173E TL AXIOBIB 2	941770	78256	900	35,4	1885,3	74,2	5574	219,4	47	925
380/90 R46 157A8/157B TL AGRIBIB RC	799905	38865	519	20,4	1864	73,4	5583	219,8	46	925
VF 900/60 R32 CFO+ 191A8 TL CEREXBIB 2	430737	73624	1108	43,6	1903	74,9	5618	221,2		925
900/60 R32 181A8/181B TL MEGAXBIB	824122	40581	1114	43,9	1894	74,6	5626	221,5	46	925
900/60 R32 181A8/181B TL MEGAXBIB 2	166896		1114	43,9	1899	74,8	5635	221,9	46	925
710/75 R34 178A8/178B TL MEGAXBIB	543107	13589	910	35,8	1900	74,8	5637	221,9	47	925
IF 900/60 R32 CFO 185A8 TL CEREXBIB	752825	03456	1071	42,2	1906	75,0	5643	222,2		925
1050/50 R32 178A8 TL MEGAXBIB M28	236234	94737	1346	53,0	1902	74,9	5649	222,4	46	875
VF 710/60 R42 161D TL XEOBIB	144294	94391	900	35,4	1920	75,6	5675	223,4	47	925
VF 650/65 R42 174D/171E TL AXIOBIB 2	387916	43835	831	32,7	1920	75,6	5680	223,6	47	925
IF 680/85 R32 CFO 179A8 TL CEREXBIB	932041	18128	869	34,2	1935	76,2	5711	224,8	47	925

GRÁFICO DE CIRCUNFERENCIA DEL RODAMIENTO

MEDIDA Y MODELO DEL NEUMÁTICO	CAI	MSPN	Mínimo espacio doble		Diámetro del neumático		Circunferencia del rodamiento		RCI	SRI
			mm	Pol.	mm	Pol.	mm	Pol.		
650/65 R42 158D TL MULTIBIB	167733		825	32,5	1931	76,0	5722	225,3	47	925
800/70 R32 181A8/181B TL MEGAXBIB	695992	68880	1032	40,6	1936	76,2	5725	225,4		925
VF 480/80 R46 164A8/164B TL YIELDIBIB	842300	10807	626	24,6	1933	76,1	5732	225,7	47	925
IF 1000/55 R32 CFO 188A8 TL CEREXBIB	131720	22858	1258	49,5	1931	76,0	5758	226,7		925
650/75 R38 169A8/169B TL MACHXBIB	219467	86829	861	33,9	1948	76,7	5761	226,8	47	925
520/85 R42 157A8/157B TL AGRIBIB	122791	63687	694	27,3	1945	76,6	5771	227,2	47	925
620/70 R42 160D TL OMNIBIB	989457	31015	801	31,5	1953	76,9	5781	227,6	47	925
520/85 R42 162A8/162B TL MEGAXBIB	645194	15488	694	27,3	1937	76,3	5783	227,7	47	925
IF 800/70 R32 CFO 182A8 TL CEREXBIB	525718	18258	1004	39,5	1958	77,1	5788	227,9		925
VF 480/80 R46 177D TL SPRAYBIB	159186	21151	626	24,6	1943	76,5	5790	228,0	47	925
IF 800/70 R32 CFO+ 185A8 TL CEREXBIB2	789156	71535	1004	39,5	1950	76,8	5800	228,3		925
480/80 R46 158A8/158B TL AGRIBIB 2	622709	00639	638	25,1	1945	76,6	5804	228,5	47	925
710/70 R38 171D TL MACHXBIB	708197	30751	910	35,8	1973	77,7	5804	228,5	47	925
VF 520/85 R42 CFO+ 177A8 TL CEREXBIB 2	270459	15337	682	26,9	1953	76,9	5807	228,6	47	925
VF 520/85 R42 CFO 177A8 TL CEREXBIB	934265	78620	682	26,9	1953	76,9	5807	228,6	47	925
520/85 R42 162A8/162B TL AGRIBIB 2	405859	13435	694	27,3	1958	77,1	5810	228,7	47	925
380/90 R50 151A8/151B TL AGRIBIB RC	036849	15852	519	20,4	1935	76,2	5813	228,9	47	975
900/50 R42 168A8/168B TL MACHXBIB	122703	71498	1114	43,9	1947	76,7	5815	228,9	47	975
IF 680/75 R38 CFO 180A8 TL CEREXBIB	833220	02720	806	31,7	1965	77,4	5823	229,3		975
900/50 R42 168D TL MACHXBIB	832458	03779	1114	43,9	1970	77,6	5826	229,4	47	975
VF 380/90 R50 175D TL SPRAYBIB	722276	28608	510	20,1	1951	76,8	5836	229,8	47	975
VF 320/90 R54 168D TL SPRAYBIB	044008		438	17,2	1950	76,8	5851	230,4		975
320/90 R54 151A8/151B TL AGRIBIB RC	272304	96185	434	17,1	1950	76,8	5852	230,4	47	975
620/70 R42 166A8/166B TL MEGAXBIB	100268	15145	801	31,5	1961	77,2	5857	230,6	47	925
480/80 R46 158A8/158B TL AGRIBIB	637231	94069	638	25,1	1948	76,7	5874	231,3	47	925
VF 900/60 R38 CFO+ 193A8 TL CEREXBIB 2	439024	31193	1108	43,6	2029	79,9	5993	235,9		975
VF 710/70 R42 179D TL EVOBIB	363574	21253	910	35,8	2042	80,4	6003	236,3		975
IF 900/60 R38 CFO 184A8 TL CEREXBIB	296920	14429	1108	43,6	2033	80,0	6017	236,9	48	975
IF 900/60 R38 CFO 188A8 TL CEREXBIB MI	853436	03936	1108	43,6	2029	79,9	6017	236,9	48	975
710/70 R42 173D/170E TL ROADBIB	885975	27650	910	35,8	2028	79,8	6025	237,2	48	975
IF 680/80 R38 CFO+ 182A8 TL CEREXBIB2	953912	20691	845	33,3	2020	79,5	6030	237,4		975
VF 480/80 R50 166A8/166B TL YIELDIBIB	309830	02098	614	24,2	2039	80,3	6034	237,6	48	975
VF 580/85 R42 CFO+ 183A8 TL CEREXBIB2	844076	45547	754	29,7	2040	80,3	6040	237,8		975
580/85 R42 168A8/168B TL MEGAXBIB	241561	39595	743	29,3	2043	80,4	6072	239,1	48	975
IF 800/70 R38 CFO 184A8 TL CEREXBIB	646846	39234	1004	39,5	2048	80,6	6072	239,1	48	975
IF 650/85 R38 179D TL AXIOBIB	084900	97250	845	33,3	2050	80,7	6078	239,3	48	975
VF 650/85 R38 182D/179E TL AXIOBIB 2	655949		845	33,3	2063	81,2	6078	239,3		975

GRÁFICO DE CIRCUNFERENCIA DEL RODAMIENTO

MEDIDA Y MODELO DEL NEUMÁTICO	CAI	MSPN	Mínimo espacio doble		Diámetro del neumático		Circunferencia del rodamiento		RCI	SRI
			mm	Pol.	mm	Pol.	mm	Pol.		
IF 800/70 R38 CFO 187A8 TL CEREXBIB MI	445898	24897	1004	39,5	2051	80,7	6079	239,3	48	975
IF 800/70 R38 CFO+ 187A8 TL CEREXBIB2	610997	25474	1004	39,5	2051	80,7	6079	239,3	48	975
VF 800/70 R38 187D/184E TL AXIOBIB 2	136377		1004	39,5	2072	81,6	6086	239,6		975
520/85 R46 158A8/155B TL AGRIBIB	122780	57479	670	26,4	2050	80,7	6088	239,7	48	975
IF 800/70 R38 179D TL AXIOBIB	528166	99142	1004	39,5	2067	81,4	6089	239,7	48	975
710/70 R42 173A8/173B TL MACHXBIB	849847	36718	910	35,8	2050	80,7	6089	239,7	48	975
650/85 R38 173A8/173B TL MACHXBIB	118628	89462	861	33,9	2063	81,2	6092	239,8	48	975
800/70 R 38 173D TL MACHXBIB	887730	29390	1008	39,7	2066	81,3	6093	239,9	48	975
650/85 R38 173A8/173B TL MEGAXBIB	173491	19212	861	33,9	2048	80,6	6100	240,2	48	975
VF 480/80 R50 179D TL SPRAYBIB	431251	50045	626	24,6	2045	80,5	6101	240,2	48	975
VF 710/70 R42 182D/179E TL AXIOBIB 2	523668		910	35,8	2066	81,3	6104	240,3		975
520/85 R46 164A8/164B TL AGRIBIB 2	120922	17697	658	25,9	2059	81,1	6110	240,6	48	975
800/70 R38 173A8/173B TL MACHXBIB	296457	72379	1008	39,7	2073	81,6	6114	240,7	48	975
IF 710/70 R42 179D TL AXIOBIB	771752	99783	910	35,8	2062	81,2	6115	240,7	48	975
480/80 R50 159A8/159B TL AGRIBIB 2	263049	41183	626	24,6	2050	80,7	6116	240,8	48	975
VF 420/95 R50 177D TL SPRAYBIB	085405	82545	554	21,8	2052	80,8	6118	240,9	48	1025
620/70 R46 162A8/162B TL XM28	122723	69879	801	31,5	2061	81,1	6122	241,0	48	975
380/90 R54 152A8/152B TL AGRIBIB 2	075615	28485	507	20,0	2054	80,9	6129	241,3	48	1025
VF 380/90 R54 176D TL SPRAYBIB	816598	47923	510	20,1	2049	80,7	6131	241,4	48	1025
480/80 R50 159A8/159B TL AGRIBIB	471947	94576	626	24,6	2056	80,9	6135	241,5	48	975
710/70 R42 173D TL MACHXBIB	790388	31962	910	35,8	2088	82,2	6195	243,9	48	975
VF 710/70 R42 CFO+ 188A8 TL CEREXBIB 2	499992	60118	886	34,9	2097	82,6	6207	244,4		975
IF 710/70 R42 CFO 182A8 TL CEREXBIB	003912	61530	886	34,9	2097	82,6	6230	245,3	48	975
VF 710/75 R42 181D TL EVOBIB	149217	78454	910	35,8	2133	84,0	6277	247,1	49	1025
VF 900/60 R42 CFO+ 195A8 TL CEREXBIB2	856296	03717	1108	43,6	2118	83,4	6281	247,3		1025
IF 900/60 R42 186D TL AXIOBIB	111950	82481	1108	43,6	2123	83,6	6304	248,2	49	1025
VF 710/75 R42 184D/180E TL AXIOBIB 2	259635		910	35,8	2153	84,8	6320	248,8	49	1025
IF 710/85 R38 178D TL AXIOBIB	992951	99013	918	36,1	2159	85,0	6365	250,6	49	1025
IF 800/70 R42 CFO+ 189A8 TL CEREXBIB2	818789	91180	1004	39,5	2151	84,7	6387	251,5		1025
VF 650/85 R42 183D/180E TL AXIOBIB 2	530764	06000	845	33,3	2164	85,2	6393	251,7	49	1025
IF 710/75 R42 176D TL AXIOBIB	037489	25479	910	35,8	2161	85,1	6395	251,8	49	1025
710/75 R42 175D/171E TL MACHXBIB	015540		910	35,8	2158	85,0	6424	252,9	49	1025
VF 750/70 R44 186D/183E TL AXIOBIB 2	681569		941	37,0	2180	85,8	6438	253,5		1025
480/95 R50 164A8/164B TL AGRIBIB	491183	54736	638	25,1	2175	85,6	6484	255,3		1075
VF 480/95 R50 170A8/170B TL YIELDBIB	252129	65206	614	24,2	2186	86,1	6661	262,2	49	1075
IF 750/75 R46 186D TL AXIOBIB	487001	07217	941	37,0	2287	90,0	6819	268,5	50	1125
IF 900/65 R46 190D TL AXIOBIB	162365	36973	1108	43,6	2322	91,4	6888	271,2	50	1125

ÍNDICE DE CARGA

ÍNDICE DE CARGA	KG	LBS	ÍNDICE DE CARGA	KG	LBS	ÍNDICE DE CARGA	KG	LBS
100	800	1764	133	2060	4542	166	5300	11684
101	825	1819	134	2120	4674	167	5450	12015
102	850	1874	135	2180	4806	168	5600	12346
103	875	1929	136	2240	4938	169	5800	12787
104	900	1984	137	2300	5071	173	6000	13228
105	925	2039	138	2360	5203	171	6150	13558
106	950	2094	139	2430	5357	172	6300	13889
107	975	2150	140	2500	5512	173	6500	14330
108	1000	2205	141	2575	5677	174	6700	14771
109	1030	2271	142	2650	5842	175	6900	15212
110	1060	2337	143	5725	12621	176	7100	15653
111	1090	2403	144	2800	6173	177	7300	16094
112	1120	2469	145	2900	6393	178	7500	16535
113	1150	2535	146	3000	6614	179	7750	17086
114	1180	2601	147	3075	6779	180	8000	17637
115	1215	2679	148	3150	6945	181	8250	18188
116	1250	2756	149	3250	7165	182	8500	18739
117	1285	2833	150	3350	7385	183	8750	19290
118	1320	2910	151	3450	7606	184	9000	19842
119	1360	2998	152	3550	7826	185	9250	20393
120	1400	3086	153	3650	8047	186	9500	20944
121	1450	3197	154	3750	8267	187	9750	21495
122	1500	3307	155	3875	8543	188	10000	22046
123	1550	3417	156	4000	8818	189	10300	22708
124	1600	3527	157	4125	9094	190	10600	23369
125	1650	3638	158	4250	9370	191	10900	24030
126	1700	3748	159	4375	9645	192	11200	24692
127	1750	3858	160	4500	9921	193	11500	25353
128	1800	3968	161	4625	10196	194	11800	26015
129	1850	4079	162	4750	10472	195	12150	26786
130	1900	4189	163	4875	10748	196	12500	27558
131	1950	4299	164	5000	11023	197	12850	28329
132	200	441	165	5150	11354	198	13200	29101

NUEVA CARGA/PRESIÓN

■ NUEVAS TABLAS DE CARGA/PRESIÓN A 10 Y 30 KM/H PARA NEUMÁTICOS DE TRACTOR CON TECNOLOGÍA MICHELIN® ULTRAFLEX (MUT)

¡MICHELIN® siempre ha invertido para que sus clientes puedan beneficiarse de las últimas revoluciones tecnológicas!

El avance de la inflación a cierta distancia del mercado agrícola exigió cambios en los patrones de Mejor Flexión – Improved Flexion (IF) y Muy Alta Flexión: Very High Flexion (VF), algo que se logró en febrero de 2019 (ETRT0).



Las nuevas curvas de carga/presión a 10 y 30 km/h para neumáticos con tecnología MICHELIN® Ultraflex para tractores, ayudan a adaptar la presión de los neumáticos al uso y aplicación previstos. Combinados con un sistema de inflado a distancia que optimiza estas variaciones en tiempo real, los neumáticos MICHELIN® ULTRAFLEX ahora pueden ofrecer su mejor desempeño.

- Baja presión en el campo: el suelo está protegido y la productividad optimizada.
- Mayores presiones en la carretera: mayor velocidad con control del consumo de combustible y seguridad, así como el confort de conducción.



■ PRUEBA EN NÚMEROS

(Ejemplo de un cálculo basado en MACHXBIB (estándar), AXIOBIB (IF) y AXIOBIB 2 (VF) - Tamaño 710/70 R42)

POSIBLE CAÍDA DE PRESIÓN CON UNA CARGA DE 5,500 KG

(bar)	10 km/h	30 km/h	65 km/h
Estándar	1	1.3	1.6
IF	 1	 1.1	 1.2
VF	0.8	0.9	1

POSIBLE AUMENTO DE CARGA CON UNA PRESIÓN DE 1.2 BAR

(kg)	10 km/h	30 km/h	65 km/h
Estándar	6200	5200	4500
IF	 6200	 5700	 5500
VF	7000	6400	6300

TECNOLOGÍAS MICHELIN® ULTRAFLEX



■ MAYOR PROTECCIÓN DEL SUELO

Las tecnologías MICHELIN® Ultraflex producen una área de contacto con el suelo más grande que protege el suelo de la compactación y los surcos. El aire y el agua penetran más libremente. Mejorando las condiciones para una máxima respuesta del cultivo.

■ MÁS ECONOMÍA DE COMBUSTIBLE

El área de contacto con el suelo más grande aumenta considerablemente la tracción, lo que resulta en una clara reducción del patinaje de las ruedas del tractor, permitiéndole trabajar más rápido y ahorrar combustible.

■ MAYOR RESISTENCIA Y VIDA ÚTIL

Las paredes laterales reforzadas y los compuestos especiales de caucho hacen que los neumáticos agrícolas MICHELIN® con Tecnología Ultraflex sean extremadamente resistentes, incluso a bajas presiones.

Sección transversal del neumático

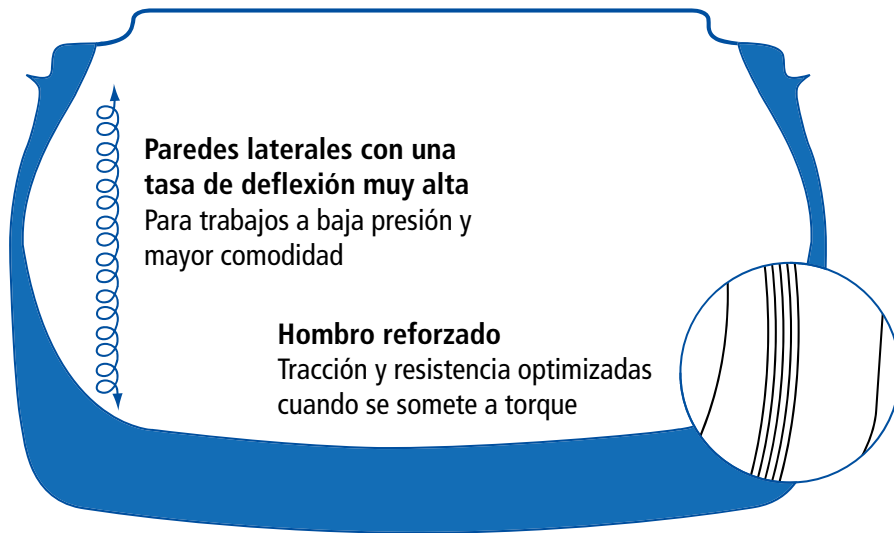

Paredes laterales con una tasa de deflexión muy alta
Para trabajos a baja presión y mayor comodidad

Hombro reforzado
Tracción y resistencia optimizadas cuando se somete a torque

Corona plana

Huella extendida para proteger el suelo y proporcionar la máxima tracción

LISTA DE NEUMÁTICOS DESCATALOGADOS

Este DATABOOK técnico se realiza únicamente con fines informativos.

Este no es un documento comercial.

Consulte a su representante de ventas local de MICHELIN® para verificar la disponibilidad de los neumáticos.

CAI	MODELO	MEDIDA
836509	AGRIBIB	380/85R30 135A8/135B TL
953332	AGRIBIB	420/90R30 147A8/147B TL
122760	AGRIBIB	320/85R34 133A8/130B TL
122781	AGRIBIB	380/85R34 137A8/137B TL
788910	AGRIBIB	420/85R34 147A8/147B TL
607820	AGRIBIB	420/85R38 144A8/144B TL
303668	AGRIBIB	520/85R38 155A8/155B TL
404096	AGRIBIB	480/80R42 156A8/156B TL
122791	AGRIBIB	520/85R42 157A8/157B TL
122770	AGRIBIB	420/80R46 151A8/148B TL
637231	AGRIBIB	480/80R46 158A8/158B TL
122780	AGRIBIB	520/85R46 158A8/155B TL
471947	AGRIBIB	480/80R50 159A8/159B TL
550621	CARGOXBIB HIGH FLOTATION	600/55R26.5 165D TL
892516	CARGOXBIB HIGH FLOTATION	710/50R26.5 170D TL
693431	CARGOXBIB HIGH FLOTATION	650/55R26.5 169D TL
101332	CARGOXBIB HIGH FLOTATION	750/60R30.5 181D TL
972024	CEREXBIB	VF 520/80R26 CFO 168A8 TL
656967	CEREXBIB	VF 620/70R26 CFO 173A8 TL
811382	CEREXBIB	VF 750/65R26 CFO 177A8 TL
886789	CEREXBIB	VF 620/70R30 CFO 172A8 TL
795916	CEREXBIB	VF 520/85R30 CFO 172A8 TL
651074	CEREXBIB	IF 800/65R32 CFO 178A8/178B TL
752825	CEREXBIB	IF 900/60R32 CFO 185A8 TL
525718	CEREXBIB	IF 800/70R32 CFO 182A8/182B TL
853436	CEREXBIB	IF 900/60R38 CFO 188A8 TL
296920	CEREXBIB	IF 900/60R38 CFO 184A8 TL
646846	CEREXBIB	IF 800/70R38 CFO 184A8/184B TL
445898	CEREXBIB	IF 800/70R38 CFO 187A8 TL
934265	CEREXBIB	VF 520/85R42 CFO 177A8 TL
003912	CEREXBIB	IF 710/70R42 CFO 182A8 TL
478428	MEGAXBIB	750/50R26 160A8/154D TL
521809	MEGAXBIB	800/65R32 178A8/178B TL
824122	MEGAXBIB	900/60R32 181A8/181B TL
122712	X M108	420/65R24 126A8/126B TL
123582	X M28	680/75R32 164A8/161B TL



MICHELIN® EVOBIB

LA TECNOLOGÍA DE DISEÑO ADAPTABLE 2 EN 1



Para tractores de alta potencia > 200 HP.
Funciona mejor con el sistema central de inflado de neumáticos (CTIS, por sus siglas en inglés)



Tecnología de neumáticos «2 en 1»
Diseño adaptable en la carretera o en el campo
VF Very High Flexion



Productividad

- Durabilidad
- Ahorro de combustible
- 30% más tracción⁽¹⁾



Respeto de los suelos

- 20% más de longitud de huella⁽¹⁾
- Baja presión en los campos



Estabilidad a altas velocidades⁽²⁾

Banda central continua

(1) Estudio interno: Francia Ladoux, neumático MICHELIN® EVOBIB VF 710/70R42 frente al neumático AXIOBIB IF 710/70R42 a 0.8b.

(2) Dentro de los límites estipulados en la legislación vigente del país.

DIMENSIONES

VF 600/70 R30 165D TL **NUEVO**

VF 650/65 R34 167D TL **NUEVO**

VF 710/70 R42 179D TL **NUEVO**

VF 710/75 R42 181D TL **NUEVO**

MICHELIN® EVOBIB

Características y presiones en (Bar) y (Psi): carga por neumático en kg*

Ø Pulgadas	Descripción	CAI	S mm	D mm	R' mm	Cdr. mm	Llanta recomendada	Llanta permitida	Cámara de aire (Código)	Volumen interno al 75% (litros)	Profundidad de la banda de rodamiento (mm)	
30	VF 600/70 R30 165D TL NUEVO	266793	608	1574	668	4616	DW21B (A)	DW20B (A)	737	468	51	
Bar	1.8(R) 1.8(R) 1.8(R) 1.8(R) 1.8(R) 1.8(R) 1.8(R) 1.8(R) 1.8(R) 1.8(R) 1.8(R) 1.8(R)											
	0.4(C) 0.5(C) 0.6(C) 0.7(C) 0.8(C) 0.9(C) 1.0(C) 1.1(C) 1.2(C) 1.3(C) 1.4(C) 1.5(C) 1.6(C)											
Psi	26(R) 26(R) 26(R) 26(R) 26(R) 26(R) 26(R) 26(R) 26(R) 26(R) 26(R) 28(R) 29(R)											
	6(C) 7(C) 9(C) 10(C) 12(C) 13(C) 15(C) 16(C) 17(C) 19(C) 20(C) 22(C) 23(C)											
65 km/h		2800	3025	3250	3500	3750	4000	4250	4475	4700	4925	5150
65 km/h Dual	2075 2275 2470	2665	2860	3080	3300	3520	3740	3940	4135	4335	4530	

Ø Pulgadas	Descripción	CAI	S mm	D mm	R' mm	Cdr. mm	Llanta recomendada	Llanta permitida	Cámara de aire (Código)	Volumen interno al 75% (litros)	Profundidad de la banda de rodamiento (mm)	
34	VF 650/65 R34 167D TL NUEVO	262107	638	1707	741	5032	DW23B (A)			555	51	
Bar	1.8(R) 1.8(R) 1.8(R) 1.8(R) 1.8(R) 1.8(R) 1.8(R) 1.8(R) 1.8(R) 1.8(R) 1.8(R) 1.8(R)											
	0.4(C) 0.5(C) 0.6(C) 0.7(C) 0.8(C) 0.9(C) 1.0(C) 1.1(C) 1.2(C) 1.3(C) 1.4(C) 1.5(C) 1.6(C)											
Psi	26(R) 26(R) 26(R) 26(R) 26(R) 26(R) 26(R) 26(R) 26(R) 26(R) 26(R) 28(R) 29(R)											
	6(C) 7(C) 9(C) 10(C) 12(C) 13(C) 15(C) 16(C) 17(C) 19(C) 20(C) 22(C) 23(C)											
65 km/h		3075	3315	3550	3820	4090	4355	4625	4830	5040	5245	5450
65 km/h Dual	2265 2480 2695	2910	3125	3360	3600	3835	4070	4250	4435	4615	4795	

Ø Pulgadas	Descripción	CAI	S mm	D mm	R' mm	Cdr. mm	Llanta recomendada	Llanta permitida	Cámara de aire (Código)	Volumen interno al 75% (litros)	Profundidad de la banda de rodamiento (mm)	
42	VF 710/70 R42 179D TL NUEVO	363574	725	2042	875	6003	DW25B (A)	DW23B (A) MW25B (A)	802	867	54	
Bar	1.8(R) 1.8(R) 1.8(R) 1.8(R) 1.8(R) 1.8(R) 1.8(R) 1.8(R) 1.8(R) 1.8(R) 1.8(R) 1.8(R)											
	0.4(C) 0.5(C) 0.6(C) 0.7(C) 0.8(C) 0.9(C) 1.0(C) 1.1(C) 1.2(C) 1.3(C) 1.4(C) 1.5(C) 1.6(C)											
Psi	26(R) 26(R) 26(R) 26(R) 26(R) 26(R) 26(R) 26(R) 26(R) 26(R) 26(R) 28(R) 29(R)											
	6(C) 7(C) 9(C) 10(C) 12(C) 13(C) 15(C) 16(C) 17(C) 19(C) 20(C) 22(C) 23(C)											
65 km/h		4250	4625	5000	5325	5650	5975	6300	6665	7025	7390	7750
65 km/h Dual	3125 3445 3760	4080	4400	4685	4970	5260	5545	5865	6180	6500	6820	

Ø Pulgadas	Descripción	CAI	S mm	D mm	R' mm	Cdr. mm	Llanta recomendada	Llanta permitida	Cámara de aire (Código)	Volumen interno al 75% (litros)	Profundidad de la banda de rodamiento (mm)	
42	VF 710/75 R42 181D TL NUEVO	149217	717	2133	919	6277	DW25B (A)			952	56	
Bar	1.8(R) 1.8(R) 1.8(R) 1.8(R) 1.8(R) 1.8(R) 1.8(R) 1.8(R) 1.8(R) 1.8(R) 1.8(R) 1.8(R)											
	0.4(C) 0.5(C) 0.6(C) 0.7(C) 0.8(C) 0.9(C) 1.0(C) 1.1(C) 1.2(C) 1.3(C) 1.4(C) 1.5(C) 1.6(C)											
Psi	26(R) 26(R) 26(R) 26(R) 26(R) 26(R) 26(R) 26(R) 26(R) 26(R) 26(R) 28(R) 29(R)											
	6(C) 7(C) 9(C) 10(C) 12(C) 13(C) 15(C) 16(C) 17(C) 19(C) 20(C) 22(C) 23(C)											
65 km/h		4500	4900	5300	5650	6000	6350	6700	7090	7475	7865	8250
65 km/h Dual	3300 3640 3985	4325	4665	4975	5280	5590	5895	6235	6580	6920	7260	

***IMPORTANTE:**

La presión de inflado se determina siempre en función de la carga por neumático, de la velocidad y del trabajo a realizar. Las recomendaciones anteriores se facilitan con la salvedad de modificaciones posteriores a la fecha de difusión de estas tablas (junio de 2018). Los datos técnicos pueden sufrir modificaciones sin previo aviso.

- Cuando se usa la configuración de montaje único (single):
 - Añadir 0.4 Bar para usar en pendientes superiores al 20%
 - Añadir 0.4 Bar para uso pesado en carreteras superiores al 50%
- (R) Presión en la carretera
- (C) Presión en el campo



NUEVO

MICHELIN® ROADBIB

**LA SOLUCIÓN PARA USO
EN CARRETERAS PESADAS**



AHORRO DE COMBUSTIBLE

- Una amplia área de contacto con el suelo combinada con una escultura poco profunda proporciona baja resistencia al rodamiento y, por lo tanto, menor consumo de combustible



LARGA VIDA

- Excelente rendimiento en términos de longevidad: + 20% más de goma en el piso vs. MachXBib
- Diseño exclusivo: nueva banda de rodamiento
- Neumáticos direccionales



COMODIDAD EXCEPCIONAL

- La escultura central lisa mejora el confort en las carreteras
- El espacio reducido entre bloques (en comparación con las esculturas tradicionales) limita las vibraciones de la cabina
- Minimización del impacto acústico del neumático: fuera y dentro de la cabina



MANEJO Y SEGURIDAD

- Mejor calidad de conducción gracias a una nueva escultura de neumático semejante a la de un camión
- Buen agarre de los neumáticos en carreteras mojadas gracias a la escultura de evacuación vertical



DIMENSIONES

540/65 R30 150D/146E TL **NUEVO**

600/70 R30 158D/155E TL

650/60R34 159D/155E TL **NUEVO**

650/65R34 161D/157E TL **NUEVO**

650/65R42 165D/161E TL **NUEVO**

710/70 R42 173D/170E TL

710/75R42 175D/171E TL **NUEVO**

MICHELIN® ROADBIB

Características y presiones en (Bar) y (Psi): carga por neumático en kg*

Ø Pulgadas	Descripción	CAI	S mm	D mm	R' mm	Cdr. mm	Llanta recomendada	Llanta permitida	Cámara de aire (Código)	Volumen interno al 75% (litros)	Profundidad de la banda de rodamiento (mm)		
30	540/65R30 150D/146E TL NUEVO	274757	547	1464	679	4382	DW16L	W18L	754	332	32.5		
Bar	0.4	0.6	0.8	1	1.2	1.4	1.6	1.8	2	2.2	2.4	2.6	2.8
Psi	6	9	12	15	17	20	23	26	29	32	35	38	41
10 km/h**	1930	2185	2445	2700	3000	3300	3600	3900	4200	4405	4615	4820	5025
30 km/h	1480	1755	2030	2310	2585	2860	3135	3315	3495	3675	3855		
40 km/h		1695	1955	2210	2470	2725	2985	3155	3330	3500	3670		
50 km/h		1630	1875	2120	2370	2615	2860	3025	3190	3355	3520		
65 km/h			1800	2030	2265	2495	2725	2880	3040	3195	3350		
70 km/h			1640	1850	2060	2270	2480	2610	2740	2870	3000		

Ø Pulgadas	Descripción	CAI	S mm	D mm	R' mm	Cdr. mm	Llanta recomendada	Llanta permitida	Cámara de aire (Código)	Volumen interno al 75% (litros)	Profundidad de la banda de rodamiento (mm)		
30	600/70 R30 158D/155E TL	217911	604	1569	706	4663	DW20B (A)	DW18L DW21B (A)	802	468	41		
Bar	0.4	0.6	0.8	1.0	1.2	1.4	1.6	1.8	2.0	2.2	2.4	2.6	2.8
Psi	6	9	12	15	17	20	23	26	29	32	35	38	41
10 km/h**	2475	2830	3185	3540	3955	4375	4790	5210	5625	5815	6000	6190	6375
30 km/h	1900	2285	2665	3050	3435	3815	4200	4375	4545	4720	4890		
40 km/h		2190	2550	2910	3275	3635	3995	4160	4325	4490	4655		
50 km/h		2100	2445	2795	3140	3490	3835	3995	4150	4310	4465		
65 km/h			2360	2685	3005	3325	3650	3800	3950	4100	4250		
70 km/h			2150	2445	2735	3030	3320	3460	3600	3735	3875		

Ø Pulgadas	Descripción	CAI	S mm	D mm	R' mm	Cdr. mm	Llanta recomendada	Llanta permitida	Cámara de aire (Código)	Volumen interno al 75% (litros)	Profundidad de la banda de rodamiento (mm)		
34	650/60R34 159D/155E TL NUEVO	556249	667	1651	762	4935	DW20B (A)	DW21B (A) DW23B (A)	823	500	38.5		
Bar	0.4	0.6	0.8	1	1.2	1.4	1.6	1.8	2	2.2	2.4	2.6	2.8
Psi	6	9	12	15	17	20	23	26	29	32	35	38	41
10 km/h**	2475	2800	3125	3450	3885	4320	4755	5190	5625	5860	6095	6330	6565
30 km/h	1900	2285	2665	3050	3435	3815	4200	4410	4615	4825	5030		
40 km/h		2190	2550	2910	3275	3635	3995	4195	4395	4590	4790		
50 km/h		2100	2445	2795	3140	3490	3835	4025	4215	4405	4595		
65 km/h			2300	2640	2975	3310	3650	3830	4015	4195	4375		
70 km/h			2095	2400	2710	3015	3320	3460	3600	3735	3875		

* Consultar las notas al final de las tablas de esta gama.

MICHELIN® ROADBIB

Características y presiones en (Bar) y (Psi): carga por neumático en kg*

Ø Pulgadas	Descripción	CAI	S mm	D mm	R' mm	Cdr. mm	Llanta recomendada	Llanta permitida	Cámara de aire (Código)	Volumen interno al 75% (litros)	Profundidad de la banda de rodamiento (mm)
34	650/65R34 161D/157E TL NUEVO	330378	674	1707	785	5098	DW20B (A)	DW21B (A) DW23B (A)	823	555	39.5
Bar	0.4 0.6 0.8 1 1.2 1.4 1.6 1.8 2 2.2 2.4 2.6 2.8										
Psi	6 9 12 15 17 20 23 26 29 32 35 38 41										
10 km/h**	2700 3090 3475 3865 4290 4720 5145 5575 6000 6235 6470 6705 6940										
30 km/h	2070 2470 2865 3265 3660 4055 4455 4670 4890 5105 5320										
40 km/h	2385 2755 3130 3500 3875 4245 4450 4655 4860 5065										
50 km/h	2290 2645 3000 3360 3715 4070 4265 4465 4660 4855										
65 km/h	2575 2900 3225 3550 3875 4065 4250 4440 4625										
70 km/h	2345 2640 2935 3230 3525 3675 3825 3975 4125										

Ø Pulgadas	Descripción	CAI	S mm	D mm	R' mm	Cdr. mm	Llanta recomendada	Llanta permitida	Cámara de aire (Código)	Volumen interno al 75% (litros)	Profundidad de la banda de rodamiento (mm)
42	650/65R42 165D/161E TL NUEVO	075643	633	1932	843	5693	DW20B (A)	DW23B (A) DW21B(A)	802	643	43.2
Bar	0.4 0.6 0.8 1 1.2 1.4 1.6 1.8 2 2.2 2.4 2.6 2.8										
Psi	6 9 12 15 17 20 23 26 29 32 35 38 41										
10 km/h**	3000 3400 3800 4200 4675 5145 5620 6090 6565 6855 7145 7435 7725										
30 km/h	2300 2730 3165 3595 4025 4460 4890 5150 5410 5665 5925										
40 km/h	2660 3060 3460 3855 4255 4655 4900 5150 5395 5640										
50 km/h	2550 2935 3315 3700 4080 4465 4700 4940 5175 5410										
65 km/h	2800 3165 3525 3890 4250 4475 4700 4925 5150										
70 km/h	2550 2880 3210 3540 3870 4060 4250 4435 4625										

Ø Pulgadas	Descripción	CAI	S mm	D mm	R' mm	Cdr. mm	Llanta recomendada	Llanta permitida	Cámara de aire (Código)	Volumen interno al 75% (litros)	Profundidad de la banda de rodamiento (mm)
42	710/70 R42 173D/170E TL	885975	708	2026	918	6019	DW23B (A)	DW25B (A)	802	867	39
Bar	0.4 0.6 0.8 1.0 1.2 1.4 1.6 1.8 2.0 2.2 2.4 2.6 2.8										
Psi	6 9 12 15 17 20 23 26 29 32 35 38 41										
10 km/h**	3750 4275 4800 5325 6000 6675 7350 8025 8700 8965 9225 9490 9750										
30 km/h	2875 3470 4065 4660 5250 5845 6440 6700 6960 7215 7475										
40 km/h	3285 3855 4425 4990 5560 6130 6380 6625 6875 7120										
50 km/h	3150 3695 4240 4790 5335 5880 6115 6355 6590 6825										
65 km/h	3550 4065 4575 5090 5600 5825 6050 6275 6500										
70 km/h	3230 3695 4165 4630 5095 5320 5550 5775 6000										

* Consultar las notas al final de las tablas de esta gama.

MICHELIN® ROADBIB

Características y presiones en (Bar) y (Psi): carga por neumático en kg*

Ø Pulgadas	Descripción	CAI	S mm	D mm	R' mm	Cdr. mm	Llanta recomendada	Llanta permitida	Cámara de aire (Código)	Volumen interno al 75% (litros)	Profundidad de la banda de rodamiento (mm)		
42	710/75R42 175D/171E TL NUEVO	378080	742	2143	964	6368	DW23B (A)	DW25B (A) DW21B(A)	802	950	43		
Bar	0.4	0.6	0.8	1	1.2	1.4	1.6	1.8	2	2.2	2.4	2.6	2.8
Psi	6	9	12	15	17	20	23	26	29	32	35	38	41
10 km/h**	3975	4525	5075	5625	6300	6975	7650	8325	9000	9340	9675	10015	10350
30 km/h	3050	3690	4335	4975	5615	6260	6900	7160	7420	7675	7935		
40 km/h		3560	4160	4765	5365	5970	6570	6815	7065	7310	7555		
50 km/h		3415	3990	4570	5145	5725	6300	6535	6775	7010	7245		
65 km/h			3750	4315	4875	5440	6000	6225	6450	6675	6900		
70 km/h			3415	3925	4440	4950	5460	5635	5805	5980	6150		

***IMPORTANTE:**

La presión de inflado se determina siempre en función de la carga por neumático, de la velocidad y del trabajo a realizar. Las recomendaciones anteriores se facilitan con la salvedad de modificaciones posteriores a la fecha de difusión de estas tablas (junio de 2018). Los datos técnicos pueden sufrir modificaciones sin previo aviso.

- Para arar y otras aplicaciones de campo sujetas a un alto torque, use la columna de 30 km/h.
 - Cuando se utiliza la configuración de montaje en simple (single):
 - Añadir 0.4 Bar para usar en pendientes superiores al 20%
 - Añadir 0.4 Bar para uso pesado en carreteras superiores al 50%
- **10 km/h LT (bajo torque) (velocidad máxima 10 km/h).



MICHELIN® AXIOBIB 2

ALTA CAPACIDAD DE TRACCIÓN PARA CARGAS PESADAS



Para tractores de **160 a 550 HP**



VF Very High Flexion



Suelos protegidos gracias a su baja presión de hasta 0.6 Bar



Más **tracción**, de **+28% a +35%**⁽¹⁾



Mejor **productividad** de **+7% a +11%**⁽¹⁾
Rendimiento de + 4% al año⁽²⁾

(1) Pruebas internas realizadas en 2016 dependiendo de la dimensión, comparación del neumático MICHELIN® AXIOBIB 2 VF 650/85 R42 con el neumático MICHELIN® MACHXBIB 650/85 R38.

(2) Universidad de Harper Adams 2014/2016.

DIMENSIONES

VF 540/65R30 158D/155E TL

VF 600/60R30 162D/159E TL

VF 600/70R30 168D/165E TL

VF 620/75R30 172D/169E TL

VF 650/60R34 168D/165E TL

VF 650/65R34 170D/167E TL

VF 710/60R34 173D/169E TL **NUEVO**

VF 650/60R38 170D/167E TL

VF 650/85R38 182D/179E TL

VF 800/70R38 187D/184E TL

VF 710/60R42 176D/173E TL

VF 650/65R42 174D/171E TL

VF 710/70R42 182D/179E TL

VF 710/75R42 184D/180E TL

VF 900/60R42 189D/185E TL **NUEVO**

VF 650/85R42 183D/180E TL

VF 750/70R44 186D/183E TL

MICHELIN® AXIOBIB 2

Características y presiones en (Bar) y (Psi): carga por neumático en kg*

Ø Pulgadas	Descripción	CAI	S mm	D mm	R' mm	Cdr. mm	Llanta recomendada	Llanta permitida	Cámara de aire (Código)	Volumen interno al 75% (litros)	Profundidad de la banda de rodamiento (mm)			
30	VF 540/65R30 158D/155E TL	296638	536	1460	641	4316	W18L	W16L	754	332	48			
Bar	0.6 0.8 0.9 1 1.1 1.2 1.3 1.4 1.5 1.6 1.7 1.8 1.9 2													
Psi	9 12 13 15 16 17 19 20 22 23 25 26 28 29													
10 km/h**	2400	2750	2940	3130	3320	3510	3695	3885	4075	4265	4370	4470	4575	4675
30 km/h	2225	2550	2725	2900	3075	3255	3430	3605	3780	3955	4050	4145	4240	4335
65 km/h	2180	2500	2670	2845	3015	3190	3360	3530	3705	3875	3970	4065	4155	4250
65 km/h Dual	1920	2180	2310	2440	2570	2700	2830	2960	3090	3220	3350	3480	3610	3740
70 km/h	2000	2330	2495	2655	2820	2985	3130	3270	3415	3555	3640	3730	3815	3900

Ø Pulgadas	Descripción	CAI	S mm	D mm	R' mm	Cdr. mm	Llanta recomendada	Llanta permitida	Cámara de aire (Código)	Volumen interno al 75% (litros)	Profundidad de la banda de rodamiento (mm)			
30	VF 600/60R30 162D/159E TL	371968	597	1468	643	4336	DW20B (A)	DW18L	757	381	49			
Bar	0.4 0.6 0.8 0.9 1 1.1 1.2 1.3 1.4 1.5 1.6 1.7 1.8 1.9 2													
Psi	6 9 12 13 15 16 17 19 20 22 23 25 26 28 29													
10 km/h**	2530	2965	3180	3395	3605	3820	4035	4250	4460	4675	4815	4950	5090	5225
30 km/h	2345	2750	2950	3145	3345	3545	3740	3940	4135	4335	4465	4590	4720	4845
65 km/h	2300	2695	2890	3085	3280	3475	3665	3860	4055	4250	4375	4500	4625	4750
65 km/h Dual	1715	2055	2390	2550	2715	2875	3035	3210	3390	3565	3740	3850	3960	4070
70 km/h	2095	2445	2620	2790	2965	3140	3325	3505	3690	3870	3985	4100	4210	4325

Ø Pulgadas	Descripción	CAI	S mm	D mm	R' mm	Cdr. mm	Llanta recomendada	Llanta permitida	Cámara de aire (Código)	Volumen interno al 75% (litros)	Profundidad de la banda de rodamiento (mm)			
30	VF 600/70R30 168D/165E TL	426719	624	1579	689	4659	DW21B (A)	DW20B (A)	737	468	58			
Bar	0.4 0.6 0.8 0.9 1 1.1 1.2 1.3 1.4 1.5 1.6 1.7 1.8 1.9 2													
Psi	6 9 12 13 15 16 17 19 20 22 23 25 26 28 29													
10 km/h**	3080	3575	3835	4100	4360	4620	4880	5145	5405	5665	5790	5915	6035	6160
30 km/h	2855	3315	3560	3800	4045	4285	4530	4770	5015	5255	5370	5485	5595	5710
65 km/h	2800	3250	3490	3725	3965	4200	4440	4675	4915	5150	5265	5375	5490	5600
65 km/h Dual	2075	2470	2860	3080	3300	3520	3740	3940	4135	4335	4530	4630	4730	4830
70 km/h	2550	2990	3210	3430	3650	3870	4075	4280	4480	4685	4790	4890	4995	5095

* Consultar las notas al final de las tablas de esta gama.

MICHELIN® AXIOBIB 2

Características y presiones en (Bar) y (Psi): carga por neumático en kg*

Ø Pulgadas	Descripción	CAI	S mm	D mm	R' mm	Cdr. mm	Llanta recomendada	Llanta permitida	Cámara de aire (Código)	Volumen interno al 75% (litros)	Profundidad de la banda de rodamiento (mm)
30	VF 620/75R30 172D/169E TL	702894	662	1670	722	4919	DW23B (A)	DW20B (A) DW21B (A)	737	556	58
Bar	0.6 0.8 0.9 1 1.1 1.2 1.3 1.4 1.5 1.6 1.7 1.8 1.9 2										
Psi	9 12 13 15 16 17 19 20 22 23 25 26 28 29										
10 km/h**	3465 4015 4310 4605 4900 5200 5495 5790 6085 6380 6520 6655 6795 6930										
30 km/h	3215 3725 4000 4275 4545 4820 5095 5370 5640 5915 6045 6170 6300 6425										
65 km/h	3150 3650 3920 4190 4455 4725 4995 5265 5530 5800 5925 6050 6175 6300										
65 km/h Dual	2770 3165 3365 3565 3760 3960 4160 4355 4555 4750 4950 5150 5345 5545										
70 km/h	2890 3380 3625 3870 4115 4360 4600 4845 5085 5325 5440 5555 5670 5785										

Ø Pulgadas	Descripción	CAI	S mm	D mm	R' mm	Cdr. mm	Llanta recomendada	Llanta permitida	Cámara de aire (Código)	Volumen interno al 75% (litros)	Profundidad de la banda de rodamiento (mm)
34	VF 650/60R34 168D/165E TL	202185	677	1653	732	4895	DW23B (A)	DW21B (A) DW24B (A)	823	500	58
Bar	0.4 0.6 0.8 0.9 1 1.1 1.2 1.3 1.4 1.5 1.6 1.7 1.8 1.9 2										
Psi	6 9 12 13 15 16 17 19 20 22 23 25 26 28 29										
10 km/h**	3080 3565 3830 4090 4355 4615 4880 5140 5405 5665 5790 5915 6035 6160										
30 km/h	2855 3305 3550 3795 4035 4280 4525 4770 5010 5255 5370 5485 5595 5710										
65 km/h	2800 3240 3480 3720 3955 4195 4435 4675 4910 5150 5265 5375 5490 5600										
65 km/h Dual	2025 2445 2860 3055 3245 3440 3630 3855 4080 4305 4530 4630 4730 4830 4930										
70 km/h	2580 2985 3190 3395 3595 3800 4035 4275 4510 4745 4845 4950 5050 5150										

Ø Pulgadas	Descripción	CAI	S mm	D mm	R' mm	Cdr. mm	Llanta recomendada	Llanta permitida	Cámara de aire (Código)	Volumen interno al 75% (litros)	Profundidad de la banda de rodamiento (mm)
34	VF 650/65R34 170D/167E TL	101906	679	1710	756	5061	DW23B (A)	DW21B (A)	823	600	58
Bar	0.4 0.6 0.8 0.9 1 1.1 1.2 1.3 1.4 1.5 1.6 1.7 1.8 1.9 2										
Psi	6 9 12 13 15 16 17 19 20 22 23 25 26 28 29										
10 km/h**	3385 3950 4205 4460 4715 4975 5230 5485 5740 5995 6145 6300 6450 6600										
30 km/h	3135 3660 3900 4135 4375 4610 4850 5085 5325 5560 5700 5840 5980 6120										
65 km/h	3075 3590 3825 4055 4290 4520 4755 4985 5220 5450 5590 5725 5865 6000										
65 km/h Dual	2265 2695 3125 3360 3600 3835 4070 4250 4435 4615 4795 4915 5040 5160 5280										
70 km/h	2830 3305 3545 3785 4020 4260 4450 4640 4830 5020 5145 5275 5400 5525										

* Consultar las notas al final de las tablas de esta gama.

MICHELIN® AXIOBIB 2

Características y presiones en (Bar) y (Psi): carga por neumático en kg*

Ø Pulgadas	Descripción	CAI	S mm	D mm	R' mm	Cdr. mm	Llanta recomendada	Llanta permitida	Cámara de aire (Código)	Volumen interno al 75% (litros)	Profundidad de la banda de rodamiento (mm)				
34	VF 710/60R34 173D/169E TL NUEVO	757609	731	1727	754	5093	DW25B (A)	DW23B (A) (NRO) MW25B (A)		613	58				
Bar	0.4	0.6	0.8	0.9	1	1.1	1.2	1.3	1.4	1.5	1.6	1.7	1.8	1.9	2
Psi	6	9	12	13	15	16	17	19	20	22	23	25	26	28	29
10 km/h**		3465	4125	4405	4690	4970	5255	5535	5815	6100	6380	6575	6765	6960	7150
30 km/h		3215	3825	4085	4350	4610	4870	5130	5395	5655	5915	6095	6275	6450	6630
65 km/h		3150	3750	4005	4265	4520	4775	5030	5290	5545	5800	5975	6150	6325	6500
65 km/h Dual	2330	2815	3300	3520	3740	3960	4180	4410	4645	4875	5105	5260	5415	5565	5720
70 km/h		2865	3350	3595	3840	4080	4325	4565	4805	5040	5280	5410	5540	5670	5800

Ø Pulgadas	Descripción	CAI	S mm	D mm	R' mm	Cdr. mm	Llanta recomendada	Llanta permitida	Cámara de aire (Código)	Volumen interno al 75% (litros)	Profundidad de la banda de rodamiento (mm)				
38	VF 650/60R38 170D/167E TL	908973	668	1742	772	5145	DW23B (A)	DW20B (A) MW23B (A)	825	540	58				
Bar	0.4	0.6	0.8	0.9	1	1.1	1.2	1.3	1.4	1.5	1.6	1.7	1.8	1.9	2
Psi	6	9	12	13	15	16	17	19	20	22	23	25	26	28	29
10 km/h**		3190	3795	4050	4305	4560	4815	5065	5320	5575	5830	6025	6215	6410	6600
30 km/h		2960	3520	3755	3990	4225	4465	4700	4935	5170	5405	5585	5765	5940	6120
65 km/h		2900	3450	3680	3915	4145	4375	4605	4840	5070	5300	5475	5650	5825	6000
65 km/h Dual	2140	2590	3035	3240	3445	3645	3850	4055	4260	4460	4665	4820	4975	5125	5280
70 km/h		2640	3085	3310	3535	3755	3980	4190	4405	4615	4825	4985	5145	5300	5460

Ø Pulgadas	Descripción	CAI	S mm	D mm	R' mm	Cdr. mm	Llanta recomendada	Llanta permitida	Cámara de aire (Código)	Volumen interno al 75% (litros)	Profundidad de la banda de rodamiento (mm)				
38	VF 650/85R38 182D/179E TL	655949	680	2063	900	6088	DW23B (A)	DW20B (A) DW21B	804	857	63				
Bar	0.4	0.6	0.8	0.9	1	1.1	1.2	1.3	1.4	1.5	1.6	1.7	1.8	1.9	2
Psi	6	9	12	13	15	16	17	19	20	22	23	25	26	28	29
10 km/h**		4675	5365	5760	6155	6550	6945	7340	7735	8130	8525	8730	8940	9145	9350
30 km/h		4335	4975	5340	5710	6075	6440	6805	7175	7540	7905	8095	8290	8480	8670
65 km/h		4250	4875	5235	5595	5955	6315	6670	7030	7390	7750	7940	8125	8315	8500
65 km/h Dual	3125	3710	4290	4605	4920	5230	5545	5865	6185	6500	6820	6985	7150	7315	7480
70 km/h		3870	4490	4805	5115	5425	5735	6065	6395	6725	7055	7230	7405	7575	7750

* Consultar las notas al final de las tablas de esta gama.

MICHELIN® AXIOBIB 2

Características y presiones en (Bar) y (Psi): carga por neumático en kg*

Ø Pulgadas	Descripción	CAI	S mm	D mm	R' mm	Cdr. mm	Llanta recomendada	Llanta permitida	Cámara de aire (Código)	Volumen interno al 75% (litros)	Profundidad de la banda de rodamiento (mm)				
38	VF 800/70R38 187D/184E TL	136377	821	2072	891	6096	DW27B (A)	DW25B (A)	804	1073	63				
Bar	0.4 0.6 0.8 0.9	1 1.1 1.2 1.3 1.4 1.5 1.6	1.7 1.8 1.9 2												
Psi	6 9 12 13	15 16 17 19 20 22 23	25 26 28 29												
10 km/h**	5365	6380	6820	7260	7700	8140	8580	9020	9460	9900	10105	10315	10520	10725	
30 km/h	4975	5915	6325	6730	7140	7550	7955	8365	8770	9180	9370	9565	9755	9945	
65 km/h	4875	5800	6200	6600	7000	7400	7800	8200	8600	9000	9190	9375	9565	9750	
65 km/h Dual	3630	4370	5105	5435	5765	6095	6425	6800	7175	7545	7920	8085	8250	8415	8580
70 km/h	4435	5170	5540	5910	6275	6645	7030	7420	7805	8190	8395	8595	8800	9000	

Ø Pulgadas	Descripción	CAI	S mm	D mm	R' mm	Cdr. mm	Llanta recomendada	Llanta permitida	Cámara de aire (Código)	Volumen interno al 75% (litros)	Profundidad de la banda de rodamiento (mm)				
42	VF 710/60R42 176D/173E TL	941770	730	1885	830	5574	DW25B (A)	DW23B (A) MW25B (A)	802	710	58				
Bar	0.4 0.6 0.8 0.9	1 1.1 1.2 1.3 1.4 1.5 1.6	1.7 1.8 1.9 2												
Psi	6 9 12 13	15 16 17 19 20 22 23	25 26 28 29												
10 km/h**	3795	4540	4865	5195	5520	5845	6170	6495	6825	7150	7315	7480	7645	7810	
30 km/h	3520	4210	4515	4815	5120	5420	5725	6025	6330	6630	6785	6935	7090	7240	
65 km/h	3450	4125	4420	4720	5015	5315	5610	5905	6205	6500	6650	6800	6950	7100	
65 km/h Dual	2550	3090	3630	3890	4150	4405	4665	4930	5195	5455	5720	5855	5985	6120	6250
70 km/h	3140	3700	3985	4265	4545	4825	5100	5370	5645	5915	6050	6190	6325	6460	

Ø Pulgadas	Descripción	CAI	S mm	D mm	R' mm	Cdr. mm	Llanta recomendada	Llanta permitida	Cámara de aire (Código)	Volumen interno al 75% (litros)	Profundidad de la banda de rodamiento (mm)				
42	VF 650/65R42 174D/171E TL	387916	666	1920	847	5680	DW23B (A)	DW20B (A) DW21B(A)	802	643	58				
Bar	0.4 0.6 0.8 0.9	1 1.1 1.2 1.3 1.4 1.5 1.6	1.7 1.8 1.9 2												
Psi	6 9 12 13	15 16 17 19 20 22 23	25 26 28 29												
10 km/h**	3685	4400	4675	4950	5225	5500	5775	6050	6325	6600	6795	6985	7180	7370	
30 km/h	3415	4080	4335	4590	4845	5100	5355	5610	5865	6120	6300	6480	6655	6835	
65 km/h	3350	4000	4250	4500	4750	5000	5250	5500	5750	6000	6175	6350	6525	6700	
65 km/h Dual	2465	2995	3520	3740	3960	4180	4400	4620	4840	5060	5280	5435	5590	5740	5895
70 km/h	3075	3580	3835	4085	4340	4590	4820	5050	5275	5505	5665	5830	5990	6150	

* Consultar las notas al final de las tablas de esta gama.

MICHELIN® AXIOBIB 2

Características y presiones en (Bar) y (Psi): carga por neumático en kg*

Ø Pulgadas	Descripción	CAI	S mm	D mm	R' mm	Cdr. mm	Llanta recomendada	Llanta permitida	Cámara de aire (Código)	Volumen interno al 75% (litros)	Profundidad de la banda de rodamiento (mm)				
42	VF 710/70R42 182D/179E TL	523668	731	2066	906	6104	DW25B (A)	DW23B (A) MW25B (A)	802	867	63				
Bar	0.4 0.6 0.8 0.9	1 1.1 1.2 1.3 1.4 1.5 1.6 1.7 1.8 1.9 2													
Psi	6 9 12 13	15 16 17 19 20 22 23 25 26 28 29													
10 km/h**		4675	5500	5880	6255	6635	7015	7390	7770	8145	8525	8730	8940	9145	9350
30 km/h		4335	5100	5450	5800	6150	6505	6855	7205	7555	7905	8095	8290	8480	8670
65 km/h		4250	5000	5345	5690	6030	6375	6720	7065	7405	7750	7940	8125	8315	8500
65 km/h Dual	3125	3765	4400	4685	4975	5260	5545	5865	6185	6500	6820	6985	7150	7315	7480
70 km/h		3870	4490	4805	5115	5425	5735	6065	6395	6725	7055	7230	7405	7575	7750

Ø Pulgadas	Descripción	CAI	S mm	D mm	R' mm	Cdr. mm	Llanta recomendada	Llanta permitida	Cámara de aire (Código)	Volumen interno al 75% (litros)	Profundidad de la banda de rodamiento (mm)				
42	VF 710/75R42 184D/180E TL	259635	737	2153	950	6370	DW25B (A)		802	945	65				
Bar	0.4 0.6 0.8 0.9	1 1.1 1.2 1.3 1.4 1.5 1.6 1.7 1.8 1.9 2													
Psi	6 9 12 13	15 16 17 19 20 22 23 25 26 28 29													
10 km/h**		4950	5760	6175	6590	7005	7420	7830	8245	8660	9075	9280	9490	9695	9900
30 km/h		4590	5340	5725	6110	6495	6880	7260	7645	8030	8415	8605	8800	8990	9180
65 km/h		4500	5235	5610	5990	6365	6745	7120	7495	7875	8250	8440	8625	8815	9000
65 km/h Dual	3300	3985	4665	4975	5280	5590	5895	6235	6580	6920	7260	7425	7590	7755	7920
70 km/h		4145	4820	5160	5495	5835	6170	6530	6885	7245	7600	7700	7800	7900	8000

Ø Pulgadas	Descripción	CAI	S mm	D mm	R' mm	Cdr. mm	Llanta recomendada	Llanta permitida	Cámara de aire (Código)	Volumen interno al 75% (litros)	Profundidad de la banda de rodamiento (mm)				
42	VF 900/60R42 189D/185E TL NUEVO	428922	881	2158	942	6357	DW30B (A)	DW28B (A)		1230	64				
Bar	0.4 0.6 0.8 0.9	1 1.1 1.2 1.3 1.4 1.5 1.6 1.7 1.8 1.9 2													
Psi	6 9 12 13	15 16 17 19 20 22 23 25 26 28 29													
10 km/h**		5550	6475	6940	7400	7865	8325	8790	9250	9715	10175	10465	10755	11040	11330
30 km/h		5145	6005	6435	6865	7290	7720	8150	8580	9005	9435	9705	9970	10240	10505
65 km/h		5045	5885	6305	6725	7145	7565	7985	8410	8830	9250	9515	9775	10040	10300
65 km/h Dual	3665	4440	5180	5550	5920	6290	6660	7030	7400	7770	8140	8370	8605	8835	9065
70 km/h		4590	5355	5740	6120	6505	6885	7270	7655	8035	8420	8630	8835	9045	9250

* Consultar las notas al final de las tablas de esta gama.

MICHELIN® AXIOBIB 2

Características y presiones en (Bar) y (Psi): carga por neumático en kg*

Ø Pulgadas	Descripción	CAI	S mm	D mm	R' mm	Cdr. mm	Llanta recomendada	Llanta permitida	Cámara de aire (Código)	Volumen interno al 75% (litros)	Profundidad de la banda de rodamiento (mm)			
42	VF 650/85R42 183D/180E TL	530764	670	2164	948	6393	DW23B (A)	DW21B(A)	802	914	61			
Bar	0.6	0.8	0.9	1	1.1	1.2	1.3	1.4	1.5	1.6	1.7	1.8	1.9	2
Psi	9	12	13	15	16	17	19	20	22	23	25	26	28	29
10 km/h**	4815	5665	6055	6450	6840	7235	7625	8015	8410	8800	9005	9215	9420	9625
30 km/h	4465	5255	5620	5980	6345	6710	7070	7435	7795	8160	8350	8545	8735	8925
65 km/h	4375	5150	5505	5865	6220	6575	6930	7290	7645	8000	8190	8375	8565	8750
65 km/h Dual	3850	4400	4675	4950	5225	5500	5775	6050	6325	6600	6875	7150	7425	7700
70 km/h	4015	4665	4990	5315	5640	5965	6310	6655	7000	7345	7515	7690	7860	8030

Ø Pulgadas	Descripción	CAI	S mm	D mm	R' mm	Cdr. mm	Llanta recomendada	Llanta permitida	Cámara de aire (Código)	Volumen interno al 75% (litros)	Profundidad de la banda de rodamiento (mm)				
44	VF 750/70R44 186D/183E TL	681569	763	2180	956	6438	DW25B (A)	MW25B (A) MW24B (A) DW24B (A)		1016	64				
Bar	0.4	0.6	0.8	0.9	1	1.1	1.2	1.3	1.4	1.5	1.6	1.7	1.8	1.9	2
Psi	6	9	12	13	15	16	17	19	20	22	23	25	26	28	29
10 km/h**		5225	6090	6530	6975	7415	7860	8300	8740	9185	9625	9830	10040	10245	10450
30 km/h		4845	5645	6055	6465	6875	7285	7695	8105	8515	8925	9115	9310	9500	9690
65 km/h		4750	5535	5935	6340	6740	7145	7545	7945	8350	8750	8940	9125	9315	9500
65 km/h Dual	3410	4105	4795	5160	5525	5885	6250	6615	6975	7340	7700	7865	8030	8195	8360
70 km/h		4375	5095	5460	5820	6180	6540	6920	7300	7680	8060	8235	8405	8580	8750

***IMPORTANTE:**

La presión de inflado se determina siempre en función de la carga por neumático, de la velocidad y del trabajo a realizar. Las recomendaciones anteriores se facilitan con la salvedad de modificaciones posteriores a la fecha de difusión de estas tablas (junio de 2018). Los datos técnicos pueden sufrir modificaciones sin previo aviso.

- Cuando se usa la configuración de montaje simple (single):
 - Añadir 0.4 Bar para usar en pendientes superiores al 20%
 - Añadir 0.4 Bar para uso pesado en carreteras superiores al 50%
 - (NRO): Opción de aro estrecho - cuando use NRO, agregue 0.2 Bar.
- **10 km/h LT (torque bajo) (velocidad máxima 10 km/h).



MICHELIN® AXIOBIB

**MEJOR TRACCIÓN Y
PROTECCIÓN DE LOS SUELOS
PARA TRACTORES DE
POTENCIAS MUY ALTAS**



Para tractores de alta potencia de **250 HP y más**



Norma Improved Flexion (IF)

0.8 Bar menos de presión o más de 2.5 kg de capacidad de carga adicional por eje



Mejor RENDIMIENTO +4% /al año⁽¹⁾



Hasta un **15% de ahorro en combustible** al trabajar en el campo⁽²⁾



+11% de tracción con AXIOBIB IF 710/70R42 frente a un neumático estándar 710/70R42



Suelos protegidos gracias a su baja presión de hasta 0.8 Bar



(1) Universidad de Harper Adams 2014/2016.

(2) Media comprobada en comparación con una dimensión estándar durante las pruebas en el campo.

DIMENSIONES

IF 600/70 R30 159A8/156B TL
 IF 600/70 R30 159D TL
 IF 620/75 R30 164D TL
 IF 650/75 R30 166D TL
 IF 480/70 R34 150A8/147B TL
 IF 650/60 R34 165D TL

IF 650/65 R34 161D TL
 IF 710/60 R34 164D TL
 IF 650/65 R38 169D TL
 IF 800/70 R38 179A8/176B TL
 IF 650/85 R38 179A8/176B TL
 IF 650/85 R38 179D TL

IF 710/60 R38 172D TL
 IF 710/85 R38 178D TL
 IF 800/70 R38 179A8/B
 IF 800/70 R38 179D TL
 IF 710/70 R42 179A8/176B TL
 IF 710/70 R42 179D TL

IF 710/75 R42 176D TL
 IF 900/60 R42 186D TL
 IF 750/75 R46 186D TL
 IF 900/65 R46 190D TL

MICHELIN® AXIOBIB

Características y presiones en (Bar) y (Psi): carga por neumático en kg*

Ø Pulgadas	Descripción	CAI	S mm	D mm	R' mm	Cdr. mm	Llanta recomendada	Llanta permitida	Cámara de aire (Código)	Volumen interno al 75% (litros)	Profundidad de la banda de rodamiento (mm)
30	IF 600/70 R30 159A8/156B TL	338729	600	1585	695	4683	DW21B (A)	DW20B (A)	737	450	56
Bar	0.4 0.6 0.8 1.0 1.2 1.4 1.6 1.7 1.8 1.9 2.0 2.1 2.2 2.3 2.4										
Psi	6 9 12 15 17 20 23 25 26 28 29 30 32 33 35										
40 km/h Dual	1760 2115 2465 2840 3210 3530 3850										
40 km/h	2800 3225 3650 4015 4375										
50 km/h	2550 2885 3220 3600 3980										

Ø Pulgadas	Descripción	CAI	S mm	D mm	R' mm	Cdr. mm	Llanta recomendada	Llanta permitida	Cámara de aire (Código)	Volumen interno al 75% (litros)	Profundidad de la banda de rodamiento (mm)
30	IF 600/70 R30 159D TL	280086	600	1585	695	4683	DW21B (A)	DW20B (A)	737	450	56
Bar	0.4 0.6 0.8 1.0 1.2 1.4 1.6 1.7 1.8 1.9 2.0 2.1 2.2 2.3 2.4										
Psi	6 9 12 15 17 20 23 25 26 28 29 30 32 33 35										
65 km/h	2800 3225 3650 4015 4375										
65 km/h Dual	1760 2110 2460 2835 3210 3530 3850										

Ø Pulgadas	Descripción	CAI	S mm	D mm	R' mm	Cdr. mm	Llanta recomendada	Llanta permitida	Cámara de aire (Código)	Volumen interno al 75% (litros)	Profundidad de la banda de rodamiento (mm)
30	IF 620/75 R30 164D TL	668406	659	1670	728	4927	DW23B (A)	DW21B (A) MW23B(A)	737	570	58
Bar	0.4 0.6 0.8 1.0 1.2 1.4 1.6 1.7 1.8 1.9 2.0 2.1 2.2 2.3 2.4										
Psi	6 9 12 15 17 20 23 25 26 28 29 30 32 33 35										
65 km/h	3150 3575 4000 4500 5000										
65 km/h Dual	1970 2370 2770 3145 3520 3960 4400										

Ø Pulgadas	Descripción	CAI	S mm	D mm	R' mm	Cdr. mm	Llanta recomendada	Llanta permitida	Cámara de aire (Código)	Volumen interno al 75% (litros)	Profundidad de la banda de rodamiento (mm)
30	IF 650/75 R30 166D TL	828322	679	1721	745	5071	DW23B (A)	MW23B(A)		638	57
Bar	0.4 0.6 0.8 1.0 1.2 1.4 1.6 1.7 1.8 1.9 2.0 2.1 2.2 2.3 2.4										
Psi	6 9 12 15 17 20 23 25 26 28 29 30 32 33 35										
65 km/h	3450 3915 4375 4840 5300										
65 km/h Dual	2140 2590 3040 3445 3850 4255 4660										

Ø Pulgadas	Descripción	CAI	S mm	D mm	R' mm	Cdr. mm	Llanta recomendada	Llanta permitida	Cámara de aire (Código)	Volumen interno al 75% (litros)	Profundidad de la banda de rodamiento (mm)
34	IF 710/60 R34 164D TL	712503	708	1696	756	5030	DW25B (A)			615	58
Bar	0.4 0.6 0.8 1.0 1.2 1.4 1.6 1.7 1.8 1.9 2.0 2.1 2.2 2.3 2.4										
Psi	6 9 12 15 17 20 23 25 26 28 29 30 32 33 35										
65 km/h	3150 3640 4125 4565 5000										
65 km/h Dual	1970 2370 2770 3200 3630 4015 4400										

* Consultar las notas al final de las tablas de esta gama.

MICHELIN® AXIOBIB

Características y presiones en (Bar) y (Psi): carga por neumático en kg*

Ø Pulgadas	Descripción	CAI	S mm	D mm	R' mm	Cdr. mm	Llanta recomendada	Llanta permitida	Cámara de aire (Código)	Volumen interno al 75% (litros)	Profundidad de la banda de rodamiento (mm)				
38	IF 710/60 R38 172D TL	220975	710	1844	834	5486	DW25B (A)		825	661	58				
Bar	0.4 0.6 0.8 1.0 1.2 1.4 1.6 1.7 1.8 1.9 2.0 2.1 2.2 2.3 2.4														
Psi	6 9 12 15 17 20 23 25 26 28 29 30 32 33 35														
65 km/h		3350	3840	4325	4815	5300	5425	5550	5675	5800	5925	6050	6175	6300	
65 km/h Dual	2080 2540	3000	3405	3815	4220	4625	4740	4855	4970	5085	5200	5315	5430	5545	

Ø Pulgadas	Descripción	CAI	S mm	D mm	R' mm	Cdr. mm	Llanta recomendada	Llanta permitida	Cámara de aire (Código)	Volumen interno al 75% (litros)	Profundidad de la banda de rodamiento (mm)				
34	IF 650/65 R34 161D TL	711975	653	1721	764	5099	DW23B (A)		823	555	58				
Bar	0.4 0.6 0.8 1.0 1.2 1.4 1.6 1.7 1.8 1.9 2.0 2.1 2.2 2.3 2.4														
Psi	6 9 12 15 17 20 23 25 26 28 29 30 32 33 35														
65 km/h		3075	3540	4000	4315	4625									
65 km/h Dual	1920 2315	2710	3115	3520	3795	4070									

Ø Pulgadas	Descripción	CAI	S mm	D mm	R' mm	Cdr. mm	Llanta recomendada	Llanta permitida	Cámara de aire (Código)	Volumen interno al 75% (litros)	Profundidad de la banda de rodamiento (mm)				
34	IF 480/70 R34 150A3/147B TL	324646	482	1590	705	4732	W15L (NRO)	«DW14L, DW15A (NRO), DW15L (NRO), DW16A, W14L, W15A (NRO), W16A, W16L	704	304	52				
Bar	0.4 0.6 0.8 1.0 1.2 1.4 1.6 1.7 1.8 1.9 2.0 2.1 2.2 2.3 2.4														
Psi	6 9 12 15 17 20 23 25 26 28 29 30 32 33 35														
40 km/h Dual	1320 1595	1865	2135	2400	2675	2950									
40 km/h		2120	2425	2725	3040	3350									
50 km/h		1930	2205	2480	2765	3050									

Ø Pulgadas	Descripción	CAI	S mm	D mm	R' mm	Cdr. mm	Llanta recomendada	Llanta permitida	Cámara de aire (Código)	Volumen interno al 75% (litros)	Profundidad de la banda de rodamiento (mm)				
38	IF 650/65 R38 169D TL	508421	649	1826	833	5446	DW23B (A)	MN21B(A)	825	599	58				
Bar	0.4 0.6 0.8 1.0 1.2 1.4 1.6 1.7 1.8 1.9 2.0 2.1 2.2 2.3 2.4														
Psi	6 9 12 15 17 20 23 25 26 28 29 30 32 33 35														
65 km/h		3250	3690	4125	4500	4875	4990	5105	5220	5340	5455	5570	5685	5800	
65 km/h Dual	2025 2445	2860	3245	3630	3960	4290	4390	4495	4595	4695	4795	4900	5000	5100	

Ø Pulgadas	Descripción	CAI	S mm	D mm	R' mm	Cdr. mm	Llanta recomendada	Llanta permitida	Cámara de aire (Código)	Volumen interno al 75% (litros)	Profundidad de la banda de rodamiento (mm)				
38	IF 650/85 R38 179D TL	084900	692	2050	913	6078	DW23B (A)	MW23B (A)	804	900	63				
Bar	0.4 0.6 0.8 1.0 1.2 1.4 1.6 1.7 1.8 1.9 2.0 2.1 2.2 2.3 2.4														
Psi	6 9 12 15 17 20 23 25 26 28 29 30 32 33 35														
65 km/h		4250	4850	5450	6075	6700	6850	7000	7150	7300	7415	7525	7640	7750	
65 km/h Dual	2640 3190	3740	4270	4800	5350	5900	6030	6160	6290	6420	6520	6620	6720	6820	

* Consultar las notas al final de las tablas de esta gama.

MICHELIN® AXIOBIB

Características y presiones en (Bar) y (Psi): carga por neumático en kg*

Ø Pulgadas	Descripción	CAI	S mm	D mm	R' mm	Cdr. mm	Llanta recomendada	Llanta permitida	Cámara de aire (Código)	Volumen interno al 75% (litros)	Profundidad de la banda de rodamiento (mm)
38	IF 650/85 R38 179A8/176B TL	075523	692	2050	913	6078	DW23B (A)	MW23B (A)	804	900	63
Bar	0.4 0.6 0.8 1.0 1.2 1.4 1.6 1.7 1.8 1.9 2.0 2.1 2.2 2.3 2.4										
Psi	6 9 12 15 17 20 23 25 26 28 29 30 32 33 35										
40 km/h Dual	2640 3190 3740 4270 4795 5345 5895 6010 6125 6240 6360 6475 6590 6705 6820										
40 km/h	4250 4850 5450 6075 6700 6830 6965 7095 7225 7355 7490 7620 7750										
50 km/h	3870 4415 4960 5530 6095 6215 6335 6455 6575 6695 6815 6935 7055										

Ø Pulgadas	Descripción	CAI	S mm	D mm	R' mm	Cdr. mm	Llanta recomendada	Llanta permitida	Cámara de aire (Código)	Volumen interno al 75% (litros)	Profundidad de la banda de rodamiento (mm)
38	IF 800/70 R38 179A8/176B TL	748361	810	2067	894	6089	DW27B (A)		804	1088	63
Bar	0.4 0.6 0.8 1.0 1.2 1.4 1.6 1.7 1.8 1.9 2.0 2.1 2.2 2.3 2.4										
Psi	6 9 12 15 17 20 23 25 26 28 29 30 32 33 35										
40 km/h Dual	3035 3665 4290 4920 5545 6185 6820										
40 km/h	4875 5590 6300 7025 7750										
50 km/h	4435 5085 5735 6395 7055										

Ø Pulgadas	Descripción	CAI	S mm	D mm	R' mm	Cdr. mm	Llanta recomendada	Llanta permitida	Cámara de aire (Código)	Volumen interno al 75% (litros)	Profundidad de la banda de rodamiento (mm)
38	IF 800/70 R38 179D TL	528166	810	2067	894	6089	DW27B (A)		804	1088	63
Bar	0.4 0.6 0.8 1.0 1.2 1.4 1.6 1.7 1.8 1.9 2.0 2.1 2.2 2.3 2.4										
Psi	6 9 12 15 17 20 23 25 26 28 29 30 32 33 35										
65 km/h	4875 5590 6300 7025 7750										
65 km/h Dual	3040 3665 4290 4915 5540 6180 6820										

Ø Pulgadas	Descripción	CAI	S mm	D mm	R' mm	Cdr. mm	Llanta recomendada	Llanta permitida	Cámara de aire (Código)	Volumen interno al 75% (litros)	Profundidad de la banda de rodamiento (mm)
38	IF 710/85 R38 178D TL	992951	734	2159	937	6365	DW25B (A)	MW25B (A)	804	1088	65
Bar	0.4 0.6 0.8 1.0 1.2 1.4 1.6 1.7 1.8 1.9 2.0 2.1 2.2 2.3 2.4										
Psi	6 9 12 15 17 20 23 25 26 28 29 30 32 33 35										
65 km/h	4875 5515 6150 6825 7500										
65 km/h Dual	3040 3665 4290 4850 5410 6005 6600										

Ø Pulgadas	Descripción	CAI	S mm	D mm	R' mm	Cdr. mm	Llanta recomendada	Llanta permitida	Cámara de aire (Código)	Volumen interno al 75% (litros)	Profundidad de la banda de rodamiento (mm)
42	IF 710/70 R42 179A8/176B TL	339858	742	2050	919	6089	DW25B (A)	DW23B, MW25B (A)	802	867	65
Bar	0.4 0.6 0.8 1.0 1.2 1.4 1.6 1.7 1.8 1.9 2.0 2.1 2.2 2.3 2.4										
Psi	6 9 12 15 17 20 23 25 26 28 29 30 32 33 35										
40 km/h Dual	2640 3190 3740 4270 4795 5345 5895 6010 6125 6240 6360 6475 6590 6705 6820										
40 km/h	3870 4415 4960 5530 6095 6215 6335 6455 6575 6695 6815 6935 7055										
50 km/h	4250 4850 5450 6075 6700 6830 6965 7095 7225 7355 7490 7620 7750										

* Consultar las notas al final de las tablas de esta gama.

MICHELIN® AXIOBIB

Características y presiones en (Bar) y (Psi): carga por neumático en kg*

Ø Pulgadas	Descripción	CAI	S mm	D mm	R' mm	Cdr. mm	Llanta recomendada	Llanta permitida	Cámara de aire (Código)	Volumen interno al 75% (litros)	Profundidad de la banda de rodamiento (mm)			
42	IF 900/60 R42 186D TL	111950	881	2123	952	6304	DW30B (A)			1230	65			
Bar	0.4 0.6 0.8 1.0 1.2 1.4 1.6 1.7 1.8 1.9 2.0 2.1 2.2 2.3 2.4													
Psi	6 9 12 15 17 20 23 25 26 28 29 30 32 33 35													
65 km/h		5000	5750	6500	7250	8000	8190	8375	8565	8750	8940	9125	9315	9500
65 km/h Dual	3210 3805 4400	5060	5720	6380	7040	7205	7370	7535	7700	7865	8030	8195	8360	

Ø Pulgadas	Descripción	CAI	S mm	D mm	R' mm	Cdr. mm	Llanta recomendada	Llanta permitida	Cámara de aire (Código)	Volumen interno al 75% (litros)	Profundidad de la banda de rodamiento (mm)			
42	IF 710/70 R42 179D TL	771752	742	2062	919	6115	DW25B (A)	DW23B MW25B (A)	802	870	63			
Bar	0.4 0.6 0.8 1.0 1.2 1.4 1.6 1.7 1.8 1.9 2.0 2.1 2.2 2.3 2.4													
Psi	6 9 12 15 17 20 23 25 26 28 29 30 32 33 35													
65 km/h		4250	4850	5450	6075	6700	6850	7000	7150	7300	7415	7525	7640	7750
65 km/h Dual	2640 3190 3740	4270	4800	5350	5900	6030	6160	6290	6420	6520	6620	6720	6820	

Ø Pulgadas	Descripción	CAI	S mm	D mm	R' mm	Cdr. mm	Llanta recomendada	Llanta permitida	Cámara de aire (Código)	Volumen interno al 75% (litros)	Profundidad de la banda de rodamiento (mm)
42	IF 710/75 R42 176D TL	037489	715	2161	954	6395	DW25B (A)		802	953	66
Bar	0.4 0.6 0.8 1.0 1.2 1.4 1.6 1.7 1.8 1.9 2.0 2.1 2.2 2.3 2.4										
Psi	6 9 12 15 17 20 23 25 26 28 29 30 32 33 35										
65 km/h		4515	5160	5810	6455	7100					
65 km/h Dual	2845 3415 3980	4550	5115	5685	6250						

Ø Pulgadas	Descripción	CAI	S mm	D mm	R' mm	Cdr. mm	Llanta recomendada	Llanta permitida	Cámara de aire (Código)	Volumen interno al 75% (litros)	Profundidad de la banda de rodamiento (mm)			
46	IF 750/75 R46 186D TL	487001	761	2287	1043	6819	DW25B (A)			1147	71			
Bar	0.4 0.6 0.8 1.0 1.2 1.4 1.6 1.7 1.8 1.9 2.0 2.1 2.2 2.3 2.4													
Psi	6 9 12 15 17 20 23 25 26 28 29 30 32 33 35													
65 km/h		5150	5825	6500	7250	8000	8190	8375	8565	8750	8940	9125	9315	9500
65 km/h Dual	3210 3870 4530	5125	5720	6380	7040	7205	7370	7535	7700	7865	8030	8195	8360	

***IMPORTANTE:**

La presión de inflado se determina siempre en función de la carga por neumático, de la velocidad y del trabajo a realizar. Las recomendaciones anteriores se facilitan con la salvedad de modificaciones posteriores a la fecha de difusión de estas tablas (junio de 2018). Los datos técnicos pueden sufrir modificaciones sin previo aviso.

- Cuando se usa la configuración de montaje único:
 - Añadir 0.4 Bar para usar en pendientes superiores al 20%
 - Añadir 0.4 Bar para uso pesado en carreteras superiores al 50%



MICHELIN® MACHXBIB

**VALOR Y VERSATILIDAD
GARANTIZADOS PARA
TRACTORES DE ALTA
POTENCIA**



Para tractores de alta potencia de **160 HP y más**



VERSÁTIL, ideal para el transporte en carretera y eficiente en el campo:

- Velocidad de hasta 65 km/h⁽¹⁾
- Capacidad de carga en el campo
- Resistencia al daño



4% de AHORROS en COMBUSTIBLE, es decir, 1 litro/h, en comparación con la oferta de la competencia principal del mercado⁽²⁾ (para un consumo en carretera de 25 l/h)



Robustez del casco demostrada

(1) Cuando lo autorice la legislación vigente del país (según las dimensiones).

(2) Prueba analítica realizada en las pistas MICHELIN® del Centro de Pruebas e Investigación MICHELIN Ladoux.

DIMENSIONES

620/70 R26 153A8/150B TL XM27
 600/65 R28 154D/150E TL **NUEVO**
 600/70 R28 157D/154E TL **NUEVO**
 600/65 R28 154A8/154B TL
 600/65 R28 154D TL
 600/70 R28 157A8/157B TL
 600/70 R28 157D TL
 600/70 R30 158D TL **NUEVO**

600/70 R30 TL 152D
 710/55 R30 153D TL
 680/75 R32 164A8/161B TL XM28
 650/60 R34 159D/155E TL
 650/65 R34 161D/157E TL
 710/70 R38 171A8/171B TL
 650/75 R38 169A8/169B TL
 650/85 R38 173A8/173B TL

710/70 R38 171D TL
 800/70 R38 173D TL
 900/50 R42 168D TL
 710/70 R42 173D TL
 710/75 R42 175D/171E TL
 620/70 R46 162D TL **NUEVO**
 620/70 R46 162A8/162B TL XM28

MICHELIN® MACHXBIB

Características y presiones en (Bar) y (Psi): carga por neumático en kg*

Ø Pulgadas	Descripción	CAI	S mm	D mm	R' mm	Cdr. mm	Llanta recomendada	Llanta permitida	Cámara de aire (Código)	Volumen interno al 75% (litros)	Profundidad de la banda de rodamiento (mm)
26	620/70 R26 153A8/150B TL XM27	123880	629	1500	643	4469	DW20B (A)	DW18L	717 830	467	45
Bar	0.4 0.6 0.8 1.0 1.2 1.4 1.6 1.7 1.8 1.9 2.0 2.2 2.4 2.6 2.8										
Psi	6 9 12 15 17 20 23 25 26 28 29 32 35 38 41										
10 km/h**	2980 3365 3750 4135 4520 4905 5095 5290 5480										
30 km/h	2345 2660 2970 3285 3595 3910										
40 km/h	2370 2625 2880 3140 3395 3650										
50 km/h	2210 2440 2665 2895 3120 3350										

Ø Pulgadas	Descripción	CAI	S mm	D mm	R' mm	Cdr. mm	Llanta recomendada	Llanta permitida	Cámara de aire (Código)	Volumen interno al 75% (litros)	Profundidad de la banda de rodamiento (mm)
28	600/65R28 154D/150E TL NUEVO	429970	626	1494	671	4465	DW20B (A)	DW18L W18L DW21B(A)	717	405	54
Bar	0.4 0.6 0.8 1 1.2 1.4 1.6 1.7 1.8 1.9 2 2.2 2.4 2.6 2.8										
Psi	6 9 12 15 17 20 23 25 26 28 29 32 35 38 41										
10 km/h**	2250 2530 2810 3090 3445 3805 4160 4340 4520 4695 4875 5065 5250 5440 5625										
30 km/h	1725 2040 2360 2675 2990 3310 3625 3710 3800 3885 3970 4145 4315										
40 km/h	1915 2220 2530 2835 3145 3450 3530 3615 3695 3780 3940 4105										
40 km/h Dual	1445 1710 1975 2240 2505 2770 3035 3110 3180 3255 3325 3470 3615										
50 km/h	1840 2135 2430 2720 3015 3310 3390 3470 3545 3625 3785 3940										
65 km/h	2060 2335 2605 2880 3150 3225 3300 3375 3450 3600 3750										

Ø Pulgadas	Descripción	CAI	S mm	D mm	R' mm	Cdr. mm	Llanta recomendada	Llanta permitida	Cámara de aire (Código)	Volumen interno al 75% (litros)	Profundidad de la banda de rodamiento (mm)
28	600/70R28 157D/154E TL NUEVO	211033	629	1571	703	4652	DW20B (A)	DW18L DW21B(A)	717	448	54
Bar	0.4 0.6 0.8 1 1.2 1.4 1.6 1.7 1.8 1.9 2 2.2 2.4 2.6 2.8										
Psi	6 9 12 15 17 20 23 25 26 28 29 32 35 38 41										
10 km/h**	2475 2800 3125 3450 3855 4260 4665 4870 5070 5275 5475 5655 5835 6010 6190										
30 km/h	1900 2265 2630 2995 3355 3720 4085 4170 4250 4335 4415 4580 4745										
40 km/h	2135 2485 2835 3185 3535 3885 3965 4045 4120 4200 4360 4515										
40 km/h Dual	1590 1895 2200 2505 2810 3115 3420 3490 3560 3630 3700 3835 3975										
50 km/h	2050 2385 2720 3060 3395 3730 3805 3880 3955 4030 4180 4330										
65 km/h	2300 2615 2925 3240 3550 3620 3695 3765 3840 3980 4125										

* Consultar las notas al final de las tablas de esta gama.

MICHELIN® MACHXBIB

Características y presiones en (Bar) y (Psi): carga por neumático en kg*

Ø Pulgadas	Descripción	CAI	S mm	D mm	R' mm	Cdr. mm	Llanta recomendada	Llanta permitida	Cámara de aire (Código)	Volumen interno al 75% (litros)	Profundidad de la banda de rodamiento (mm)				
28	600/65 R28 154A8/154B TL	135288	615	1485	669	4415	DW20B (A)	DW18L, W18L	717	425	55				
Bar	0.4 0.6 0.8 1.0 1.2 1.4 1.6 1.7 1.8 1.9 2.0 2.1 2.2 2.3 2.4														
Psi	6 9 12 15 17 20 23 25 26 28 29 30 32 33 35														
40 km/h Dual	1320 1610 1900	2190	2385	2575	2770	2835	2905	2970	3035	3100	3170	3235	3300		
10 km/h**		3150	3505	3855	4210	4390	4565	4745	4920	5100	5275	5455	5630		
25 km/h		2610	2925	3245	3560	3635	3710	3785	3860	3935	4010	4085	4160		
30 km/h	1610 1915 2215	2520	2825	3125	3430	3505	3575	3650	3720	3795	3865	3940	4010		
40 km/h		2490	2710	2930	3150	3225	3300	3375	3450	3525	3600	3675	3750		
50 km/h			2710	2930	3150	3225	3300	3375	3450	3525	3600	3675	3750		

Ø Pulgadas	Descripción	CAI	S mm	D mm	R' mm	Cdr. mm	Llanta recomendada	Llanta permitida	Cámara de aire (Código)	Volumen interno al 75% (litros)	Profundidad de la banda de rodamiento (mm)				
28	600/65 R28 154D TL	055335	615	1502	666	4449	DW20B (A)	DW18L W18L	717	425	51				
Bar	0.4 0.6 0.8 1.0 1.2 1.4 1.6 1.7 1.8 1.9 2.0 2.2 2.4 2.6 2.8														
Psi	6 9 12 15 17 20 23 25 26 28 29 32 35 38 41														
10 km/h**	2250 2605 2960	3315	3660	4005	4350	4455	4565	4670	4775	4990	5205	5415	5630		
30 km/h	1690 2010 2335	2655	2975	3300	3620	3705	3795	3880	3965	4140	4310				
40 km/h															
40 km/h	1915 2250	2580	2870	3160	3450	3530	3615	3695	3780	3940	4105				
50 km/h	1840 2155	2465	2780	3045	3305	3385	3465	3545	3625	3780	3940				
65 km/h		2360	2625	2885	3150	3225	3300	3375	3450	3600	3750				
40 km/h Dual	1415 1700 1985	2270	2525	2780	3035	3110	3180	3255	3325	3470	3615				

Ø Pulgadas	Descripción	CAI	S mm	D mm	R' mm	Cdr. mm	Llanta recomendada	Llanta permitida	Cámara de aire (Código)	Volumen interno al 75% (litros)	Profundidad de la banda de rodamiento (mm)				
28	600/70 R28 157D TL	438598	614	1572	701	4663	DW20B (A)	DW18L	717	495	52				
Bar	0.4 0.6 0.8 1.0 1.2 1.4 1.6 1.7 1.8 1.9 2.0 2.2 2.4 2.6 2.8														
Psi	6 9 12 15 17 20 23 25 26 28 29 32 35 38 41														
10 km/h**	2475 2860 3245	3630	4045	4460	4875	5025	5175	5325	5475	5655	5835	6010	6190		
30 km/h	1860 2230 2600	2970	3340	3710	4080	4165	4245	4330	4415	4580	4745				
40 km/h															
40 km/h	2135 2480	2825	3180	3530	3885	3965	4045	4120	4200	4360	4515				
50 km/h	2050 2380	2715	3045	3385	3725	3800	3875	3950	4030	4180	4330				
65 km/h		2580	2905	3225	3550	3620	3695	3765	3840	3980	4125				
40 km/h Dual	1560 1870 2180	2490	2800	3110	3420	3490	3560	3630	3700	3835	3975				

* Consultar las notas al final de las tablas de esta gama.

MICHELIN® MACHXBIB

Características y presiones en (Bar) y (Psi): carga por neumático en kg*

Ø Pulgadas	Descripción	CAI	S mm	D mm	R' mm	Cdr. mm	Llanta recomendada	Llanta permitida	Cámara de aire (Código)	Volumen interno al 75% (litros)	Profundidad de la banda de rodamiento (mm)
28	600/70 R28 157A8/157B TL	395016	623	1586	701	4694	DW20B (A)	DW18L	717	495	53
Bar	0.4 0.6 0.8 1.0 1.2 1.4 1.6 1.7 1.8 1.9 2.0 2.1 2.2 2.3 2.4										
Psi	6 9 12 15 17 20 23 25 26 28 29 30 32 33 35										
40 km/h Dual	1435 1795 2150 2510	2815 3125 3430 3455 3480 3505 3535 3560	3585 3610 3635								
10 km/h**		3470 3855 4245 4630 4825 5020 5215 5410 5605 5800 5995 6190									
30 km/h	1770 2160 2560	2955 3355 3750 4150 4185 4215 4250 4280 4315 4345 4380 4410									
40 km/h		2850 3200 3550 3900 3930 3960 3985 4015 4045 4075 4100 4130									
50 km/h		3200 3550 3900 3930 3960 3985 4015 4045 4075 4100 4130									

Ø Pulgadas	Descripción	CAI	S mm	D mm	R' mm	Cdr. mm	Llanta recomendada	Llanta permitida	Cámara de aire (Código)	Volumen interno al 75% (litros)	Profundidad de la banda de rodamiento (mm)
30	600/70R30 158D TL NUEVO	566557	638	1604	717	4760	DW20B (A)	DW18L DW21B (A)	737	468	56
Bar	0.4 0.6 0.8 1 1.2 1.4 1.6 1.7 1.8 1.9 2 2.2 2.4 2.6 2.8										
Psi	6 9 12 15 17 20 23 25 26 28 29 32 35 38 41										
10 km/h**	2475 2830 3185 3540	3955 4375 4790 5000 5210 5415 5625 5815 6000 6190 6375									
30 km/h	1900 2285 2665 3050	3435 3815 4200 4285 4375 4460 4545 4720 4890									
40 km/h		2190 2550 2910 3275 3635 3995 4080 4160 4245 4325 4490 4655									
40 km/h Dual	1590 1910 2230 2555	2875 3195 3515 3590 3660 3735 3805 3950 4095									
50 km/h		2100 2445 2795 3140 3490 3835 3915 3995 4070 4150 4310 4465									
65 km/h		2360 2685 3005 3325 3650 3725 3800 3875 3950 4100 4250									

Ø Pulgadas	Descripción	CAI	S mm	D mm	R' mm	Cdr. mm	Llanta recomendada	Llanta permitida	Cámara de aire (Código)	Volumen interno al 75% (litros)	Profundidad de la banda de rodamiento (mm)
30	710/55 R30 153D TL	992342	678	1518	668	4489	DW23B (A)			506	50
Bar	0.4 0.6 0.8 1.0 1.2 1.4 1.6 1.7 1.8 1.9 2.0 2.2 2.4 2.6 2.8										
Psi	6 9 12 15 17 20 23 25 26 28 29 32 35 38 41										
10 km/h**	2475 2960 3370 3775	4185 4590 5000 5160 5320 5480									
30 km/h	1900 2270 2655 3040	3430 3815 4200									
40 km/h		2165 2530 2900 3265 3635 4000									
50 km/h		2075 2425 2775 3130 3480 3830									
65 km/h		2300 2650 2985 3315 3650									
40 km/h Dual	1590 1905 2225 2550	2870 3195 3515									

* Consultar las notas al final de las tablas de esta gama.

MICHELIN® MACHXBIB

Características y presiones en (Bar) y (Psi): carga por neumático en kg*

Ø Pulgadas	Descripción	CAI	S mm	D mm	R' mm	Cdr. mm	Llanta recomendada	Llanta permitida	Cámara de aire (Código)	Volumen interno al 75% (litros)	Profundidad de la banda de rodamiento (mm)				
30	600/70 R30 TL 152D	334318	613	1605	706	4745	DW20B (A)	DW18L	737	456	56				
Bar	0.4 0.6 0.8 1.0 1.2 1.4 1.6 1.7 1.8 1.9 2.0 2.2 2.4 2.6 2.8														
Psi	6 9 12 15 17 20 23 25 26 28 29 32 35 38 41														
10 km/h**	2500 3000 3250 3750	4175	4600	5025	5125	5230	5330								
30 km/h	1915 2300 2680 3060	3440	3820	4200											
40 km/h	2190 2550 2910	3275	3635	3995											
50 km/h	2100 2445 2790	3140	3485	3830											
65 km/h	2335 2665 2960	3255	3550												
40 km/h Dual	1605 1930 2250 2565	2885	3200	3520											

Ø Pulgadas	Descripción	CAI	S mm	D mm	R' mm	Cdr. mm	Llanta recomendada	Llanta permitida	Cámara de aire (Código)	Volumen interno al 75% (litros)	Profundidad de la banda de rodamiento (mm)				
32	680/75 R32 164A8/161B TL XM28	123582	675	1865	819	5512	DW21B (A)	DW20B (A)	831	743	58				
Bar	0.4 0.6 0.8 1.0 1.2 1.4 1.6 1.7 1.8 1.9 2.0 2.2 2.4 2.6 2.8														
Psi	6 9 12 15 17 20 23 25 26 28 29 32 35 38 41														
10 km/h**	3230 4430 4900 5375	5845	6320	6790	7030	7265	7500								
30 km/h	2510 3480 3855 4230	4600	4975	5350											
40 km/h	3250 3600 3950	4300	4650	5000											
50 km/h	3050 3365 3680	4000	4315	4630											
40 km/h Dual	1970 2860 3170 3475	3785	4090	4400											

Ø Pulgadas	Descripción	CAI	S mm	D mm	R' mm	Cdr. mm	Llanta recomendada	Llanta permitida	Cámara de aire (Código)	Volumen interno al 75% (litros)	Profundidad de la banda de rodamiento (mm)				
34	650/60 R34 159D/155E TL	549996	655	1663	750	4944	DW21B (A)	DW20B (A) DW23B (A)	823	500	58				
Bar	0.4 0.6 0.8 1.0 1.2 1.4 1.6 1.7 1.8 1.9 2.0 2.2 2.4 2.6 2.8														
Psi	6 9 12 15 17 20 23 25 26 28 29 32 35 38 41														
10 km/h**	2475 2800 3125 3450	3885	4320	4755	4975	5190	5410	5625	5860	6095	6330	6565			
30 km/h	1900 2285 2665 3050	3435	3815	4200	4305	4410	4510	4615	4825	5030					
40 km/h	2190 2550 2910	3275	3635	3995	4095	4195	4295	4395	4590	4790					
50 km/h	2100 2445 2795	3140	3490	3835	3930	4025	4120	4215	4405	4595					
65 km/h	2300 2640 2975	3310	3650	3740	3830	3920	4015	4195	4375						
70 km/h	2095 2400 2710	3015	3320	3390	3460	3530	3600	3735	3875						
40 km/h Dual	1590 1910 2230 2555	2875	3195	3515	3605	3690	3780	3865	4040	4215					

* Consultar las notas al final de las tablas de esta gama.

MICHELIN® MACHXBIB

Características y presiones en (Bar) y (Psi): carga por neumático en kg*

Ø Pulgadas	Descripción	CAI	S mm	D mm	R' mm	Cdr. mm	Llanta recomendada	Llanta permitida	Cámara de aire (Código)	Volumen interno al 75% (litros)	Profundidad de la banda de rodamiento (mm)				
34	650/65 R34 161D/157E TL	817386	657	1723	779	5125	DW21B (A)	DW20B (A) DW23B (A)	823	555	58				
Bar	0.4	0.6	0.8	1.0	1.2	1.4	1.6	1.7	1.8	1.9	2.0	2.2	2.4	2.6	2.8
Psi	6	9	12	15	17	20	23	25	26	28	29	32	35	38	41
10 km/h**	2700	3090	3475	3865	4290	4720	5145	5360	5575	5785	6000	6235	6470	6705	6940
30 km/h	2070	2470	2865	3265	3660	4055	4455	4565	4670	4780	4890	5105	5320		
40 km/h		2385	2755	3130	3500	3875	4245	4350	4450	4555	4655	4860	5065		
50 km/h		2290	2645	3000	3360	3715	4070	4170	4265	4365	4465	4660	4855		
65 km/h			2575	2900	3225	3550	3875	3970	4065	4155	4250	4440	4625		
70 km/h			2345	2640	2935	3230	3525	3600	3675	3750	3825	3975	4125		
40 km/h Dual	1735	2070	2400	2735	3070	3400	3735	3825	3915	4005	4095	4275	4455		

Ø Pulgadas	Descripción	CAI	S mm	D mm	R' mm	Cdr. mm	Llanta recomendada	Llanta permitida	Cámara de aire (Código)	Volumen interno al 75% (litros)	Profundidad de la banda de rodamiento (mm)				
38	710/70 R38 171A8/171B TL	089862-A	713	1950	877	5794	DW23B (A)	DW25B (A), MW23B (A), MW25B (A)	804	815	63				
Bar	0.4	0.6	0.8	1.0	1.2	1.4	1.6	1.7	1.9	2.1	2.3	2.4	2.6	2.7	2.8
Psi	6	9	12	15	17	20	23	25	28	30	33	35	38	39	41
40 km/h Dual	2140	2560	2980	3400	3820	4240	4660	4755	4940	5130	5315	5410			
10 km/h**	2600	3185	3765	4350	5070	5790	6510	6870	7590	8110	8430	8590	8910	9070	9230
30 km/h	2600	3110	3625	4135	4645	5160	5670	5785	6010	6240	6465	6580			
40 km/h		2900	3385	3865	4345	4820	5300	5405	5620	5830	6045	6150			
50 km/h		2900	3385	3865	4345	4820	5300	5405	5620	5830	6045	6150			

Ø Pulgadas	Descripción	CAI	S mm	D mm	R' mm	Cdr. mm	Llanta recomendada	Llanta permitida	Cámara de aire (Código)	Volumen interno al 75% (litros)	Profundidad de la banda de rodamiento (mm)				
38	800/70 R38 173D TL	887730	809	2066	899	6093	DW25B (A)	DW27B (A) MW25B (A)		1071	61				
Bar	0.4	0.6	0.8	1.0	1.2	1.4	1.6	1.7	1.8	1.9	2.0	2.2	2.4	2.6	2.8
Psi	6	9	12	15	17	20	23	25	26	28	29	32	35	38	41
10 km/h Cyc Dual				5260	6155	7045	7940	8390	8835	9280	9725				
10 km/h**	4400	5115	5825	6540	7255	7965	8680	9035	9395	9750					
30 km/h	3375	4060	4740	5425	6110	6790	7475								
40 km/h		3860	4510	5165	5815	6470	7120								
50 km/h		3700	4325	4950	5575	6200	6825								
65 km/h			4115	4710	5305	5905	6500								
40 km/h Dual	2825	3400	3970	4545	5115	5690	6260								

* Consultar las notas al final de las tablas de esta gama.

MICHELIN® MACHXBIB

Características y presiones en (Bar) y (Psi): carga por neumático en kg*

Ø Pulgadas	Descripción	CAI	S mm	D mm	R' mm	Cdr. mm	Llanta recomendada	Llanta permitida	Cámara de aire (Código)	Volumen interno al 75% (litros)	Profundidad de la banda de rodamiento (mm)
38	710/70 R38 171D TL	708197	713	1973	871	5804	DW23B (A)	DW25B (A) MW23B (A) MW25B (A)	804	811	62
Bar	0.4 0.6 0.8 1.0 1.2 1.4 1.6 1.7 1.8 1.9 2.0 2.2 2.4 2.6 2.8										
Psi	6 9 12 15 17 20 23 25 26 28 29 32 35 38 41										
10 km/h**	3640 4250 4860 5470 6010 6550 7095 7365 7635 7905 8175 8440 8700 8965 9225										
30 km/h	2790 3340 3890 4445 4995 5545 6095 6215 6340 6460 6585 6825 7070										
40 km/h	3190 3725 4255 4770 5290 5805 5920 6040 6155 6270 6505 6735										
50 km/h	3060 3570 4080 4575 5070 5565 5675 5790 5900 6010 6235 6455										
65 km/h	3350 3840 4325 4815 5300 5405 5515 5620 5725 5940 6150										
40 km/h Dual	2340 2800 3260 3725 4185 4645 5105 5210 5310 5415 5515 5720 5925										

Ø Pulgadas	Descripción	CAI	S mm	D mm	R' mm	Cdr. mm	Llanta recomendada	Llanta permitida	Cámara de aire (Código)	Volumen interno al 75% (litros)	Profundidad de la banda de rodamiento (mm)
38	650/75 R38 169A8/169B TL	219467	664	1948	880	5761	DW23B (A)	MW23B (A)	804	731	61
Bar	0.4 0.6 0.8 1.0 1.2 1.4 1.6 1.7 1.8 1.9 2.0 2.2 2.4 2.6 2.8										
Psi	6 9 12 15 17 20 23 25 26 28 29 32 35 38 41										
10 km/h**	3360 4150 4940 5730 6050 6370 6690 6860 7025 7195 7360 7695 8030 8365 8700										
30 km/h	2410 3075 3745 4410 4680 4950 5220 5345 5470 5590 5715 5965 6210										
40 km/h	2725 3435 4140 4385 4630 4875 4990 5105 5220 5340 5570 5800										
50 km/h	2725 3435 4140 4385 4630 4875 4990 5105 5220 5340 5570 5800										
40 km/h Dual	1965 2525 3085 3645 3860 4075 4290 4390 4495 4595 4700 4900 5105										

Ø Pulgadas	Descripción	CAI	S mm	D mm	R' mm	Cdr. mm	Llanta recomendada	Llanta permitida	Cámara de aire (Código)	Volumen interno al 75% (litros)	Profundidad de la banda de rodamiento (mm)
38	650/85 R38 173A8/173B TL	118628	686	2063	924	6092	DW23B (A)	DW20B (A) MW23B (A)	804	860	64
Bar	0.4 0.6 0.8 1.0 1.2 1.4 1.6 1.7 1.8 1.9 2.0 2.2 2.4 2.6 2.8										
Psi	6 9 12 15 17 20 23 25 26 28 29 32 35 38 41										
10 km/h Cyc Dual	6400 6760 7120 7480 7665 7855 8040 8230 8605 8975 9350 9725										
10 km/h**	3750 4640 5530 6420 6780 7140 7500 7690 7875 8065 8250 8625 9000 9375 9750										
30 km/h	2700 3445 4195 4940 5245 5545 5850 5990 6125 6265 6405 6680 6955										
40 km/h	3000 3820 4640 4910 5180 5450 5580 5715 5845 5975 6240 6500										
50 km/h	3000 3820 4640 4910 5180 5450 5580 5715 5845 5975 6240 6500										
40 km/h Dual	2200 2830 3455 4085 4320 4560 4795 4910 5025 5140 5260 5490 5720										

* Consultar las notas al final de las tablas de esta gama.

MICHELIN® MACHXBIB

Características y presiones en (Bar) y (Psi): carga por neumático en kg*

Ø Pulgadas	Descripción	CAI	S mm	D mm	R' mm	Cdr. mm	Llanta recomendada	Llanta permitida	Cámara de aire (Código)	Volumen interno al 75% (litros)	Profundidad de la banda de rodamiento (mm)				
42	900/50 R42 168D TL	832458	853	1970	870	5826	DW27B (A)	DW28B (A) DW30B (A)		923	55				
Bar	0.4	0.6	0.8	1.0	1.2	1.4	1.6	1.7	1.8	1.9	2.0	2.2	2.4	2.6	2.8
Psi	6	9	12	15	17	20	23	25	26	28	29	32	35	38	41
10 km/h**	3825	4575	5195	5810	6430	7045	7665	7910	8155	8400					
30 km/h	2930	3510	4095	4680	5270	5855	6440								
40 km/h		3340	3900	4455	5015	5570	6130								
50 km/h		3200	3735	4270	4810	5345	5880								
65 km/h			3550	4090	4595	5095	5600								
40 km/h Dual	2455	2940	3430	3925	4415	4910	5400								

Ø Pulgadas	Descripción	CAI	S mm	D mm	R' mm	Cdr. mm	Llanta recomendada	Llanta permitida	Cámara de aire (Código)	Volumen interno al 75% (litros)	Profundidad de la banda de rodamiento (mm)				
42	710/75 R42 175D/171E TL	015540	693	2158	975	6424	DW23B (A)	DW25B (A)	802	867	61				
Bar	0.4	0.6	0.8	1.0	1.2	1.4	1.6	1.7	1.8	1.9	2.0	2.2	2.4	2.6	2.8
Psi	6	9	12	15	17	20	23	25	26	28	29	32	35	38	41
10 km/h**	3975	4775	5575	6375	7050	7725	8400	8740	9075	9415	9750	10125	10500	10875	11250
30 km/h	3050	3690	4335	4975	5615	6260	6900	7030	7160	7290	7420	7675	7935		
40 km/h		3560	4160	4765	5365	5970	6570	6695	6815	6940	7065	7310	7555		
50 km/h		3415	3990	4570	5145	5725	6300	6420	6535	6655	6775	7010	7245		
65 km/h			3750	4315	4875	5440	6000	6115	6225	6340	6450	6675	6900		
70 km/h			3415	3925	4440	4950	5460	5545	5635	5720	5805	5980	6150		
40 km/h Dual	2555	3095	3630	4170	4705	5245	5780	5890	6000	6105	6215	6435	6650		

Ø Pulgadas	Descripción	CAI	S mm	D mm	R' mm	Cdr. mm	Llanta recomendada	Llanta permitida	Cámara de aire (Código)	Volumen interno al 75% (litros)	Profundidad de la banda de rodamiento (mm)				
42	710/70 R42 173D TL	790388	721	2088	932	6195	DW23B (A)	DW25B (A) MW23B (A) MW25B (A)	802	872	64				
Bar	0.4	0.6	0.8	1.0	1.2	1.4	1.6	1.7	1.8	1.9	2.0	2.2	2.4	2.6	2.8
Psi	6	9	12	15	17	20	23	25	26	28	29	32	35	38	41
10 km/h Cyc Dual				4390	5190	5985	6785	7185	7580	7980	8380	8715	9050	9390	9725
10 km/h**	3750	4375	5000	5625	6210	6795	7380	7675	7965	8260	8550	8850	9150	9450	9750
30 km/h	2875	3470	4065	4660	5250	5845	6440	6570	6700	6830	6960	7215	7475		
40 km/h		3285	3835	4380	4965	5545	6130	6255	6380	6500	6625	6875	7120		
50 km/h		3150	3675	4200	4760	5320	5880	6000	6115	6235	6355	6590	6825		
65 km/h				4000	4535	5065	5600	5715	5825	5940	6050	6275	6500		
40 km/h Dual	2410	2910	3405	3905	4405	4900	5400	5510	5615	5725	5835	6050	6265		

* Consultar las notas al final de las tablas de esta gama.

MICHELIN® MACHXBIB

Características y presiones en (Bar) y (Psi): carga por neumático en kg*

Ø Pulgadas	Descripción	CAI	S mm	D mm	R' mm	Cdr. mm	Llanta recomendada	Llanta permitida	Cámara de aire (Código)	Volumen interno al 75% (litros)	Profundidad de la banda de rodamiento (mm)
46	620/70R46 162D TL NUEVO	131721	636	2042		6055	DW20B (A)	DW18L TW20B	834	698	
Bar	0.4	0.6	0.8	1	1.2	1.4	1.6	1.7	1.8	1.9	
Psi	6	9	12	15	17	20	23	25	26	28	
10 km/h**	3180	3705	4235	4760	5285	5815	6340	6600	6865	7125	
30 km/h	2440	2945	3450	3955	4460	4960	5465				
40 km/h		2820	3300	3775	4250	4725	5200				
40 km/h Dual	2045	2465	2890	3310	3730	4155	4575				
50 km/h		2705	3165	3620	4075	4535	4990				
65 km/h			3000	3440	3875	4315	4750				

Ø Pulgadas	Descripción	CAI	S mm	D mm	R' mm	Cdr. mm	Llanta recomendada	Llanta permitida	Cámara de aire (Código)	Volumen interno al 75% (litros)	Profundidad de la banda de rodamiento (mm)				
46	620/70 R46 162A8/162B TL XM28	122723	621	2061	926	6122	DW20B (A)		834	698	57				
Bar	0.4	0.6	0.8	1.0	1.2	1.4	1.6	1.7	1.8	1.9	2.0	2.2	2.4	2.6	2.8
Psi	6	9	12	15	17	20	23	25	26	28	29	32	35	38	41
10 km/h**	3060	4200	4650	5100	5550	6005	6455	6680	6905	7130					
30 km/h	2390	3300	3655	4010	4370	4725	5080								
40 km/h		3090	3420	3755	4085	4420	4750								
50 km/h		3090	3420	3755	4085	4420	4750								
40 km/h Dual	1865	2720	3010	3305	3595	3890	4180								

***IMPORTANTE:**

La presión de inflado se determina siempre en función de la carga por neumático, de la velocidad y del trabajo a realizar. Las recomendaciones anteriores se facilitan con la salvedad de modificaciones posteriores a la fecha de difusión de estas tablas (junio de 2018). Los datos técnicos pueden sufrir modificaciones sin previo aviso.

- Para arar y otras aplicaciones de campo sujetas a un alto torque, use la columna de 30 km/h.
 - Cuando se utiliza la configuración de montaje simple (single):
 - Añadir 0.4 Bar para usar en pendientes superiores al 20%
 - Añadir 0.4 Bar para uso pesado en carreteras superiores al 50%
- **10 km/h LT (torque bajo) (velocidad máxima 10 km/h).



MICHELIN® XEObib

**CUALQUIER DÍA DEL
AÑO, SOBRE CUALQUIER
SUPERFICIE, A MENOS
DE 15 PSI**



Para tractores de 80 a 220 HP

(Para cargas pesadas o un alto par motor, se aconseja el uso de MICHELIN® MACHXBIB / AXIOBIB / AXIOBIB 2)



Norma Very High Flexion (VF)



RENDIMIENTO

- + 4% / al año ⁽¹⁾
- Excelente **DURACIÓN**



AHORROS EN COMBUSTIBLE

- De hasta el 15% al trabajar en el campo ⁽²⁾



COMODIDAD

- Absorbe golpes e irregularidades del terreno

(1) Universidad de Harper Adams 2014/2016.

(2) Media comprobada en comparación con una dimensión estándar durante pruebas en el campo.

DIMENSIONES

VF 480/60 R28 134D TL
VF 520/60 R28 138D TL
VF 600/60 R28 146D TL
VF 600/60 R30 147D TL
VF 600/60 R34 149D TL
VF 600/60 R38 151D TL

VF 650/60 R38 155D TL
VF 710/60 R38 160D TL
VF 650/60 R42 157D TL **NUEVO**
VF 710/60 R42 161D TL

MICHELIN® XEOBIB

Características y presiones en (Bar) y (Psi): carga por neumático en kg*

Ø Pulgadas	Descripción	CAI	S mm	D mm	R' mm	Cdr. mm	Llanta recomendada	Llanta permitida	Cámara de aire (Código)	Volumen interno al 75% (litros)	Profundidad de la banda de rodamiento (mm)
28	VF 480/60 R28 134D TL	312875	488	1298	567	3831	DW16L	W16L	821	218	45
Bar	0.4	0.5	0.6	0.7	0.8	0.9	1.0	1.8			
Psi	6	7	9	10	12	13	15	26			
65 km/h	1320	1460	1600	1725	1850	1985	2120				
65 km/h Dual	1160	1285	1410	1520	1630	1750	1865				
10 km/h Fr Loader							3000				

Ø Pulgadas	Descripción	CAI	S mm	D mm	R' mm	Cdr. mm	Llanta recomendada	Llanta permitida	Cámara de aire (Código)	Volumen interno al 75% (litros)	Profundidad de la banda de rodamiento (mm)
28	VF 520/60 R28 138D TL	510495	534	1338	579	3942	DW18L	W18L	822	260	46
Bar	0.4	0.5	0.6	0.7	0.8	0.9	1.0	1.8			
Psi	6	7	9	10	12	13	15	26			
65 km/h	1500	1650	1800	1930	2060	2210	2360				
65 km/h Dual	1320	1455	1585	1700	1815	1945	2075				
10 km/h Fr Loader							3350				

Ø Pulgadas	Descripción	CAI	S mm	D mm	R' mm	Cdr. mm	Llanta recomendada	Llanta permitida	Cámara de aire (Código)	Volumen interno al 75% (litros)	Profundidad de la banda de rodamiento (mm)
28	VF 600/60 R28 146D TL	665184	597	1429	610	4198	DW20B (A)		822	365	48
Bar	0.4	0.5	0.6	0.7	0.8	0.9	1.0	1.8			
Psi	6	7	9	10	12	13	15	26			
65 km/h	1850	2045	2240	2445	2650	2825	3000				
65 km/h Dual	1630	1800	1970	2150	2330	2485	2640				
10 km/h Fr Loader							4250				

Ø Pulgadas	Descripción	CAI	S mm	D mm	R' mm	Cdr. mm	Llanta recomendada	Llanta permitida	Cámara de aire (Código)	Volumen interno al 75% (litros)	Profundidad de la banda de rodamiento (mm)
30	VF 600/60 R30 147D TL	065253	603	1493	633	4379	DW20B (A)		757	383	50
Bar	0.4	0.5	0.6	0.7	0.8	0.9	1.0	1.8			
Psi	6	7	9	10	12	13	15	26			
65 km/h	1950	2125	2300	2515	2725	2900	3075				
65 km/h Dual	1715	1870	2025	2215	2400	2555	2705				
10 km/h Fr Loader							4375				

* Consultar las notas al final de las tablas de esta gama.

MICHELIN® XEOBIB

Características y presiones en (Bar) y (Psi): carga por neumático en kg*

Ø Pulgadas	Descripción	CAI	S mm	D mm	R' mm	Cdr. mm	Llanta recomendada	Llanta permitida	Cámara de aire (Código)	Volumen interno al 75% (litros)	Profundidad de la banda de rodamiento (mm)
34	VF 600/60 R34 149D TL	664777	595	1595	690	4699	DW20B (A)		823	416	48
Bar	0.4	0.5	0.6	0.7	0.8	0.9	1.0	1.8			
Psi	6	7	9	10	12	13	15	26			
65 km/h	2060	2245	2430	2665	2900	3075	3250				
65 km/h Dual	1815	1980	2140	2345	2550	2705	2860				
10 km/h Fr Loader								4550			

Ø Pulgadas	Descripción	CAI	S mm	D mm	R' mm	Cdr. mm	Llanta recomendada	Llanta permitida	Cámara de aire (Código)	Volumen interno al 75% (litros)	Profundidad de la banda de rodamiento (mm)
38	VF 600/60 R38 151D TL	349257	549	1698	749	5023	DW20B (A)	MW20B (A)	824	452	52
Bar	0.4	0.5	0.6	0.7	0.8	0.9	1.0	1.8			
Psi	6	7	9	10	12	13	15	26			
65 km/h	2180	2380	2575	2790	3000	3225	3450				
65 km/h Dual	1920	2095	2265	2455	2640	2840	3035				

Ø Pulgadas	Descripción	CAI	S mm	D mm	R' mm	Cdr. mm	Llanta recomendada	Llanta permitida	Cámara de aire (Código)	Volumen interno al 75% (litros)	Profundidad de la banda de rodamiento (mm)
38	VF 650/60 R38 155D TL	454365	677	1735	749	5108	DW23B (A)	MW23B (A)	825	539	52
Bar	0.4	0.5	0.6	0.7	0.8	0.9	1.0	1.8			
Psi	6	7	9	10	12	13	15	26			
65 km/h	2430	2665	2900	3175	3450	3665	3875				
65 km/h Dual	2140	2345	2550	2795	3035	3225	3410				

Ø Pulgadas	Descripción	CAI	S mm	D mm	R' mm	Cdr. mm	Llanta recomendada	Llanta permitida	Cámara de aire (Código)	Volumen interno al 75% (litros)	Profundidad de la banda de rodamiento (mm)
38	VF 710/60 R38 160D TL	324138	712	1814	794	5356	DW25B (A)	MW25B (A)	825	665	54
Bar	0.4	0.5	0.6	0.7	0.8	0.9	1.0	1.8			
Psi	6	7	9	10	12	13	15	26			
65 km/h	2800	3075	3350	3615	3875	4190	4500				
65 km/h Dual	2465	2710	2950	3180	3410	3685	3960				

* Consultar las notas al final de las tablas de esta gama.

MICHELIN® XEOBIB

Características y presiones en (Bar) y (Psi): carga por neumático en kg*

Ø Pulgadas	Descripción	CAI	S mm	D mm	R' mm	Cdr. mm	Llanta recomendada	Llanta permitida	Cámara de aire (Código)	Volumen interno al 75% (litros)	Profundidad de la banda de rodamiento (mm)
42	VF 650/60 R42 157D TL NUEVO	220583	660	1840	810	5441	DW23B (A)	DW20B(A) (NRO)	802	645	58
Bar	0.4	0.5	0.6	0.7	0.8	0.9	1.0	1.8			
Psi	6	7	9	10	12	13	15	26			
10 km/h**	2835	3110	3385	3645	3905	4225	4540				
30 km/h	2625	2880	3135	3380	3620	3915	4210				
65 km/h	2575	2825	3075	3315	3550	3840	4125				
65 km/h Dual	2265	2485	2705	2915	3125	3380	3630				

Ø Pulgadas	Descripción	CAI	S mm	D mm	R' mm	Cdr. mm	Llanta recomendada	Llanta permitida	Cámara de aire (Código)	Volumen interno al 75% (litros)	Profundidad de la banda de rodamiento (mm)
42	VF 710/60 R42 161D TL	144294	716	1920	843	5675	DW25B (A)	MW25B (A)	802	713	57
Bar	0.4	0.5	0.6	0.7	0.8	0.9	1.0	1.8			
Psi	6	7	9	10	12	13	15	26			
65 km/h	2900	3175	3450	3790	4125	4375	4625				
65 km/h Dual	2550	2795	3035	3335	3630	3850	4070				

***IMPORTANTE:**

La presión de inflado se determina siempre en función de la carga por neumático, de la velocidad y del trabajo a realizar. Las recomendaciones anteriores se facilitan con la salvedad de modificaciones posteriores a la fecha de difusión de estas tablas (junio de 2018). Los datos técnicos pueden sufrir modificaciones sin previo aviso.

- Cuando se usa la configuración de montaje único:
 - Añadir 0.4 Bar para usar en pendientes superiores al 20%
 - Añadir 0.4 Bar para uso pesado en carreteras superiores al 50%
- 10 km/h Fr Cargador: aplicación con cargador frontal máx. velocidad de 10 km/h.
- **10 km/h LT (torque bajo) (velocidad máxima 10 km/h).



MICHELIN® MULTIBIB

MAYOR DURACIÓN PARA RENDIR MÁS KILÓMETROS



Para tractores de 80 a 220 HP

(Para cargas pesadas o un alto par motor, se aconseja el uso de MICHELIN® MACHXBIB / AXIOBIB / AXIOBIB 2)



VERSATILIDAD

- Gran funcionamiento en el campo y en la carretera



PRODUCTIVIDAD

- Alta TRACCIÓN para ahorrar tiempo y combustible
- Protección a los suelos
- Puede alcanzar velocidades de hasta 65 km/h⁽¹⁾



DURACIÓN

- La mayor profundidad de la banda de rodadura en comparación con 4 competidores principales⁽²⁾



COMODIDAD

- Excelente manejo en la carretera
- Mayor comodidad para el conductor durante el viaje



(1) Cuando la legislación vigente del país lo autorice.

(2) Para la dimensión 650/65 R42.

DIMENSIONES

320/65 R16 107D TL

320/65 R18 109A8/106B TL XM108

340/65 R18 113A8/110B TL XM108

420/65 R20 125A8/125B TL XM108

440/65 R20 128D TL

420/65 R24 126A8/126B TL XM108

440/65 R24 128D TL

480/65 R24 133D TL

540/65 R24 140D TL

420/65 R28 135D TL

440/65 R28 131D TL

480/65 R28 136D TL

540/65 R28 142D TL

540/65 R30 143D TL

540/65 R34 145D TL

540/65 R34 152D TL

600/65 R34 151D TL

540/65 R38 147D TL

600/65 R38 153D TL

650/65 R38 157D TL

650/65 R38 163D TL **NUEVO**

650/65 R42 158D TL

650/65 R42 165D TL **NUEVO**

MICHELIN® MULTIBIB

Características y presiones en (Bar) y (Psi): carga por neumático en kg*

Ø Pulgadas	Descripción	CAI	S mm	D mm	R' mm	Cdr. mm	Llanta recomendada	Llanta permitida	Cámara de aire (Código)	Volumen interno al 75% (litros)	Profundidad de la banda de rodamiento (mm)
16	320/65 R16 107D TL	494658	300	827	368	2452	W8	W10L W8L W9	827	65	29
Bar	0.4 0.5 0.6 0.8 1.0 1.2 1.4 1.6 1.8 1.9 2.0 2.2 2.4 2.7 2.8										
Psi	6 7 9 12 15 17 20 23 26 28 29 32 35 39 41										
10 km/h**	530 580 630 760 885 1015 1140 1270 1395 1460										
30 km/h	520 570 620 720 820 920 1025 1125										
40 km/h	530 580 680 775 875 975 1070										
50 km/h	510 555 650 745 840 935 1025										
65 km/h	490 535 625 710 800 890 975										

Ø Pulgadas	Descripción	CAI	S mm	D mm	R' mm	Cdr. mm	Llanta recomendada	Llanta permitida	Cámara de aire (Código)	Volumen interno al 75% (litros)	Profundidad de la banda de rodamiento (mm)
18	320/65 R18 109A8/106B TL XM108	123898	309	875	389	2594	W9	W10	444	64	28
Bar	0.4 0.5 0.6 0.8 1.0 1.2 1.4 1.6 1.8 1.9 2.0 2.2 2.4 2.7 2.8										
Psi	6 7 9 12 15 17 20 23 26 28 29 32 35 39 41										
10 km/h**	400 535 670 805 940 1075 1210 1345 1480 1550										
30 km/h	390 500 610 710 805 905 1000 1100										
40 km/h	460 570 665 755 850 940 1030										
50 km/h	430 520 605 690 780 865 950										

Ø Pulgadas	Descripción	CAI	S mm	D mm	R' mm	Cdr. mm	Llanta recomendada	Llanta permitida	Cámara de aire (Código)	Volumen interno al 75% (litros)	Profundidad de la banda de rodamiento (mm)
18	340/65 R18 113A8/110B TL XM108	123888	319	911	407	2719	W9	W10	444	76	29
Bar	0.4 0.5 0.6 0.8 1.0 1.2 1.4 1.6 1.8 1.9 2.0 2.2 2.4 2.7 2.8										
Psi	6 7 9 12 15 17 20 23 26 28 29 32 35 39 41										
10 km/h**	450 600 750 900 1050 1200 1355 1505 1655 1730										
30 km/h	440 560 680 790 900 1010 1120 1230										
40 km/h	520 630 735 840 945 1050 1150										
50 km/h	480 580 675 770 870 965 1060										

Ø Pulgadas	Descripción	CAI	S mm	D mm	R' mm	Cdr. mm	Llanta recomendada	Llanta permitida	Cámara de aire (Código)	Volumen interno al 75% (litros)	Profundidad de la banda de rodamiento (mm)
20	420/65 R20 125A8/125B TL XM108	122702	396	1064	461	3135	W11	W10 W12	664	140	36
Bar	0.4 0.5 0.6 0.8 1.0 1.2 1.4 1.6 1.8 1.9 2.0 2.2 2.4 2.7 2.8										
Psi	6 7 9 12 15 17 20 23 26 28 29 32 35 39 41										
10 km/h**	970 1140 1310 1525 1735 1950 2160 2375										
30 km/h	770 925 1080 1255 1425 1600 1770										
40 km/h	830 1010 1170 1330 1490 1650										
50 km/h	830 1010 1115 1225 1330 1435 1545 1650										

* Consultar las notas al final de las tablas de esta gama.

MICHELIN® MULTIBIB

Características y presiones en (Bar) y (Psi): carga por neumático en kg*

Ø Pulgadas	Descripción	CAI	S mm	D mm	R' mm	Cdr. mm	Llanta recomendada	Llanta permitida	Cámara de aire (Código)	Volumen interno al 75% (litros)	Profundidad de la banda de rodamiento (mm)
20	440/65 R20 128D TL	675464	445	1090	475	3260	W14L	W13 W15L	664	157	44
Bar	0.4 0.5 0.6 0.8 1.0 1.2 1.4 1.6 1.8 1.9 2.0 2.2 2.4 2.7 2.8										
Psi	6 7 9 12 15 17 20 23 26 28 29 32 35 39 41										
10 km/h**	1200 1295 1390 1570 1750 1930 2125 2315 2510 2605 2700										
30 km/h	920 1020 1120 1305 1485 1670 1870 2070										
40 km/h	1070 1245 1415 1590 1780 1970										
50 km/h	1025 1165 1310 1450 1670 1890										
65 km/h	975 1135 1290 1450 1625 1800										
40 km/h Dual	770 855 940 1095 1245 1400 1570 1735										

Ø Pulgadas	Descripción	CAI	S mm	D mm	R' mm	Cdr. mm	Llanta recomendada	Llanta permitida	Cámara de aire (Código)	Volumen interno al 75% (litros)	Profundidad de la banda de rodamiento (mm)
24	420/65 R24 126A8/126B TL XM108	122712	395	1160	507	3425	W11	W10W12	700	150	37
Bar	0.4 0.5 0.6 0.8 1.0 1.2 1.4 1.6 1.8 1.9 2.0 2.2 2.4 2.7 2.8										
Psi	6 7 9 12 15 17 20 23 26 28 29 32 35 39 41										
10 km/h**	990 1170 1350 1570 1785 2005 2225 2440										
30 km/h	790 950 1110 1290 1465 1645 1820										
40 km/h	850 1040 1205 1370 1535 1700										
50 km/h	850 1040 1150 1260 1370 1480 1590 1700										

Ø Pulgadas	Descripción	CAI	S mm	D mm	R' mm	Cdr. mm	Llanta recomendada	Llanta permitida	Cámara de aire (Código)	Volumen interno al 75% (litros)	Profundidad de la banda de rodamiento (mm)
24	440/65 R24 128D TL	426389	439	1187	529	3519	DW14L	DW13 DW15L W13 W14L W15L	703	178	44
Bar	0.4 0.5 0.6 0.8 1.0 1.2 1.4 1.6 1.8 1.9 2.0 2.2 2.4 2.7 2.8										
Psi	6 7 9 12 15 17 20 23 26 28 29 32 35 39 41										
10 km/h**	1285 1370 1450 1655 1855 2060 2225 2395 2560 2640 2725										
30 km/h	980 1080 1180 1380 1580 1780 1925 2070										
40 km/h	1130 1320 1510 1700 1835 1970										
50 km/h	1080 1265 1445 1630 1760 1890										
65 km/h	1030 1205 1375 1550 1675 1800										
40 km/h Dual	820 910 995 1160 1330 1495 1615 1735										

* Consultar las notas al final de las tablas de esta gama.

MICHELIN® MULTIBIB

Características y presiones en (Bar) y (Psi): carga por neumático en kg*

Ø Pulgadas	Descripción	CAI	S mm	D mm	R' mm	Cdr. mm	Llanta recomendada	Llanta permitida	Cámara de aire (Código)	Volumen interno al 75% (litros)	Profundidad de la banda de rodamiento (mm)				
24	480/65 R24 133D TL	531721	483	1240	546	3667	DW15L	DW14L W14L W15L	710	218	46				
Bar	0.4	0.5	0.6	0.8	1.0	1.2	1.4	1.6	1.8	1.9	2.0	2.2	2.4	2.7	2.8
Psi	6	7	9	12	15	17	20	23	26	28	29	32	35	39	41
10 km/h**	1450	1575	1700	1920	2140	2360	2560	2755	2955	3050	3150				
30 km/h	1120	1240	1360	1575	1795	2010	2190	2370							
40 km/h			1290	1500	1710	1920	2090	2260							
50 km/h			1240	1440	1640	1840	2000	2160							
65 km/h			1180	1370	1560	1750	1905	2060							
40 km/h Dual	940	1040	1135	1320	1505	1690	1840	1990							

Ø Pulgadas	Descripción	CAI	S mm	D mm	R' mm	Cdr. mm	Llanta recomendada	Llanta permitida	Cámara de aire (Código)	Volumen interno al 75% (litros)	Profundidad de la banda de rodamiento (mm)				
24	540/65 R24 140D TL	097057	532	1312	573	3873	DW16L	DW18L W16L W18L	710	287	48				
Bar	0.4	0.5	0.6	0.8	1.0	1.2	1.4	1.6	1.8	1.9	2.0	2.2	2.4	2.7	2.8
Psi	6	7	9	12	15	17	20	23	26	28	29	32	35	39	41
10 km/h**	1750	1875	2000	2265	2535	2800	3040	3275	3515	3630	3750				
30 km/h	1360	1485	1610	1885	2165	2440	2660	2880							
40 km/h			1530	1795	2055	2320	2530	2740							
50 km/h			1470	1725	1975	2230	2430	2630							
65 km/h			1400	1640	1880	2120	2310	2500							
40 km/h Dual	1140	1245	1345	1575	1810	2040	2225	2410							

Ø Pulgadas	Descripción	CAI	S mm	D mm	R' mm	Cdr. mm	Llanta recomendada	Llanta permitida	Cámara de aire (Código)	Volumen interno al 75% (litros)	Profundidad de la banda de rodamiento (mm)				
28	420/65 R28 135D TL	778211	390	1238	558	3680	W11	W12	732	177	44				
Bar	0.4	0.5	0.6	0.8	1.0	1.2	1.4	1.6	1.8	1.9	2.0	2.2	2.4	2.7	2.8
Psi	6	7	9	12	15	17	20	23	26	28	29	32	35	39	41
10 km/h**	1275	1410	1545	1710	1875	2040	2185	2325	2495	2580	2665	2830	3000	3205	3270
30 km/h	980	1085	1185	1355	1535	1715	1890	2070	2180	2235	2290	2395	2505		
40 km/h			1130	1290	1460	1630	1800	1970	2075	2125	2180	2280	2385		
50 km/h			1030	1240	1405	1565	1725	1890	1990	2040	2090	2190	2290		
65 km/h			1030	1180	1335	1490	1645	1800	1895	1945	1990	2085	2180		
40 km/h Dual	820	910	995	1160	1330	1495	1615	1735	1825	1870	1920	2010	2100	2230	2275

* Consultar las notas al final de las tablas de esta gama.

MICHELIN® MULTIBIB

Características y presiones en (Bar) y (Psi): carga por neumático en kg*

Ø Pulgadas	Descripción	CAI	S mm	D mm	R' mm	Cdr. mm	Llanta recomendada	Llanta permitida	Cámara de aire (Código)	Volumen interno al 75% (litros)	Profundidad de la banda de rodamiento (mm)				
28	440/65 R28 131D TL	386212	437	1291	579	3833	DW14L	DW15L W13 W14L W15L	821	198	43				
Bar	0.4	0.5	0.6	0.8	1.0	1.2	1.4	1.6	1.8	1.9	2.0	2.2	2.4	2.7	2.8
Psi	6	7	9	12	15	17	20	23	26	28	29	32	35	39	41
10 km/h**	1360	1480	1600	1795	1985	2180	2360	2540	2720	2810	2900				
30 km/h	1060	1155	1250	1465	1685	1900	2070	2240							
40 km/h			1190	1395	1605	1810	1975	2140							
50 km/h			1140	1335	1535	1730	1890	2050							
65 km/h			1090	1275	1465	1650	1800	1950							
40 km/h Dual	890	970	1045	1230	1410	1595	1740	1885							

Ø Pulgadas	Descripción	CAI	S mm	D mm	R' mm	Cdr. mm	Llanta recomendada	Llanta permitida	Cámara de aire (Código)	Volumen interno al 75% (litros)	Profundidad de la banda de rodamiento (mm)				
28	480/65 R28 136D TL	897574	476	1339	596	3970	DW15L	DW14L W14L W15L	822	242	45				
Bar	0.4	0.5	0.6	0.8	1.0	1.2	1.4	1.6	1.8	1.9	2.0	2.2	2.4	2.7	2.8
Psi	6	7	9	12	15	17	20	23	26	28	29	32	35	39	41
10 km/h**	1550	1675	1800	2035	2265	2500	2715	2925	3140	3245	3350				
30 km/h	1180	1310	1440	1690	1940	2190	2385	2580							
40 km/h			1370	1605	1845	2080	2265	2450							
50 km/h			1310	1540	1770	2000	2175	2350							
65 km/h			1250	1465	1685	1900	2070	2240							
40 km/h Dual	990	1100	1205	1415	1620	1830	1995	2155							

Ø Pulgadas	Descripción	CAI	S mm	D mm	R' mm	Cdr. mm	Llanta recomendada	Llanta permitida	Cámara de aire (Código)	Volumen interno al 75% (litros)	Profundidad de la banda de rodamiento (mm)				
28	540/65 R28 142D TL	792274	529	1427	630	4223	DW16L	DW18L W16L W18L	822	318	48				
Bar	0.4	0.5	0.6	0.8	1.0	1.2	1.4	1.6	1.8	1.9	2.0	2.2	2.4	2.7	2.8
Psi	6	7	9	12	15	17	20	23	26	28	29	32	35	39	41
10 km/h**	1900	2040	2180	2455	2725	3000	3250	3500	3750	3875	4000				
30 km/h	1440	1585	1730	2015	2295	2580	2815	3050							
40 km/h			1640	1910	2180	2450	2675	2900							
50 km/h			1580	1835	2095	2350	2565	2780							
65 km/h			1500	1745	1995	2240	2445	2650							
40 km/h Dual	1205	1325	1445	1680	1920	2155	2355	2550							

* Consultar las notas al final de las tablas de esta gama.

MICHELIN® MULTIBIB

Características y presiones en (Bar) y (Psi): carga por neumático en kg*

Ø Pulgadas	Descripción	CAI	S mm	D mm	R' mm	Cdr. mm	Llanta recomendada	Llanta permitida	Cámara de aire (Código)	Volumen interno al 75% (litros)	Profundidad de la banda de rodamiento (mm)
30	540/65 R30 143D TL	223153	527	1472	648	4353	DW16L	DW18L W16L W18L	754	333	48
Bar	0.4 0.5 0.6 0.8 1.0 1.2 1.4 1.6 1.8 1.9 2.0 2.2 2.4 2.7 2.8										
Psi	6 7 9 12 15 17 20 23 26 28 29 32 35 39 41										
10 km/h**	1950 2095 2240 2520 2795 3075 3340 3600 3865 3995 4125										
30 km/h	1480 1630 1780 2070 2360 2650 2890 3130										
40 km/h	1700 1975 2245 2520 2750 2980										
50 km/h	1630 1895 2155 2420 2640 2860										
65 km/h	1550 1800 2050 2300 2515 2725										
40 km/h Dual	1240 1370 1495 1735 1980 2220 2420 2620										

Ø Pulgadas	Descripción	CAI	S mm	D mm	R' mm	Cdr. mm	Llanta recomendada	Llanta permitida	Cámara de aire (Código)	Volumen interno al 75% (litros)	Profundidad de la banda de rodamiento (mm)
34	540/65 R34 145D TL	712064	530	1574	693	4655	DW16L	DW18L W16L W18L	704	364	48
Bar	0.4 0.5 0.6 0.8 1.0 1.2 1.4 1.6 1.8 1.9 2.0 2.2 2.4 2.7 2.8										
Psi	6 7 9 12 15 17 20 23 26 28 29 32 35 39 41										
10 km/h**	2060 2210 2360 2655 2955 3250 3530 3815 4095 4235 4375										
30 km/h	1560 1730 1900 2225 2555 2880 3110 3340										
40 km/h	1810 2120 2430 2740 2960 3180										
50 km/h	1730 2030 2330 2630 2840 3050										
65 km/h	1650 1935 2215 2500 2700 2900										
40 km/h Dual	1310 1455 1595 1865 2140 2410 2605 2800										

Ø Pulgadas	Descripción	CAI	S mm	D mm	R' mm	Cdr. mm	Llanta recomendada	Llanta permitida	Cámara de aire (Código)	Volumen interno al 75% (litros)	Profundidad de la banda de rodamiento (mm)
34	540/65 R34 152D TL	214036	530	1590	709	4716	DW16L	DW18L W16L W18L	704	364	48
Bar	0.4 0.5 0.6 0.8 1.0 1.2 1.4 1.6 1.8 1.9 2.0 2.2 2.4 2.7 2.8										
Psi	6 7 9 12 15 17 20 23 26 28 29 32 35 39 41										
10 km/h**	2060 2210 2360 2655 2955 3250 3530 3815 4095 4235 4375 4625 4875 5215 5325										
30 km/h	1560 1730 1900 2225 2555 2880 3110 3340 3525 3620 3710 3895 4080										
40 km/h	1810 2120 2430 2740 2960 3180 3360 3445 3535 3715 3890										
50 km/h	1730 2030 2330 2630 2840 3050 3220 3305 3390 3560 3730										
65 km/h	1650 1935 2215 2500 2700 2900 3065 3145 3225 3390 3550										
40 km/h Dual	1310 1455 1595 1865 2140 2410 2605 2800 2955 3035 3110 3265 3420										

* Consultar las notas al final de las tablas de esta gama.

MICHELIN® MULTIBIB

Características y presiones en (Bar) y (Psi): carga por neumático en kg*

Ø Pulgadas	Descripción	CAI	S mm	D mm	R' mm	Cdr. mm	Llanta recomendada	Llanta permitida	Cámara de aire (Código)	Volumen interno al 75% (litros)	Profundidad de la banda de rodamiento (mm)				
34	600/65 R34 151D TL	557189	594	1654	732	4897	DW20B (A)	DW18L W18L	823	464	54				
Bar	0.4	0.5	0.6	0.8	1.0	1.2	1.4	1.6	1.8	1.9	2.0	2.2	2.4	2.7	2.8
Psi	6	7	9	12	15	17	20	23	26	28	29	32	35	39	41
10 km/h**	2430	2615	2800	3160	3515	3875	4195	4515	4830	4990	5150				
30 km/h	1840	2040	2240	2605	2975	3340	3655	3970							
40 km/h			2140	2485	2835	3180	3480	3780							
50 km/h			2050	2385	2715	3050	3335	3620							
65 km/h			1950	2265	2585	2900	3175	3450							
40 km/h Dual	1540	1715	1885	2190	2495	2800	3065	3325							

Ø Pulgadas	Descripción	CAI	S mm	D mm	R' mm	Cdr. mm	Llanta recomendada	Llanta permitida	Cámara de aire (Código)	Volumen interno al 75% (litros)	Profundidad de la banda de rodamiento (mm)				
38	540/65 R38 147D TL	114518	529	1675	745	4965	DW16L	DW18L W16L W18L	824	394	48				
Bar	0.4	0.5	0.6	0.8	1.0	1.2	1.4	1.6	1.8	1.9	2.0	2.2	2.4	2.7	2.8
Psi	6	7	9	12	15	17	20	23	26	28	29	32	35	39	41
10 km/h**	2180	2340	2500	2815	3135	3450	3745	4040	4330	4480	4625				
30 km/h	1670	1840	2010	2325	2645	2960	3250	3540							
40 km/h			1920	2220	2520	2820	3095	3370							
50 km/h			1840	2125	2415	2700	2965	3230							
65 km/h			1750	2025	2300	2575	2825	3075							
40 km/h Dual	1400	1545	1690	1955	2215	2480	2725	2965							

Ø Pulgadas	Descripción	CAI	S mm	D mm	R' mm	Cdr. mm	Llanta recomendada	Llanta permitida	Cámara de aire (Código)	Volumen interno al 75% (litros)	Profundidad de la banda de rodamiento (mm)				
38	600/65 R38 153D TL	228045	595	1768	779	5229	DW20B (A)	DW18L W18L	825	500	53				
Bar	0.4	0.5	0.6	0.8	1.0	1.2	1.4	1.6	1.8	1.9	2.0	2.2	2.4	2.7	2.8
Psi	6	7	9	12	15	17	20	23	26	28	29	32	35	39	41
10 km/h**	2575	2775	2970	3355	3740	4125	4455	4790	5120	5285	5450				
30 km/h	1960	2165	2370	2760	3150	3540	3870	4200							
40 km/h			2260	2630	3000	3370	3685	4000							
50 km/h			2160	2515	2875	3230	3530	3830							
65 km/h			2060	2400	2735	3075	3365	3650							
40 km/h Dual	1645	1820	1990	2315	2640	2965	3245	3520							

* Consultar las notas al final de las tablas de esta gama.

MICHELIN® MULTIBIB

Características y presiones en (Bar) y (Psi): carga por neumático en kg*

Ø Pulgadas	Descripción	CAI	S mm	D mm	R' mm	Cdr. mm	Llanta recomendada	Llanta permitida	Cámara de aire (Código)	Volumen interno al 75% (litros)	Profundidad de la banda de rodamiento (mm)				
38	650/65 R38 157D TL	292904	646	1819	801	5380	DW20B (A)		825	602	56				
Bar	0.4	0.5	0.6	0.8	1.0	1.2	1.4	1.6	1.8	1.9	2.0	2.2	2.4	2.7	2.8
Psi	6	7	9	12	15	17	20	23	26	28	29	32	35	39	41
10 km/h**	2900	3125	3350	3775	4200	4625	5005	5390	5770	5960	6150				
30 km/h	2190	2420	2650	3090	3530	3970	4355	4740							
40 km/h			2520	2940	3360	3780	4150	4520							
50 km/h			2420	2820	3220	3620	3975	4330							
65 km/h			2300	2685	3065	3450	3790	4125							
40 km/h Dual	1835	2030	2220	2590	2955	3325	3655	3980							

Ø Pulgadas	Descripción	CAI	S mm	D mm	R' mm	Cdr. mm	Llanta recomendada	Llanta permitida	Cámara de aire (Código)	Volumen interno al 75% (litros)	Profundidad de la banda de rodamiento (mm)				
42	650/65 R42 158D TL	167733	638	1931	858	5722	DW20B (A)		802	647	57				
Bar	0.4	0.5	0.6	0.8	1.0	1.2	1.4	1.6	1.8	1.9	2.0	2.2	2.4	2.7	2.8
Psi	6	7	9	12	15	17	20	23	26	28	29	32	35	39	41
10 km/h**	3000	3225	3450	3885	4315	4750	5155	5565	5970	6170	6375				
30 km/h	2300	2545	2790	3260	3730	4200	4545	4890							
40 km/h			2660	3105	3555	4000	4325	4650							
50 km/h			2550	2975	3405	3830	4145	4460							
65 km/h			2430	2835	3245	3650	3950	4250							
40 km/h Dual	1930	2135	2340	2735	3125	3520	3805	4090							

***IMPORTANTE:**

La presión de inflado se determina siempre en función de la carga por neumático, de la velocidad y del trabajo a realizar. Las recomendaciones anteriores se facilitan con la salvedad de modificaciones posteriores a la fecha de difusión de estas tablas (junio de 2018). Los datos técnicos pueden sufrir modificaciones sin previo aviso.

- Para arar y otras aplicaciones de campo sujetas a un alto torque, use la columna de 30 km/h.
 - Cuando se utiliza la configuración de montaje simple (single):
 - Añadir 0.4 Bar para usar en pendientes superiores al 20%
 - Añadir 0.4 Bar para uso pesado en carreteras superiores al 50%
- **10 km/h LT (torque bajo) (velocidad máxima 10 km/h).



MICHELIN® OMNIBIB

**MÁXIMA VERSATILIDAD
PARA OPTIMIZAR SUS
GASTOS**



Para tractores de 70 a 180 HP

(Para cargas pesadas o un alto par motor, se aconseja el uso de MICHELIN® MACHXBIB / AXIOBIB / AXIOBIB 2)



VERSATILIDAD

- Diseño especial para soportar las cargas del trabajo con palas frontales
- Hasta un 14%⁽¹⁾ más de **capacidad de carga**
- Excelente **estabilidad y maniobrabilidad** para el trabajo en explotaciones ganaderas
- Gran capacidad de **tracción**



DURACIÓN

- Resistencia del casco demostrada
- Resistencia al daño

(1) Dependiendo de las dimensiones de los neumáticos y en comparación con la dimensión equivalente en MICHELIN® AGRIBIB.

DIMENSIONES

280/70 R16 112D TL
280/70 R20 116D TL
320/70 R24 116D TL
360/70 R24 122D TL
380/70 R24 125D TL
420/70 R24 130D TL

480/70 R24 138D TL
380/70 R28 127D TL
420/70 R28 133D TL
480/70 R28 140D TL
480/70 R30 141D TL
480/70 R34 143D TL

520/70 R34 148D TL
480/70 R38 145D TL
520/70 R38 150D TL
580/70 R38 155D TL
620/70 R42 160D TL

MICHELIN® OMNIBIB

Características y presiones en (Bar) y (Psi): carga por neumático en kg*

Ø Pulgadas	Descripción	CAI	S mm	D mm	R' mm	Cdr. mm	Llanta recomendada	Llanta permitida	Cámara de aire (Código)	Volumen interno al 75% (litros)	Profundidad de la banda de rodamiento (mm)
16	280/70 R16 112D TL	747196	276	805	360	2400	W9	W10L W8 W8L	184	45	29
Bar	0.4 0.5 0.6 0.7 0.8 0.9 1.0 1.2 1.4 1.5 1.6 1.7 1.8 1.9 2.0										
Psi	6 7 9 10 12 13 15 17 20 22 23 25 26 28 29										
10 km/h**	580 625 665 710 755 795 840 930 1015 1060 1100 1145 1190 1230 1275										
30 km/h	445 490 535 580 625 670 715 800 890 935 980 1020 1060 1095 1135										
40 km/h	505 550 590 635 675 760 845 890 930 965 1005 1040 1080										
50 km/h	485 525 565 610 650 730 815 855 895 930 965 1000 1035										
65 km/h	460 500 540 575 615 695 770 810 850 885 920 950 985										
40 km/h Dual	375 410 445 485 520 560 595 670 745 785 820 855 885 920 950										

Ø Pulgadas	Descripción	CAI	S mm	D mm	R' mm	Cdr. mm	Llanta recomendada	Llanta permitida	Cámara de aire (Código)	Volumen interno al 75% (litros)	Profundidad de la banda de rodamiento (mm)
20	280/70 R20 116D TL	263806	268	904	409	2690	W9	W10 W8	533	61	29
Bar	0.4 0.5 0.6 0.7 0.8 0.9 1.0 1.2 1.4 1.5 1.6 1.7 1.8 1.9 2.0										
Psi	6 7 9 10 12 13 15 17 20 22 23 25 26 28 29										
10 km/h**	640 690 740 785 835 885 935 1035 1130 1180 1230 1280 1325 1375 1425										
30 km/h	490 540 590 640 690 740 795 895 995 1045 1095 1140 1180 1225 1270										
40 km/h	565 615 660 710 755 850 945 995 1040 1080 1125 1165 1205										
50 km/h	540 585 630 680 725 815 910 955 1000 1040 1080 1120 1160										
65 km/h	515 560 600 645 690 775 865 905 950 990 1025 1065 1100										

Ø Pulgadas	Descripción	CAI	S mm	D mm	R' mm	Cdr. mm	Llanta recomendada	Llanta permitida	Cámara de aire (Código)	Volumen interno al 75% (litros)	Profundidad de la banda de rodamiento (mm)
24	320/70 R24 116D TL	415039	323	1101	497	3274	W10	W11 W9	692	94	40
Bar	0.4 0.5 0.6 0.7 0.8 0.9 1.0 1.2 1.4 1.5 1.6 1.7 1.8 1.9 2.0										
Psi	6 7 9 10 12 13 15 17 20 22 23 25 26 28 29										
10 km/h**	870 935 995 1060 1125 1185 1250 1375 1500 1565 1630 1690 1755 1815 1880										
30 km/h	670 735 800 865 925 990 1055 1185 1310 1375 1440										
40 km/h	760 820 880 945 1005 1125 1250 1310 1370										
50 km/h	720 780 840 895 955 1075 1190 1250 1310										
65 km/h	690 745 800 860 915 1025 1140 1195 1250										
40 km/h Dual	560 615 670 720 775 830 885 990 1100 1150 1205										

* Consultar las notas al final de las tablas de esta gama.

MICHELIN® OMNIBIB

Características y presiones en (Bar) y (Psi): carga por neumático en kg*

Ø Pulgadas	Descripción	CAI	S mm	D mm	R' mm	Cdr. mm	Llanta recomendada	Llanta permitida	Cámara de aire (Código)	Volumen interno al 75% (litros)	Profundidad de la banda de rodamiento (mm)			
24	360/70 R24 122D TL	198698	373	1153	513	3418	W11	W10 W12L	692	137	43			
Bar	0.4 0.5 0.6 0.7 0.8 0.9 1.0 1.2 1.4 1.5 1.6 1.7 1.8 1.9 2.0													
Psi	6 7 9 10 12 13 15 17 20 22 23 25 26 28 29													
10 km/h**	1040 1115 1190 1265 1345 1420 1495 1645 1795 1870 1950													
30 km/h	790 870 945 1025 1105 1180 1260 1415 1575 1650 1730													
40 km/h	900 975 1050 1120 1195 1345 1490 1565 1640													
50 km/h	870 940 1010 1085 1155 1295 1440 1510 1580													
65 km/h	825 895 960 1030 1095 1230 1365 1435 1500													
40 km/h Dual	665 730 795 860 925 990 1055 1185 1315 1380 1445													

Ø Pulgadas	Descripción	CAI	S mm	D mm	R' mm	Cdr. mm	Llanta recomendada	Llanta permitida	Cámara de aire (Código)	Volumen interno al 75% (litros)	Profundidad de la banda de rodamiento (mm)			
24	380/70 R24 125D TL	085816	399	1188	528	3520	W12	W11 W13	700	161	45			
Bar	0.4 0.5 0.6 0.7 0.8 0.9 1.0 1.2 1.4 1.5 1.6 1.7 1.8 1.9 2.0													
Psi	6 7 9 10 12 13 15 17 20 22 23 25 26 28 29													
10 km/h**	1130 1215 1300 1385 1470 1550 1635 1805 1975 2060 2145 2225 2310 2395 2480													
30 km/h	860 945 1035 1120 1205 1295 1380 1555 1725 1815 1900													
40 km/h	990 1070 1155 1235 1320 1480 1645 1730 1810													
50 km/h	950 1030 1105 1185 1260 1420 1575 1650 1730													
65 km/h	900 975 1050 1125 1200 1350 1500 1575 1650													
40 km/h Dual	725 795 865 940 1010 1085 1155 1300 1445 1520 1590													

Ø Pulgadas	Descripción	CAI	S mm	D mm	R' mm	Cdr. mm	Llanta recomendada	Llanta permitida	Cámara de aire (Código)	Volumen interno al 75% (litros)	Profundidad de la banda de rodamiento (mm)			
24	420/70 R24 130D TL	829095	436	1251	553	3702	W13	DW14L W12L W14L	703	203	46			
Bar	0.4 0.5 0.6 0.7 0.8 0.9 1.0 1.2 1.4 1.5 1.6 1.7 1.8 1.9 2.0													
Psi	6 7 9 10 12 13 15 17 20 22 23 25 26 28 29													
10 km/h**	1310 1405 1505 1600 1695 1790 1890 2080 2275 2370 2465 2560 2660 2755 2850													
30 km/h	1010 1110 1205 1305 1405 1500 1600 1795 1995 2090 2190													
40 km/h	1130 1225 1320 1415 1510 1700 1890 1985 2080													
50 km/h	1080 1170 1265 1355 1450 1630 1815 1910 2000													
65 km/h	1030 1115 1205 1290 1380 1550 1725 1815 1900													
40 km/h Dual	845 920 995 1080 1160 1245 1330 1495 1665 1745 1830													

* Consultar las notas al final de las tablas de esta gama.

MICHELIN® OMNIBIB

Características y presiones en (Bar) y (Psi): carga por neumático en kg*

Ø Pulgadas	Descripción	CAI	S mm	D mm	R' mm	Cdr. mm	Llanta recomendada	Llanta permitida	Cámara de aire (Código)	Volumen interno al 75% (litros)	Profundidad de la banda de rodamiento (mm)	
24	480/70 R24 138D TL	375821	494	1327	578	3916	DW15L	DW14L DW16L W14L W15L W16L	710	276	48	
Bar	0.4 0.5 0.6 0.7 0.8 0.9 1.0 1.2 1.4 1.5 1.6											
Psi	6 7 9 10 12 13 15 17 20 22 23											
10 km/h**	1590 1710 1835 1955 2080 2200 2320 2565 2810 2930 3055								3175	3295	3420	3540
30 km/h	1220 1345 1470 1595 1715 1840 1965 2215 2460 2585 2710											
40 km/h	1410 1525 1645 1760 1880 2110 2345 2465 2580											
50 km/h	1350 1465 1575 1690 1800 2030 2255 2365 2480											
65 km/h	1285 1395 1500 1610 1715 1930 2145 2255 2360											
40 km/h Dual	1020 1130 1240 1345 1445 1550 1655 1860 2070 2170 2275											

Ø Pulgadas	Descripción	CAI	S mm	D mm	R' mm	Cdr. mm	Llanta recomendada	Llanta permitida	Cámara de aire (Código)	Volumen interno al 75% (litros)	Profundidad de la banda de rodamiento (mm)	
28	380/70 R28 127D TL	118587	390	1294	580	3842	W12	W11 W13	732	179	45	
Bar	0.4 0.5 0.6 0.7 0.8 0.9 1.0 1.2 1.4 1.5 1.6											
Psi	6 7 9 10 12 13 15 17 20 22 23											
10 km/h**	1200 1290 1380 1470 1560 1645 1735 1915 2095 2185 2275								2360	2450	2540	2630
30 km/h	920 1010 1100 1195 1285 1375 1465 1645 1830 1920 2010											
40 km/h	1040 1130 1215 1305 1390 1570 1745 1830 1920											
50 km/h	1000 1085 1170 1250 1335 1505 1670 1755 1840											
65 km/h	950 1030 1110 1190 1270 1430 1590 1670 1750											
40 km/h Dual	770 845 915 990 1070 1145 1225 1375 1530 1610 1685											

Ø Pulgadas	Descripción	CAI	S mm	D mm	R' mm	Cdr. mm	Llanta recomendada	Llanta permitida	Cámara de aire (Código)	Volumen interno al 75% (litros)	Profundidad de la banda de rodamiento (mm)	
28	420/70 R28 133D TL	532215	436	1354	602	4012	W13	DW14L W12 W14L	821	231	46	
Bar	0.4 0.5 0.6 0.7 0.8 0.9 1.0 1.2 1.4 1.5 1.6											
Psi	6 7 9 10 12 13 15 17 20 22 23											
10 km/h**	1390 1495 1605 1710 1815 1920 2030 2240 2455 2560 2665								2770	2880	2985	3090
30 km/h	1060 1170 1280 1390 1495 1605 1715 1935 2150 2260 2370											
40 km/h	1230 1335 1435 1540 1640 1850 2055 2155 2260											
50 km/h	1180 1280 1375 1475 1570 1770 1965 2060 2160											
65 km/h	1120 1215 1310 1400 1495 1685 1870 1965 2060											
40 km/h Dual	890 985 1080 1170 1260 1350 1440 1625 1805 1895 1985											

* Consultar las notas al final de las tablas de esta gama.

MICHELIN® OMNIBIB

Características y presiones en (Bar) y (Psi): carga por neumático en kg*

Ø Pulgadas	Descripción	CAI	S mm	D mm	R' mm	Cdr. mm	Llanta recomendada	Llanta permitida	Cámara de aire (Código)	Volumen interno al 75% (litros)	Profundidad de la banda de rodamiento (mm)				
28	480/70 R28 140D TL	570026	500	1427	632	4217	DW15L	DW14L DW16L W14L W15L W16L	822	302	48				
Bar	0.4	0.5	0.6	0.7	0.8	0.9	1.0	1.2	1.4	1.5	1.6	1.7	1.8	1.9	2.0
Psi	6	7	9	10	12	13	15	17	20	22	23	25	26	28	29
10 km/h**	1730	1855	1985	2110	2235	2360	2490	2740	2995	3120	3245	3370	3500	3625	3750
30 km/h	1320	1450	1580	1710	1840	1970	2100	2360	2620	2750	2880				
40 km/h			1490	1615	1740	1865	1990	2240	2490	2615	2740				
50 km/h			1430	1550	1670	1790	1910	2150	2390	2510	2630				
65 km/h			1360	1475	1590	1700	1815	2045	2270	2385	2500				
40 km/h Dual	1110	1210	1310	1420	1530	1640	1750	1970	2190	2300	2410				

Ø Pulgadas	Descripción	CAI	S mm	D mm	R' mm	Cdr. mm	Llanta recomendada	Llanta permitida	Cámara de aire (Código)	Volumen interno al 75% (litros)	Profundidad de la banda de rodamiento (mm)				
30	480/70 R30 141D TL	599351	498	1482	656	4388	DW15L	DW14L DW16L W14L W15L W16L	754	317	48				
Bar	0.4	0.5	0.6	0.7	0.8	0.9	1.0	1.2	1.4	1.5	1.6	1.7	1.8	1.9	2.0
Psi	6	7	9	10	12	13	15	17	20	22	23	25	26	28	29
10 km/h**	1770	1900	2030	2160	2295	2425	2555	2815	3075	3205	3340	3470	3600	3730	3860
30 km/h	1360	1495	1625	1760	1895	2025	2160	2425	2695	2825	2960				
40 km/h			1530	1660	1790	1915	2045	2305	2560	2690	2820				
50 km/h			1470	1595	1715	1840	1960	2210	2455	2575	2700				
65 km/h			1400	1520	1635	1755	1870	2105	2340	2460	2575				
40 km/h Dual	1135	1245	1350	1465	1575	1690	1800	2030	2255	2365	2480				

Ø Pulgadas	Descripción	CAI	S mm	D mm	R' mm	Cdr. mm	Llanta recomendada	Llanta permitida	Cámara de aire (Código)	Volumen interno al 75% (litros)	Profundidad de la banda de rodamiento (mm)				
34	480/70 R34 143D TL	280033	497	1593	713	4728	DW15L	DW14L DW16L W14L W15L W16L	704	345	50				
Bar	0.4	0.5	0.6	0.7	0.8	0.9	1.0	1.2	1.4	1.5	1.6	1.7	1.8	1.9	2.0
Psi	6	7	9	10	12	13	15	17	20	22	23	25	26	28	29
10 km/h**	1880	2020	2155	2295	2435	2570	2710	2985	3260	3400	3540	3675	3815	3950	4090
30 km/h	1440	1580	1720	1865	2005	2145	2285	2565	2850	2990	3130				
40 km/h			1640	1775	1910	2040	2175	2445	2710	2845	2980				
50 km/h			1580	1710	1835	1965	2090	2350	2605	2730	2860				
65 km/h			1500	1625	1745	1870	1990	2235	2480	2605	2725				
40 km/h Dual	1205	1325	1445	1565	1680	1800	1915	2155	2390	2505	2625				

* Consultar las notas al final de las tablas de esta gama.

MICHELIN® OMNIBIB

Características y presiones en (Bar) y (Psi): carga por neumático en kg*

Ø Pulgadas	Descripción	CAI	S mm	D mm	R' mm	Cdr. mm	Llanta recomendada	Llanta permitida	Cámara de aire (Código)	Volumen interno al 75% (litros)	Profundidad de la banda de rodamiento (mm)
34	520/70 R34 148D TL	939411	535	1651	730	4887	DW16L	DW15L DW18L W15L W16L W18L	823	422	53
Bar	0.4 0.5 0.6 0.7 0.8 0.9 1.0 1.2 1.4 1.5 1.6								1.7 1.8 1.9 2.0		
Psi	6 7 9 10 12 13 15 17 20 22 23								25 26 28 29		
10 km/h**	2100 2265 2430 2595 2760 2920 3085 3415 3745 3910 4075								4235 4400 4565 4730		
30 km/h	1610 1780 1945 2115 2280 2450 2615 2950 3285 3455 3620										
40 km/h	1860 2020 2180 2335 2495 2815 3130 3290 3450										
50 km/h	1790 1940 2095 2245 2400 2700 3005 3160 3310										
65 km/h	1700 1845 1990 2135 2280 2570 2860 3005 3150										
40 km/h Dual	1350 1495 1640 1780 1920 2060 2200 2475 2755 2895 3035										

Ø Pulgadas	Descripción	CAI	S mm	D mm	R' mm	Cdr. mm	Llanta recomendada	Llanta permitida	Cámara de aire (Código)	Volumen interno al 75% (litros)	Profundidad de la banda de rodamiento (mm)
38	480/70 R38 145D TL	936570	498	1694	759	5030	DW15L	DW14L DW16L W14L W15L W16L	786	377	52
Bar	0.4 0.5 0.6 0.7 0.8 0.9 1.0 1.2 1.4 1.5 1.6								1.7 1.8 1.9 2.0		
Psi	6 7 9 10 12 13 15 17 20 22 23								25 26 28 29		
10 km/h**	1980 2130 2275 2425 2575 2720 2870 3165 3460 3610 3760								3905 4055 4200 4350		
30 km/h	1520 1670 1825 1975 2125 2280 2430 2735 3035 3190 3340										
40 km/h	1750 1895 2035 2180 2320 2610 2895 3035 3180										
50 km/h	1680 1815 1955 2090 2230 2500 2775 2915 3050										
65 km/h	1600 1730 1860 1990 2120 2380 2640 2770 2900										
40 km/h Dual	1270 1405 1540 1665 1790 1915 2040 2295 2545 2670 2795										

Ø Pulgadas	Descripción	CAI	S mm	D mm	R' mm	Cdr. mm	Llanta recomendada	Llanta permitida	Cámara de aire (Código)	Volumen interno al 75% (litros)	Profundidad de la banda de rodamiento (mm)
38	520/70 R38 150D TL	833744	539	1766	782	5229	DW16L	DW15L DW18L W15L W16L W18L	824	464	53
Bar	0.4 0.5 0.6 0.7 0.8 0.9 1.0 1.2 1.4 1.5 1.6								1.7 1.8 1.9 2.0		
Psi	6 7 9 10 12 13 15 17 20 22 23								25 26 28 29		
10 km/h**	2250 2425 2600 2770 2945 3120 3295 3640 3990 4160 4335								4510 4685 4855 5030		
30 km/h	1730 1905 2085 2260 2435 2615 2790 3145 3495 3675 3850										
40 km/h	1970 2140 2310 2480 2650 2990 3330 3500 3670										
50 km/h	1890 2055 2215 2380 2540 2870 3195 3355 3520										
65 km/h	1800 1955 2110 2265 2420 2730 3040 3195 3350										
40 km/h Dual	1445 1590 1735 1885 2035 2185 2335 2630 2930 3080 3230										

* Consultar las notas al final de las tablas de esta gama.

MICHELIN® OMNIBIB

Características y presiones en (Bar) y (Psi): carga por neumático en kg*

Ø Pulgadas	Descripción	CAI	S mm	D mm	R' mm	Cdr. mm	Llanta recomendada	Llanta permitida	Cámara de aire (Código)	Volumen interno al 75% (litros)	Profundidad de la banda de rodamiento (mm)				
38	580/70 R38 155D TL	001240	601	1836	815	5440	DW18L	W18L	825	590	56				
Bar	0.4	0.5	0.6	0.7	0.8	0.9	1.0	1.2	1.4	1.5	1.6	1.7	1.8	1.9	2.0
Psi	6	7	9	10	12	13	15	17	20	22	23	25	26	28	29
10 km/h**	2630	2830	3030	3225	3425	3625	3825	4220	4620	4815	5015	5215	5415	5610	5810
30 km/h	2010	2215	2420	2625	2825	3030	3235	3645	4050	4255	4460				
40 km/h			2320	2510	2705	2895	3090	3470	3855	4050	4240				
50 km/h			2230	2415	2600	2780	2965	3335	3700	3885	4070				
65 km/h			2120	2295	2470	2645	2820	3175	3525	3700	3875				
40 km/h Dual	1685	1865	2045	2215	2385	2550	2720	3060	3395	3565	3735				

Ø Pulgadas	Descripción	CAI	S mm	D mm	R' mm	Cdr. mm	Llanta recomendada	Llanta permitida	Cámara de aire (Código)	Volumen interno al 75% (litros)	Profundidad de la banda de rodamiento (mm)				
42	620/70 R42 160D TL	989457	639	1953	863	5781	DW20B (A)	DW18L	802	658	58				
Bar	0.4	0.5	0.6	0.7	0.8	0.9	1.0	1.2	1.4	1.5	1.6	1.7	1.8	1.9	2.0
Psi	6	7	9	10	12	13	15	17	20	22	23	25	26	28	29
10 km/h**	3090	3320	3550	3775	4005	4235	4465	4920	5380	5605	5835	6065	6295	6520	6750
30 km/h	2370	2605	2840	3075	3305	3540	3775	4245	4710	4945	5180				
40 km/h			2660	2885	3115	3340	3570	4020	4475	4705	4930				
50 km/h			2550	2770	2985	3205	3420	3860	4295	4510	4730				
65 km/h			2430	2635	2845	3050	3260	3670	4085	4295	4500				
40 km/h Dual	1985	2165	2340	2540	2740	2940	3140	3535	3935	4135	4335				

***IMPORTANTE:**

La presión de inflado se determina siempre en función de la carga por neumático, de la velocidad y del trabajo a realizar. Las recomendaciones anteriores se facilitan con la salvedad de modificaciones posteriores a la fecha de difusión de estas tablas (junio de 2018). Los datos técnicos pueden sufrir modificaciones sin previo aviso.

- Para labranza y otras aplicaciones en las que se requiere un alto par motor, utilizar la línea de 30 km/h.
 - Para uso en laderas: añadir 0.4 Bar.
 - Para uso intensivo en carretera: añadir 0.4 Bar.
 - 40 km/h Dual: uso en montaje gemelado.
- **10 km/h LT (torque bajo) (velocidad máxima 10 km/h).



MICHELIN® YIELDBIB

EL NEUMÁTICO DE
BAJA PRESIÓN PARA
APLICACIONES EN
CULTIVOS EN LÍNEA DE
ALTA POTENCIA



Para tractores de **160 a 550 HP**



VF Very High Flexion



**Protección de los suelos: área de contacto con el suelo
+27% más grande** ⁽¹⁾



Más **tracción** con gajos diseñados a 45° ⁽²⁾



Productividad: misma capacidad de carga con **40% menos presión**

(1) Prueba de MICHELIN® realizada en 2016, neumáticos VF 480/80 R50 Yieldbib frente a los 480/80 R50 AGRIBIB.

(2) Comparados con los neumáticos estándar de la competencia con gajos a 23°.

DIMENSIONES

VF 380/85 R34 149A8/149B TL

VF 420/85 R34 154A8/154B TL

VF 380/80 R38 149A8/149B TL

VF 380/95 R38 154A8/154B TL

VF 480/80 R46 164A8/164B TL

VF 480/80 R50 166A8/166B TL

VF 480/95 R50 170A8/170B TL

MICHELIN® YIELDBIB

Características y presiones en (Bar) y (Psi): carga por neumático en kg*

Ø Pulgadas	Descripción	CAI	S mm	D mm	R' mm	Cdr. mm	Llanta recomendada	Llanta permitida	Cámara de aire (Código)	Volumen interno al 75% (litros)	Profundidad de la banda de rodamiento (mm)
34	VF 380/85 R34 149A8/149B TL	305457	372	1510	668	4471	W13	W12	704	230	44
Bar	0.4 0.5 0.6 0.7 0.8 0.9 1.0 1.1 1.2 1.3 1.4 1.5 1.6										
Psi	6 7 9 10 12 13 15 16 17 19 20 22 23										
50 km/h	1450 1600 1750 1900 2050 2200 2350 2500 2650 2800 2950 3100 3250										
50 km/h Dual	1280 1410 1545 1675 1805 1940 2070 2200 2335 2465 2595 2730 2860										
50 km/h Triple	1190 1315 1435 1560 1680 1805 1930 2050 2175 2295 2420 2540 2665										

Ø Pulgadas	Descripción	CAI	S mm	D mm	R' mm	Cdr. mm	Llanta recomendada	Llanta permitida	Cámara de aire (Código)	Volumen interno al 75% (litros)	Profundidad de la banda de rodamiento (mm)
34	VF 420/85 R34 154A8/154B TL	012445	432	1582	699	4682	DW15L	DW14A (L) W14L W15A (L)	704	287	48
Bar	0.4 0.5 0.6 0.7 0.8 0.9 1.0 1.1 1.2 1.3 1.4 1.5 1.6										
Psi	6 7 9 10 12 13 15 16 17 19 20 22 23										
50 km/h	1700 1870 2045 2215 2390 2560 2730 2905 3075 3245 3415 3580 3750										
50 km/h Dual	1500 1650 1800 1950 2105 2255 2405 2555 2705 2855 3005 3150 3300										
50 km/h Triple	1290 1420 1555 1685 1815 1945 2080 2210 2340 2470 2595 2725 2850										

Ø Pulgadas	Descripción	CAI	S mm	D mm	R' mm	Cdr. mm	Llanta recomendada	Llanta permitida	Cámara de aire (Código)	Volumen interno al 75% (litros)	Profundidad de la banda de rodamiento (mm)
38	VF 380/80 R38 149A8/149B TL	870363	366	1592	711	4851	DW12A	W12 W13	796 795	230	45
Bar	0.4 0.5 0.6 0.7 0.8 0.9 1.0 1.1 1.2 1.3 1.4 1.5 1.6										
Psi	6 7 9 10 12 13 15 16 17 19 20 22 23										
50 km/h	1450 1600 1755 1905 2055 2210 2360 2510 2655 2805 2955 3100 3250										
50 km/h Dual	1280 1415 1545 1680 1815 1945 2080 2210 2340 2470 2600 2730 2860										
50 km/h Triple	1190 1315 1440 1565 1685 1810 1935 2055 2180 2300 2420 2545 2665										

Ø Pulgadas	Descripción	CAI	S mm	D mm	R' mm	Cdr. mm	Llanta recomendada	Llanta permitida	Cámara de aire (Código)	Volumen interno al 75% (litros)	Profundidad de la banda de rodamiento (mm)
38	VF 380/95 R38 154A8/154B TL	873023	377	1703	755	5044	DW12A	W12	795 796	286	47
Bar	0.4 0.5 0.6 0.7 0.8 0.9 1.0 1.1 1.2 1.3 1.4 1.5 1.6										
Psi	6 7 9 10 12 13 15 16 17 19 20 22 23										
50 km/h	1700 1870 2040 2215 2385 2555 2725 2895 3065 3240 3410 3580 3750										
50 km/h Dual	1500 1650 1800 1950 2100 2250 2400 2550 2700 2850 3000 3150 3300										
50 km/h Triple	1400 1540 1680 1820 1955 2095 2235 2375 2515 2655 2795 2935 3075										

* Consultar las notas al final de las tablas de esta gama.

MICHELIN® YIELDBIB

Características y presiones en (Bar) y (Psi): carga por neumático en kg*

Ø Pulgadas	Descripción	CAI	S mm	D mm	R' mm	Cdr. mm	Llanta recomendada	Llanta permitida	Cámara de aire (Código)	Volumen interno al 75% (litros)	Profundidad de la banda de rodamiento (mm)
46	VF 480/80 R46 164A8/164B TL	842300	480	1933	861	5732	DW16A	DW15L DW16B DW16L W16A	834	449	52
Bar	0.4 0.5 0.6 0.7 0.8 0.9 1.0 1.1 1.2 1.3 1.4 1.5 1.6										
Psi	6 7 9 10 12 13 15 16 17 19 20 22 23										
50 km/h	2300 2525 2750 2975 3200 3425 3650 3875 4100 4325 4550 4775 5000										
50 km/h Dual	2025 2225 2420 2620 2815 3015 3215 3410 3610 3805 4005 4200 4400										
50 km/h Triple	1660 1820 1985 2145 2305 2470 2630 2790 2955 3115 3275 3440 3600										

Ø Pulgadas	Descripción	CAI	S mm	D mm	R' mm	Cdr. mm	Llanta recomendada	Llanta permitida	Cámara de aire (Código)	Volumen interno al 75% (litros)	Profundidad de la banda de rodamiento (mm)
50	VF 480/80 R50 166A8/166B TL	309830	468	2039	901	6034	DW16A (L)	DW15B (A), W15B (A), DW16B, W16B, DW15L		479	49
Bar	0.4 0.5 0.6 0.7 0.8 0.9 1.0 1.1 1.2 1.3 1.4 1.5 1.6										
Psi	6 7 9 10 12 13 15 16 17 19 20 22 23										
50 km/h	2360 2595 2835 3070 3305 3540 3780 4015 4250 4515 4775 5040 5300										
50 km/h Dual	2075 2285 2490 2700 2910 3115 3325 3530 3740 3970 4200 4430 4660										
50 km/h Triple	1930 2125 2320 2515 2710 2905 3100 3295 3490 3705 3920 4135 4350										

Ø Pulgadas	Descripción	CAI	S mm	D mm	R' mm	Cdr. mm	Llanta recomendada	Llanta permitida	Cámara de aire (Código)	Volumen interno al 75% (litros)	Profundidad de la banda de rodamiento (mm)
50	VF 480/95 R50 170A8/170B TL	252129	477	2186	962	6464	DW16A (L)	DW15B (A), W15B (A), DW16B, W16B, DW15L		593	51
Bar	0.4 0.5 0.6 0.7 0.8 0.9 1.0 1.1 1.2 1.3 1.4 1.5 1.6										
Psi	6 7 9 10 12 13 15 16 17 19 20 22 23										
50 km/h	2725 3010 3295 3580 3865 4145 4430 4715 5000 5250 5500 5750 6000										
50 km/h Dual	2400 2650 2900 3150 3400 3650 3900 4150 4400 4620 4840 5060 5280										
50 km/h Triple	2235 2470 2700 2935 3170 3400 3635 3865 4100 4305 4510 4715 4920										

***IMPORTANTE:**

La presión de inflado se determina siempre en función de la carga por neumático, de la velocidad y del trabajo a realizar. Las recomendaciones anteriores se facilitan con la salvedad de modificaciones posteriores a la fecha de difusión de estas tablas (junio de 2018). Los datos técnicos pueden sufrir modificaciones sin previo aviso.

- Cuando se utiliza la configuración de montaje simple (single):
 - Añadir 0.4 Bar para usar en pendientes superiores al 20%
 - Añadir 0.4 Bar para uso pesado en carreteras superiores al 50%



MICHELIN® AGRIBIB 2

ALTOS NIVELES DE
RENDIMIENTO DURANTE
TODA SU VIDA ÚTIL



Para tractores de **60 a 170 HP**
y hasta **500 HP con montaje gemelado**
(42", 46", 50")



TRACCIÓN ÓPTIMA con gajos a un ángulo de 45°



Gran DURACIÓN gracias a su banda de rodamiento con gajos profundos. Banda de rodamiento con gajos hasta 8% más profundos que los que ofrecen⁽¹⁾ los principales competidores en R1W⁽¹⁾



ROBUSTEZ
Un índice de carga hasta 18% más alto⁽²⁾

(1) MICHELIN® AGRIBIB 2 480/80R50 frente a las profundidades difundidas de los principales competidores.

(2) Dependiendo de las dimensiones y para la dimensión 520/85 R46 164A8/164B.

DIMENSIONES

480/80 R26 149A8/149B TL
280/85 R28 123A8/120D TL
420/85 R28 144A8/144B TL
380/85 R30 140A8/140B TL
420/85 R30 145A8/145B TL
420/90 R30 147A8/147B TL
650/75 R32 167A8/167B TL

320/85 R34 133A8/133B TL
380/85 R34 142A8/142B TL
420/85 R34 147A8/147B TL **NUEVO**
380/80 R38 142A8/139D TL
420/85 R38 149A8/149B TL
520/85 R38 160A8/160B TL
480/80 R42 156A8/156B TL

520/85 R42 162A8/162B TL
420/80 R46 151A8/151B TL
480/80 R46 158A8/158B TL
520/85 R46 164A8/164B TL
480/80 R50 159A8/159B TL
380/90 R54 152A8/152B TL

MICHELIN® AGRIBIB 2

Características y presiones en (Bar) y (Psi): carga por neumático en kg*

Ø Pulgadas	Descripción	CAI	S mm	D mm	R' mm	Cdr. mm	Llanta recomendada	Llanta permitida	Cámara de aire (Código)	Volumen interno al 75% (litros)	Profundidad de la banda de rodamiento (mm)
26	480/80 R26 149A8/149B TL	466081	500	1416	633	4202	DW16B (A)	DW15B(A)		297	50
Bar	0.4 0.6 0.8 1.0 1.2 1.4 1.6 1.7 1.8 1.9 2.1 2.3 2.4 2.6 2.8										
Psi	6 9 12 15 17 20 23 25 26 28 30 33 35 38 41										
40 km/h Dual	1320 1540 1755 1970 2185 2400 2460 2515 2575 2690 2805 2860										
10 km/h**	1875 2245 2620 2990 3360 3555 3750 3865 3975 4090 4285 4455 4540 4705 4875										
30 km/h	1340 1605 1875 2135 2395 2655 2915 2985 3055 3125 3270 3410 3480										
40 km/h	1500 1750 1995 2240 2485 2725 2790 2855 2920 3055 3185 3250										
50 km/h	1500 1750 1995 2240 2485 2725 2790 2855 2920 3055 3185 3250										

Ø Pulgadas	Descripción	CAI	S mm	D mm	R' mm	Cdr. mm	Llanta recomendada	Llanta permitida	Cámara de aire (Código)	Volumen interno al 75% (litros)	Profundidad de la banda de rodamiento (mm)
28	280/85 R28 123A8/120D TL <i>11. R28</i>	392931	299	1192	545	3563	W10	W9	725	98	40
Bar	0.4 0.6 0.8 1.0 1.2 1.4 1.6 1.8 2.0 2.2 2.4 2.6 2.8 3.0 3.2										
Psi	6 9 12 15 17 20 23 26 29 32 35 38 41 44 46										
10 km/h**	900 1075 1245 1420 1590 1680 1770 1905 2040 2110 2185 2255 2325										
30 km/h	640 760 885 1010 1135 1275 1410 1475 1535 1600 1660										
40 km/h	710 825 945 1060 1190 1320 1380 1435 1495 1550										
50 km/h	645 750 860 965 1085 1200 1255 1305 1360 1410										
65 km/h	645 750 860 965 1085 1200 1255 1305 1360 1410										
40 km/h Dual	625 725 830 935 1050 1160 1210 1265 1315 1365										

Ø Pulgadas	Descripción	CAI	S mm	D mm	R' mm	Cdr. mm	Llanta recomendada	Llanta permitida	Cámara de aire (Código)	Volumen interno al 75% (litros)	Profundidad de la banda de rodamiento (mm)
28	420/85 R28 144A8/144B TL	135905	449	1419	645	4226	DW15L	DW14L, W14L, W15L	822	248	50.5
Bar	0.4 0.6 0.8 1.0 1.2 1.4 1.6 1.7 1.8 1.9 2.0 2.2 2.4 2.6 2.8										
Psi	6 9 12 15 17 20 23 25 26 28 29 32 35 38 41										
40 km/h Dual	1160 1365 1565 1760 1950 2140 2180 2220 2260 2305 2385 2465										
10 km/h**	1680 2010 2340 2670 3000 3180 3360 3460 3555 3655 3750 3865 3975 4090 4200										
30 km/h	1200 1410 1660 1900 2140 2370 2600 2650 2700 2750 2800 2895 2995										
40 km/h	1320 1550 1775 2000 2215 2430 2475 2525 2570 2615 2710 2800										
50 km/h	1320 1550 1775 2000 2215 2430 2475 2525 2570 2615 2710 2800										

* Consultar las notas al final de las tablas de esta gama.

MICHELIN® AGRIBIB 2

Características y presiones en (Bar) y (Psi): carga por neumático en kg*

Ø Pulgadas	Descripción	CAI	S mm	D mm	R' mm	Cdr. mm	Llanta recomendada	Llanta permitida	Cámara de aire (Código)	Volumen interno al 75% (litros)	Profundidad de la banda de rodamiento (mm)
30	380/85 R30 140A8/140B TL 14.9 R30	151572	394	1416	644	4219	W12	W13	734	229	47
Bar	0.4 0.6 0.8 1.0 1.2 1.4 1.6 1.8 2.0 2.2 2.4 2.6 2.8 3.0 3.2										
Psi	6 9 12 15 17 20 23 26 29 32 35 38 41 44 46										
10 km/h**	1465 1755 2045 2335 2625 2775 2925 3145 3360 3460 3555 3655 3750										
30 km/h	1045 1265 1455 1665 1875 2105 2335 2420 2505 2590 2675										
40 km/h	1180 1360 1555 1750 1965 2180 2260 2340 2420 2500										
50 km/h	1180 1360 1555 1750 1965 2180 2260 2340 2420 2500										
40 km/h Dual	1040 1195 1370 1540 1730 1920 1990 2060 2130 2200										

Ø Pulgadas	Descripción	CAI	S mm	D mm	R' mm	Cdr. mm	Llanta recomendada	Llanta permitida	Cámara de aire (Código)	Volumen interno al 75% (litros)	Profundidad de la banda de rodamiento (mm)
30	420/85 R30 145A8/145B TL	002919	445	1476		4385	DW15L	W14L, DW14L, W15L		263	49
Bar	0.4 0.6 0.8 1.0 1.2 1.4 1.6 1.7 1.8 1.9 2.1 2.4 2.5 2.7 2.8										
Psi	6 9 12 15 17 20 23 25 26 28 30 35 36 39 41										
40 km/h Dual	1195 1410 1610 1815 2010 2200 2245 2290 2330 2420 2550										
10 km/h**	1725 2065 2410 2750 3090 3090 3450 3555 3660 3760 3925 4110 4170 4290 4350										
30 km/h	1230 1455 1710 1960 2205 2440 2675 2730 2780 2835 2945 3105										
40 km/h	1360 1600 1830 2060 2280 2500 2550 2600 2650 2750 2900										
50 km/h	1360 1600 1830 2060 2280 2500 2550 2600 2650 2750 2900										

Ø Pulgadas	Descripción	CAI	S mm	D mm	R' mm	Cdr. mm	Llanta recomendada	Llanta permitida	Cámara de aire (Código)	Volumen interno al 75% (litros)	Profundidad de la banda de rodamiento (mm)
30	420/90 R30 147A8/147B TL	508522	418	1518	684	4513	DW13	DW14L W13 W14L	754	284	50
Bar	0.4 0.6 0.8 1.0 1.2 1.4 1.6 1.8 2.0 2.2 2.4 2.6 2.8 3.0 3.2										
Psi	6 9 12 15 17 20 23 26 29 32 35 38 41 44 46										
10 km/h**	1825 2120 2420 2715 3015 3310 3605 3905 4200 4305 4410 4510 4615										
30 km/h	1300 1550 1810 2075 2335 2585 2835 2970 3105 3200 3290										
40 km/h	1450 1700 1940 2180 2415 2650 2775 2900 2990 3075										
50 km/h	1450 1700 1940 2180 2415 2650 2775 2900 2990 3075										
40 km/h Dual	1070 1275 1495 1710 1920 2125 2330 2425 2520 2610 2705										

* Consultar las notas al final de las tablas de esta gama.

MICHELIN® AGRIBIB 2

Características y presiones en (Bar) y (Psi): carga por neumático en kg*

Ø Pulgadas	Descripción	CAI	S mm	D mm	R' mm	Cdr. mm	Llanta recomendada	Llanta permitida	Cámara de aire (Código)	Volumen interno al 75% (litros)	Profundidad de la banda de rodamiento (mm)
32	650/75 R32 167A8/167B TL	533727	667	1827	811	5415	DW20B (A)	DW21B (A)	831	647	54
Bar	0.4 0.6 0.8 1.0 1.2 1.4 1.6 1.7 1.8 2.0 2.2 2.4 2.5 2.7 2.8										
Psi	6 9 12 15 17 20 23 25 26 29 32 35 36 39 41										
40 km/h Dual	2265 2640 3025 3410 3740 4070 4160 4250 4435 4615 4795										
10 km/h**	3180 3840 4500 5155 5815 6095 6375 6565 6750 7125 7390 7650 7780 8045 8175										
30 km/h	2270 2755 3210 3680 4145 4550 4950 5060 5170 5390 5610 5830										
40 km/h	2575 3000 3440 3875 4250 4625 4730 4830 5040 5245 5450										
50 km/h	2575 3000 3440 3875 4250 4625 4730 4830 5040 5245 5450										

Ø Pulgadas	Descripción	CAI	S mm	D mm	R' mm	Cdr. mm	Llanta recomendada	Llanta permitida	Cámara de aire (Código)	Volumen interno al 75% (litros)	Profundidad de la banda de rodamiento (mm)
34	320/85 R34 133A8/133B TL <i>12.4 R34</i>	908266	312	1421	653	4243	W10			155	44
Bar	0.4 0.6 0.8 1.0 1.2 1.4 1.6 1.8 2.0 2.2 2.4 2.6 2.8 3.0 3.2										
Psi	6 9 12 15 17 20 23 26 29 32 35 38 41 44 46										
10 km/h**	1200 1445 1690 1930 2175 2290 2400 2550 2700 2800 2895 2995 3090										
30 km/h	855 1045 1200 1375 1550 1715 1875 1960 2040 2125 2205										
40 km/h	975 1120 1285 1450 1600 1750 1830 1905 1985 2060										
50 km/h	975 1120 1285 1450 1600 1750 1830 1905 1985 2060										
40 km/h Dual	705 860 985 1130 1275 1410 1540 1610 1680 1745 1815										

Ø Pulgadas	Descripción	CAI	S mm	D mm	R' mm	Cdr. mm	Llanta recomendada	Llanta permitida	Cámara de aire (Código)	Volumen interno al 75% (litros)	Profundidad de la banda de rodamiento (mm)
34	380/85 R34 142A8/142B TL <i>14.9 R34</i>	009860	378	1516	691	4519	W12	W13	704	286	47
Bar	0.4 0.6 0.8 1.0 1.2 1.4 1.6 1.8 2.0 2.2 2.4 2.6 2.8 3.0 3.2										
Psi	6 9 12 15 17 20 23 26 29 32 35 38 41 44 46										
10 km/h**	1545 1855 2160 2470 2775 2935 3090 3315 3540 3650 3760 3865 3975										
30 km/h	1100 1340 1550 1765 1980 2220 2460 2555 2650 2740 2835										
40 km/h	1250 1450 1650 1850 2075 2300 2390 2475 2565 2650										
50 km/h	1250 1450 1650 1850 2075 2300 2390 2475 2565 2650										
40 km/h Dual	1100 1275 1455 1630 1830 2025 2100 2180 2255 2330										

* Consultar las notas al final de las tablas de esta gama.

MICHELIN® AGRIBIB 2

Características y presiones en (Bar) y (Psi): carga por neumático en kg*

Ø Pulgadas	Descripción	CAI	S mm	D mm	R' mm	Cdr. mm	Llanta recomendada	Llanta permitida	Cámara de aire (Código)	Volumen interno al 75% (litros)	Profundidad de la banda de rodamiento (mm)
34	420/85R34 147A8/147B TL 16.9 R34	183733	449	1589	720	4730	DW15L	W13 DW14L W14L W15L	704	287	48.5
Bar	0.4 0.6 0.8 1 1.2 1.4 1.6 1.8 2 2.2 2.4 2.6 2.8										
Psi	6 9 12 15 17 20 23 26 29 32 35 38 41										
10 km/h**	1300 1795 2285 2780 3270 3460 3645 3870 4090 4220 4355 4485 4615										
30 km/h	1300 1550 1820 2080 2335 2585 2835 2950 3065 3175 3290										
40 km/h	1450 1700 1940 2180 2415 2650 2755 2865 2970 3075										
40 km/h Dual	1070 1275 1495 1710 1920 2125 2330 2425 2520 2610 2705										
50 km/h	1450 1700 1940 2180 2415 2650 2755 2865 2970 3075										

Ø Pulgadas	Descripción	CAI	S mm	D mm	R' mm	Cdr. mm	Llanta recomendada	Llanta permitida	Cámara de aire (Código)	Volumen interno al 75% (litros)	Profundidad de la banda de rodamiento (mm)
38	380/80 R38 142A8/139D TL	187095	380	1595	729	4755	DW12A	DW12 DW13 W12 W13	796 795	230	46
Bar	0.4 0.6 0.8 1.0 1.2 1.4 1.6 1.8 2.0 2.2 2.4 2.6 2.8 3.0 3.2										
Psi	6 9 12 15 17 20 23 26 29 32 35 38 41 44 46										
10 km/h**	1545 1870 2200 2525 2850 2970 3090 3315 3540 3650 3760 3865 3975										
30 km/h	1100 1340 1550 1795 2035 2250 2460 2555 2650 2740 2835										
40 km/h	1250 1450 1675 1900 2100 2300 2390 2475 2565 2650										
50 km/h	1250 1450 1675 1900 2100 2300 2390 2475 2565 2650										
65 km/h	1140 1320 1525 1730 1915 2095 2175 2255 2330 2410										
40 km/h Dual	1100 1275 1475 1670 1850 2025 2100 2180 2255 2330										

Ø Pulgadas	Descripción	CAI	S mm	D mm	R' mm	Cdr. mm	Llanta recomendada	Llanta permitida	Cámara de aire (Código)	Volumen interno al 75% (litros)	Profundidad de la banda de rodamiento (mm)
38	420/85 R38 149A8/149B TL NUEVO 16.9 R38	048439	450	1690	769	5035	DW15L	DW14L W14L W15L	786	293	49
Bar	0.4 0.6 0.8 1.0 1.2 1.4 1.6 1.8 2.0 2.2 2.4 2.6 2.8										
Psi	6 9 12 15 17 20 23 26 29 32 35 38 41										
10 km/h**	1930 2250 2575 2895 3215 3535 3860 4180 4500 4595 4690 4780 4875										
30 km/h	1375 1660 1925 2195 2460 2730 2995 3145 3290 3385 3480										
40 km/h	1550 1800 2050 2300 2550 2800 2940 3075 3165 3250										
50 km/h	1550 1800 2050 2300 2550 2800 2940 3075 3165 3250										
40 km/h Dual	1130 1365 1585 1805 2025 2245 2465 2565 2665 2760 2860										

* Consultar las notas al final de las tablas de esta gama.

MICHELIN® AGRIBIB 2

Características y presiones en (Bar) y (Psi): carga por neumático en kg*

Ø Pulgadas	Descripción	CAI	S mm	D mm	R' mm	Cdr. mm	Llanta recomendada	Llanta permitida	Cámara de aire (Código)	Volumen interno al 75% (litros)	Profundidad de la banda de rodamiento (mm)		
38	520/85 R38 160A8/160B TL 20.8 R38	882358	533	1849	831	5493	DW16L	DD16 DD18 DW18L W16A W18A	825	508	55		
Bar	0.4 0.6 0.8 1.0 1.2 1.4 1.6 1.8 2.0 2.2 2.4 2.6 2.8 3.0 3.2												
Psi	6 9 12 15 17 20 23 26 29 32 35 38 41 44 46												
10 km/h**	2625	3070	3515	3960	4410	4855	5300	5745	6190	6630	6470	6610	6750
30 km/h	1875	2270	2635	3005	3370	3760	4145	4350	4550	4685	4815		
40 km/h		2120	2500	2825	3150	3515	3875	4065	4250	4375	4500		
50 km/h		2120	2500	2825	3150	3515	3875	4065	4250	4375	4500		
40 km/h Dual	1540	1865	2200	2485	2770	3090	3410	3550	3685	3825	3960		

Ø Pulgadas	Descripción	CAI	S mm	D mm	R' mm	Cdr. mm	Llanta recomendada	Llanta permitida	Cámara de aire (Código)	Volumen interno al 75% (litros)	Profundidad de la banda de rodamiento (mm)		
42	480/80 R42 156A8/156B TL 18.4 R42	539386	489	1840	837	5470	DW16A	DD16 W16A	831	412	52		
Bar	0.4 0.6 0.8 1.0 1.2 1.4 1.6 1.8 2.0 2.2 2.4 2.6 2.8 3.0 3.2												
Psi	6 9 12 15 17 20 23 26 29 32 35 38 41 44 46												
10 km/h**	2325	2720	3115	3505	3900	4295	4690	5080	5475	5605	5740	5870	6000
30 km/h	1660	1980	2320	2655	2995	3345	3690	3855	4015	4150	4280		
40 km/h		1850	2180	2490	2800	3125	3450	3600	3750	3875	4000		
50 km/h		1850	2180	2490	2800	3125	3450	3600	3750	3875	4000		
40 km/h Dual	1365	1630	1920	2195	2465	2750	3035	3155	3280	3400	3520		

Ø Pulgadas	Descripción	CAI	S mm	D mm	R' mm	Cdr. mm	Llanta recomendada	Llanta permitida	Cámara de aire (Código)	Volumen interno al 75% (litros)	Profundidad de la banda de rodamiento (mm)		
42	520/85 R42 162A8/162B TL 20.8 R42	405859	542	1958	886	5810	DW18A	DD18 W18A	802	545	55		
Bar	0.4 0.6 0.8 1.0 1.2 1.4 1.6 1.8 2.0 2.2 2.4 2.6 2.8 3.0 3.2												
Psi	6 9 12 15 17 20 23 26 29 32 35 38 41 44 46												
10 km/h**	2775	3250	3725	4195	4670	5145	5620	6090	6565	6705	6845	6985	7125
30 km/h	1980	2395	2790	3190	3585	4000	4415	4615	4815	4950	5085		
40 km/h		2240	2575	2965	3350	3740	4125	4315	4500	4625	4750		
50 km/h		2240	2575	2965	3350	3740	4125	4315	4500	4625	4750		
40 km/h Dual	1630	1970	2265	2610	2950	3290	3630	3770	3905	4045	4180		

* Consultar las notas al final de las tablas de esta gama.

MICHELIN® AGRIBIB 2

Características y presiones en (Bar) y (Psi): carga por neumático en kg*

Ø Pulgadas	Descripción	CAI	S mm	D mm	R' mm	Cdr. mm	Llanta recomendada	Llanta permitida	Cámara de aire (Código)	Volumen interno al 75% (litros)	Profundidad de la banda de rodamiento (mm)
46	420/80 R46 151A8/151B TL	885138	418	1854	844	5524	DW13	DW12	835	334	50
Bar	0.4 0.6 0.8 1.0 1.2 1.4 1.6 1.8 2.0 2.2 2.4 2.6 2.8 3.0 3.2										
Psi	6 9 12 15 17 20 23 26 29 32 35 38 41 44 46										
10 km/h**	1980 2395 2815 3230 3645 3810 3975 4240 4500 4670 4840 5005 5175										
30 km/h	1410 1710 1980 2290 2600 2855 3105 3250 3400 3545 3690										
40 km/h	1600 1850 2140 2430 2665 2900 3040 3175 3315 3450										
50 km/h	1600 1850 2140 2430 2665 2900 3040 3175 3315 3450										
40 km/h Dual	1160 1410 1630 1885 2140 2345 2550 2670 2795 2915 3035										

Ø Pulgadas	Descripción	CAI	S mm	D mm	R' mm	Cdr. mm	Llanta recomendada	Llanta permitida	Cámara de aire (Código)	Volumen interno al 75% (litros)	Profundidad de la banda de rodamiento (mm)
46	480/80 R46 158A8/158B TL <i>18.4 R46</i>	622709	486	1945	891	5804	DW16A	DD16 DW16L W16A	834	449	52
Bar	0.4 0.6 0.8 1.0 1.2 1.4 1.6 1.8 2.0 2.2 2.4 2.6 2.8 3.0 3.2										
Psi	6 9 12 15 17 20 23 26 29 32 35 38 41 44 46										
10 km/h**	2475 2945 3415 3880 4350 4615 4875 5175 5475 5700 5925 6150 6375										
30 km/h	1765 2085 2460 2785 3105 3455 3800 3990 4175 4365 4550										
40 km/h	1950 2300 2600 2900 3225 3550 3725 3900 4075 4250										
50 km/h	1950 2300 2600 2900 3225 3550 3725 3900 4075 4250										
40 km/h Dual	1715 2025 2290 2550 2840 3125 3280 3435 3585 3740										

Ø Pulgadas	Descripción	CAI	S mm	D mm	R' mm	Cdr. mm	Llanta recomendada	Llanta permitida	Cámara de aire (Código)	Volumen interno al 75% (litros)	Profundidad de la banda de rodamiento (mm)
46	520/85 R46 164A8/164B TL <i>20.8 R46</i>	120922	518	2059	931	6110	DW16A	DW16L DW18A DW18L W16A W16L W18A W18L	834	560	55
Bar	0.4 0.6 0.8 1.0 1.2 1.4 1.6 1.8 2.0 2.2 2.4 2.6 2.8 3.0 3.2										
Psi	6 9 12 15 17 20 23 26 29 32 35 38 41 44 46										
10 km/h**	2925 3425 3930 4430 4935 5435 5935 6440 6940 7035 7130 7220 7315										
30 km/h	2085 2460 2870 3280 3690 4120 4550 4750 4950 5150 5350										
40 km/h	2300 2725 3090 3450 3850 4250 4440 4625 4815 5000										
50 km/h	2300 2725 3090 3450 3850 4250 4440 4625 4815 5000										
40 km/h Dual	1715 2025 2400 2720 3035 3390 3740 3905 4070 4235 4400										

* Consultar las notas al final de las tablas de esta gama.

MICHELIN® AGRIBIB 2

Características y presiones en (Bar) y (Psi): carga por neumático en kg*

Ø Pulgadas	Descripción	CAI	S mm	D mm	R' mm	Cdr. mm	Llanta recomendada	Llanta permitida	Cámara de aire (Código)	Volumen interno al 75% (litros)	Profundidad de la banda de rodamiento (mm)
50	480/80 R50 159A8/159B TL 18.4 R50	263049	465	2050	938	6116	DW15A	DW16A		483	52
Bar	0.4 0.6 0.8 1.0 1.2 1.4 1.6 1.8 2.0 2.2 2.4 2.6 2.8 3.0 3.2										
Psi	6 9 12 15 17 20 23 26 29 32 35 38 41 44 46										
10 km/h**	2550 3065 3585 4100 4615 4895 5175 5495 5815 6005 6190 6380 6565										
30 km/h	1820 2205 2525 2910 3290 3655 4015 4180 4350 4515 4680										
40 km/h	2060 2360 2720 3075 3415 3750 3905 4065 4220 4375										
50 km/h	2060 2360 2720 3075 3415 3750 3905 4065 4220 4375										
40 km/h Dual	1815 2075 2390 2705 3005 3300 3440 3575 3715 3850										

Ø Pulgadas	Descripción	CAI	S mm	D mm	R' mm	Cdr. mm	Llanta recomendada	Llanta permitida	Cámara de aire (Código)	Volumen interno al 75% (litros)	Profundidad de la banda de rodamiento (mm)
54	380/90 R54 152A8/152B TL	075615	386	2054	949	6129	W12A	DW13B		334	50
Bar	0.4 0.6 0.8 1.0 1.2 1.4 1.6 1.8 2.0 2.2 2.4 2.6 2.8 3.0 3.2										
Psi	6 9 12 15 17 20 23 26 29 32 35 38 41 44 46										
10 km/h**	2040 2470 2895 3325 3750 3920 4090 4410 4725 4875 5025 5175 5325										
30 km/h	1455 1765 2085 2380 2675 2945 3210 3360 3505 3655 3800										
40 km/h	1650 1950 2225 2500 2750 3000 3140 3275 3415 3550										
50 km/h	1650 1950 2225 2500 2750 3000 3140 3275 3415 3550										
40 km/h Dual	1450 1715 1960 2200 2420 2640 2760 2885 3005 3125										

***IMPORTANTE:**

La presión de inflado se determina siempre en función de la carga por neumático, de la velocidad y del trabajo a realizar. Las recomendaciones anteriores se facilitan con la salvedad de modificaciones posteriores a la fecha de difusión de estas tablas (junio de 2018). Los datos técnicos pueden sufrir modificaciones sin previo aviso.

- Para labranza y otras aplicaciones en las que se requiere un alto par motor, utilizar la línea de 30 km/h.
 - Cuando se utiliza la configuración de montaje simple (single):
 - Añadir 0.4 Bar para usar en pendientes superiores al 20%
 - Añadir 0.4 Bar para uso pesado en carreteras superiores al 50%
- **10 km/h LT (torque bajo) (velocidad máxima 10 km/h).



MICHELIN® AGRIBIB

**ALTOS NIVELES DE
RENDIMIENTO DURANTE
TODA SU VIDA ÚTIL**



Para tractores de 60 a 170 HP

y hasta 500HP con montaje gemelado (42", 46", 50")



Un nivel de **TRACCIÓN ÓPTIMO** durante toda su vida útil:

- +4%⁽¹⁾ de tracción en neumáticos nuevos
- +22%⁽¹⁾ de tracción en neumáticos al 60% de uso



DURACIÓN gracias a su banda de rodamiento con gajos profundos



ROBUSTEZ:

- Resistencia del casco radial demostrada
- Caucho resistente al daño



(1) Prueba analítica realizada en las pistas del Centro de Pruebas MICHELIN® (Ladoux): dimensión 18.4 R38.

DIMENSIONES

9.5 R24 112A8/109B TL	16.9 R28 141A8/138B TL	12.4 R36 124A8/121B TL	480/80 R42 156A8/156B TL
11.2 R24 119A8/116B TL	380/85 R30 135A8/135B TL	12.4 R38 131A8/128B TL	520/85 R42 157A8/157B TL
12.4 R24 119A8/116B TL	16.9 R30 137A8/134B TL	13.6 R38 128A8/125B TL	420/80 R46 151A8/148B TL
13.6 R24 124A8/121B TL	420/90 R30 147A8/147B TL	380/80 R38 142A8/139D TL	480/80 R46 158A8/158B TL
14.9 R24 130A8/127B TL	18.4 R30 142A8/139B TL	420/85 R38 144A8/144B TL	520/85 R46 158A8/155B TL
16.9 R24 134A8/131B TL	320/85 R34 133A8/130B TL	380/95 R38 147A8/147B TL	480/80 R50 159A8/159B TL
12.4 R28 126A8/123B TL	380/85 R34 137A8/137B TL	18.4 R38 151A8/148B TL	480/95 R50 164A8/164B TL
13.6 R28 123A8/120B TL	420/85 R34 147A8/147B TL	20.8 R38 159A8/156B TL	
14.9 R28 134A8/131B TL	18.4 R34 149A8/146B TL	520/85 R38 155A8/155B TL	

MICHELIN® AGRIBIB

Características y presiones en (Bar) y (Psi): carga por neumático en kg*

Ø Pulgadas	Descripción	CAI	S mm	D mm	R' mm	Cdr. mm	Llanta recomendada	Llanta permitida	Cámara de aire (Código)	Volumen interno al 75% (litros)	Profundidad de la banda de rodamiento (mm)
24	9.5 R24 112A8/109B TL	200987	253	1045	481	3117	W8	W7	686	65	32
Bar	0.4 0.5 0.6 0.8	1.0 1.2 1.4 1.6 1.8 2.0 2.1 2.3 2.4 2.6 2.8									
Psi	6 7 9 12 15 17 20 23 26 29 30 33 35 38 41										
10 km/h**	675 745 815 960	1100 1240 1280 1315 1395 1475 1515 1595	1635								
30 km/h	535 605 675 745	815 885 965 1045 1105 1170 1200									
40 km/h		630 695 760 825 900 975 1035 1090 1120									
50 km/h		575 640 710 775 830 885 940 995 1020									
40 km/h Dual	385 470 555 615	675 740 800 860 910 960 985									

Ø Pulgadas	Descripción	CAI	S mm	D mm	R' mm	Cdr. mm	Llanta recomendada	Llanta permitida	Cámara de aire (Código)	Volumen interno al 75% (litros)	Profundidad de la banda de rodamiento (mm)
24	11.2 R24 119A8/116B TL	317247	288	1095	503	3269	W10	W9	692	92	37
Bar	0.4 0.5 0.6 0.8	1.0 1.2 1.4 1.6 1.8 2.0 2.1 2.3 2.4 2.6 2.8									
Psi	6 7 9 12 15 17 20 23 26 29 30 33 35 38 41										
10 km/h**	840 925 1005 1170	1335 1500 1570 1635 1720 1810 1850 1935 1980									
30 km/h	660 745 830 910	990 1070 1170 1265 1340 1415 1455									
40 km/h		775 850 925 1000 1090 1180 1250 1325 1360									
50 km/h		705 780 860 935 1005 1075 1140 1205 1240									
40 km/h Dual	480 580 680 750	825 895 970 1040 1100 1165 1195									

Ø Pulgadas	Descripción	CAI	S mm	D mm	R' mm	Cdr. mm	Llanta recomendada	Llanta permitida	Cámara de aire (Código)	Volumen interno al 75% (litros)	Profundidad de la banda de rodamiento (mm)
24	12.4 R24 119A8/116B TL	123788	324	1149	520	3420	W11	W10	692	116	41
Bar	0.4 0.5 0.6 0.8	1.0 1.2 1.4 1.6 1.8 2.0 2.1 2.3 2.4 2.6 2.8									
Psi	6 7 9 12 15 17 20 23 26 29 30 33 35 38 41										
10 km/h**		1040 1200 1330 1460 1590 1715 1845 1975									
30 km/h		810 950 1050 1155 1255 1360 1460									
40 km/h		880 975 1070 1170 1265 1360									
50 km/h		830 915 1000 1080 1165 1250									

* Consultar las notas al final de las tablas de esta gama.

MICHELIN® AGRIBIB

Características y presiones en (Bar) y (Psi): carga por neumático en kg*

Ø Pulgadas	Descripción	CAI	S mm	D mm	R' mm	Cdr. mm	Llanta recomendada	Llanta permitida	Cámara de aire (Código)	Volumen interno al 75% (litros)	Profundidad de la banda de rodamiento (mm)				
24	13.6 R24 124A8/121B TL	262831	370	1200	551	3583	W12	W11	700	144	43				
Bar	0.4	0.5	0.6	0.8	1.0	1.2	1.4	1.6	1.8	2.0	2.1	2.3	2.4	2.6	2.8
Psi	6	7	9	12	15	17	20	23	26	29	30	33	35	38	41
10 km/h**	975	1075	1175	1375	1570	1770	1850	1930	2030	2130	2175	2275	2325		
15 km/h	870	955	1040	1220	1400	1580	1705	1830	1955	2080	2145				
30 km/h	760	865	965	1065	1165	1265	1385	1500	1585	1670	1710				
40 km/h			900	995	1085	1180	1290	1400	1480	1560	1600				
50 km/h			820	915	1010	1105	1190	1275	1345	1420	1455				
40 km/h Dual	555	675	790	880	965	1055	1140	1230	1300	1375	1410				
40 km/h FRT								1550	1680	1775	1825	1920	1960	2040	

Ø Pulgadas	Descripción	CAI	S mm	D mm	R' mm	Cdr. mm	Llanta recomendada	Llanta permitida	Cámara de aire (Código)	Volumen interno al 75% (litros)	Profundidad de la banda de rodamiento (mm)				
24	14.9 R24 130A8/127B TL	601563	397	1265	575	3769	W13	W11 W12	703	188	48				
Bar	0.4	0.5	0.6	0.8	1.0	1.2	1.4	1.6	1.8	2.0	2.1	2.3	2.4	2.6	2.8
Psi	6	7	9	12	15	17	20	23	26	29	30	33	35	38	41
10 km/h**	1165	1280	1400	1635	1865	2100	2175	2250	2380	2515	2580	2710	2775		
30 km/h	910	1040	1165	1275	1390	1500	1635	1765	1875	1980	2035				
40 km/h			1090	1195	1295	1400	1525	1650	1750	1850	1900				
50 km/h			990	1100	1210	1320	1410	1500	1590	1685	1730				
40 km/h Dual	660	810	960	1060	1155	1255	1350	1450	1540	1625	1670				

Ø Pulgadas	Descripción	CAI	S mm	D mm	R' mm	Cdr. mm	Llanta recomendada	Llanta permitida	Cámara de aire (Código)	Volumen interno al 75% (litros)	Profundidad de la banda de rodamiento (mm)				
24	16.9 R24 134A8/131B TL	123854	460	1330	586	3935	DW15L	DW14L W14L W15L	710	244	55				
Bar	0.4	0.5	0.6	0.8	1.0	1.2	1.4	1.6	1.8	2.0	2.1	2.3	2.4	2.6	2.8
Psi	6	7	9	12	15	17	20	23	26	29	30	33	35	38	41
10 km/h**		1620	1880	2080	2280	2480	2680	2880	3080						
30 km/h		1270	1470	1630	1790	1950	2110	2270							
40 km/h			1380	1530	1675	1825	1970	2120							
50 km/h			1290	1420	1555	1685	1820	1950							
40 km/h Dual	790	1005	1215	1345	1475	1605	1735	1865							

* Consultar las notas al final de las tablas de esta gama.

MICHELIN® AGRIBIB

Características y presiones en (Bar) y (Psi): carga por neumático en kg*

Ø Pulgadas	Descripción	CAI	S mm	D mm	R' mm	Cdr. mm	Llanta recomendada	Llanta permitida	Cámara de aire (Código)	Volumen interno al 75% (litros)	Profundidad de la banda de rodamiento (mm)
28	12.4 R28 126A8/123B TL	738964	322	1265	586	3778	W11	W10	726	134	40
Bar	0.4 0.5 0.6 0.8 1.0 1.2 1.4 1.6 1.8 2.0 2.1 2.3 2.4 2.6 2.8										
Psi	6 7 9 12 15 17 20 23 26 29 30 33 35 38 41										
10 km/h**	1035 1140 1245 1455 1665 1875 1960 2040 2150 2260 2310 2420 2475										
30 km/h	805 925 1045 1145 1240 1340 1475 1605 1690 1775 1820										
40 km/h	975 1065 1160 1250 1375 1500 1580 1660 1700										
50 km/h	885 980 1075 1170 1270 1365 1435 1510 1545										
40 km/h Dual	590 725 860 950 1045 1135 1230 1320 1390 1460 1495										

Ø Pulgadas	Descripción	CAI	S mm	D mm	R' mm	Cdr. mm	Llanta recomendada	Llanta permitida	Cámara de aire (Código)	Volumen interno al 75% (litros)	Profundidad de la banda de rodamiento (mm)
28	13.6 R28 123A8/120B TL	123782	372	1308	592	3893	W12	W11	732	173	46
Bar	0.4 0.5 0.6 0.8 1.0 1.2 1.4 1.6 1.8 2.0 2.1 2.3 2.4 2.6 2.8										
Psi	6 7 9 12 15 17 20 23 26 29 30 33 35 38 41										
10 km/h**	1190 1370 1520 1665 1815 1960 2110 2255										
30 km/h	930 1080 1195 1310 1430 1545 1660										
40 km/h	1010 1120 1225 1335 1440 1550										
50 km/h	920 1015 1110 1210 1305 1400										
40 km/h Dual	590 740 890 985 1080 1175 1270 1365										

Ø Pulgadas	Descripción	CAI	S mm	D mm	R' mm	Cdr. mm	Llanta recomendada	Llanta permitida	Cámara de aire (Código)	Volumen interno al 75% (litros)	Profundidad de la banda de rodamiento (mm)
28	14.9 R28 134A8/131B TL	112235	393	1365	624	4072	W13	W12	821	210	47
Bar	0.4 0.5 0.6 0.8 1.0 1.2 1.4 1.6 1.8 2.0 2.1 2.3 2.4 2.6 2.8										
Psi	6 7 9 12 15 17 20 23 26 29 30 33 35 38 41										
10 km/h**	1240 1365 1495 1745 2000 2250 2365 2475 2625 2775 2825 2925 2980 3080 3180										
30 km/h	885 980 1070 1230 1420 1605 1765 1925 2010 2100 2140 2225 2270										
40 km/h	1000 1150 1325 1500 1650 1800 1880 1960 2000 2080 2120										
50 km/h	910 1045 1205 1365 1505 1640 1715 1785 1820 1895 1930										

Ø Pulgadas	Descripción	CAI	S mm	D mm	R' mm	Cdr. mm	Llanta recomendada	Llanta permitida	Cámara de aire (Código)	Volumen interno al 75% (litros)	Profundidad de la banda de rodamiento (mm)
28	16.9 R28 141A8/138B TL	984997	454	1435	655	4278	DW15L	DW14L W14L W15L	822	272	51
Bar	0.4 0.5 0.6 0.8 1.0 1.2 1.4 1.6 1.8 2.0 2.1 2.3 2.4 2.6 2.8										
Psi	6 7 9 12 15 17 20 23 26 29 30 33 35 38 41										
10 km/h**	1500 1650 1800 2100 2400 2700 2850 3000 3180 3360 3425 3550 3615 3740 3865										
30 km/h	1070 1185 1300 1500 1715 1925 2130 2335 2440 2545 2600 2705 2755										
40 km/h	1215 1400 1600 1800 1990 2180 2280 2380 2425 2525 2575										
50 km/h	1105 1275 1460 1640 1815 1985 2075 2165 2210 2300 2345										

* Consultar las notas al final de las tablas de esta gama.

MICHELIN® AGRIBIB

Características y presiones en (Bar) y (Psi): carga por neumático en kg*

Ø Pulgadas	Descripción	CAI	S mm	D mm	R' mm	Cdr. mm	Llanta recomendada	Llanta permitida	Cámara de aire (Código)	Volumen interno al 75% (litros)	Profundidad de la banda de rodamiento (mm)				
30	380/85 R30 135A8/135B TL (14.9 R30)	836509	386	1416	628	4194	W12	W13		209	46				
Bar	0.4	0.5	0.6	0.8	1.0	1.2	1.4	1.6	1.8	2.0	2.1	2.3	2.4	2.6	2.8
Psi	6	7	9	12	15	17	20	23	26	29	30	33	35	38	41
10 km/h**	1450	1565	1680	1905	2135	2360	2580	2800	3100						
30 km/h	1060	1155	1250	1450	1675	1900	2100	2300							
40 km/h			1180	1360	1555	1750	1965	2180							
50 km/h			1180	1360	1550	1750	1965	2180							
40 km/h Dual	860	950	1040	1195	1370	1540	1730	1920							

Ø Pulgadas	Descripción	CAI	S mm	D mm	R' mm	Cdr. mm	Llanta recomendada	Llanta permitida	Cámara de aire (Código)	Volumen interno al 75% (litros)	Profundidad de la banda de rodamiento (mm)				
30	16.9 R30 137A8/134B TL	123870	447	1480	664	4395	DW15L	DW14L W14L W15L	754	285	49				
Bar	0.4	0.5	0.6	0.8	1.0	1.2	1.4	1.6	1.8	2.0	2.1	2.3	2.4	2.6	2.8
Psi	6	7	9	12	15	17	20	23	26	29	30	33	35	38	41
10 km/h**		1760	2040	2255	2475	2690	2910	3125	3340						
30 km/h		1380	1600	1770	1945	2115	2290	2460							
40 km/h			1500	1660	1820	1980	2140	2300							
50 km/h			1400	1545	1690	1830	1975	2120							
40 km/h Dual	880	1100	1320	1460	1600	1745	1885	2025							

Ø Pulgadas	Descripción	CAI	S mm	D mm	R' mm	Cdr. mm	Llanta recomendada	Llanta permitida	Cámara de aire (Código)	Volumen interno al 75% (litros)	Profundidad de la banda de rodamiento (mm)				
30	420/90 R30 147A8/147B TL	953332	443	1533	690	4556	DW13	DW14L W13 W14L	754	284	44				
Bar	0.4	0.5	0.6	0.8	1.0	1.2	1.4	1.6	1.8	2.0	2.1	2.3	2.4	2.6	2.8
Psi	6	7	9	12	15	17	20	23	26	29	30	33	35	38	41
10 km/h**	1800	1955	2110	2415	2725	3035	3340	3650	3950	4250	4315	4440	4500	4565	4625
30 km/h	1285	1420	1550	1800	2050	2300	2550	2800	2940	3075	3145	3280	3350		
40 km/h			1450	1700	1940	2175	2415	2650	2775	2900	2945	3030	3075		
50 km/h			1450	1700	1940	2175	2415	2650	2775	2900	2945	3030	3075		
40 km/h Dual	1070	1175	1275	1495	1705	1915	2120	2330	2440	2550	2590	2665	2705		

* Consultar las notas al final de las tablas de esta gama.

MICHELIN® AGRIBIB

Características y presiones en (Bar) y (Psi): carga por neumático en kg*

Ø Pulgadas	Descripción	CAI	S mm	D mm	R' mm	Cdr. mm	Llanta recomendada	Llanta permitida	Cámara de aire (Código)	Volumen interno al 75% (litros)	Profundidad de la banda de rodamiento (mm)
30	18.4 R30 142A8/139B TL	123844	504	1550	695	4602	DW16L	DW15L W15L W16L	757	353	54
Bar	0.4 0.5 0.6 0.8 1.0 1.2 1.4 1.6 1.8 2.0 2.1 2.3 2.4 2.6 2.8										
Psi	6 7 9 12 15 17 20 23 26 29 30 33 35 38 41										
10 km/h**	2030	2350	2600	2850	3100	3355	3605	3855			
30 km/h	1590	1840	2040	2240	2440	2640	2840				
40 km/h		1720	1905	2090	2280	2465	2650				
50 km/h		1600	1765	1930	2100	2265	2430				
40 km/h Dual	1040	1280	1515	1680	1840	2005	2165	2330			

Ø Pulgadas	Descripción	CAI	S mm	D mm	R' mm	Cdr. mm	Llanta recomendada	Llanta permitida	Cámara de aire (Código)	Volumen interno al 75% (litros)	Profundidad de la banda de rodamiento (mm)				
34	320/85 R34 133A8/130B TL (12.4 R34)	122760	320	1420	651	4239	W10			155	39				
Bar	0.4 0.5 0.6 0.8 1.0 1.2 1.4 1.6 1.8 2.0 2.1 2.3 2.4 2.6 2.8														
Psi	6 7 9 12 15 17 20 23 26 29 30 33 35 38 41														
10 km/h**	1215	1315	1410	1610	1805	2000	2215	2430	2615	2800	2835	2905	2940	3005	3075
30 km/h	850	940	1030	1215	1385	1550	1725	1900	1980	2060	2090	2150	2180		
40 km/h		975	1120	1285	1450	1600	1750	1850	1950	1980	2035	2060			
50 km/h		900	1030	1180	1320	1460	1600	1700	1800	1825	1875	1900			
40 km/h Dual	705	785	860	985	1130	1275	1410	1540	1630	1715	1740	1790	1815		

Ø Pulgadas	Descripción	CAI	S mm	D mm	R' mm	Cdr. mm	Llanta recomendada	Llanta permitida	Cámara de aire (Código)	Volumen interno al 75% (litros)	Profundidad de la banda de rodamiento (mm)
34	380/85 R34 137A8/137B TL (14.9 R34)	122781	394	1503	673	4461	W12	W13	704	230	44
Bar	0.4 0.5 0.6 0.8 1.0 1.2 1.4 1.6 1.8 2.0 2.1 2.3 2.4 2.6 2.8										
Psi	6 7 9 12 15 17 20 23 26 29 30 33 35 38 41										
10 km/h**	1550	1670	1790	2025	2265	2500	2750	3000	3300		
30 km/h	1120	1220	1320	1550	1775	2000	2215	2430			
40 km/h		1250	1450	1650	1850	2075	2300				
50 km/h		1250	1450	1650	1850	2075	2300				
40 km/h Dual	905	1005	1100	1275	1455	1630	1830	2025			

* Consultar las notas al final de las tablas de esta gama.

MICHELIN® AGRIBIB

Características y presiones en (Bar) y (Psi): carga por neumático en kg*

Ø Pulgadas	Descripción	CAI	S mm	D mm	R' mm	Cdr. mm	Llanta recomendada	Llanta permitida	Cámara de aire (Código)	Volumen interno al 75% (litros)	Profundidad de la banda de rodamiento (mm)
34	420/85 R34 147A8/147B TL (16.9 R34)	788910	455	1595	725	4751	DW15L	DW14L W13 W14L W15L	704	287	51
Bar	0.4 0.5 0.6 0.8 1.0 1.2 1.4 1.6 1.8 2.0 2.1 2.3 2.4 2.6 2.8										
Psi	6 7 9 12 15 17 20 23 26 29 30 33 35 38 41										
10 km/h**	1800 1940 2075 2350 2625 2900 3175 3450 3800 4045 4115 4260 4330 4475 4615										
30 km/h	1300 1430 1560 1815 2075 2330 2585 2835 2950 3065 3120 3235 3290										
40 km/h	1450 1695 1935 2180 2415 2650 2755 2865 2915 3020 3075										
50 km/h	1450 1695 1935 2180 2415 2650 2755 2865 2915 3020 3075										
40 km/h Dual	1280 1495 1705 1920 2125 2330 2425 2520 2570 2665 2710										

Ø Pulgadas	Descripción	CAI	S mm	D mm	R' mm	Cdr. mm	Llanta recomendada	Llanta permitida	Cámara de aire (Código)	Volumen interno al 75% (litros)	Profundidad de la banda de rodamiento (mm)
34	18.4 R34 149A8/146B TL	679786	491	1662	830	4940	DW16L	DW15L W15L W16L	823	395	54
Bar	0.4 0.5 0.6 0.8 1.0 1.2 1.4 1.6 1.8 2.0 2.1 2.3 2.4 2.6 2.8										
Psi	6 7 9 12 15 17 20 23 26 29 30 33 35 38 41										
10 km/h**	1980 2175 2370 2760 3150 3540 3705 3865 4080 4295 4405 4620 4725										
30 km/h	1550 1765 1980 2160 2345 2525 2760 2995 3190 3385 3480										
40 km/h	1850 2020 2190 2360 2580 2800 2980 3160 3250										
50 km/h	1685 1860 2035 2210 2380 2550 2715 2880 2960										
40 km/h Dual	1130 1380 1630 1795 1965 2130 2300 2465 2625 2780 2860										

Ø Pulgadas	Descripción	CAI	S mm	D mm	R' mm	Cdr. mm	Llanta recomendada	Llanta permitida	Cámara de aire (Código)	Volumen interno al 75% (litros)	Profundidad de la banda de rodamiento (mm)
36	12.4 R36 124A8/121B TL	123952	318	1460	673	4363	W11	W10	779	165	33
Bar	0.4 0.5 0.6 0.8 1.0 1.2 1.4 1.6 1.8 2.0 2.1 2.3 2.4 2.6 2.8										
Psi	6 7 9 12 15 17 20 23 26 29 30 33 35 38 41										
10 km/h**	1220 1420 1570 1720 1870 2025 2175 2325										
30 km/h	960 1110 1230 1350 1470 1590 1710										
40 km/h	1040 1150 1265 1375 1490 1600										
50 km/h	960 1060 1155 1255 1350 1450										

Ø Pulgadas	Descripción	CAI	S mm	D mm	R' mm	Cdr. mm	Llanta recomendada	Llanta permitida	Cámara de aire (Código)	Volumen interno al 75% (litros)	Profundidad de la banda de rodamiento (mm)
38	12.4 R38 131A8/128B TL	258138	325	1500	697	4484	W11	DW10W10	779	165	35
Bar	0.4 0.5 0.6 0.8 1.0 1.2 1.4 1.6 1.8 2.0 2.1 2.3 2.4 2.6 2.8										
Psi	6 7 9 12 15 17 20 23 26 29 30 33 35 38 41										
10 km/h**	1200 1315 1425 1650 1875 2100 2215 2325 2440 2550 2605 2720 2775										
30 km/h	935 1070 1200 1300 1400 1500 1660 1820 1925 2030 2085										
40 km/h	1120 1215 1305 1400 1550 1700 1800 1900 1950										
50 km/h	1020 1120 1220 1320 1435 1545 1635 1730 1775										
40 km/h Dual	680 835 985 1085 1190 1290 1395 1495 1585 1670 1715										

* Consultar las notas al final de las tablas de esta gama.

MICHELIN® AGRIBIB

Características y presiones en (Bar) y (Psi): carga por neumático en kg*

Ø Pulgadas	Descripción	CAI	S mm	D mm	R' mm	Cdr. mm	Llanta recomendada	Llanta permitida	Cámara de aire (Código)	Volumen interno al 75% (litros)	Profundidad de la banda de rodamiento (mm)
38	13.6 R38 128A8/125B TL	123992	358	1565	722	4705	DW12	W11 W12	795	218	45
Bar	0.4 0.5 0.6 0.8 1.0 1.2 1.4 1.6 1.8 2.0 2.1 2.3 2.4 2.6 2.8										
Psi	6 7 9 12 15 17 20 23 26 29 30 33 35 38 41										
10 km/h**	1380	1590	1760	1930	2100	2275	2445	2615			
30 km/h	1080	1250	1385	1520	1660	1795	1930				
40 km/h		1030	1140	1250	1365	1475	1585				
50 km/h		1090	1200	1315	1425	1540	1650				
40 km/h Dual	685 860	1030	1140	1250	1365	1475	1585				

Ø Pulgadas	Descripción	CAI	S mm	D mm	R' mm	Cdr. mm	Llanta recomendada	Llanta permitida	Cámara de aire (Código)	Volumen interno al 75% (litros)	Profundidad de la banda de rodamiento (mm)
38	380/80 R38 142A8/139D TL	667404	380	1578	723	4709	DW12A	DW12 DW13 W12 W13	795 796	230	46
Bar	0.4 0.5 0.6 0.8 1.0 1.2 1.4 1.6 1.8 2.0 2.1 2.3 2.4 2.6 2.8										
Psi	6 7 9 12 15 17 20 23 26 29 30 33 35 38 41										
10 km/h**	1545 1680	1815	2085	2360	2630	2900	3170	3345	3525 3610	3785	3875 3940 4000
30 km/h	1100 1215	1325	1555	1780	2005	2235	2460	2555	2650 2695	2790	2835
40 km/h		1250	1460	1670	1880	2090	2300	2390	2475 2520	2605	2650
50 km/h		975	1130	1285	1440	1595	1750	1920	2090 2175	2345	2430
65 km/h		975	1130	1285	1440	1595	1750	1920	2090 2175	2345	2430
40 km/h Dual	905 1000	1090	1280	1465	1650	1840	2025	2100	2180 2215	2290	2330

Ø Pulgadas	Descripción	CAI	S mm	D mm	R' mm	Cdr. mm	Llanta recomendada	Llanta permitida	Cámara de aire (Código)	Volumen interno al 75% (litros)	Profundidad de la banda de rodamiento (mm)
38	420/85 R38 144A8/144B TL (16.9 R38)	607820	455	1676	750	4975	DW15L	DW14L W14L W15L	786	311	51
Bar	0.4 0.5 0.6 0.8 1.0 1.2 1.4 1.6 1.8 2.0 2.1 2.3 2.4 2.6 2.8										
Psi	6 7 9 12 15 17 20 23 26 29 30 33 35 38 41										
10 km/h**	1900 2045	2190	2485	2775	3065	3360	3650	4015			
30 km/h	1375 1510	1645	1915	2190	2460	2730	3000				
40 km/h		1550	1800	2050	2300	2550	2800				
50 km/h		1550	1800	2050	2300	2550	2800				
40 km/h Dual	1130 1240	1355	1575	1800	2020	2245	2465				
Máx. 40 km/h FRT			2160	2460	2760	3060	3360				

* Consultar las notas al final de las tablas de esta gama.

MICHELIN® AGRIBIB

Características y presiones en (Bar) y (Psi): carga por neumático en kg*

Ø Pulgadas	Descripción	CAI	S mm	D mm	R' mm	Cdr. mm	Llanta recomendada	Llanta permitida	Cámara de aire (Código)	Volumen interno al 75% (litros)	Profundidad de la banda de rodamiento (mm)
38	380/95 R38 147A8/147B TL	836033	392	1689	769	5034	W12	W13	795	286	47
Bar	0.4 0.5 0.6 0.8 1.0 1.2 1.4 1.6 1.8 2.0 2.1 2.3 2.4 2.6 2.8										
Psi	6 7 9 12 15 17 20 23 26 29 30 33 35 38 41										
10 km/h**	1825 1980 2130 2440 2745 3055 3360 3670 3975 4100 4165 4295 4355 4485 4610										
30 km/h	1300 1430 1555 1810 2070 2325 2580 2835 2950 3065 3120 3235 3290										
40 km/h	1450 1690 1930 2170 2410 2650 2755 2865 2915 3020 3075										
50 km/h	1450 1690 1930 2170 2410 2650 2755 2865 2915 3020 3075										
40 km/h Dual	1070 1150 1235 1395 1560 1725 1890 2050 2215 2380 2460 2625 2705										

Ø Pulgadas	Descripción	CAI	S mm	D mm	R' mm	Cdr. mm	Llanta recomendada	Llanta permitida	Cámara de aire (Código)	Volumen interno al 75% (litros)	Profundidad de la banda de rodamiento (mm)
38	18.4 R38 151A8/148B TL	100097	494	1770	808	5267	DW16L	DW15L W15L W16L	824	431	54
Bar	0.4 0.5 0.6 0.8 1.0 1.2 1.4 1.6 1.8 2.0 2.1 2.3 2.4 2.6 2.8										
Psi	6 7 9 12 15 17 20 23 26 29 30 33 35 38 41										
10 km/h**	2100 2305 2515 2925 3340 3750 3920 4090 4325 4560 4675 4910 5025										
30 km/h	1660 1875 2085 2280 2480 2675 2945 3210 3400 3595 3690										
40 km/h	1950 2135 2315 2500 2750 3000 3180 3360 3450										
50 km/h	1775 1965 2155 2345 2540 2730 2895 3060 3140										
40 km/h Dual	1195 1455 1715 1900 2085 2270 2455 2640 2800 2955 3035										

Ø Pulgadas	Descripción	CAI	S mm	D mm	R' mm	Cdr. mm	Llanta recomendada	Llanta permitida	Cámara de aire (Código)	Volumen interno al 75% (litros)	Profundidad de la banda de rodamiento (mm)
38	20.8 R38 159A8/156B TL	813266	541	1850	837	5506	DW18L	DW16L W16L W18L	825	524	57
Bar	0.4 0.5 0.6 0.8 1.0 1.2 1.4 1.6 1.8 2.0 2.1 2.3 2.4 2.6 2.8										
Psi	6 7 9 12 15 17 20 23 26 29 30 33 35 38 41										
10 km/h**	2550 2810 3065 3585 4100 4615 4895 5175 5495 5815 5910 6095 6190 6380 6565										
30 km/h	1820 2015 2205 2525 2910 3290 3655 4015 4180 4350 4430 4595 4680										
40 km/h	2060 2360 2720 3075 3415 3750 3905 4065 4140 4295 4375										
50 km/h	1875 2150 2475 2800 3110 3415 3555 3700 3770 3910 3980										
40 km/h Dual	1810 2075 2390 2705 3005 3300 3440 3575 3645 3780 3850										

* Consultar las notas al final de las tablas de esta gama.

MICHELIN® AGRIBIB

Características y presiones en (Bar) y (Psi): carga por neumático en kg*

Ø Pulgadas	Descripción	CAI	S mm	D mm	R' mm	Cdr. mm	Llanta recomendada	Llanta permitida	Cámara de aire (Código)	Volumen interno al 75% (litros)	Profundidad de la banda de rodamiento (mm)
38	520/85 R38 155A8/155B TL (20.8 R38)	303668	530	1855	821	5529	DW16L	DD16 DD18 DW16A W16A W18A	825	509	51
Bar	0.4 0.5 0.6 0.8 1.0 1.2 1.4 1.6 1.8 2.0 2.1 2.3 2.4 2.6 2.8										
Psi	6 7 9 12 15 17 20 23 26 29 30 33 35 38 41										
10 km/h**	2650 2850 3050 3450 3850 4250 4625 5000 5535										
30 km/h	1900 2100 2300 2650 3050 3450 3790 4125										
40 km/h	2120 2500 2825 3150 3515 3875										
50 km/h	2120 2500 2800 3160 3515 3875										
40 km/h Dual	1540 1705 1865 2200 2485 2770 3090 3410										
Máx. 40 km/h FRT	3000 3415 3825 4240 4650										

Ø Pulgadas	Descripción	CAI	S mm	D mm	R' mm	Cdr. mm	Llanta recomendada	Llanta permitida	Cámara de aire (Código)	Volumen interno al 75% (litros)	Profundidad de la banda de rodamiento (mm)
42	480/80 R42 156A8/156B TL (18.4 R42)	404096	494	1858	847	5538	DW16A	DD16 W16A	801	420	55
Bar	0.4 0.5 0.6 0.8 1.0 1.2 1.4 1.6 1.8 2.0 2.1 2.3 2.4 2.6 2.8										
Psi	6 7 9 12 15 17 20 23 26 29 30 33 35 38 41										
10 km/h**	2325 2505 2690 3050 3415 3775 4140 4500 4750 5000 5125 5375 5500 5750 6000										
30 km/h	1660 1830 2000 2335 2675 3015 3350 3690 3840 3985 4060 4205 4280										
40 km/h	1850 2170 2490 2810 3130 3450 3590 3725 3795 3930 4000										
50 km/h	1850 2170 2490 2810 3130 3450 3590 3725 3795 3930 4000										
40 km/h Dual	1320 1465 1605 1890 2180 2465 2750 3035 3155 3280 3340 3460 3520										
Máx. 40 km/h FRT	2600 2955 3315 3670 4030 4385 4455 4595 4660 4800										

Ø Pulgadas	Descripción	CAI	S mm	D mm	R' mm	Cdr. mm	Llanta recomendada	Llanta permitida	Cámara de aire (Código)	Volumen interno al 75% (litros)	Profundidad de la banda de rodamiento (mm)
42	520/85 R42 157A8/157B TL (20.8 R42)	122791	539	1945	869	5771	DW18A	DD18 W18A	802	545	59
Bar	0.4 0.5 0.6 0.8 1.0 1.2 1.4 1.6 1.8 2.0 2.1 2.3 2.4 2.6 2.8										
Psi	6 7 9 12 15 17 20 23 26 29 30 33 35 38 41										
10 km/h**	2800 3015 3225 3650 4075 4500 4900 5300 5865										
30 km/h	2000 2180 2360 2800 3175 3550 3965 4375										
40 km/h	2240 2575 2965 3350 3740 4125										
50 km/h	2240 2575 3000 3350 3740 4125										
40 km/h Dual	1630 1800 1970 2265 2610 2950 3290 3630										
Máx. 40 km/h FRT	3090 3555 4020 4485 4950										

* Consultar las notas al final de las tablas de esta gama.

MICHELIN® AGRIBIB

Características y presiones en (Bar) y (Psi): carga por neumático en kg*

Ø Pulgadas	Descripción	CAI	S mm	D mm	R' mm	Cdr. mm	Llanta recomendada	Llanta permitida	Cámara de aire (Código)	Volumen interno al 75% (litros)	Profundidad de la banda de rodamiento (mm)
46	420/80 R46 151A8/148B TL	122770	410	1872	861	5555	DW13	DW12	835	334	51
Bar	0.4 0.5 0.6 0.8 1.0 1.2 1.4 1.6 1.8 2.0 2.1 2.3 2.4 2.6 2.8										
Psi	6 7 9 12 15 17 20 23 26 29 30 33 35 38 41										
10 km/h**	2000 2170 2340 2675 3015 3350 3675 4000 4315 4625 4720 4905 5000 5075 5150										
30 km/h	1450 1575 1700 2000 2290 2575 2865 3150 3300 3450 3500 3600 3650										
40 km/h	1600 1850 2140 2430 2665 2900 3075 3250 3300 3400 3450										
50 km/h	1450 1700 1950 2240 2445 2650 2800 3000 3040 3115 3150										
40 km/h Dual	1160 1285 1410 1630 1885 2140 2345 2550 2705 2860 2905 2990 3035										

Ø Pulgadas	Descripción	CAI	S mm	D mm	R' mm	Cdr. mm	Llanta recomendada	Llanta permitida	Cámara de aire (Código)	Volumen interno al 75% (litros)	Profundidad de la banda de rodamiento (mm)
46	480/80 R46 158A8/158B TL (18.4 R46)	637231	499	1948	889	5874	DW16A	DD16 DW16L W16A	834	449	54
Bar	0.4 0.5 0.6 0.8 1.0 1.2 1.4 1.6 1.8 2.0 2.1 2.3 2.4 2.6 2.8										
Psi	6 7 9 12 15 17 20 23 26 29 30 33 35 38 41										
10 km/h**	2475 2675 2875 3275 3675 4075 4475 4875 5125 5375 5500 5755 5880 6130 6380										
30 km/h	1770 1940 2110 2445 2785 3125 3460 3800 3990 4175 4270 4455 4550										
40 km/h	1950 2270 2590 2910 3230 3550 3725 3900 3990 4165 4250										
50 km/h	1950 2270 2590 2910 3230 3550 3725 3900 3990 4165 4250										
40 km/h Dual	1450 1585 1715 1940 2165 2390 2615 2840 3065 3290 3405 3630 3740										
Máx. 40 km/h FRT	2725 3095 3465 3830 4200 4570 4660 4835 4925 5100										

Ø Pulgadas	Descripción	CAI	S mm	D mm	R' mm	Cdr. mm	Llanta recomendada	Llanta permitida	Cámara de aire (Código)	Volumen interno al 75% (litros)	Profundidad de la banda de rodamiento (mm)
46	520/85 R46 158A8/155B TL (20.8 R46)	122780	515	2050	920	6088	DW16A	DW16L DW18A DW18L W16A W16L W18A W18L	834	581	58
Bar	0.4 0.5 0.6 0.8 1.0 1.2 1.4 1.6 1.8 2.0 2.1 2.3 2.4 2.6 2.8										
Psi	6 7 9 12 15 17 20 23 26 29 30 33 35 38 41										
10 km/h**	2900 3115 3325 3750 4175 4600 5025 5450 6070										
30 km/h	2090 2295 2500 2910 3320 3730 4140 4550										
40 km/h	2300 2690 3080 3470 3860 4250										
50 km/h	2120 2470 2820 3175 3525 3875										
40 km/h Dual	1715 1885 2055 2390 2730 3065 3400 3740										
Máx. 40 km/h FRT	3230 3700 4165 4635 5100										

* Consultar las notas al final de las tablas de esta gama.

MICHELIN® AGRIBIB

Características y presiones en (Bar) y (Psi): carga por neumático en kg*

Ø Pulgadas	Descripción	CAI	S mm	D mm	R' mm	Cdr. mm	Llanta recomendada	Llanta permitida	Cámara de aire (Código)	Volumen interno al 75% (litros)	Profundidad de la banda de rodamiento (mm)				
50	480/80 R50 159A8/159B TL	471947	474	2056	942	6135	DW15A	DW16A		479	56				
Bar	0.4	0.5	0.6	0.8	1.0	1.2	1.4	1.6	1.8	2.0	2.1	2.3	2.4	2.6	2.8
Psi	6	7	9	12	15	17	20	23	26	29	30	33	35	38	41
10 km/h**	2575	2785	2995	3415	3830	4250	4700	5150	5575	6000	6075	6225	6300	6400	6500
30 km/h	1800	1990	2180	2575	2915	3250	3625	4000	4190	4375	4440	4565	4625		
40 km/h			2060	2360	2720	3075	3415	3750	3940	4125	4190	4315	4375		
50 km/h			2060	2360	2725	3075	3415	3750	3875	4125	4190	4315	4375		
40 km/h Dual	1495	1655	1815	2075	2390	2705	3005	3300	3465	3630	3685	3795	3850		
Máx. 40 km/h FRT					2830	3230	3635	4035	4440	4840	4910	5045	5115	5250	

Ø Pulgadas	Descripción	CAI	S mm	D mm	R' mm	Cdr. mm	Llanta recomendada	Llanta permitida	Cámara de aire (Código)	Volumen interno al 75% (litros)	Profundidad de la banda de rodamiento (mm)				
50	480/95 R50 164A8/164B TL	491183	515	2175	992	6484	DW16B (A)	DW15B (A)		593	53				
Bar	0.4	0.5	0.6	0.8	1.0	1.2	1.4	1.6	1.8	2.0	2.1	2.3	2.4	2.6	2.8
Psi	6	7	9	12	15	17	20	23	26	29	30	33	35	38	41
10 km/h**	2925	3100	3270	3780	4285	4795	5300	5810	6185	6560	6750	7125	7310	7405	7500
30 km/h	2085	2305	2525	2955	3385	3820	4250	4680	4850	5015	5100	5265	5350		
40 km/h			2360	2765	3165	3570	3970	4375	4530	4690	4765	4920	5000		
50 km/h			2360	2765	3165	3570	3970	4375	4530	4690	4765	4920	5000		
40 km/h Dual	1720	1900	2080	2435	2790	3140	3495	3850	3990	4125	4195	4330	4400		
Máx. 40 km/h FRT					3320	3760	4205	4645	5090	5530	5610	5765	5845	6000	

***IMPORTANTE:**

La presión de inflado se determina siempre en función de la carga por neumático, de la velocidad y del trabajo a realizar. Las recomendaciones anteriores se facilitan con la salvedad de modificaciones posteriores a la fecha de difusión de estas tablas (junio de 2018). Los datos técnicos pueden sufrir modificaciones sin previo aviso.

- Para labranza y otras aplicaciones en las que se requiere un alto par motor, utilizar la línea de 20 mph.
- Cuando se utiliza la configuración de montaje simple (single):
 - Añadir 6 Psi para usar en pendientes superiores al 20%
 - Añadir 6 Psi para uso pesado en carreteras, superiores al 50%
- **10 km/h LT (torque bajo) (velocidad máxima 10 km/h).
- FRT: Neumático de Rodamiento Libre.



MICHELIN® CEREXBIB 2

MAYOR PRODUCTIVIDAD
Y SUELOS MÁS PROTEGIDOS



PARA MÁQUINAS COSECHADORAS GRANDES



Neumático CFO+

- Mayor capacidad de carga a 10 km/h de forma cíclica en los campos
- -45% de presión frente a un neumático estándar⁽¹⁾



MEJOR RENDIMIENTO

- +4% al año⁽²⁾



PROTECCIÓN A LOS SUELOS

- Baja presión sobre el campo



TRACCIÓN Y FLOTACIÓN

(1) Para 12,000 kg, estudio realizado en el neumático con la dimensión 900/60 R32 (2) Universidad Harper Adams 2014/2016.

DIMENSIONES

VF 520/80 R26 CFO+ 168A8 TL **NUEVO**
VF 620/70 R26 CFO+ 173A8 TL **NUEVO**
VF 750/65 R26 CFO+ 180A8 TL **NUEVO**
VF 620/70 R30 CFO+ 175A8 TL **NUEVO**
VF 520/85 R30 CFO+ 172A8 TL **NUEVO**
VF 710/65 R30 CFO+ 179A8 TL **NUEVO**

IF 800/65 R32 CFO+ 181A8 TL **NUEVO**
VF 900/60 R32 CFO+ 191A8 TL **NUEVO**
IF 800/70 R32 CFO+ 185A8 TL **NUEVO**
VF 500/85 R34 CFO+ 172A8 TL **NUEVO**
IF 680/80 R38 CFO+ 182A8 TL **NUEVO**
VF 900/60 R38 CFO+ 193A8 TL **NUEVO**

IF 800/70 R38 CFO+ 187A8 TL **NUEVO**
VF 520/85 R42 CFO+ 177A8 TL **NUEVO**
VF 580/85 R42 CFO+ 183A8 TL **NUEVO**
VF 710/70 R42 CFO+ 188A8 TL **NUEVO**
IF 800/70 R42 CFO+ 189A8 TL **NUEVO**
VF 900/60 R42 CFO+ 195A8 TL **NUEVO**

MICHELIN® CEREXBIB 2

Características y presiones en (Bar) y (Psi): carga por neumático en kg*

Ø Pulgadas	Descripción	CAI	S mm	D mm	R' mm	Cdr. mm	Llanta recomendada	Llanta permitida	Cámara de aire (Código)	Volumen interno al 75% (litros)	Profundidad de la banda de rodamiento (mm)
26	VF 520/80 R26 CFO+ 168A8 TL NUEVO	850494	503	1491	649	4400	DW16L	DW18L W16L	716	366	44
Bar	1.2 1.4 1.6	1.7 1.8 1.9 2.0	2.1 2.2 2.3 2.4	2.5 2.6 2.7 2.8							
Psi	17 20 23	25 26 28 29	30 32 33 35	36 38 39 41							
10 km/h Cyc	5230 5805 6375	6510 6645 6775	6910 7045 7175	7310 7440 7600	7760 7915 8075						
15 km/h Cyc	4765 5290 5815	5935 6060 6180	6300 6420 6540	6660 6780 6925	7075 7220 7365						
40 km/h	3550 3965 4375	4470 4570 4665	4760 4860 4955	5055 5150 5265	5375 5490 5600						

Ø Pulgadas	Descripción	CAI	S mm	D mm	R' mm	Cdr. mm	Llanta recomendada	Llanta permitida	Cámara de aire (Código)	Volumen interno al 75% (litros)	Profundidad de la banda de rodamiento (mm)
26	VF 620/70 R26 CFO+ 173A8 TL NUEVO	228272	606	1513	655	4461	DW20B (A)		716	463	45
Bar	1.2 1.4 1.6	1.7 1.8 1.9 2.0	2.1 2.2 2.3 2.4	2.5 2.6 2.7 2.8							
Psi	17 20 23	25 26 28 29	30 32 33 35	36 38 39 41							
10 km/h Cyc	6035 6740 7440	7605 7770 7935	8100 8265 8430	8590 8755 8945	9140 9330 9520						
15 km/h Cyc	5505 6145 6780	6930 7080 7230	7380 7530 7685	7835 7985 8160	8335 8505 8680						
40 km/h	4125 4640 5150	5255 5365 5470	5575 5680 5790	5895 6000 6125	6250 6375 6500						

Ø Pulgadas	Descripción	CAI	S mm	D mm	R' mm	Cdr. mm	Llanta recomendada	Llanta permitida	Cámara de aire (Código)	Volumen interno al 75% (litros)	Profundidad de la banda de rodamiento (mm)
26	VF 750/65 R26 CFO+ 180A8 TL NUEVO	132266	748	1623	701	4786	DW25B (A)		833	659	48
Bar	1.2 1.4 1.6	1.7 1.8 1.9 2.0	2.1 2.2 2.3 2.4	2.5 2.6 2.7 2.8							
Psi	17 20 23	25 26 28 29	30 32 33 35	36 38 39 41							
10 km/h Cyc	7440 8225 9010	9225 9435 9650	9860 10075 10285	10500 10710 10965	11220 11475 11730						
15 km/h Cyc	6780 7500 8215	8410 8605 8795	8990 9185 9380	9570 9765 10000	10230 10465 10695						
40 km/h	5150 5650 6150	6295 6440 6580	6725 6870 7015	7155 7300 7475	7650 7825 8000						

Ø Pulgadas	Descripción	CAI	S mm	D mm	R' mm	Cdr. mm	Llanta recomendada	Llanta permitida	Cámara de aire (Código)	Volumen interno al 75% (litros)	Profundidad de la banda de rodamiento (mm)
30	VF 620/70 R30 CFO+ 175A8 TL NUEVO	049288	608	1615	700	4765	DW20B (A)		737	506	43
Bar	1.2 1.4 1.6	1.7 1.8 1.9 2.0	2.1 2.2 2.3 2.4	2.5 2.6 2.7 2.8							
Psi	17 20 23	25 26 28 29	30 32 33 35	36 38 39 41							
10 km/h Cyc	6375 7120 7865	8040 8215 8390	8565 8740 8915	9090 9265 9500	9735 9965 10200						
15 km/h Cyc	5815 6495 7170	7330 7490 7650	7810 7970 8130	8290 8450 8665	8875 9090 9300						
40 km/h	4500 4975 5450	5555 5665 5770	5875 5980 6090	6195 6300 6450	6600 6750 6900						

* Consultar las notas al final de las tablas de esta gama.

MICHELIN® CEREXBIB 2

Características y presiones en (Bar) y (Psi): carga por neumático en kg*

Ø Pulgadas	Descripción	CAI	S mm	D mm	R' mm	Cdr. mm	Llanta recomendada	Llanta permitida	Cámara de aire (Código)	Volumen interno al 75% (litros)	Profundidad de la banda de rodamiento (mm)
30	VF 520/85 R30 CFO+ 172A8 TL NUEVO	188276	522	1624	709	4797	W16L		737	435	46
Bar	1.2 1.4 1.6 1.7 1.8 1.9 2.0 2.1 2.2 2.3 2.4 2.5 2.6 2.7 2.8										
Psi	17 20 23 25 26 28 29 30 32 33 35 36 38 39 41										
10 km/h Cyc	5865 6545 7225 7360 7495 7625 7760 7895 8025 8160 8290 8535 8780 9020 9265										
15 km/h Cyc	5350 5970 6590 6710 6830 6950 7070 7190 7315 7435 7555 7780 8005 8225 8450										
40 km/h	4000 4440 4875 4990 5110 5225 5340 5455 5570 5685 5800 5925 6050 6175 6300										

Ø Pulgadas	Descripción	CAI	S mm	D mm	R' mm	Cdr. mm	Llanta recomendada	Llanta permitida	Cámara de aire (Código)	Volumen interno al 75% (litros)	Profundidad de la banda de rodamiento (mm)
30	VF 710/65 R30 CFO+ 179A8 TL NUEVO	608814	694	1676	735	4952	DW25B (A)	DW23B (A)		630	46
Bar	1.2 1.4 1.6 1.7 1.8 1.9 2.0 2.1 2.2 2.3 2.4 2.5 2.6 2.7 2.8										
Psi	17 20 23 25 26 28 29 30 32 33 35 36 38 39 41										
10 km/h Cyc	7225 7990 8755 8970 9180 9395 9605 9820 10030 10245 10455 10690 10925 11155 11390										
15 km/h Cyc	6590 7290 7985 8180 8375 8565 8760 8955 9150 9340 9535 9750 9960 10175 10385										
40 km/h	5000 5500 6000 6140 6275 6415 6550 6690 6825 6965 7100 7265 7425 7590 7750										

Ø Pulgadas	Descripción	CAI	S mm	D mm	R' mm	Cdr. mm	Llanta recomendada	Llanta permitida	Cámara de aire (Código)	Volumen interno al 75% (litros)	Profundidad de la banda de rodamiento (mm)
32	IF 800/65 R32 CFO+ 181A8 TL NUEVO	987406	772	1855	826	5501	DW27B (A)		831	903	57
Bar	1.2 1.4 1.6 1.7 1.8 1.9 2.0 2.1 2.2 2.3 2.4 2.5 2.6 2.7 2.8										
Psi	17 20 23 25 26 28 29 30 32 33 35 36 38 39 41										
10 km/h Cyc	9010 9860 10710 10965 11220 11475 11730 11985 12240 12495 12750 13070 13390 13705 14025										
15 km/h Cyc	8215 8990 9765 10000 10230 10465 10695 10930 11160 11395 11625 11915 12210 12500 12790										
40 km/h	5300 5800 6300 6450 6600 6750 6900 7050 7200 7350 7500 7690 7875 8065 8250										

Ø Pulgadas	Descripción	CAI	S mm	D mm	R' mm	Cdr. mm	Llanta recomendada	Llanta permitida	Cámara de aire (Código)	Volumen interno al 75% (litros)	Profundidad de la banda de rodamiento (mm)
32	VF 900/60 R32 CFO+ 191A8 TL NUEVO	430737	856	1906	827	5618	DW27B (A)	DW30B (A)	831	1033	58
Bar	1.2 1.4 1.6 1.7 1.8 1.9 2.0 2.1 2.2 2.3 2.4 2.5 2.6 2.7 2.8										
Psi	17 20 23 25 26 28 29 30 32 33 35 36 38 39 41										
10 km/h Cyc	9860 10965 12070 12370 12665 12965 13260 13560 13855 14155 14450 14770 15090 15405 15725										
15 km/h Cyc	8990 10000 11005 11275 11550 11820 12090 12360 12635 12905 13175 13465 13760 14050 14340										
40 km/h	6700 7475 8250 8470 8690 8905 9125 9345 9565 9780 10000 10225 10450 10675 10900										

* Consultar las notas al final de las tablas de esta gama.

MICHELIN® CEREXBIB 2

Características y presiones en (Bar) y (Psi): carga por neumático en kg*

Ø Pulgadas	Descripción	CAI	S mm	D mm	R' mm	Cdr. mm	Llanta recomendada	Llanta permitida	Cámara de aire (Código)	Volumen interno al 75% (litros)	Profundidad de la banda de rodamiento (mm)
32	IF 800/70 R32 CFO+ 185A8 TL NUEVO	789156	796	1950	864	5800	DW27B (A)		831	966	55
Bar	1.2 1.4 1.6	1.7 1.8 1.9	2.0 2.1 2.2	2.3 2.4 2.5	2.6 2.7 2.8						
Psi	17 20 23	25 26 28	29 30 32	33 35 36	38 39 41						
10 km/h Cyc	9860 10965 12070	12370 12665 12965	13260 13560 13855	14155 14450 14770	15090 15405 15725						
15 km/h Cyc	8990 10000 11005	11275 11550 11820	12090 12360 12635	12905 13175 13465	13760 14050 14340						
40 km/h	5800 6450 7100	7275 7450 7625	7800 7975 8150	8325 8500 8690	8875 9065 9250						

Ø Pulgadas	Descripción	CAI	S mm	D mm	R' mm	Cdr. mm	Llanta recomendada	Llanta permitida	Cámara de aire (Código)	Volumen interno al 75% (litros)	Profundidad de la banda de rodamiento (mm)
34	VF 500/85 R34 CFO+ 172A8 TL NUEVO	038009	497	1676	741	4961	DW16L	DW18L		431	46
Bar	1.2 1.4 1.6	1.7 1.8 1.9	2.0 2.1 2.2	2.3 2.4 2.5	2.6 2.7 2.8						
Psi	17 20 23	25 26 28	29 30 32	33 35 36	38 39 41						
10 km/h Cyc	5870 6445 7020	7180 7340 7495	7655 7815 7975	8130 8290 8470	8650 8830 9010						
15 km/h Cyc	5350 5875 6400	6545 6690 6835	6980 7125 7270	7415 7560 7725	7890 8055 8220						
40 km/h	4000 4440 4875	4965 5060 5150	5240 5330 5420	5510 5600 5775	5950 6125 6300						

Ø Pulgadas	Descripción	CAI	S mm	D mm	R' mm	Cdr. mm	Llanta recomendada	Llanta permitida	Cámara de aire (Código)	Volumen interno al 75% (litros)	Profundidad de la banda de rodamiento (mm)
38	IF 680/80 R38 CFO+ 182A8 TL NUEVO	953912	646	2020	904	6030	DW21B	DW23B (A)	804	877	59
Bar	1.2 1.4 1.6	1.7 1.8 1.9	2.0 2.1 2.2	2.3 2.4 2.5	2.6 2.7 2.8						
Psi	17 20 23	25 26 28	29 30 32	33 35 36	38 39 41						
10 km/h Cyc	9265 10330 11390	11615 11835 12060	12285 12505 12730	12950 13175 13495	13815 14130 14450						
15 km/h Cyc	8450 9420 10385	10590 10795 10995	11200 11405 11610	11810 12015 12305	12595 12885 13175						
30 km/h Cyc	7085 7900 8710	8880 9050 9220	9395 9565 9735	9905 10075 10320	10565 10805 11050						
40 km/h	5450 6075 6700	6830 6965 7095	7225 7355 7490	7620 7750 7940	8125 8315 8500						

Ø Pulgadas	Descripción	CAI	S mm	D mm	R' mm	Cdr. mm	Llanta recomendada	Llanta permitida	Cámara de aire (Código)	Volumen interno al 75% (litros)	Profundidad de la banda de rodamiento (mm)
38	VF 900/60 R38 CFO+ 193A8 TL NUEVO	439024	879	2029	889	5993	DW30B (A)			1149	58
Bar	1.2 1.4 1.6	1.7 1.8 1.9	2.0 2.1 2.2	2.3 2.4 2.5	2.6 2.7 2.8						
Psi	17 20 23	25 26 28	29 30 32	33 35 36	38 39 41						
10 km/h Cyc	10455 11605 12750	13070 13390 13705	14025 14345 14665	14980 15300 15725	16150 16575 17000						
15 km/h Cyc	9765 10885 12000	12245 12490 12730	12975 13220 13465	13705 13950 14350	14750 15150 15550						
40 km/h	7300 8025 8750	8980 9215 9445	9675 9905 10140	10370 10600 10825	11050 11275 11500						

* Consultar las notas al final de las tablas de esta gama.

MICHELIN® CEREXBIB 2

Características y presiones en (Bar) y (Psi): carga por neumático en kg*

Ø Pulgadas	Descripción	CAI	S mm	D mm	R' mm	Cdr. mm	Llanta recomendada	Llanta permitida	Cámara de aire (Código)	Volumen interno al 75% (litros)	Profundidad de la banda de rodamiento (mm)
38	IF 800/70 R38 CFO+ 187A8 TL NUEVO	610997	790	2051	912	6079	DW27B (A)		804	1088	57
Bar	1.2 1.4 1.6 1.7 1.8 1.9 2.0 2.1 2.2 2.3 2.4 2.5 2.6 2.7 2.8										
Psi	17 20 23 25 26 28 29 30 32 33 35 36 38 39 41										
10 km/h Cyc	10710 11945 13175 13440 13705 13970 14240 14505 14770 15035 15300 15620 15940 16255 16575										
15 km/h Cyc	9765 10885 12000 12245 12490 12730 12975 13220 13465 13705 13950 14240 14530 14820 15110										
40 km/h	6300 7025 7750 7905 8065 8220 8375 8530 8690 8845 9000 9190 9375 9565 9750										

Ø Pulgadas	Descripción	CAI	S mm	D mm	R' mm	Cdr. mm	Llanta recomendada	Llanta permitida	Cámara de aire (Código)	Volumen interno al 75% (litros)	Profundidad de la banda de rodamiento (mm)
42	VF 520/85 R42 CFO+ 177A8 TL NUEVO	270459	541	1953	881	5807	DW18B(A)	DD18W18L	802	545	55
Bar	1.2 1.4 1.6 1.7 1.8 1.9 2.0 2.1 2.2 2.3 2.4 2.5 2.6 2.7 2.8										
Psi	17 20 23 25 26 28 29 30 32 33 35 36 38 39 41										
10 km/h Cyc Dual	5985 6640 7295 7470 7640 7815 7985 8160 8330 8505 8675 8865 9050 9240 9425										
15 km/h Cyc Dual	5455 6055 6650 6810 6965 7125 7280 7440 7595 7755 7910 8080 8255 8425 8595										
40 km/h	4625 5215 5800 5915 6025 6140 6250 6365 6475 6590 6700 6850 7000 7150 7300										

Ø Pulgadas	Descripción	CAI	S mm	D mm	R' mm	Cdr. mm	Llanta recomendada	Llanta permitida	Cámara de aire (Código)	Volumen interno al 75% (litros)	Profundidad de la banda de rodamiento (mm)
42	VF 580/85 R42 CFO+ 183A8 TL NUEVO	844076	580	2040	903	6040	DW18B(A)		802	701	58
Bar	1.2 1.4 1.6 1.7 1.8 1.9 2.0 2.1 2.2 2.3 2.4 2.5 2.6 2.7 2.8										
Psi	17 20 23 25 26 28 29 30 32 33 35 36 38 39 41										
10 km/h Cyc	8075 8970 9860 10050 10245 10435 10625 10815 11010 11200 11390 11730 12070 12410 12750										
15 km/h Cyc	7365 8180 8990 9165 9340 9515 9690 9860 10035 10210 10385 10695 11005 11315 11625										
10 km/h Cyc Dual	7110 7895 8680 8850 9015 9185 9350 9520 9685 9855 10020 10320 10620 10920 11220										
15 km/h Cyc Dual	6480 7195 7910 8065 8220 8370 8525 8680 8835 8985 9140 9415 9685 9960 10230										
40 km/h	5450 6075 6700 6865 7025 7190 7350 7515 7675 7840 8000 8190 8375 8565 8750										

Ø Pulgadas	Descripción	CAI	S mm	D mm	R' mm	Cdr. mm	Llanta recomendada	Llanta permitida	Cámara de aire (Código)	Volumen interno al 75% (litros)	Profundidad de la banda de rodamiento (mm)
42	VF 710/70 R42 CFO+ 188A8 TL NUEVO	499992	705	2097	927	6207	DW23B (A)	DW25B (A)	802	867	64
Bar	1.2 1.4 1.6 1.7 1.8 1.9 2.0 2.1 2.2 2.3 2.4 2.5 2.6 2.7 2.8										
Psi	17 20 23 25 26 28 29 30 32 33 35 36 38 39 41										
10 km/h Cyc	9265 10330 11390 11615 11835 12060 12280 12505 12730 12950 13175 13495 13815 14130 14450										
15 km/h Cyc	8450 9420 10385 10590 10795 10995 11200 11405 11610 11810 12015 12305 12595 12885 13175										
40 km/h	7750 7905 8065 8220 8375 8530 8690 8845 9000 9250 9500 9750 10000										

* Consultar las notas al final de las tablas de esta gama.

MICHELIN® CEREXBIB 2

Características y presiones en (Bar) y (Psi): carga por neumático en kg*

Ø Pulgadas	Descripción	CAI	S mm	D mm	R' mm	Cdr. mm	Llanta recomendada	Llanta permitida	Cámara de aire (Código)	Volumen interno al 75% (litros)	Profundidad de la banda de rodamiento (mm)
42	IF 800/70 R42 CFO+ 189A8 TL NUEVO	818789	770	2118	964	6387	DW27B (A)	DW25B (A) DW28B (A)		1145	58
Bar	1.2 1.4 1.6 1.7 1.8 1.9 2.0 2.1 2.2 2.3 2.4 2.5 2.6 2.7 2.8										
Psi	17 20 23 25 26 28 29 30 32 33 35 36 38 39 41										
10 km/h Cyc	11050 12325 13600 13920 14240 14555 14875 15195 15515 15830 16150 16490 16830 17170 17510										
15 km/h Cyc	10075 11240 12400 12690 12980 13270 13565 13855 14145 14435 14725 15035 15345 15655 15965										
30 km/h Cyc	8450 9425 10400 10645 10890 11130 11375 11620 11865 12105 12350 12610 12870 13130 13390										
40 km/h	6500 7250 8000 8190 8375 8565 8750 8940 9125 9315 9500 9700 9900 10100 10300										

Ø Pulgadas	Descripción	CAI	S mm	D mm	R' mm	Cdr. mm	Llanta recomendada	Llanta permitida	Cámara de aire (Código)	Volumen interno al 75% (litros)	Profundidad de la banda de rodamiento (mm)
42	VF 900/60 R42 CFO+ 195A8 TL NUEVO	856296	843	2118	930	6281	DW30B (A)	TW30B		1227	59
Bar	1.2 1.4 1.6 1.7 1.8 1.9 2.0 2.1 2.2 2.3 2.4 2.5 2.6 2.7 2.8										
Psi	17 20 23 25 26 28 29 30 32 33 35 36 38 39 41										
10 km/h Cyc	11050 12325 13600 13920 14240 14555 14875 15195 15515 15830 16150 16490 16830 17170 17510										
15 km/h Cyc	10075 11240 12400 12690 12985 13275 13565 13855 14145 14435 14725 15035 15345 15655 15965										
30 km/h Cyc	8450 9425 10400 10645 10890 11130 11375 11620 11865 12105 12350 12610 12870 13130 13390										
40 km/h	7500 8375 9250 9515 9775 10040 10300 10525 10750 10975 11200 11440 11675 11915 12150										

***IMPORTANTE:**

La presión de inflado se determina siempre en función de la carga por neumático, de la velocidad y del trabajo a realizar. Las recomendaciones anteriores se facilitan con la salvedad de modificaciones posteriores a la fecha de difusión de estas tablas (junio de 2018). Los datos técnicos pueden sufrir modificaciones sin previo aviso.

- Para máquinas autonivelantes o que trabajan en pendientes superiores al 20% (11°), aumentar la presión 0.5 Bar sin superar la carga máxima del neumático.
- Para uso intensivo en carretera (>50%), añadir 0.4 Bar.
- 10 km/h Cyc: Trabajos de recolección con cargas cíclicas a 10 km/h.
- 15 km/h Cyc: Trabajos de recolección con cargas cíclicas a 15 km/h.
- 30 km/h Cyc: Trabajos de recolección con cargas cíclicas a 30 km/h.
- CFO +: Cyclic Field Operation (operación de campo cíclica); se genera un extra para cargas cíclicas en el campo (máximo 1.5 km).



**MICHELIN®
CEREXBIB**

**ALTA CAPACIDAD DE CARGA
A BAJA PRESIÓN PARA
COSECHADORAS GRANDES**



Para **COSECHADORAS GRANDES**



MEJOR RENDIMIENTO

- +4% / al año⁽¹⁾



Mayor **CAPACIDAD DE CARGA** hasta en un 40%⁽²⁾



MÁS TRACCIÓN

- Mejor tracción en pendientes
- Capacidad para trabajar en terreno húmedo
- +25%⁽³⁾ mayor área de contacto con el suelo



BAJA PRESIÓN

- -35%⁽¹⁾, hasta 1 Bar menos de presión en comparación con la generación anterior⁽³⁾

(1) Universidad Harper Adams 2014/2016 (2) Pruebas internas realizadas en 2013-2015.

(3) Neumáticos IF 1000/55 R32 CFO MICHELIN® CEREXBIB frente a los 1050/50 R32 MICHELIN® MEGAXBIB.

DIMENSIONES

VF 520/80 R26 CFO 168A8 TL
VF 620/70 R26 CFO 173A8 TL
VF 750/65 R26 CFO 177A8 TL
VF 620/70 R30 CFO 172A8 TL
VF 520/85 R30 CFO 172A8 TL
IF 800/65 R32 CFO 178A8 TL

IF 900/60 R32 CFO 185A8 TL
IF 1000/55 R32 CFO 188A8 TL
IF 680/85 R32 CFO 179A8 TL
IF 800/70 R32 CFO 182A8 TL
IF 680/75 R38 CFO 180A8 TL
IF 900/60 R38 CFO 188A8 TL

IF 900/60 R38 CFO 184A8 TL
IF 800/70 R38 CFO 184A8 TL
IF 800/70 R38 CFO 187A8 TL
VF 520/85 R42 CFO 177A8 TL
IF 710/70 R42 CFO 182A8 TL

MICHELIN® CEREXBIB

Características y presiones en (Bar) y (Psi): carga por neumático en kg*

Ø Pulgadas	Descripción	CAI	S mm	D mm	R' mm	Cdr. mm	Llanta recomendada	Llanta permitida	Cámara de aire (Código)	Volumen interno al 75% (litros)	Profundidad de la banda de rodamiento (mm)				
26	VF 520/80 R26 CFO 168A8 TL	972024	503	1491	649	4397	DW16L	DW18L W16L	716	366	44				
Bar	1.2	1.4	1.6	1.7	1.8	1.9	2.0	2.1	2.2	2.3	2.4	2.5	2.6	2.7	2.8
Psi	17	20	23	25	26	28	29	30	32	33	35	36	38	39	41
15 km/h Cyc	4720	5270	5820	5950	6080	6205	6335	6465	6595	6720	6850	7000	7150	7300	7450
40 km/h	3550	3965	4375	4470	4570	4665	4765	4860	4955	5055	5150	5265	5375	5490	5600

Ø Pulgadas	Descripción	CAI	S mm	D mm	R' mm	Cdr. mm	Llanta recomendada	Llanta permitida	Cámara de aire (Código)	Volumen interno al 75% (litros)	Profundidad de la banda de rodamiento (mm)				
26	VF 620/70 R26 CFO 173A8 TL	656967	606	1513	655	4458	DW20B (A)		716	463	45				
Bar	1.2	1.4	1.6	1.7	1.8	1.9	2.0	2.1	2.2	2.3	2.4	2.5	2.6	2.7	2.8
Psi	17	20	23	25	26	28	29	30	32	33	35	36	38	39	41
15 km/h Cyc	5485	6170	6850	6990	7135	7275	7415	7555	7700	7840	7980	8150	8315	8485	8650
40 km/h	4125	4640	5150	5255	5365	5470	5575	5680	5790	5895	6000	6125	6250	6375	6500

Ø Pulgadas	Descripción	CAI	S mm	D mm	R' mm	Cdr. mm	Llanta recomendada	Llanta permitida	Cámara de aire (Código)	Volumen interno al 75% (litros)	Profundidad de la banda de rodamiento (mm)				
26	VF 750/65 R26 CFO 177A8 TL	811382	743	1623	701	4780	DW25B (A)		833	659	48				
Bar	1.2	1.4	1.6	1.7	1.8	1.9	2.0	2.1	2.2	2.3	2.4	2.5	2.6	2.7	2.8
Psi	17	20	23	25	26	28	29	30	32	33	35	36	38	39	41
15 km/h Cyc	6850	7515	8180	8370	8565	8755	8945	9135	9330	9520	9710				
40 km/h	5150	5650	6150	6295	6440	6580	6725	6870	7015	7155	7300				

Ø Pulgadas	Descripción	CAI	S mm	D mm	R' mm	Cdr. mm	Llanta recomendada	Llanta permitida	Cámara de aire (Código)	Volumen interno al 75% (litros)	Profundidad de la banda de rodamiento (mm)				
30	VF 620/70 R30 CFO 172A8 TL	886789	598	1615	700	4760	DW20B (A)		737	506	43				
Bar	1.2	1.4	1.6	1.7	1.8	1.9	2.0	2.1	2.2	2.3	2.4	2.5	2.6	2.7	2.8
Psi	17	20	23	25	26	28	29	30	32	33	35	36	38	39	41
15 km/h Cyc	5985	6620	7250	7390	7535	7675	7815	7955	8100	8240	8380				
40 km/h	4500	4975	5450	5555	5665	5770	5875	5980	6090	6195	6300				

* Consultar las notas al final de las tablas de esta gama.

MICHELIN® CEREXBIB

Características y presiones en (Bar) y (Psi): carga por neumático en kg*

Ø Pulgadas	Descripción	CAI	S mm	D mm	R' mm	Cdr. mm	Llanta recomendada	Llanta permitida	Cámara de aire (Código)	Volumen interno al 75% (litros)	Profundidad de la banda de rodamiento (mm)
30	VF 520/85 R30 CFO 172A8 TL	795916	522	1624	709	4794	W16L		737	435	46
Bar	1.2 1.4 1.6 1.7 1.8 1.9 2.0 2.1 2.2 2.3 2.4 2.5 2.6 2.7 2.8										
Psi	17 20 23 25 26 28 29 30 32 33 35 36 38 39 41										
15 km/h Cyc	5320 5905 6485 6640 6795 6945 7100 7255 7410 7560 7715 7880 8050 8215 8380										
40 km/h	4000 4440 4875 4990 5105 5220 5340 5455 5570 5685 5800 5925 6050 6175 6300										

Ø Pulgadas	Descripción	CAI	S mm	D mm	R' mm	Cdr. mm	Llanta recomendada	Llanta permitida	Cámara de aire (Código)	Volumen interno al 75% (litros)	Profundidad de la banda de rodamiento (mm)
32	IF 800/65 R32 CFO 178A8 TL	651074	768	1855	818	5493	DW27B (A)	DW30B (A)	831	903	57
Bar	1.2 1.4 1.6 1.7 1.8 1.9 2.0 2.1 2.2 2.3 2.4 2.5 2.6 2.7 2.8										
Psi	17 20 23 25 26 28 29 30 32 33 35 36 38 39 41										
15 km/h Cyc	8215 8990 9765 10000 10230 10465 10695 10930 11160 11395 11625										
40 km/h	5300 5800 6300 6450 6600 6750 6900 7050 7200 7350 7500										

Ø Pulgadas	Descripción	CAI	S mm	D mm	R' mm	Cdr. mm	Llanta recomendada	Llanta permitida	Cámara de aire (Código)	Volumen interno al 75% (litros)	Profundidad de la banda de rodamiento (mm)
32	IF 900/60 R32 CFO 185A8 TL	752825	856	1906	844	5643	DW27B (A)	DW30B (A)	831	1033	58
Bar	1.2 1.4 1.6 1.7 1.8 1.9 2.0 2.1 2.2 2.3 2.4 2.5 2.6 2.7 2.8										
Psi	17 20 23 25 26 28 29 30 32 33 35 36 38 39 41										
15 km/h Cyc	8990 9995 11000 11270 11545 11815 12090 12360 12630 12905 13175 13465 13760 14050 14340										
40 km/h	5800 6450 7100 7275 7450 7625 7800 7975 8150 8325 8500 8690 8875 9065 9250										

Ø Pulgadas	Descripción	CAI	S mm	D mm	R' mm	Cdr. mm	Llanta recomendada	Llanta permitida	Cámara de aire (Código)	Volumen interno al 75% (litros)	Profundidad de la banda de rodamiento (mm)
32	IF 1000/55 R32 CFO 188A8 TL	131720	1040	1931	882	5758	36.00VA		Joint OR2052	1178	59
Bar	1.2 1.4 1.6 1.7 1.8 1.9 2.0 2.1 2.2 2.3 2.4 2.5 2.6 2.7 2.8										
Psi	17 20 23 25 26 28 29 30 32 33 35 36 38 39 41										
15 km/h Cyc	9765 10890 12015 12305 12595 12885 13180 13470 13760 14050 14340 14630 14920 15210 15500										
40 km/h	6300 7025 7750 7940 8125 8315 8500 8690 8875 9065 9250 9440 9625 9815 10000										

* Consultar las notas al final de las tablas de esta gama.

MICHELIN® CEREXBIB

Características y presiones en (Bar) y (Psi): carga por neumático en kg*

Ø Pulgadas	Descripción	CAI	S mm	D mm	R' mm	Cdr. mm	Llanta recomendada	Llanta permitida	Cámara de aire (Código)	Volumen interno al 75% (litros)	Profundidad de la banda de rodamiento (mm)
32	IF 680/85 R32 CFO 179A8 TL	932041	682	1935	844	5711	DW23B (A)	DW21B (A)	831	859	46
Bar	1.2 1.4 1.6 1.7 1.8 1.9 2.0 2.1 2.2 2.3 2.4 2.5 2.6 2.7 2.8										
Psi	17 20 23 25 26 28 29 30 32 33 35 36 38 39 41										
15 km/h Cyc	8450 9420 10385 10590 10795 10995 11200 11405 11610 11810 12015										
40 km/h	5450 6075 6700 6830 6965 7095 7225 7355 7490 7620 7750										

Ø Pulgadas	Descripción	CAI	S mm	D mm	R' mm	Cdr. mm	Llanta recomendada	Llanta permitida	Cámara de aire (Código)	Volumen interno al 75% (litros)	Profundidad de la banda de rodamiento (mm)
32	IF 800/70 R32 CFO 182A8 TL	525718	784	1958	864	5788	DW27B (A)		831	966	55
Bar	1.2 1.4 1.6 1.7 1.8 1.9 2.0 2.1 2.2 2.3 2.4 2.5 2.6 2.7 2.8										
Psi	17 20 23 25 26 28 29 30 32 33 35 36 38 39 41										
15 km/h Cyc	8990 10000 11005 11275 11550 11820 12090 12360 12635 12905 13175										
40 km/h	5800 6450 7100 7275 7450 7625 7800 7975 8150 8325 8500										

Ø Pulgadas	Descripción	CAI	S mm	D mm	R' mm	Cdr. mm	Llanta recomendada	Llanta permitida	Cámara de aire (Código)	Volumen interno al 75% (litros)	Profundidad de la banda de rodamiento (mm)
38	IF 680/75 R38 CFO 180A8 TL	833220	663	1965	874	5823	DW23B (A)	DW21B (A)		803	59
Bar	1.2 1.4 1.6 1.7 1.8 1.9 2.0 2.1 2.2 2.3 2.4 2.5 2.6 2.7 2.8										
Psi	17 20 23 25 26 28 29 30 32 33 35 36 38 39 41										
15 km/h Cyc	7980 8875 9765 10000 10230 10465 10695 10930 11160 11395 11625 11820 12015 12205 12400										
15 km/h Cyc > slope 20%	7980 8425 8875 9320 9765 10000 10230 10465 10695 10930 11160 11395										
40 km/h	5150 5725 6300 6450 6600 6750 6900 7050 7200 7350 7500 7625 7750 7875 8000										

Ø Pulgadas	Descripción	CAI	S mm	D mm	R' mm	Cdr. mm	Llanta recomendada	Llanta permitida	Cámara de aire (Código)	Volumen interno al 75% (litros)	Profundidad de la banda de rodamiento (mm)
38	IF 900/60 R38 CFO 188A8 TL	853436	879	2029	902	6017	DW30B (A)			1149	58
Bar	1.2 1.4 1.6 1.7 1.8 1.9 2.0 2.1 2.2 2.3 2.4 2.5 2.6 2.7 2.8										
Psi	17 20 23 25 26 28 29 30 32 33 35 36 38 39 41										
15 km/h Cyc	9765 10885 12000 12245 12490 12730 12975 13220 13465 13705 13950 14350 14750 15150 15550										
40 km/h	6300 7025 7750 7905 8065 8220 8375 8530 8690 8845 9000 9250 9500 9750 10000										

* Consultar las notas al final de las tablas de esta gama.

MICHELIN® CEREXBIB

Características y presiones en (Bar) y (Psi): carga por neumático en kg*

Ø Pulgadas	Descripción	CAI	S mm	D mm	R' mm	Cdr. mm	Llanta recomendada	Llanta permitida	Cámara de aire (Código)	Volumen interno al 75% (litros)	Profundidad de la banda de rodamiento (mm)				
38	IF 900/60 R38 CFO 184A8 TL	296920	874	2033	904	6017	DW30B (A)			1149	58				
Bar	1.2	1.4	1.6	1.7	1.8	1.9	2.0	2.1	2.2	2.3	2.4	2.5	2.6	2.7	2.8
Psi	17	20	23	25	26	28	29	30	32	33	35	36	38	39	41
15 km/h Cyc	9765	10885	12000	12245	12490	12730	12975	13220	13465	13705	13950				
40 km/h	6300	7025	7750	7905	8065	8220	8375	8530	8690	8845	9000				

Ø Pulgadas	Descripción	CAI	S mm	D mm	R' mm	Cdr. mm	Llanta recomendada	Llanta permitida	Cámara de aire (Código)	Volumen interno al 75% (litros)	Profundidad de la banda de rodamiento (mm)				
38	IF 800/70 R38 CFO 184A8 TL	646846	781	2048	908	6072	DW27B (A)		804	1088	57				
Bar	1.2	1.4	1.6	1.7	1.8	1.9	2.0	2.1	2.2	2.3	2.4	2.5	2.6	2.7	2.8
Psi	17	20	23	25	26	28	29	30	32	33	35	36	38	39	41
15 km/h Cyc	9765	10885	12000	12245	12490	12730	12975	13220	13465	13705	13950				
40 km/h	6300	7025	7750	7905	8065	8220	8375	8530	8690	8845	9000				

Ø Pulgadas	Descripción	CAI	S mm	D mm	R' mm	Cdr. mm	Llanta recomendada	Llanta permitida	Cámara de aire (Código)	Volumen interno al 75% (litros)	Profundidad de la banda de rodamiento (mm)				
38	IF 800/70 R38 CFO 187A8 TL	445898	790	2051	912	6079	DW27B (A)		804	1088	57				
Bar	1.2	1.4	1.6	1.7	1.8	1.9	2.0	2.1	2.2	2.3	2.4	2.5	2.6	2.7	2.8
Psi	17	20	23	25	26	28	29	30	32	33	35	36	38	39	41
15 km/h Cyc	9765	10885	12000	12245	12490	12730	12975	13220	13465	13705	13950	14240	14530	14820	15110
40 km/h	6300	7025	7750	7905	8065	8220	8375	8530	8690	8845	9000	9190	9375	9565	9750

Ø Pulgadas	Descripción	CAI	S mm	D mm	R' mm	Cdr. mm	Llanta recomendada	Llanta permitida	Cámara de aire (Código)	Volumen interno al 75% (litros)	Profundidad de la banda de rodamiento (mm)				
42	VF 520/85 R42 CFO 177A8 TL	934265	541	1953	881	5807	DW18B(A)	DD18 DW18L	802	545	55				
Bar	1.2	1.4	1.6	1.7	1.8	1.9	2.0	2.1	2.2	2.3	2.4	2.5	2.6	2.7	2.8
Psi	17	20	23	25	26	28	29	30	32	33	35	36	38	39	41
15 km/h Cyc Dual	5455	5865	6275	6480	6685	6885	7090	7295	7500	7705	7910	8080	8255	8425	8595
40 km/h	4625	4970	5315	5490	5665	5835	6010	6180	6355	6525	6700	6850	7000	7150	7300

* Consultar las notas al final de las tablas de esta gama.

Características y presiones en (Bar) y (Psi): carga por neumático en kg*

Ø Pulgadas	Descripción	CAI	S mm	D mm	R' mm	Cdr. mm	Llanta recomendada	Llanta permitida	Cámara de aire (Código)	Volumen interno al 75% (litros)	Profundidad de la banda de rodamiento (mm)				
42	IF 710/70 R42 CFO 182A8 TL	003912	705	2097	942	6230	DW23B (A)		802	872	64				
Bar	1.2	1.4	1.6	1.7	1.8	1.9	2.0	2.1	2.2	2.3	2.4	2.5	2.6	2.7	2.8
Psi	17	20	23	25	26	28	29	30	32	33	35	36	38	39	41
15 km/h Cyc		9300	10385	10590	10790	10995	11200	11400	11605	11805	12010	12300	12595	12885	13175
40 km/h		6000	6700	6830	6965	7095	7225	7355	7490	7620	7750	7940	8125	8315	8500

***IMPORTANTE:**

La presión de inflado se determina siempre en función de la carga por neumático, de la velocidad y del trabajo a realizar. Las recomendaciones anteriores se facilitan con la salvedad de modificaciones posteriores a la fecha de difusión de estas tablas (junio de 2018). Los datos técnicos pueden sufrir modificaciones sin previo aviso.

Los neumáticos CEREXBIB con los marcajes VF y CFO se desarrollaron de conformidad con la norma experimental ETRTO, implementada en 2014 durante un periodo de 4 meses, antes de la posible adopción de una nueva norma.

Los neumáticos que cumplen con esta nueva norma experimental deben llevar las letras VF, como prefijo de la dimensión, y las letras CFO, como sufijo; además, estos neumáticos soportan el aumento de carga indicado en la tabla anterior. Los neumáticos que no llevan este marcaje específico no soportan un incremento de la carga en condiciones de carga cíclica.

- Para máquinas autonivelantes o que trabajan en pendientes superiores al 20% (11°), aumentar la presión 0.5 Bar sin superar la carga máxima del neumático.
- Para uso intensivo en carretera (> 50%), añadir 0.4 Bar.
- 15 Km/h Cyc: trabajos de recolección con cargas cíclicas a 15 km/h.
- CFO +: Cyclic Field Operation (operación de campo cíclica); se genera un extra para cargas cíclicas en el campo (máximo 1.5 km).



NUEVO

MICHELIN® FLOATXBIB

**MAYOR CAPACIDAD DE
CARGA, EN EL CAMPO
Y MAYOR ÍNDICE DE
VELOCIDAD EN LAS
CARRETERAS**



PARA **APLICADORES DE FERTILIZANTES SÓLIDOS**



PRODUCTIVIDAD INCREMENTADA

- Mejor distribución de la presión
- Mejor resistencia al desgaste y al rastrojo
- NUEVO diseño innovador de la banda de rodadura y NUEVO compuesto de goma que proporcionan beneficios ULTRAFLEX: baja presión, alta carga y velocidad
- 1^{er} índice CFO E, para uso flotante (el CFO permite una capacidad de carga aumentada en un 55% cuando se opera por debajo de 15 km/h)



MEJORES RENDIMIENTOS

- Los hombros redondeados permiten proteger la capa de vegetación
- Los hombros dobles reforzados mejoran el área de contacto



MAYOR CONFORT

- Zona central reforzada con diseño especial

DIMENSIONES

VF 1000/50R25 CFO 190D/186E TL **NUEVO**

VF 750/50R26 CFO 174D/170E TL **NUEVO**

IF 1000/55R32 CFO 191D/188E TL

VF 1000/55R32 CFO 197D/193E TL **NUEVO**

VF 900/60R38 CFO 196D/192E TL **NUEVO**

MICHELIN® FLOATXBIB

Características y presiones en (Bar) y (Psi): carga por neumático en kg*

Ø Pulgadas	Descripción	CAI	S mm	D mm	R' mm	Cdr. mm	Llanta recomendada	Llanta permitida	Cámara de aire (Código)	Volumen interno al 75% (litros)	Profundidad de la banda de rodamiento (mm)
25	VF 1000/50R25 CFO 190D/186E TL NUEVO	713716	1040	1636	717	4845	36.0TH			893	40
Bar	1.2 1.4 1.6 1.8 2 2.2 2.4 2.6 2.8 3 3.2										
Psi	17 20 23 26 29 32 35 38 41 44 46										
15 km/h Cyc	8215 9145 10075 10540 11005 11510 12013 12595 13175 13565 13950										
30 km/h Cyc	6890 7670 8450 8840 9230 9655 10075 10565 11050 11375 11700										
65 km/h	6150 6825 7500 7875 8250 8625 9000 9375 9750 10175 10600										
70 km/h	5597 6210 6825 7165 7508 7850 8190 8530 8873 9185 9500										

Ø Pulgadas	Descripción	CAI	S mm	D mm	R' mm	Cdr. mm	Llanta recomendada	Llanta permitida	Cámara de aire (Código)	Volumen interno al 75% (litros)	Profundidad de la banda de rodamiento (mm)
26	VF 750/50R26 CFO 174D/170E TL NUEVO	982905	749.5	1405	619	4155	DW25B (A)			458	39
Bar	1.2 1.4 1.6 1.8 2 2.2 2.4 2.6 2.8 3 3.2										
Psi	17 20 23 26 29 32 35 38 41 44 46										
15 km/h Cyc	5193 5795 6394 6685 6975 7265 7556 8000 8448 8720 8990										
30 km/h Cyc	4355 4860 5363 5605 5850 6095 6338 6710 7085 7315 7540										
65 km/h	3875 4315 4750 5025 5300 5550 5800 6050 6300 6500 6700										
70 km/h	3526 3925 4323 4575 4823 5050 5278 5505 5733 5865 6000										

Ø Pulgadas	Descripción	CAI	S mm	D mm	R' mm	Cdr. mm	Llanta recomendada	Llanta permitida	Cámara de aire (Código)	Volumen interno al 75% (litros)	Profundidad de la banda de rodamiento (mm)
32	IF 1000/55 R32 CFO 191D/188E TL	564739	1042	1877	820	5540	36.00VA			1178	38
Bar	1.2 1.4 1.6 1.8 2 2.2 2.4 2.6 2.8 3 3.2										
Psi	17 20 23 26 29 32 35 38 41 44 46										
15 km/h Cyc	9765 10890 12013 12595 13175 13755 14338 14920 15500 16200 16895										
30 km/h Cyc	8190 9135 10075 10565 11050 11540 12025 12515 13000 13585 14170										
65 km/h	6300 7025 7750 8125 8500 8875 9250 9625 10000 10450 10900										
70 km/h	5800 6450 7100 7425 7750 8125 8500 8875 9250 9625 10000										

* Consultar las notas al final de las tablas de esta gama.

MICHELIN® FLOATXBIB

Características y presiones en (Bar) y (Psi): carga por neumático en kg*

Ø Pulgadas	Descripción	CAI	S mm	D mm	R' mm	Cdr. mm	Llanta recomendada	Llanta permitida	Cámara de aire (Código)	Volumen interno al 75% (litros)	Profundidad de la banda de rodamiento (mm)
32	VF 1000/55R32 CFO 197D/193E TL NUEVO	946690	1042	1877	805	5520	36.00VA			1178	
Bar	1.2	1.4	1.6	1.8	2	2.2	2.4	2.6	2.8	3	3.2
Psi	17	20	23	26	29	32	35	38	41	44	46
15 km/h Cyc	9765	10890	12015	12595	13175	13760	14340	14920	15500	16200	16895
30 km/h Cyc	8190	9135	10075	10565	11050	11540	12025	12515	13000	13585	14170
65 km/h	7300	7775	8250	9125	10000	10450	10900	11350	11800	12325	12850
70 km/h	6650	7075	7500	8300	9100	9500	9900	10325	10750	11225	11700

Ø Pulgadas	Descripción	CAI	S mm	D mm	R' mm	Cdr. mm	Llanta recomendada	Llanta permitida	Cámara de aire (Código)	Volumen interno al 75% (litros)	Profundidad de la banda de rodamiento (mm)
38	VF 900/60R38 CFO 196D/192E TL NUEVO	098689	872	2033	914	6041	DW30B (A)	DW27B (A)		1149	39
Bar	1.2	1.4	1.6	1.8	2	2.2	2.4	2.6	2.8	3	3.2
Psi	17	20	23	26	29	32	35	38	41	44	46
15 km/h Cyc	9533	10580	11625	12400	13175	13565	13950	14725	15500	15965	16430
30 km/h Cyc	7995	8875	9750	10400	11050	11375	11700	12350	13000	13390	13780
65 km/h	7300	8025	8750	9250	9750	10175	10600	11050	11500	12000	12500
70 km/h	6643	7305	7963	8420	8873	9260	9646	10055	10465	10835	11200

***IMPORTANTE:**

La presión de inflado se determina siempre en función de la carga por neumático, de la velocidad y del trabajo a realizar. Las recomendaciones anteriores se facilitan con la salvedad de modificaciones posteriores a la fecha de difusión de estas tablas (junio de 2018). Los datos técnicos pueden sufrir modificaciones sin previo aviso.

- Para máquinas autonivelantes o que trabajan en pendientes superiores al 20% (11°), aumentar la presión 0.5 Bar sin superar la carga máxima del neumático.
- Para uso intensivo en carretera (>50%), añadir 0.4 Bar.
- 15 km/h Cyc: trabajos de recolección con cargas cíclicas a 15 km/h.
- CFO +: Cyclic Field Operation (operación de campo cíclica); se genera un extra para cargas cíclicas en el campo (máximo 1.5 km).



MICHELIN® MEGAXBIB 2

**UN VALOR EXCELENTE
PARA COSECHADORAS Y
MAQUINARIA PESADA**



PARA **COSECHADORAS**



ROBUSTEZ Y MAYOR RESISTENCIA AL RASTROJO

- Casco reforzado
- Mayor vida útil



BENEFICIOS DE LA GAMA MEGAXBIB

- Excelente comportamiento en carretera
- Capacidad para soportar grandes cargas y velocidades altas



NUEVO MARCAJE

- Stubble Shield (escudo antirastrojo)



DIMENSIONES

1000/50 R25 172A8/166D TL
750/50 R26 160A8/154D TL
650/75R32 172A8/172B TL
800/65 R32 178A8/178B TL
1050/50 R32 178A8/172D TL
900/60 R32 181A8/181B TL

800/70R32 181A8/181B TL **NUEVO**
710/75R34 178A8/178B TL **NUEVO**
620/70R38 170A8/170B TL **NUEVO**

MICHELIN® MEGAXBIB 2

Características y presiones en (Bar) y (Psi): carga por neumático en kg*

Ø Pulgadas	Descripción	CAI	S mm	D mm	R' mm	Cdr. mm	Llanta recomendada	Llanta permitida	Cámara de aire (Código)	Volumen interno al 75% (litros)	Profundidad de la banda de rodamiento (mm)
25	1000/50 R25 172A8/166D TL	852423	1033	1654	732	4907	36.0TH		Joint R1438	892	46
Bar	1.0 1.3 1.6 1.9 2.2 2.3 2.4 2.5 2.6 2.7 2.8 2.9 3.2										
Psi	15 19 23 28 32 33 35 36 38 39 41 42 46										
10 km/h Cyc		8290	9005	9725	9960	10200	10330	10455	10585	10710	
30 km/h Cyc		6565	7480	8390	8695	9000	9115	9225	9340	9450	
10 km/h	5815 6940	7740	8385	9025	9235	9450					
30 km/h	4145 4950	5670	6070	6475	6605	6740					
40 km/h	3875 4625	5300	5675	6050	6175	6300					
65 km/h	3255 3885	4450	4765	5080	5185	5290					

Ø Pulgadas	Descripción	CAI	S mm	D mm	R' mm	Cdr. mm	Llanta recomendada	Llanta permitida	Cámara de aire (Código)	Volumen interno al 75% (litros)	Profundidad de la banda de rodamiento (mm)	
26	750/50 R26 160A8/154D TL	236906	742	1406	629	4171	DW25B (A)			466	39	
Bar	1.0 1.3 1.6 1.9 2.2 2.3 2.4 2.5 2.6 2.7 2.8 2.9 3.2											
Psi	15 19 23 28 32 33 35 36 38 39 41 42 46											
10 km/h Cyc		5230	5660	6090	6230	6375	6535	6695	6855	7015	7170	7650
30 km/h Cyc		4200	4735	5270	5445	5625	5765	5910	6050	6190	6330	6750
10 km/h**	3750 4400	5175	5555	5935	6065	6190	6330	6470	6610	6750		
30 km/h	2675 3135	3690	3960	4235	4325	4415	4515	4615	4715	4815		
40 km/h	2500 2930	3450	3705	3955	4040	4125	4220	4310	4405	4500		
65 km/h	2100 2465	2900	3110	3325	3395	3465	3545	3620	3700	3780		

Ø Pulgadas	Descripción	CAI	S mm	D mm	R' mm	Cdr. mm	Llanta recomendada	Llanta permitida	Cámara de aire (Código)	Volumen interno al 75% (litros)	Profundidad de la banda de rodamiento (mm)			
32	650/75R32 172A8/172B TL NUEVO	642277	637.7	1817	817	5400	DW21B (A)	DW20B (A) DW23B (A)		647	56			
Bar	1 1.3 1.6 1.9 2.2 2.3 2.4 2.5 2.6 2.7 2.8 2.9 3.2 3.5 3.8													
Psi	15 19 23 28 32 33 35 36 38 39 41 42 46 51 55													
10 km/h**	4500 5220	5940	6420	6895	7055	7215	7375	7535	7695	7855	8015	8495	8970	9450
10 km/h Cyc	4900 5710	6520	7090	7665	7855	8045	8235	8425	8615	8805	8995	9565	10140	10710
25 km/h	3630 4235	4840	5245	5645	5780	5915	6050	6185	6320	6455	6590	6990		
30 km/h	3500 4085	4670	5060	5445	5575	5705	5835	5965	6095	6225	6355	6740		
40 km/h	3280 3820	4360	4725	5090	5210	5330	5450	5575	5695	5815	5935	6300		
50 km/h	3280 3820	4360	4725	5090	5210	5330	5450	5575	5695	5815	5935	6300		

* Consultar las notas al final de las tablas de esta gama.

MICHELIN® MEGAXBIB 2

Características y presiones en (Bar) y (Psi): carga por neumático en kg*

Ø Pulgadas	Descripción	CAI	S mm	D mm	R' mm	Cdr. mm	Llanta recomendada	Llanta permitida	Cámara de aire (Código)	Volumen interno al 75% (litros)	Profundidad de la banda de rodamiento (mm)
32	800/65 R32 178A8/178B TL	135425	786	1839	832	5471	DW27B (A)	DH27(B) DW25B(A)	831	871	56
Bar	1.0 1.3 1.6 1.9 2.2 2.3 2.4 2.5 2.6 2.7 2.8 2.9 3.2 3.5 3.8										
Psi	15 19 23 28 32 33 35 36 38 39 41 42 46 51 55										
10 km/h Cyc	5865 7080 8290 8880 9470 9665 9860 10075 10285 10500 10710 10915 11525 12140 12750										
10 km/h**	5175 6060 6940 7600 8260 8480 8700 8890 9075 9265 9450 9630 10170 10710 11250										
25 km/h	4440 5165 5885 6300 6720 6855 6995 7160 7330 7495 7660 7825 8325										
30 km/h	4280 4975 5670 6070 6475 6605 6740 6900 7065 7225 7385 7545 8025										
40 km/h	4000 4650 5300 5675 6050 6175 6300 6450 6600 6750 6900 7050 7500										
50 km/h	4000 4650 5300 5675 6050 6175 6300 6450 6600 6750 6900 7050 7500										

Ø Pulgadas	Descripción	CAI	S mm	D mm	R' mm	Cdr. mm	Llanta recomendada	Llanta permitida	Cámara de aire (Código)	Volumen interno al 75% (litros)	Profundidad de la banda de rodamiento (mm)
32	1050/50 R32 178A8/172D TL	424273	1037	1866	828	5537	36.00VA		Joint OR2052	1233	42
Bar	1.0 1.3 1.6 1.9 2.2 2.3 2.4 2.5 2.6 2.7 2.8 2.9 3.2										
Psi	15 19 23 28 32 33 35 36 38 39 41 42 46										
10 km/h Cyc	9860 10690 11520 11795 12070 12240 12410 12580 12750										
30 km/h Cyc	7725 8820 9920 10285 10650 10800 10950 11100 11250										
10 km/h**	6940 8260 9450 10125 10800 11025 11250										
30 km/h	4950 5890 6740 7220 7705 7865 8025										
40 km/h	4625 5505 6300 6750 7200 7350 7500										
65 km/h	3885 4625 5290 5670 6050 6175 6300										

Ø Pulgadas	Descripción	CAI	S mm	D mm	R' mm	Cdr. mm	Llanta recomendada	Llanta permitida	Cámara de aire (Código)	Volumen interno al 75% (litros)	Profundidad de la banda de rodamiento (mm)
32	900/60 R32 181A8/181B TL	166896	862	1899	848	5635	DW27B (A)	DW30B(A)	831	1033	57
Bar	1.0 1.3 1.6 1.9 2.2 2.3 2.4 2.5 2.6 2.7 2.8 2.9 3.2 3.5 3.8										
Psi	15 19 23 28 32 33 35 36 38 39 41 42 46 51 55										
10 km/h Cyc	6375 7695 9010 9775 10540 10795 11050 11305 11560 11815 12070 12265 12850 13440 14025										
10 km/h**	5625 6675 7725 8485 9245 9495 9750 9975 10200 10425 10650 10825 11340 11860 12375										
25 km/h	4720 5580 6440 6980 7520 7700 7880 8060 8245 8425 8605 8745 9160										
30 km/h	4550 5380 6205 6725 7250 7420 7595 7770 7945 8120 8295 8430 8830										
40 km/h	4250 5025 5800 6290 6775 6940 7100 7265 7425 7590 7750 7875 8250										
50 km/h	4250 5025 5800 6290 6775 6940 7100 7265 7425 7590 7750 7875 8250										

* Consultar las notas al final de las tablas de esta gama.

MICHELIN® MEGAXBIB 2

Características y presiones en (Bar) y (Psi): carga por neumático en kg*

Ø Pulgadas	Descripción	CAI	S mm	D mm	R' mm	Cdr. mm	Llanta recomendada	Llanta permitida	Cámara de aire (Código)	Volumen interno al 75% (litros)	Profundidad de la banda de rodamiento (mm)
32	800/70R32 181A8/181B TL NUEVO	366785	803	1927		5737	DW27B (A)	DW25B (A)	831	966	56.5
Bar	1 1.3 1.6 1.9 2.2 2.3 2.4 2.5 2.6 2.7 2.8 2.9 3.2 3.5 3.8										
Psi	15 19 23 28 32 33 35 36 38 39 41 42 46 51 55										
10 km/h**	5625 6675 7725 8830 9475 9615 9750 9900 10050 10200 10350 10555 11160 11770 12375										
10 km/h Cyc	6375 7820 9265 9965 10625 10840 11050 11220 11390 11560 11730 11960 12650 13335 14025										
20 km/h	5335 6360 7380 7795 8210 8345 8485 8695 8900 9110 9320 9525 10150										
25 km/h	4815 5740 6660 7035 7410 7535 7660 7850 8035 8225 8410 8600 9160										
30 km/h	4680 5550 6420 6780 7140 7260 7380 7560 7745 7925 8105 8285 8830										
40 km/h	4375 5190 6000 6340 6675 6790 6900 7070 7240 7405 7575 7745 8250										
50 km/h	4375 5190 6000 6340 6675 6790 6900 7070 7240 7405 7575 7745 8250										

Ø Pulgadas	Descripción	CAI	S mm	D mm	R' mm	Cdr. mm	Llanta recomendada	Llanta permitida	Cámara de aire (Código)	Volumen interno al 75% (litros)	Profundidad de la banda de rodamiento (mm)
34	710/75R34 178A8/178B TL NUEVO	312036	697	1909	857	5671	DW23B (A)	DW21B (A) MW23B (A)	765	863	56
Bar	1 1.3 1.6 1.9 2.2 2.3 2.4 2.5 2.6 2.7 2.8 2.9 3.2 3.5 3.8										
Psi	15 19 23 28 32 33 35 36 38 39 41 42 46 51 55										
10 km/h**	5700 6295 6890 7485 8080 8275 8475 8675 8870 9070 9270 9465 10060 10655 11250										
10 km/h Cyc	6260 6955 7650 8345 9040 9275 9505 9735 9970 10200 10430 10665 11360 12055 12750										
25 km/h	4650 5150 5655 6155 6655 6825 6990 7160 7325 7495 7660 7830 8330										
30 km/h	4480 4965 5450 5930 6415 6580 6740 6900 7060 7225 7385 7545 8030										
40 km/h	4190 4640 5095 5545 5995 6145 6295 6445 6595 6750 6900 7050 7500										
50 km/h	4190 4640 5095 5545 5995 6145 6295 6445 6595 6750 6900 7050 7500										

* Consultar las notas al final de las tablas de esta gama.

MICHELIN® MEGAXBIB 2

Características y presiones en (Bar) y (Psi): carga por neumático en kg*

Ø Pulgadas	Descripción	CAI	S mm	D mm	R' mm	Cdr. mm	Llanta recomendada	Llanta permitida	Cámara de aire (Código)	Volumen interno al 75% (litros)	Profundidad de la banda de rodamiento (mm)				
38	620/70R38 170A8/170B TL NUEVO	126128	614	1857		5548	DW20B (A)	DW18L	825	592	56.5				
Bar	1 1.3 1.6 1.9 2.2 2.3 2.4 2.5 2.6 2.7 2.8 2.9 3.2 3.5 3.8														
Psi	15 19 23 28 32 33 35 36 38 39 41 42 46 51 55														
10 km/h**	4560	5035	5510	5985	6465	6620	6780	6940	7095	7255	7415	7575	8050	8525	9000
10 km/h Cyc	5010	5565	6120	6680	7235	7420	7605	7790	7975	8160	8345	8530	9090	9645	10200
25 km/h	3710	4110	4515	4915	5320	5455	5585	5720	5855	5990	6125	6260	6660		
30 km/h	3580	3965	4355	4740	5130	5260	5385	5515	5645	5775	5905	6035	6420		
40 km/h	3350	3710	4075	4435	4795	4915	5035	5155	5275	5400	5520	5640	6000		
50 km/h	3350	3710	4075	4435	4795	4915	5035	5155	5275	5400	5520	5640	6000		

***IMPORTANTE:**

La presión de inflado se determina siempre en función de la carga por neumático, de la velocidad y del trabajo a realizar. Las recomendaciones anteriores se facilitan con la salvedad de modificaciones posteriores a la fecha de difusión de estas tablas (junio de 2018). Los datos técnicos pueden sufrir modificaciones sin previo aviso.

- Para máquinas autonivelantes o que trabajan en pendientes superiores al 20% (11°), utilizar la curva no cíclica a 10 km/h.
 - Para COSECHADORAS, use una tabla no cíclica de 10 km/h y los 30 km/h use la tabla no cíclica para flotadores.
 - Para uso en carreteras pesadas que exceden el 50%, agregue 0.4 Bar.
 - Carga cíclica de 10 km/h o 30 km/h, use solo en el campo, viajando con carga completa que no exceda los 1.5 km.
- **10 km/h LT (torque bajo) (velocidad máxima 10 km/h).



MICHELIN® MEGAXBIB

UN VALOR EXCELENTE
PARA COSECHADORAS Y
MAQUINARIA PESADA



PARA COSECHADORAS



CAPACIDAD DE CARGA

- Hasta 30,600 kg⁽¹⁾ por eje



RESISTENCIA

- Hasta +46%⁽²⁾ frente al competidor principal



COMODIDAD



(1) 1050/50 R32 184A8/184B - ci 6 mph (2) Estudio de pruebas internas (Ladoux, Francia) sobre los neumáticos 800/65R32 178A8/178B.

DIMENSIONES

750/65 R26 166A8/166B TL
750/65 R26 171A8/171B TL
620/75 R26 166A8/166B TL
620/75 R30 168A8/168B TL
650/75 R32 172A8/172B TL
800/65 R32 178A8/178B TL

1050/50 R32 184A8/184B TL T2
900/60 R32 181A8/181B TL
1050/50 R32 178A8 TL M28
800/70 R32 181A8/181B TL
620/75 R34 170A8/170B TL
710/75 R34 178A8/178B TL

620/70 R38 170A8/170B TL
650/85 R38 173A8/173B TL
520/85 R42 162A8/162B TL
620/70 R42 166A8/166B TL

MICHELIN® MEGAXBIB

Características y presiones en (Bar) y (Psi): carga por neumático en kg*

Ø Pulgadas	Descripción	CAI	S mm	D mm	R' mm	Cdr. mm	Llanta recomendada	Llanta permitida	Cámara de aire (Código)	Volumen interno al 75% (litros)	Profundidad de la banda de rodamiento (mm)		
26	750/65 R26 166A8/166B TL	356328	727	1621	725	4811	DW25B (A)		833	677	48		
Bar	0.4 0.6 0.8	1.0	1.2	1.4	1.6	1.7	1.8	1.9	2.1	2.4	2.5	2.6	2.7
Psi	6 9 12	15	17	20	23	25	26	28	30	35	36	38	39
10km/h Cyc		5010	5480	5950	6420	6655	6890	7125	7595	8305	8540	8775	9010
10 km/h**		4600	5000	5400	5800	5995	6190	6385	6775	7365	7560	7755	7950
25 km/h		3860	4145	4435	4720	4865	5010	5155	5445	5880			
30 km/h		3720	3995	4275	4550	4690	4830	4970	5250	5670			
40 km/h		3480	3735	3995	4250	4380	4515	4645	4905	5300			
50 km/h		3480	3735	3995	4250	4380	4515	4645	4905	5300			

Ø Pulgadas	Descripción	CAI	S mm	D mm	R' mm	Cdr. mm	Llanta recomendada	Llanta permitida	Cámara de aire (Código)	Volumen interno al 75% (litros)	Profundidad de la banda de rodamiento (mm)				
26	620/75 R26 166A8/166B TL	614320	588	1602	712	4748	DW20B (A)	DW18L	830	516	46				
Bar	1.0 1.3 1.6	1.9	2.2	2.3	2.4	2.5	2.6	2.7	2.8	2.9	3.2	3.5	3.8		
Psi	15 19 23	28	32	33	35	36	38	39	41	42	46	51	55		
10 km/h Cyc	4410	4820	5230	5745	6260	6435	6605	6775	6950	7120	7290	7465	7980	8495	9010
10 km/h**	3910	4405	4900	5315	5730	5870	6010	6150	6285	6425	6565	6700	7120	7535	7950
25 km/h	3170	3610	4050	4395	4735	4850	4965	5080	5195	5310	5425	5535	5880		
30 km/h	3060	3480	3900	4230	4565	4675	4785	4895	5005	5115	5230	5340	5670		
40 km/h	2860	3250	3640	3950	4265	4365	4470	4575	4680	4780	4885	4990	5300		
50 km/h	2860	3250	3640	3950	4265	4365	4470	4575	4680	4780	4885	4990	5300		

Ø Pulgadas	Descripción	CAI	S mm	D mm	R' mm	Cdr. mm	Llanta recomendada	Llanta permitida	Cámara de aire (Código)	Volumen interno al 75% (litros)	Profundidad de la banda de rodamiento (mm)				
26	750/65 R26 171A8/171B TL	983217	732	1621	730	4818	DW25B (A)		833	677	46				
Bar	1.0 1.3 1.6	1.9	2.2	2.3	2.4	2.5	2.6	2.7	2.8	2.9	3.2	3.5	3.8		
Psi	15 19 23	28	32	33	35	36	38	39	41	42	46	51	55		
10 km/h Cyc	4930	5865	6675	7360	7920	8100	8285	8470	8650	8815	8975	9140	9590	10020	10455
10 km/h**	4350	5080	5760	6380	6940	7110	7285	7460	7630	7775	7920	8060	8460	8845	9225
25 km/h	3610	4175	4735	5240	5630	5765	5895	6030	6160	6270	6380	6495	6825		
30 km/h	3480	4025	4570	5055	5420	5550	5680	5810	5940	6045	6155	6260	6580		
40 km/h	3250	3760	4265	4720	5070	5190	5310	5430	5550	5650	5750	5850	6150		
50 km/h	3250	3760	4265	4720	5070	5190	5310	5430	5550	5650	5750	5850	6150		

* Consultar las notas al final de las tablas de esta gama.

MICHELIN® MEGAXBIB

Características y presiones en (Bar) y (Psi): carga por neumático en kg*

Ø Pulgadas	Descripción	CAI	S mm	D mm	R' mm	Cdr. mm	Llanta recomendada	Llanta permitida	Cámara de aire (Código)	Volumen interno al 75% (litros)	Profundidad de la banda de rodamiento (mm)
30	620/75 R30 168A8/168B TL	753673	604	1710	770	5083	DW20B (A)	DW18L	737	559	46
Bar	1.0 1.3 1.6 1.9 2.2 2.3 2.4 2.5 2.6 2.7 2.8 2.9 3.2 3.5 3.8										
Psi	15 19 23 28 32 33 35 36 38 39 41 42 46 51 55										
10 km/h Cyc	4660 5090 5520 6065 6610 6795 6975 7155 7340 7520 7700 7885 8430 8975 9520										
10 km/h**	4130 4650 5170 5610 6050 6200 6345 6490 6640 6785 6930 7080 7520 7960 8400										
25 km/h	3360 3815 4270 4635 5000 5120 5240 5360 5485 5605 5725 5845 6210										
30 km/h	3240 3680 4120 4470 4820 4940 5055 5170 5290 5405 5525 5640 5990										
40 km/h	3030 3440 3850 4180 4505 4615 4725 4835 4945 5055 5165 5270 5600										
50 km/h	3030 3440 3850 4180 4505 4615 4725 4835 4945 5055 5165 5270 5600										

Ø Pulgadas	Descripción	CAI	S mm	D mm	R' mm	Cdr. mm	Llanta recomendada	Llanta permitida	Cámara de aire (Código)	Volumen interno al 75% (litros)	Profundidad de la banda de rodamiento (mm)
32	650/75 R32 172A8/172B TL	468227	657	1825	821	5423	DW21B (A)	DW20B (A) DW23B (A)	831	698	59
Bar	1.0 1.3 1.6 1.9 2.2 2.3 2.4 2.5 2.6 2.7 2.8 2.9 3.2 3.5 3.8										
Psi	15 19 23 28 32 33 35 36 38 39 41 42 46 51 55										
10 km/h Cyc	4900 5710 6520 7090 7665 7855 8045 8235 8425 8615 8805 8995 9565 10140 10710										
10 km/h**	4500 5220 5940 6420 6895 7055 7215 7375 7535 7695 7855 8015 8495 8970 9450										
25 km/h	3630 4235 4840 5245 5645 5780 5915 6050 6185 6320 6455 6585 6990										
30 km/h	3500 4085 4670 5060 5445 5575 5705 5835 5965 6095 6225 6350 6740										
40 km/h	3280 3820 4360 4725 5090 5210 5330 5450 5575 5695 5815 5935 6300										
50 km/h	3280 3820 4360 4725 5090 5210 5330 5450 5575 5695 5815 5935 6300										

Ø Pulgadas	Descripción	CAI	S mm	D mm	R' mm	Cdr. mm	Llanta recomendada	Llanta permitida	Cámara de aire (Código)	Volumen interno al 75% (litros)	Profundidad de la banda de rodamiento (mm)
32	800/65 R32 178A8/178B TL	521809	793	1840	822	5459	DW27B (A)	DHB27 DW25B (A)	831	903	56
Bar	1.0 1.3 1.6 1.9 2.2 2.3 2.4 2.5 2.6 2.7 2.8 2.9 3.2 3.5 3.8										
Psi	15 19 23 28 32 33 35 36 38 39 41 42 46 51 55										
10 km/h Cyc	5865 7080 8290 8880 9470 9665 9860 10075 10285 10500 10710 10915 11525 12140 12750										
10 km/h**	5175 6060 6940 7600 8260 8480 8700 8890 9075 9265 9450 9630 10170 10710 11250										
25 km/h	4440 5165 5885 6300 6720 6855 6995 7160 7330 7495 7660 7825 8325										
30 km/h	4280 4975 5670 6070 6475 6605 6740 6900 7065 7225 7385 7545 8025										
40 km/h	4000 4650 5300 5675 6050 6175 6300 6450 6600 6750 6900 7050 7500										
50 km/h	4000 4650 5300 5675 6050 6175 6300 6450 6600 6750 6900 7050 7500										

* Consultar las notas al final de las tablas de esta gama.

MICHELIN® MEGAXBIB

Características y presiones en (Bar) y (Psi): carga por neumático en kg*

Ø Pulgadas	Descripción	CAI	S mm	D mm	R' mm	Cdr. mm	Llanta recomendada	Llanta permitida	Cámara de aire (Código)	Volumen interno al 75% (litros)	Profundidad de la banda de rodamiento (mm)				
32	1050/50 R32 184A8/184B TL T2	829536	1040	1856	831	5510	36.00VA		Joint OR2052	1159	41				
Bar	1.0	1.3	1.6	1.9	2.2	2.3	2.4	2.5	2.6	2.7	2.8	2.9	3.2	3.5	3.8
Psi	15	19	23	28	32	33	35	36	38	39	41	42	46	51	55
10 km/h Cyc	6800	8330	9860	10710	11475	11730	11985	12240	12495	12750	13005	13260	14025	14665	15300
30 km/h Cyc	6240	7370	8500	9045	9695	9910	10125	10380	10630	10885	11140	11390	12150	12825	13500
25 km/h	5135	6065	6995	7495	7995	8160	8325	8535	8745	8950	9160	9370	9990		
30 km/h	4950	5845	6740	7220	7705	7865	8025	8225	8430	8630	8830	9030	9630		
40 km/h	4625	5465	6300	6750	7200	7350	7500	7690	7875	8065	8250	8440	9000		
50 km/h	4625	5465	6300	6750	7200	7350	7500	7690	7875	8065	8250	8440	9000		

Ø Pulgadas	Descripción	CAI	S mm	D mm	R' mm	Cdr. mm	Llanta recomendada	Llanta permitida	Cámara de aire (Código)	Volumen interno al 75% (litros)	Profundidad de la banda de rodamiento (mm)				
32	900/60 R32 181A8/181B TL	824122	868	1894	850	5626	DW27B (A)	DW30B (A)	831	1033	56				
Bar	1.0	1.3	1.6	1.9	2.2	2.3	2.4	2.5	2.6	2.7	2.8	2.9	3.2	3.5	3.8
Psi	15	19	23	28	32	33	35	36	38	39	41	42	46	51	55
10 km/h Cyc	6375	7695	9010	9775	10540	10795	11050	11305	11560	11815	12070	12265	12850	13440	14025
10 km/h**	5625	6675	7725	8485	9245	9495	9750	9975	10200	10425	10650	10825	11340	11860	12375
25 km/h	4720	5580	6440	6980	7520	7700	7880	8060	8245	8425	8605	8745	9160		
30 km/h	4550	5380	6205	6725	7250	7420	7595	7770	7945	8120	8295	8430	8830		
50 km/h	4250	5025	5800	6290	6775	6940	7100	7265	7425	7590	7750	7875	8250		

Ø Pulgadas	Descripción	CAI	S mm	D mm	R' mm	Cdr. mm	Llanta recomendada	Llanta permitida	Cámara de aire (Código)	Volumen interno al 75% (litros)	Profundidad de la banda de rodamiento (mm)				
32	1050/50 R32 178A8 TL M28	236234	1038	1902	854	5649	36.00VA		Joint OR2052	1250	60				
Bar	1.0	1.3	1.6	1.9	2.2	2.3	2.4	2.5	2.6	2.7	2.8	2.9	3.2	3.5	3.8
Psi	15	19	23	28	32	33	35	36	38	39	41	42	46	51	55
10 km/h Cyc	7420	8630	9840	10635	11425	11690	11955	12220	12485	12750					
15 km/h Cyc	5350	6675	8000	9330	10390	10700	11010	11165	11320	11475	11630				
10 km/h**	6860	7925	8990	9605	10225	10430	10635	10840	11045	11250					
25 km/h	5570	6505	7440	7775	8110	8220	8330								
30 km/h	5370	6270	7170	7495	7815	7925	8030								
40 km/h	5020	5860	6700	7000	7300	7400	7500								

* Consultar las notas al final de las tablas de esta gama.

MICHELIN® MEGAXBIB

Características y presiones en (Bar) y (Psi): carga por neumático en kg*

Ø Pulgadas	Descripción	CAI	S mm	D mm	R' mm	Cdr. mm	Llanta recomendada	Llanta permitida	Cámara de aire (Código)	Volumen interno al 75% (litros)	Profundidad de la banda de rodamiento (mm)
32	800/70 R32 181A8/181B TL	695992	793	1936	871	5725	DW27B (A)	DW25B (A)	831	966	58
Bar	1.0 1.3 1.6 1.9 2.2 2.3 2.4 2.5 2.6 2.7 2.8 2.9 3.2 3.5 3.8										
Psi	15 19 23 28 32 33 35 36 38 39 41 42 46 51 55										
10 km/h Cyc	6375 7820 9265 9965 10625 10840 11050 11220 11390 11560 11730 11960 12650 13335 14025										
10 km/h**	5625 6675 7725 8830 9475 9615 9750 9900 10050 10200 10350 10555 11160 11770 12375										
20 km/h	5335 6360 7380 7795 8210 8345 8485 8695 8900 9110 9320 9525 10150										
25 km/h	4815 5740 6660 7035 7410 7535 7660 7850 8035 8225 8410 8600 9160										
30 km/h	4680 5550 6420 6780 7140 7260 7380 7560 7745 7925 8105 8285 8830										
40 km/h	4375 5190 6000 6340 6675 6790 6900 7070 7240 7405 7575 7745 8250										

Ø Pulgadas	Descripción	CAI	S mm	D mm	R' mm	Cdr. mm	Llanta recomendada	Llanta permitida	Cámara de aire (Código)	Volumen interno al 75% (litros)	Profundidad de la banda de rodamiento (mm)
34	620/75 R34 170A8/170B TL	325025	590	1814	821	5398	DW20B (A)	DW18L		612	46
Bar	1.0 1.3 1.6 1.9 2.2 2.3 2.4 2.5 2.6 2.7 2.8 2.9 3.2 3.5 3.8										
Psi	15 19 23 28 32 33 35 36 38 39 41 42 46 51 55										
10 km/h Cyc	5010 5565 6120 6680 7235 7420 7605 7790 7975 8160 8345 8530 9090 9645 10200										
10 km/h**	4560 5035 5510 5985 6465 6620 6780 6940 7095 7255 7415 7575 8050 8525 9000										
25 km/h	3710 4110 4515 4915 5320 5455 5585 5720 5855 5990 6125 6260 6660										
30 km/h	3580 3965 4355 4740 5130 5260 5385 5515 5645 5775 5905 6035 6420										
40 km/h	3350 3710 4075 4435 4795 4915 5035 5155 5275 5400 5520 5640 6000										
50 km/h	3350 3710 4075 4435 4795 4915 5035 5155 5275 5400 5520 5640 6000										

Ø Pulgadas	Descripción	CAI	S mm	D mm	R' mm	Cdr. mm	Llanta recomendada	Llanta permitida	Cámara de aire (Código)	Volumen interno al 75% (litros)	Profundidad de la banda de rodamiento (mm)
34	710/75 R34 178A8/178B TL	543107	690	1900	848	5637	DW23B (A)	DW21B (A) MW23B (A)	765	863	58
Bar	1.0 1.3 1.6 1.9 2.2 2.3 2.4 2.5 2.6 2.7 2.8 2.9 3.2 3.5 3.8										
Psi	15 19 23 28 32 33 35 36 38 39 41 42 46 51 55										
10 km/h Cyc	6260 6955 7650 8345 9040 9275 9505 9735 9970 10200 10430 10665 11360 12055 12750										
10 km/h**	5700 6295 6890 7485 8080 8275 8475 8675 8870 9070 9270 9465 10060 10655 11250										
25 km/h	4650 5150 5655 6155 6655 6825 6990 7160 7325 7495 7660 7830 8330										
30 km/h	4480 4965 5450 5930 6415 6580 6740 6900 7060 7225 7385 7545 8030										
40 km/h	4190 4640 5095 5545 5995 6145 6295 6445 6595 6750 6900 7050 7500										
50 km/h	4190 4640 5095 5545 5995 6145 6295 6445 6595 6750 6900 7050 7500										

* Consultar las notas al final de las tablas de esta gama.

MICHELIN® MEGAXBIB

Características y presiones en (Bar) y (Psi): carga por neumático en kg*

Ø Pulgadas	Descripción	CAI	S mm	D mm	R' mm	Cdr. mm	Llanta recomendada	Llanta permitida	Cámara de aire (Código)	Volumen interno al 75% (litros)	Profundidad de la banda de rodamiento (mm)
38	620/70 R38 170A8/170B TL	476088	608	1864	850	5557	DW20B (A)	DW18L	825	587	55
Bar	1.0 1.3 1.6 1.9 2.2 2.3 2.4 2.5 2.6 2.7 2.8										
Psi	15 19 23 28 32 33 35 36 38 39 41										
10 km/h Cyc	5010 5565 6120 6680 7235 7420 7605 7790 7975 8160 8345 8530 9090 9645 10200										
10 km/h**	4560 5035 5510 5985 6465 6620 6780 6940 7095 7255 7415 7575 8050 8525 9000										
25 km/h	3710 4110 4515 4915 5320 5455 5585 5720 5855 5990 6125 6260 6660										
30 km/h	3580 3965 4355 4740 5130 5260 5385 5515 5645 5775 5905 6035 6420										
40 km/h	3350 3710 4075 4435 4795 4915 5035 5155 5275 5400 5520 5640 6000										
50 km/h	3350 3710 4075 4435 4795 4915 5035 5155 5275 5400 5520 5640 6000										

Ø Pulgadas	Descripción	CAI	S mm	D mm	R' mm	Cdr. mm	Llanta recomendada	Llanta permitida	Cámara de aire (Código)	Volumen interno al 75% (litros)	Profundidad de la banda de rodamiento (mm)
38	650/85R38 173A8/173B TL	173491	698.5	2048	931	6100	DW23B (A)	DW20B (A)	804	857	63
Bar	1 1.3 1.6 1.9 2.2 2.3 2.4 2.5 2.6 2.7 2.8										
Psi	15 19 23 28 32 33 35 36 38 39 41										
10 km/h**	5815 6660 7500 8065 8625 8815 9000 9190 9375 9565 9750										
10 km/h Cyc Dual	5610 6545 7480 8040 8600 8790 8975 9165 9350 9535 9724										
25 km/h	4440 5245 6050 6485 6925 7070 7215										
30 km/h	4280 5055 5830 6250 6675 6815 6955										
40 km/h	4000 4725 5450 5845 6240 6370 6500										
50 km/h	4000 4725 5450 5845 6240 6370 6500										

Ø Pulgadas	Descripción	CAI	S mm	D mm	R' mm	Cdr. mm	Llanta recomendada	Llanta permitida	Cámara de aire (Código)	Volumen interno al 75% (litros)	Profundidad de la banda de rodamiento (mm)
42	520/85 R42 162A8/162B TL	645194	537	1937	889	5783	DW18L	DD18W18L	802	545	56
Bar	1.0 1.3 1.6 1.9 2.2 2.3 2.4 2.5 2.6 2.7 2.8 2.9 3.2 3.5 3.8										
Psi	15 19 23 28 32 33 35 36 38 39 41 42 46 51 55										
10 km/h Cyc Dual	3850 4575 5300 6170 6500 6620 6740 6865 6985 7105										
10 km/h**	3990 4900 5810 6395 6830 6975 7070 7170 7265 7360										
25 km/h	3330 3955 4580 4890 5135 5205 5275										
30 km/h	3210 3815 4415 4715 4950 5020 5085										
50 km/h	3000 3565 4125 4405 4625 4690 4750										
30 km/h Dual	2825 3355 3885 4150 4355 4415 4475										

* Consultar las notas al final de las tablas de esta gama.

MICHELIN® MEGAXBIB

Características y presiones en (Bar) y (Psi): carga por neumático en kg*

Ø Pulgadas	Descripción	CAI	S mm	D mm	R' mm	Cdr. mm	Llanta recomendada	Llanta permitida	Cámara de aire (Código)	Volumen interno al 75% (litros)	Profundidad de la banda de rodamiento (mm)
42	620/70 R42 166A8/166B TL	100268	639	1961	885	5857	DW20B (A)	DW18L MW20B (A)	802	658	56
Bar	1.0 1.3 1.6 1.9 2.2 2.3 2.4 2.5 2.6 2.7 2.8 2.9 3.2 3.5 3.8										
Psi	15 19 23 28 32 33 35 36 38 39 41 42 46 51 55										
10 km/h Cyc Dual	4080 4875 5670 6465 7030 7180 7330 7480 7630 7780 7930										
10 km/h**	4090 4890 5685 6485 7050 7200 7350 7500 7650 7800 7950										
40 km/h	3250 3875 4500 4800 5100 5200 5300										
50 km/h	3250 3875 4500 4800 5100 5200 5300										
30 km/h Dual	3060 3650 4240 4520 4805 4895 4990										

***IMPORTANTE:**

La presión de inflado se determina siempre en función de la carga por neumático, de la velocidad y del trabajo a realizar. Las recomendaciones anteriores se facilitan con la salvedad de modificaciones posteriores a la fecha de difusión de estas tablas (junio de 2018). Los datos técnicos pueden sufrir modificaciones sin previo aviso.

- Para máquinas autonivelantes o que trabajan en pendientes superiores al 20% (11°), usar la curva no cíclica a 10 km/h.
 - Para uso en carreteras pesadas que exceden el 50%, agregue 0.4 Bar.
 - Carga cíclica de 10, 15 o 30 km/h, usar solo en el campo, viajando con carga completa que no exceda los 1.5 km.
- **10 km/h LT (torque bajo) (velocidad máxima 10 km/h).



MICHELIN® SPRAYBIB

ALTA CAPACIDAD
DE CARGA PARA
ASPERSORAS DE ALTO
DESPEJE



PARA ASPERSORAS DE ALTO DESPEJE



VERY HIGH FLEXION (VF)



PRODUCTIVIDAD

- +16%⁽¹⁾ de carga frente a un neumático IF para la misma presión



PROTECCIÓN A LOS SUELOS

- 25%⁽¹⁾ menos presión de aire para la misma carga que un neumático IF



COMODIDAD

- Máxima estabilidad a altas velocidades (hasta 65 km/h)



(1) Prueba interna 2015 (Ladoux - Francia).

DIMENSIONES

VF 380/80 R38 167D TL

VF 320/90 R42 163D TL

VF 480/80 R42 176D TL

VF 320/90R46 165D TL **NUEVO**

VF 380/90 R46 173D TL

VF 480/80 R46 177D TL

VF 320/90 R50 166D TL

VF 380/90 R50 175D TL

VF 480/80 R50 179D TL

VF 420/95 R50 177D TL

VF 320/90 R54 168D TL

VF 380/90 R54 176D TL

MICHELIN® SPRAYBIB

Características y presiones en (Bar) y (Psi): carga por neumático en kg*

Ø Pulgadas	Descripción	CAI	S mm	D mm	R' mm	Cdr. mm	Llanta recomendada	Llanta permitida	Cámara de aire (Código)	Volumen interno al 75% (litros)	Profundidad de la banda de rodamiento (mm)		
38	VF 380/80 R38 167D TL	352109	382	1577	726	4712	DW13	DW12	795	231	38		
Bar	1.8 2.0 2.2 2.4 2.6 2.8 3.0 3.2 3.4 3.6 3.8 4.0 4.2 4.4												
Psi	26 29 32 35 38 41 44 46 49 52 55 58 61 64												
65 km/h		3650	3750	3940	4125	4315	4500	4625	4750	4875	5000	5225	5450

Ø Pulgadas	Descripción	CAI	S mm	D mm	R' mm	Cdr. mm	Llanta recomendada	Llanta permitida	Cámara de aire (Código)	Volumen interno al 75% (litros)	Profundidad de la banda de rodamiento (mm)		
42	VF 320/90 R42 163D TL	920383	322	1645	763	4922	DW11	DW10		195			
Bar	1.8 2.0 2.2 2.4 2.6 2.8 3.0 3.2 3.4 3.6 3.8 4.0 4.2 4.4												
Psi	26 29 32 35 38 41 44 46 49 52 55 58 61 64												
65 km/h		3250	3350	3500	3650	3825	4000	4125	4250	4405	4565	4720	4875

Ø Pulgadas	Descripción	CAI	S mm	D mm	R' mm	Cdr. mm	Llanta recomendada	Llanta permitida	Cámara de aire (Código)	Volumen interno al 75% (litros)	Profundidad de la banda de rodamiento (mm)
42	VF 480/80 R42 176D TL	929553	489	1838	833	5471	DW16A	DD16W16A	801	420	38
Bar	1.8 2.0 2.2 2.4 2.6 2.8 3.0 3.2 3.4 3.6 3.8 4.0 4.2 4.4										
Psi	26 29 32 35 38 41 44 46 49 52 55 58 61 64										
65 km/h		5000	5200	5400	5600	5875	6150	6425	6700	6900	7100

Ø Pulgadas	Descripción	CAI	S mm	D mm	R' mm	Cdr. mm	Llanta recomendada	Llanta permitida	Cámara de aire (Código)	Volumen interno al 75% (litros)	Profundidad de la banda de rodamiento (mm)		
46	VF 320/90R46 165D TL NUEVO	684579	318	1736	810	5350	DW10		835	211	37		
Bar	2.2 2.4 2.6 2.8 3 3.2 3.4 3.6 3.8 4 4.2 4.4												
Psi	32 35 38 41 44 46 49 52 55 58 61 64												
65 km/h		3450	3550	3715	3875	4000	4125	4315	4500	4665	4825	4990	5150

Ø Pulgadas	Descripción	CAI	S mm	D mm	R' mm	Cdr. mm	Llanta recomendada	Llanta permitida	Cámara de aire (Código)	Volumen interno al 75% (litros)	Profundidad de la banda de rodamiento (mm)		
46	VF 380/90 R46 173D TL	198604	383	1842	848	5530	DW13A	DW12A W12 W12A W13 W13A	835	308	38		
Bar	1.8 2.0 2.2 2.4 2.6 2.8 3.0 3.2 3.4 3.6 3.8 4.0 4.2 4.4												
Psi	26 29 32 35 38 41 44 46 49 52 55 58 61 64												
65 km/h		4375	4625	4815	5000	5225	5450	5625	5800	5900	6000	6250	6500

* Consultar las notas al final de las tablas de esta gama.

MICHELIN® SPRAYBIB

Características y presiones en (Bar) y (Psi): carga por neumático en kg*

Ø Pulgadas	Descripción	CAI	S mm	D mm	R' mm	Cdr. mm	Llanta recomendada	Llanta permitida	Cámara de aire (Código)	Volumen interno al 75% (litros)	Profundidad de la banda de rodamiento (mm)
46	VF 480/80 R46 177D TL	159186	485	1943	885	5790	DW16A (L)	DW15L DW16B W16A	834	449	38
Bar	1.8 2.0 2.2 2.4	2.6 2.8 3.0 3.2 3.4 3.6 3.8	4.0 4.2 4.4								
Psi	26 29 32 35	38 41 44 46 49 52 55	58 61 64								
65 km/h	5300 5465 5635 5800	6075 6350 6625 6900	7100 7300								

Ø Pulgadas	Descripción	CAI	S mm	D mm	R' mm	Cdr. mm	Llanta recomendada	Llanta permitida	Cámara de aire (Código)	Volumen interno al 75% (litros)	Profundidad de la banda de rodamiento (mm)
50	VF 320/90 R50 166D TL	946508	320	1850	866	5682	DW11	DW10 W10 W11	816	209	36
Bar	1.8 2.0 2.2 2.4	2.6 2.8 3.0 3.2 3.4 3.6 3.8	4.0 4.2 4.4								
Psi	26 29 32 35	38 41 44 46 49 52 55	58 61 64								
65 km/h	3650 3750 3875 4000	4190 4375 4500 4625 4795	4965 5130 5300								

Ø Pulgadas	Descripción	CAI	S mm	D mm	R' mm	Cdr. mm	Llanta recomendada	Llanta permitida	Cámara de aire (Código)	Volumen interno al 75% (litros)	Profundidad de la banda de rodamiento (mm)
50	VF 380/90 R50 175D TL	722276	384	1951	903	5836	DW13B	DW12A W12A W12B W13A W13B		329	38
Bar	1.8 2.0 2.2 2.4	2.6 2.8 3.0 3.2 3.4 3.6 3.8	4.0 4.2 4.4								
Psi	26 29 32 35	38 41 44 46 49 52 55	58 61 64								
65 km/h	4625 4750 4950 5150	5375 5600 5800 6000 6150	6300 6600 6900								

Ø Pulgadas	Descripción	CAI	S mm	D mm	R' mm	Cdr. mm	Llanta recomendada	Llanta permitida	Cámara de aire (Código)	Volumen interno al 75% (litros)	Profundidad de la banda de rodamiento (mm)
50	VF 480/80 R50 179D TL	431251	485	2045	935	6101	DW16A(L)	DW15B (A) DW15L DW16B W15B (A) W16B		479	38
Bar	1.8 2.0 2.2 2.4	2.6 2.8 3.0 3.2 3.4 3.6 3.8	4.0 4.2 4.4								
Psi	26 29 32 35	38 41 44 46 49 52 55	58 61 64								
65 km/h	5450 5685 5915 6150	6440 6725 7015 7300 7525	7750								

Ø Pulgadas	Descripción	CAI	S mm	D mm	R' mm	Cdr. mm	Llanta recomendada	Llanta permitida	Cámara de aire (Código)	Volumen interno al 75% (litros)	Profundidad de la banda de rodamiento (mm)
50	VF 420/95 R50 177D TL	085405	423	2052	937	6118	DW14B (A)	DW13B (A) W13B (A) W14B (A)		440	38
Bar	1.8 2.0 2.2 2.4	2.6 2.8 3.0 3.2 3.4 3.6 3.8	4.0 4.2 4.4								
Psi	26 29 32 35	38 41 44 46 49 52 55	58 61 64								
65 km/h	5150 5365 5585 5800	6075 6350 6625 6900 7100	7300								

* Consultar las notas al final de las tablas de esta gama.

MICHELIN® SPRAYBIB

Características y presiones en (Bar) y (Psi): carga por neumático en kg*

Ø Pulgadas	Descripción	CAI	S mm	D mm	R' mm	Cdr. mm	Llanta recomendada	Llanta permitida	Cámara de aire (Código)	Volumen interno al 75% (litros)	Profundidad de la banda de rodamiento (mm)
54	VF 320/90 R54 168D TL	044008	323	1950	914	5851	DW11	DW10 W10 W11	816	240	36
Bar	1.8 2.0 2.2 2.4 2.6 2.8 3.0 3.2 3.4 3.6 3.8 4.0 4.2 4.4										
Psi	26 29 32 35 38 41 44 46 49 52 55 58 61 64										
65 km/h		3750 3875 4065 4250 4440 4625 4750 4875 5055 5240 5420 5600									

Ø Pulgadas	Descripción	CAI	S mm	D mm	R' mm	Cdr. mm	Llanta recomendada	Llanta permitida	Cámara de aire (Código)	Volumen interno al 75% (litros)	Profundidad de la banda de rodamiento (mm)
54	VF 380/90 R54 176D TL	816598	384	2049	950	6131	DW13A	W12A		350	37
Bar	1.8 2.0 2.2 2.4 2.6 2.8 3.0 3.2 3.4 3.6 3.8 4.0 4.2 4.4										
Psi	26 29 32 35 38 41 44 46 49 52 55 58 61 64										
65 km/h		4875 5000 5190 5375 5565 5750 5940 6125 6315 6500 6800 7100									

***IMPORTANTE:**

La presión de inflado se determina siempre en función de la carga por neumático, de la velocidad y del trabajo a realizar. Las recomendaciones anteriores se facilitan con la salvedad de modificaciones posteriores a la fecha de difusión de estas tablas (junio de 2018). Los datos técnicos pueden sufrir modificaciones sin previo aviso.

- Para uso en laderas: añadir 0.4 Bar.
- Para uso intensivo en carretera: añadir 0.4 Bar.



MICHELIN® AGRIBIB ROW CROP

DISEÑADO ESPECIALMENTE
PARA UNA EXCELENTE
TRACCIÓN EN LOS CULTIVOS
EN LÍNEA



PARA MAQUINARIA DE ASPERSORAS Y ALTO
DESPEJE



TRACCIÓN



PROTECCIÓN DE LOS CULTIVOS



DIMENSIONES

320/85 R38 143A8/143B TL

320/90 R42 147A8/147B TL

340/85 R46 150A8/150B TL

380/90 R46 157A8/157B TL

320/90 R50 150A8/150B TL

380/90 R50 151A8/151B TL

IF 380/90R50 167A8/167B TL **NUEVO**

320/90 R54 151A8/151B TL

MICHELIN® AGRIBIB ROW CROP

Características y presiones en (Bar) y (Psi): carga por neumático en kg*

Ø Pulgadas	Descripción	CAI	S mm	D mm	R' mm	Cdr. mm	Llanta recomendada	Llanta permitida	Cámara de aire (Código)	Volumen interno al 75% (litros)	Profundidad de la banda de rodamiento (mm)			
38	320/85 R38 143A8/143B TL	758001	315	1508	699	4514	W10	DW10A DW11A W11	779	170	42			
Bar	1.2 1.4 1.6 1.8 2.0 2.2 2.4 2.6 2.8 3.0 3.2 3.4 3.6 3.8 4.0													
Psi	17 20 23 26 29 32 35 38 41 44 46 49 52 55 58													
10 km/h Cyc		2330	2520	2710	2900	3090	3205	3315	3430	3540	3700	3860	3975	4090
25 km/h Cyc	1890 2075	2260	2360	2460	2560	2660	2780	2900	3020	3140	3230	3320		
30 km/h Cyc	1770 1940	2110	2205	2300	2395	2490	2605	2715	2830	2940	3025	3110		
25 km/h	1720 1885	2050	2145	2235	2330	2420	2530	2640	2750	2860	2940	3020		
30 km/h	1660 1820	1980	2070	2155	2245	2330	2440	2545	2655	2760	2840	2920		
50 km/h	1550 1700	1850	1935	2015	2100	2180	2280	2380	2475	2575	2650	2725		

Ø Pulgadas	Descripción	CAI	S mm	D mm	R' mm	Cdr. mm	Llanta recomendada	Llanta permitida	Cámara de aire (Código)	Volumen interno al 75% (litros)	Profundidad de la banda de rodamiento (mm)			
42	320/90 R42 147A8/147B TL	425361	312	1638	764	4908	DW10L	W10L W9L		197	42			
Bar	1.2 1.4 1.6 1.8 2.0 2.2 2.4 2.6 2.8 3.0 3.2 3.4 3.6 3.8 4.0													
Psi	17 20 23 26 29 32 35 38 41 44 46 49 52 55 58													
10 km/h Cyc		2850	3025	3195	3370	3540	3650	3760	3865	3975	4165	4350	4480	4610
25 km/h Cyc	2075 2295	2510	2625	2740	2850	2965	3110	3255	3395	3540	3645	3750		
30 km/h Cyc	1940 2225	2510	2575	2640	2705	2770	2905	3040	3170	3305	3405	3505		
25 km/h	1890 2090	2290	2395	2495	2600	2700	2830	2960	3090	3220	3320	3415		
30 km/h	1820 2010	2200	2300	2400	2500	2600	2725	2850	2975	3100	3195	3290		
50 km/h	1700 1880	2060	2155	2245	2340	2430	2550	2665	2785	2900	2990	3075		

Ø Pulgadas	Descripción	CAI	S mm	D mm	R' mm	Cdr. mm	Llanta recomendada	Llanta permitida	Cámara de aire (Código)	Volumen interno al 75% (litros)	Profundidad de la banda de rodamiento (mm)			
46	340/85 R46 150A8/150B TL (13.6 R46)	846786	338	1747	810	5227	W12	DW10A W10 W12A	835	225	41			
Bar	1.2 1.4 1.6 1.8 2.0 2.2 2.4 2.6 2.8 3.0 3.2 3.4 3.6 3.8 4.0													
Psi	17 20 23 26 29 32 35 38 41 44 46 49 52 55 58													
10 km/h Cyc		2780	3025	3265	3510	3750	3900	4050	4200	4350	4540	4730	4880	5030
25 km/h Cyc	2260 2495	2730	2855	2980	3105	3230	3385	3535	3690	3840	3965	4090		
30 km/h Cyc	2110 2330	2550	2670	2785	2905	3020	3165	3305	3450	3590	3705	3820		
25 km/h	2050 2270	2490	2605	2715	2830	2940	3080	3220	3360	3500	3610	3720		
30 km/h	1980 2190	2400	2510	2620	2730	2840	2975	3105	3240	3370	3475	3580		
50 km/h	1850 2045	2240	2345	2445	2550	2650	2775	2900	3025	3150	3250	3350		

* Consultar las notas al final de las tablas de esta gama.

MICHELIN® AGRIBIB ROW CROP

Características y presiones en (Bar) y (Psi): carga por neumático en kg*

Ø Pulgadas	Descripción	CAI	S mm	D mm	R' mm	Cdr. mm	Llanta recomendada	Llanta permitida	Cámara de aire (Código)	Volumen interno al 75% (litros)	Profundidad de la banda de rodamiento (mm)			
46	380/90 R46 157A8/157B TL (14.9 R46)	799905	401	1864	867	5583	W13A	DW13 DW13A W12 W12A W13	835	308	46			
Bar	1.2 1.4 1.6 1.8 2.0 2.2 2.4 2.6 2.8 3.0 3.2 3.4 3.6 3.8 4.0													
Psi	17 20 23 26 29 32 35 38 41 44 46 49 52 55 58													
10 km/h Cyc		3450	3740	4030	4320	4610	4790	4970	5150	5330	5570	5810	6000	6190
25 km/h Cyc	2810 3115	3420	3560	3695	3835	3970	4160	4350	4540	4730	4880	5030		
30 km/h Cyc	2620 2905	3190	3320	3450	3580	3710	3890	4065	4245	4420	4560	4700		
25 km/h	2550 2830	3110	3235	3360	3485	3610	3785	3955	4130	4300	4440	4580		
30 km/h	2460 2730	3000	3120	3240	3360	3480	3650	3815	3985	4150	4280	4410		
50 km/h	2300 2550	2800	2915	3025	3140	3250	3405	3565	3720	3875	4000	4125		

Ø Pulgadas	Descripción	CAI	S mm	D mm	R' mm	Cdr. mm	Llanta recomendada	Llanta permitida	Cámara de aire (Código)	Volumen interno al 75% (litros)	Profundidad de la banda de rodamiento (mm)			
50	320/90 R50 150A8/150B TL	130813	314	1847	862	5539	W10	DW10A W10A	816	226	39			
Bar	1.2 1.4 1.6 1.8 2.0 2.2 2.4 2.6 2.8 3.0 3.2 3.4 3.6 3.8 4.0													
Psi	17 20 23 26 29 32 35 38 41 44 46 49 52 55 58													
10 km/h Cyc		2780	3025	3265	3510	3750	3900	4050	4200	4350	4540	4730	4880	5030
25 km/h Cyc	2260 2495	2730	2855	2980	3105	3230	3385	3535	3690	3840	3965	4090		
30 km/h Cyc	2110 2330	2550	2670	2785	2905	3020	3165	3305	3450	3590	3705	3820		
25 km/h	2050 2270	2490	2605	2715	2830	2940	3080	3220	3360	3500	3610	3720		
30 km/h	1980 2190	2400	2510	2620	2730	2840	2975	3105	3240	3370	3475	3580		
50 km/h	1850 2045	2240	2345	2445	2550	2650	2775	2900	3025	3150	3250	3350		

Ø Pulgadas	Descripción	CAI	S mm	D mm	R' mm	Cdr. mm	Llanta recomendada	Llanta permitida	Cámara de aire (Código)	Volumen interno al 75% (litros)	Profundidad de la banda de rodamiento (mm)
50	380/90 R50 151A8/151B TL	036849	393	1935	912	5813	DW13A	DW12A W12A W13A		329	47
Bar	1.2 1.4 1.6 1.8 2.0 2.2 2.4 2.6 2.8 3.0 3.2 3.4 3.6 3.8 4.0										
Psi	17 20 23 26 29 32 35 38 41 44 46 49 52 55 58										
10 km/h Cyc		3540	3945	4350	4555	4765	4970	5175			
25 km/h Cyc	2880 3210	3540	3710	3875	4045	4210					
30 km/h Cyc	2690 3000	3305	3465	3620	3780	3935					
25 km/h	2620 2920	3220	3375	3525	3680	3830					
30 km/h	2525 2815	3100	3250	3395	3545	3690					
50 km/h	2360 2630	2900	3040	3175	3315	3450					

* Consultar las notas al final de las tablas de esta gama.

MICHELIN® AGRIBIB ROW CROP

Características y presiones en (Bar) y (Psi): carga por neumático en kg*

Ø Pulgadas	Descripción	CAI	S mm	D mm	R' mm	Cdr. mm	Llanta recomendada	Llanta permitida	Cámara de aire (Código)	Volumen interno al 75% (litros)	Profundidad de la banda de rodamiento (mm)
50	IF 380/90R50 167A8/167B TL NUEVO	212359	395	1953	903	5841	DW13A	DW12A W12A W13A		329	47
Bar	1.2 1.4 1.6 1.8 2 2.2 2.4 2.6 2.8 3 3.2 3.4 3.6 3.8 4										
Psi	17 20 23 26 29 32 35 38 41 44 46 49 52 55 58										
10 km/h**	3200 3500 3800 4040 4275 4415 4550 4750 4950 5165 5375 5525 5675 5840 6000										
20 km/h	3125 3425 3725 3950 4175 4315 4450 4650 4850 5065 5275 5415 5550 5715 5875										
30 km/h	3025 3315 3600 3815 4025 4165 4300 4490 4675 4875 5075 5215 5350 5515 5675										
50 km/h	2900 3175 3450 3665 3875 4000 4125 4315 4500 4690 4875 5015 5150 5300 5450										

Ø Pulgadas	Descripción	CAI	S mm	D mm	R' mm	Cdr. mm	Llanta recomendada	Llanta permitida	Cámara de aire (Código)	Volumen interno al 75% (litros)	Profundidad de la banda de rodamiento (mm)
54	320/90 R54 151A8/151B TL	272304	315	1950	915	5852	W10		816	240	39
Bar	1.2 1.4 1.6 1.8 2.0 2.2 2.4 2.6 2.8 3.0 3.2 3.4 3.6 3.8 4.0										
Psi	17 20 23 26 29 32 35 38 41 44 46 49 52 55 58										
10 km/h Cyc	2930 3165 3395 3630 3860 4020 4180 4340 4500 4690 4880 5030 5180										
25 km/h Cyc	2380 2630 2880 2990 3100 3210 3320 3485 3645 3810 3970 4090 4210										
30 km/h Cyc	2220 2455 2690 2795 2900 3005 3110 3260 3410 3560 3710 3820 3930										
25 km/h	2160 2390 2620 2720 2820 2920 3020 3170 3315 3465 3610 3720 3830										
30 km/h	2090 2310 2530 2630 2725 2825 2920 3060 3200 3340 3480 3585 3690										
50 km/h	1950 2155 2360 2450 2545 2635 2725 2855 2990 3120 3250 3350 3450										

***IMPORTANTE:**

La presión de inflado se determina siempre en función de la carga por neumático, de la velocidad y del trabajo a realizar. Las recomendaciones anteriores se facilitan con la salvedad de modificaciones posteriores a la fecha de difusión de estas tablas (junio de 2018). Los datos técnicos pueden sufrir modificaciones sin previo aviso.

- Para uso en laderas: añadir 0.4 Bar, sin exceder la presión máxima del neumático.
 - Para uso intensivo en carretera: añadir 0.4 Bar.
 - Utilice tablas de carga cíclica de 10, 25 o 30 km/h solo para uso en campo, viajando a plena carga sin exceder 1.5 km/h.
- **10 km/h LT (torque bajo) (velocidad máxima 10 km/h).



NUEVO



MICHELIN[®] TRAILXBIB

**MAYOR VIDA PARA LOS
NEUMÁTICOS DE SU
REMOLQUE**



TECNOLOGÍA VF MICHELIN[®] ULTRAFLEX

- Baja compactación del suelo
- Rendimientos optimizados



EXCELENTE RESISTENCIA

- Recubrimiento NUEVO VF diseñado para robustez e impacto de baja presión
- Casco reforzado de acero



AUTOLIMPIEZA

- Diseño de casco estándar específico
- Gajos amplios y divergentes



DISEÑADO PARA UNA LARGA DURACIÓN DE LOS NEUMÁTICOS

- Impactos limitados gracias al alto ángulo de incidencia
- Más caucho para usar



EXCELENTE CONDUCCIÓN EN CARRETERAS

- RIB central para robustez
- Compatibilidad con CTIS para optimizar la presión en la carretera y en el campo

DIMENSIONES

VF 560/60R22.5 IMP 166D TL **NUEVO**

MICHELIN® TRAILXBIB

Características y presiones en (Bar) y (Psi): carga por neumático en kg*

Ø Pulgadas	Descripción	CAI	S mm	D mm	R' mm	Cdr. mm	Llanta recomendada		Llanta permitida	Cámara de aire (Código)	Volumen interno al 75% (litros)	Profundidad de la banda de rodamiento (mm)
22.5	VF 560/60R22.5 IMP 166D TL NUEVO	103824	542	1242	507	3612	AG16.00 (H2)		16.00 AG20.00 (H2) 17.00 AG18.00		263	19
Bar	0.8	0.9	1	1.2	1.5	1.8	2.1	2.4	2.7	3	3.2	
Psi	12	13	15	17	22	26	30	35	39	44	46	
10 km/h**	3725	3975	4250	4775	5575	6375	6950	7050	7750	8400	8700	
25 km/h	3300	3550	3775	4250	4950	5675	6200	6275	6900	7475	7750	
40 km/h	2925	3125	3350	3750	4375	5000	5475	5550	6100	6600	6825	
50 km/h	2650	2850	3025	3400	3975	4550	4975	5025	5525	6000	6200	
65 km/h	2275	2440	2600	2925	3400	3825	4250	4300	4725	5125	5300	

***IMPORTANTE:**

• La presión de inflado debe ser siempre adecuada para la carga por neumático, la velocidad de desplazamiento y el trabajo a realizar. Nuestras recomendaciones anteriores se proporcionan sujetas a cambios realizados después de la fecha de publicación de estas tablas (julio de 2020). Características técnicas están sujetas a cambios sin previo aviso.

- Agregue 0.4 Bar para usar en pendientes de más del 20%.
 - Agregue 0.4 Bar para uso intensivo en carretera, superando el 50% del tiempo en carretera.
- **10 km/h LT (torque bajo) (velocidad máxima 10 km/h).



MICHELIN® CARGOXBIB HIGH FLOTATION

EL NEUMÁTICO DE BAJA
PRESIÓN ESPECIAL PARA
REMOLQUES QUE PROTEJE
LOS SUELOS



El mejor rendimiento **DESDE LA CARRETERA
HASTA EL CAMPO**



PROTECCIÓN A LOS SUELOS

Gracias a su baja presión que va desde 0.8 Bar y +37% de huella⁽¹⁾



Hasta 3 veces más **CAPACIDAD AUTOLIMPIANTE QUE
GARANTIZA TRACCIÓN EN SUELOS HÚMEDOS**



Excelente **COMPORTAMIENTO EN CARRETERA**

(1) Estudios internos del Centro de Tecnología de Michelin realizados en abril de 2012/junio 2013.

DIMENSIONES

710/45 R22.5 165D TL

28 LR 26 175D TL

710/50 R26.5 170D TL

VF 710/50 R26,5 176D IMP TL

600/55 R26.5 165D TL

650/55 R26.5 169D TL

VF 600/55 R26,5 170D IMP TL

VF 650/55R26.5 IMP 174D TL **NUEVO**

750/60 R30.5 181D TL

VF 750/60 R30.5 187D IMP TL

650/65 R30.5 176D TL

800/60 R32 185D IMP TL

MICHELIN® CARGOXBIB HIGH FLOTATION

Características y presiones en (Bar) y (Psi): carga por neumático en kg*

Ø Pulgadas	Descripción	CAI	S mm	D mm	R' mm	Cdr. mm	Llanta recomendada	Llanta permitida	Cámara de aire (Código)	Volumen interno al 75% (litros)	Profundidad de la banda de rodamiento (mm)
22.5	710/45 R22.5 165D TL	723051	723	1208	514	3545	AG24.00 (H2)	AG20.00 (H2)		317	16
Bar	0.8 0.9 1.0 1.2 1.5 1.8 2.1 2.4 2.7 3.0 3.2 3.4 3.6 3.8 4.0										
Psi	12 13 15 17 22 26 30 35 39 44 46 49 52 55 58										
10 km/h**	2970 3430 3890 4325 4970 5620 6270 6920 7360 7800 8095 8390 8685 8975 9270										
25 km/h	2610 2930 3250 3650 4255 4855 5460 6060 6450 6840 7100 7360 7620 7880 8140										
40 km/h	2250 2525 2800 3145 3665 4185 4700 5220 5555 5890 6110 6335 6555 6780 7000										
50 km/h	2000 2245 2490 2795 3260 3720 4180 4640 4940 5235 5435 5635 5835 6030 6230										
65 km/h	1650 1855 2060 2315 2695 3075 3460 3840 4085 4330 4495 4660 4825 4985 5150										

Ø Pulgadas	Descripción	CAI	S mm	D mm	R' mm	Cdr. mm	Llanta recomendada	Llanta permitida	Cámara de aire (Código)	Volumen interno al 75% (litros)	Profundidad de la banda de rodamiento (mm)
26	28 LR 26 175D TL (710/65 R26)	224829	740	1581	705	4685	DW25B (A)	DW23B (A)		577	26
Bar	0.8 0.9 1.0 1.2 1.5 1.8 2.1 2.4 2.7 3.0 3.2 3.4 3.6 3.8 4.0										
Psi	12 13 15 17 22 26 30 35 39 44 46 49 52 55 58										
15 km/h	3750 3935 4120 4615 5360 5905 6460 7035 7605 7905 8140 8375 8710 8980 9245										
25 km/h	3320 3485 3645 4085 4740 5220 5710 6220 6725 6990 7200 7405 7705 7940 8175										
40 km/h	3065 3215 3365 3770 4380 4825 5280 5750 6215 6460 6655 6845 7120 7340 7555										
50 km/h	2940 3085 3230 3620 4200 4625 5060 5515 5960 6195 6380 6565 6825 7035 7245										
65 km/h	2800 2940 3075 3445 4000 4405 4820 5250 5675 5900 6075 6250 6500 6700 6900										

Ø Pulgadas	Descripción	CAI	S mm	D mm	R' mm	Cdr. mm	Llanta recomendada	Llanta permitida	Cámara de aire (Código)	Volumen interno al 75% (litros)	Profundidad de la banda de rodamiento (mm)
26.5	710/50 R26.5 170D TL	892516	729	1380	594	4061	AG24.00 (H2)	AG20.00 (H2)		407	18
Bar	0.8 0.9 1.0 1.2 1.5 1.8 2.1 2.4 2.7 3.0 3.2 3.4 3.6 3.8 4.0										
Psi	12 13 15 17 22 26 30 35 39 44 46 49 52 55 58										
10 km/h**	3510 4205 4900 5450 6275 7100 7925 8750 9135 9520 9775 10030 10290 10545 10800										
25 km/h	3080 3610 4140 4645 5400 6155 6915 7670 8010 8350 8575 8800 9030 9255 9480										
40 km/h	2650 3130 3610 4040 4680 5325 5965 6610 6900 7190 7385 7580 7775 7965 8160										
50 km/h	2360 2780 3200 3585 4155 4730 5305 5880 6140 6400 6570 6745 6915 7090 7260										
65 km/h	1950 2315 2680 2990 3460 3925 4395 4860 5075 5290 5430 5575 5715 5860 6000										

* Consultar las notas al final de las tablas de esta gama.

MICHELIN® CARGOXBIB HIGH FLOTATION

Características y presiones en (Bar) y (Psi): carga por neumático en kg*

Ø Pulgadas	Descripción	CAI	S mm	D mm	R' mm	Cdr. mm	Llanta recomendada	Llanta permitida	Cámara de aire (Código)	Volumen interno al 75% (litros)	Profundidad de la banda de rodamiento (mm)
26.5	VF710/50 R26,5 176D IMP TL	343405	729	1380	600	3934	AG24.00 (H2)	AG20.00 (H2)		407	18
Bar	0.8 0.9 1.0 1.2 1.5 1.8 2.1 2.4 2.7 3.0 3.2 3.4 3.6 3.8 4.0										
Psi	12 13 15 17 22 26 30 35 39 44 46 49 52 55 58										
10 km/h**	4469 4768 5150 5822 6765 7503 8400 9184 10081 10988 11644										
25 km/h	3979 4245 4584 5183 6023 6680 7478 8176 8974 9782 10366										
40 km/h	3515 3750 4051 4580 5321 5902 6607 7224 7929 8643 9159										
50 km/h	3188 3402 3674 4154 4826 5353 5993 6552 7192 7839 8307										
65 km/h	2725 2930 3140 3550 4125 4575 5055 5600 6275 6700 7100										

Ø Pulgadas	Descripción	CAI	S mm	D mm	R' mm	Cdr. mm	Llanta recomendada	Llanta permitida	Cámara de aire (Código)	Volumen interno al 75% (litros)	Profundidad de la banda de rodamiento (mm)
26.5	600/55 R26,5 165D TL	550621	626	1341	581	3954	AG20.00 (H2)		716	312	17
Bar	0.8 0.9 1.0 1.2 1.5 1.8 2.1 2.4 2.7 3.0 3.2 3.4 3.6 3.8 4.0										
Psi	12 13 15 17 22 26 30 35 39 44 46 49 52 55 58										
10 km/h**	2970 3585 4200 4675 5380 6090 6800 7510 7840 8170 8390 8610 8830 9050 9270										
25 km/h	2610 3085 3560 3995 4640 5290 5940 6590 6880 7170 7365 7560 7755 7945 8140										
40 km/h	2250 2675 3100 3465 4020 4570 5120 5670 5920 6170 6335 6500 6670 6835 7000										
50 km/h	2000 2375 2750 3080 3570 4065 4555 5050 5270 5495 5640 5790 5935 6085 6230										
65 km/h	1650 1975 2300 2565 2970 3370 3770 4170 4355 4540 4660 4785 4905 5030 5150										

Ø Pulgadas	Descripción	CAI	S mm	D mm	R' mm	Cdr. mm	Llanta recomendada	Llanta permitida	Cámara de aire (Código)	Volumen interno al 75% (litros)	Profundidad de la banda de rodamiento (mm)
26.5	650/55 R26,5 169D TL	693431	657	1402	617	4158	AG20.00 (H2)		716	437	18
Bar	0.8 0.9 1.0 1.2 1.5 1.8 2.1 2.4 2.7 3.0 3.2 3.4 3.6 3.8 4.0										
Psi	12 13 15 17 22 26 30 35 39 44 46 49 52 55 58										
10 km/h**	3330 3985 4635 5220 6100 6875 7600 8325 8780 9235 9540 9765 9990 10215 10440										
25 km/h	2925 3500 4070 4585 5355 6035 6675 7310 7710 8110 8375 8575 8770 8970 9165										
40 km/h	2515 3010 3500 3945 4610 5195 5745 6290 6635 6980 7210 7380 7550 7720 7890										
50 km/h	2240 2680 3115 3510 4100 4620 5110 5595 5905 6210 6415 6565 6720 6870 7020										
65 km/h	1850 2215 2575 2900 3390 3820 4220 4625 4880 5130 5300 5425 5550 5675 5800										

* Consultar las notas al final de las tablas de esta gama.

MICHELIN® CARGOXBIB HIGH FLOTATION

Características y presiones en (Bar) y (Psi): carga por neumático en kg*

Ø Pulgadas	Descripción	CAI	S mm	D mm	R' mm	Cdr. mm	Llanta recomendada	Llanta permitida	Cámara de aire (Código)	Volumen interno al 75% (litros)	Profundidad de la banda de rodamiento (mm)
26.5	VF 650/55R26.5 IMP 174D TL NUEVO	776393	663	1402	578	4084	AG20.00	AG20.00 (H2)		437	18
Bar	0.8 0.9 1 1.2 1.5 1.8 2.1 2.4 2.7 3 3.2										
Psi	12 13 15 17 22 26 30 35 39 44 46										
10 km/h**	4223 4572 4920 5494 6355 7175 8021 8938 9799 10660 10988										
25 km/h	3760 4070 4380 4891 5658 6388 7140 7957 8724 9490 9782										
40 km/h	3322 3596 3870 4322 4999 5644 6309 7031 7708 8385 8643										
50 km/h	3013 3261 3510 3919 4534 5119 5722 6377 6991 7605 7839										
65 km/h	2575 2770 2965 3350 3875 4325 4830 5450 5975 6500 6700										

Ø Pulgadas	Descripción	CAI	S mm	D mm	R' mm	Cdr. mm	Llanta recomendada	Llanta permitida	Cámara de aire (Código)	Volumen interno al 75% (litros)	Profundidad de la banda de rodamiento (mm)
26.5	VF600/55 R26,5 170D IMP TL	377726	626	1341	587	3959	AG20.00 (H2)			312	17
Bar	0.8 0.9 1.0 1.2 1.5 1.8 2.1 2.4 2.7 3.0 3.2 3.4 3.6 3.8 4.0										
Psi	12 13 15 17 22 26 30 35 39 44 46 49 52 55 58										
10 km/h**	3772 4025 4264 4756 5658 6322 7081 7790 8549 9184 9840										
25 km/h	3358 3583 3796 4234 5037 5628 6304 6935 7610 8176 8760										
40 km/h	2967 3166 3354 3741 4451 4973 5570 6128 6724 7224 7740										
50 km/h	2691 2871 3042 3393 4036 4510 5051 5558 6099 6552 7020										
65 km/h	2300 2450 2600 2900 3450 3855 4280 4750 5275 5600 6000										

Ø Pulgadas	Descripción	CAI	S mm	D mm	R' mm	Cdr. mm	Llanta recomendada	Llanta permitida	Cámara de aire (Código)	Volumen interno al 75% (litros)	Profundidad de la banda de rodamiento (mm)
30.5	750/60 R30.5 181D TL	101332	786	1675	716	4936	AG24.00 (H2)			750	22
Bar	0.8 0.9 1.0 1.2 1.5 1.8 2.1 2.4 2.7 3.0 3.2 3.4 3.6 3.8 4.0										
Psi	12 13 15 17 22 26 30 35 39 44 46 49 52 55 58										
10 km/h**	4770 5750 6730 7490 8625 9765 10900 12040 12565 13095 13445 13795 14150 14500 14850										
25 km/h	4185 4945 5700 6395 7430 8470 9510 10550 11015 11485 11795 12105 12420 12730 13040										
40 km/h	3605 4290 4970 5560 6440 7325 8205 9090 9490 9890 10155 10420 10690 10955 11220										
50 km/h	3205 3810 4410 4935 5720 6505 7295 8080 8435 8795 9030 9270 9505 9745 9980										
65 km/h	2650 3165 3680 4110 4750 5395 6035 6680 6975 7270 7465 7660 7860 8055 8250										

* Consultar las notas al final de las tablas de esta gama.

MICHELIN® CARGOXBIB HIGH FLOTATION

Características y presiones en (Bar) y (Psi): carga por neumático en kg*

Ø Pulgadas	Descripción	CAI	S mm	D mm	R' mm	Cdr. mm	Llanta recomendada	Llanta permitida	Cámara de aire (Código)	Volumen interno al 75% (litros)	Profundidad de la banda de rodamiento (mm)
30.5	VF750/60 R30,5 187D IMP TL	139588	760	1680	724	4944	AG24.00 (H2)			750	22
Bar	0.8 0.9 1.0 1.2 1.5 1.8 2.1 2.4 2.7 3.0 3.2 3.4 3.6 3.8 4.0										
Psi	12 13 15 17 22 26 30 35 39 44 46 49 52 55 58										
10 km/h**	6150 6560 6970 7790 9184 10266 11496 12710 13940 15170 15990										
25 km/h	5475 5840 6205 6935 8176 9140 10235 11315 12410 13505 14235										
40 km/h	4838 5160 5483 6128 7224 8075 9043 9998 10965 11933 12578										
50 km/h	4388 4680 4973 5558 6552 7324 8202 9068 9945 10823 11408										
65 km/h	3750 4000 4250 4750 5600 6260 6965 7750 8500 9250 9750										

Ø Pulgadas	Descripción	CAI	S mm	D mm	R' mm	Cdr. mm	Llanta recomendada	Llanta permitida	Cámara de aire (Código)	Volumen interno al 75% (litros)	Profundidad de la banda de rodamiento (mm)
30.5	650/65 R30.5 176D TL	139310	674	1622	699	4776	AG20.00 (H2)			600	21
Bar	0.8 0.9 1.0 1.2 1.5 1.8 2.1 2.4 2.7 3.0 3.2 3.4 3.6 3.8 4.0										
Psi	12 13 15 17 22 26 30 35 39 44 46 49 52 55 58										
10 km/h**	4140 4970 5800 6450 7430 8405 9385 10360 10815 11270 11570 11875 12175 12480 12780										
25 km/h	3640 4270 4900 5495 6395 7290 8185 9080 9480 9885 10150 10420 10685 10955 11220										
40 km/h	3130 3705 4280 4785 5545 6305 7060 7820 8165 8510 8740 8970 9200 9430 9660										
50 km/h	2780 3285 3790 4245 4920 5600 6280 6960 7265 7570 7775 7980 8185 8385 8590										
65 km/h	2300 2735 3170 3540 4090 4645 5195 5750 6005 6255 6425 6595 6765 6930 7100										

Ø Pulgadas	Descripción	CAI	S mm	D mm	R' mm	Cdr. mm	Llanta recomendada	Llanta permitida	Cámara de aire (Código)	Volumen interno al 75% (litros)	Profundidad de la banda de rodamiento (mm)
32	800/60 R32 185D IMP TL	322432	810	1800	777	5300	DW27B (A)	DW25B (A)	831	900	23.5
Bar	0.8 0.9 1.0 1.2 1.5 1.8 2.1 2.4 2.7 3.0 3.2 3.4 3.6 3.8 4.0										
Psi	12 13 15 17 22 26 30 35 39 44 46 49 52 55 58										
10 km/h**	5400 6525 7650 8580 9975 11205 12355 13500 14345 15190 15750 15975 16200 16425 16650										
25 km/h	4740 5730 6715 7530 8755 9835 10845 11850 12590 13330 13825 14025 14220 14420 14615										
40 km/h	4080 4930 5780 6485 7540 8470 9335 10200 10840 11475 11900 12070 12240 12410 12580										
50 km/h	3630 4390 5145 5770 6710 7535 8305 9075 9645 10210 10590 10740 10895 11045 11195										
65 km/h	3000 3625 4250 4765 5540 6225 6865 7500 7970 8440 8750 8875 9000 9125 9250										

***IMPORTANTE:**

La presión de inflado se determina siempre en función de la carga por neumático, de la velocidad y del trabajo a realizar. Las recomendaciones anteriores se facilitan con la salvedad de modificaciones posteriores a la fecha de difusión de estas tablas (junio de 2018). Los datos técnicos pueden sufrir modificaciones sin previo aviso.

- Para uso en laderas: añadir 0.4 Bar.
- Para uso intensivo en carretera: añadir 0.4 Bar.
- **10 km/h LT (torque bajo) (velocidad máxima 10 km/h).



MICHELIN® CARGOXBIB HEAVY DUTY

**UN VALOR EXCELENTE
PARA TRANSPORTAR
SUS COSECHAS**



Hasta 3 veces más **CAPACIDAD AUTOLIMPIANTE** QUE
GARANTIZA TRACCIÓN EN SUELOS HÚMEDOS



ESTABILIDAD

- Excelente comportamiento en carretera



DURACIÓN

- Resistencia del casco demostrada



DIMENSIONES

560/45 R22.5 152D TL

500/60 R22.5 155D TL

560/60 R22.5 161D TL

MICHELIN® CARGOXBIB HEAVY DUTY

Características y presiones en (Bar) y (Psi): carga por neumático en kg*

Ø Pulgadas	Descripción	CAI	S mm	D mm	R' mm	Cdr. mm	Llanta recomendada	Llanta permitida	Cámara de aire (Código)	Volumen interno al 75% (litros)	Profundidad de la banda de rodamiento (mm)
22.5	560/45 R22.5 152D TL	743789	535	1080	474	3191	AG16.00 (H2)			182	16
Bar	0.8 0.9 1.0 1.2 1.5 1.8 2.1 2.4 2.7 3.0 3.2 3.4 3.6 3.8 4.0										
Psi	12 13 15 17 22 26 30 35 39 44 46 49 52 55 58										
10 km/h**	2070 2225 2375 2665 3095 3475 3845 4245 4650 5050 5320 5585 5855 6120 6390										
25 km/h	1820 1955 2085 2340 2720 3050 3375 3725 4080 4435 4670 4905 5140 5375 5610										
40 km/h	1565 1680 1795 2015 2340 2625 2900 3205 3510 3815 4020 4220 4425 4625 4830										
50 km/h	1390 1495 1600 1795 2085 2340 2585 2855 3125 3400 3580 3760 3940 4120 4300										
65 km/h	1150 1235 1320 1480 1720 1930 2135 2360 2580 2805 2955 3105 3250 3400 3550										

Ø Pulgadas	Descripción	CAI	S mm	D mm	R' mm	Cdr. mm	Llanta recomendada	Llanta permitida	Cámara de aire (Código)	Volumen interno al 75% (litros)	Profundidad de la banda de rodamiento (mm)
22.5	500/60 R22.5 155D TL	441880	505	1172	508	3454	AG16.00 (H2)	14.00 15.00 16.00 17.00		206	16
Bar	0.8 0.9 1.0 1.2 1.5 1.8 2.1 2.4 2.7 3.0 3.2 3.4 3.6 3.8 4.0										
Psi	12 13 15 17 22 26 30 35 39 44 46 49 52 55 58										
10 km/h**	2250 2705 3160 3515 4050 4585 5115 5650 5900 6150 6315 6480 6650 6815 6980										
25 km/h	1975 2330 2680 3005 3495 3985 4470 4960 5180 5395 5540 5685 5830 5975 6120										
40 km/h	1700 2015 2330 2605 3025 3440 3855 4270 4460 4645 4770 4895 5020 5145 5270										
50 km/h	1510 1790 2070 2315 2690 3060 3430 3800 3965 4135 4245 4355 4470 4580 4690										
65 km/h	1250 1490 1730 1930 2235 2535 2840 3140 3280 3420 3510 3605 3695 3790 3880										

Ø Pulgadas	Descripción	CAI	S mm	D mm	R' mm	Cdr. mm	Llanta recomendada	Llanta permitida	Cámara de aire (Código)	Volumen interno al 75% (litros)	Profundidad de la banda de rodamiento (mm)
22.5	560/60 R22.5 161D TL	102433	543	1242	532	3650	AG16.00 (H2)	16.00 17.00 AG20.00 (H2)		269	16
Bar	0.8 0.9 1.0 1.2 1.5 1.8 2.1 2.4 2.7 3.0 3.2 3.4 3.6 3.8 4.0										
Psi	12 13 15 17 22 26 30 35 39 44 46 49 52 55 58										
10 km/h**	2700 3240 3780 4205 4840 5475 6115 6750 7045 7345 7540 7740 7935 8135 8330										
25 km/h	2370 2780 3190 3580 4160 4745 5325 5910 6175 6435 6610 6785 6960 7135 7310										
40 km/h	2040 2415 2790 3120 3610 4105 4595 5090 5315 5540 5690 5840 5990 6140 6290										
50 km/h	1810 2140 2470 2765 3205 3645 4090 4530 4730 4930 5065 5200 5335 5465 5600										
65 km/h	1500 1785 2070 2310 2670 3030 3390 3750 3915 4080 4190 4300 4410 4520 4630										

**10 km/h LT (torque bajo) (velocidad máxima 10 km/h).

* Consultar las notas al final de las tablas de esta gama.



MICHELIN® CARGOXBIB

**MAYOR RESISTENCIA PARA
LAS CARGAS PESADAS A
UNA BAJA PRESIÓN**



RESISTENCIA



PRODUCTIVIDAD



RENTABILIDAD



DIMENSIONES

600/50 R22.5 159D TL
800/45 R26.5 174D TL
710/50 R30.5 173D TL
800/45 R30.5 176D TL
600/60 R30.5 169D TL
850/50 R30.5 182D TL

MICHELIN® CARGOXBIB

Características y presiones en (Bar) y (Psi): carga por neumático en kg*

Ø Pulgadas	Descripción	CAI	S mm	D mm	R' mm	Cdr. mm	Llanta recomendada	Llanta permitida	Cámara de aire (Código)	Volumen interno al 75% (litros)	Profundidad de la banda de rodamiento (mm)
22.5	600/50 R22.5 159D TL	048429	616	1181	510	3478	AG20.00 (H2)			298	17
Bar	1.0 1.3 1.5 1.9 2.2 2.5 2.8 3.1 3.4 3.7 4.0										
Psi	15 19 22 28 32 36 41 45 49 54 58										
10 km/h**	3570 4170 4575 5375 5980 6475 6755 7035 7320 7600 7880										
25 km/h	3020 3570 3940 4670 5225 5675 5920 6170 6415 6665 6910										
40 km/h	2640 3105 3420 4040 4510 4890 5105 5315 5525 5740 5950										
50 km/h	2340 2760 3035 3595 4010 4355 4540 4730 4915 5105 5290										
65 km/h	1950 2290 2520 2970 3315 3595 3750 3910 4065 4225 4380										

Ø Pulgadas	Descripción	CAI	S mm	D mm	R' mm	Cdr. mm	Llanta recomendada	Llanta permitida	Cámara de aire (Código)	Volumen interno al 75% (litros)	Profundidad de la banda de rodamiento (mm)
26.5	800/45 R26.5 174D TL	248959	815	1395	595	4097	AG28.00 (H2)	AG24.00 (H2)		561	19
Bar	1.0 1.3 1.5 1.9 2.2 2.5 2.8 3.1 3.4 3.7 4.0										
Psi	15 19 22 28 32 36 41 45 49 54 58										
10 km/h**	5070 5910 6475 7595 8440 9190 9765 10340 10915 11485 12060										
25 km/h	4230 5015 5535 6585 7365 8060 8565 9070 9580 10085 10590										
40 km/h	3640 4315 4765 5665 6340 6935 7370 7805 8240 8675 9110										
50 km/h	3240 3840 4240 5040 5640 6170 6560 6945 7335 7720 8110										
65 km/h	2680 3175 3505 4165 4660 5095 5420 5740 6060 6380 6700										

Ø Pulgadas	Descripción	CAI	S mm	D mm	R' mm	Cdr. mm	Llanta recomendada	Llanta permitida	Cámara de aire (Código)	Volumen interno al 75% (litros)	Profundidad de la banda de rodamiento (mm)
30.5	710/50 R30.5 173D TL	002786	728	1495	649	4408	AG24.00 (H2)			537	21
Bar	1.0 1.3 1.5 1.9 2.2 2.5 2.8 3.1 3.4 3.7 4.0										
Psi	15 19 22 28 32 36 41 45 49 54 58										
10 km/h**	5310 6205 6800 7990 8885 9620 10035 10450 10870 11285 11700										
25 km/h	4490 5310 5855 6945 7765 8435 8800 9170 9535 9905 10270										
40 km/h	3910 4605 5070 6000 6695 7265 7580 7895 8210 8525 8840										
50 km/h	3470 4090 4505 5335 5955 6465 6745 7025 7310 7590 7870										
65 km/h	2900 3410 3745 4425 4930 5345 5580 5810 6040 6270 6500										

* Consultar las notas al final de las tablas de esta gama.

MICHELIN® CARGOXBIB

Características y presiones en (Bar) y (Psi): carga por neumático en kg*

Ø Pulgadas	Descripción	CAI	S mm	D mm	R' mm	Cdr. mm	Llanta recomendada	Llanta permitida	Cámara de aire (Código)	Volumen interno al 75% (litros)	Profundidad de la banda de rodamiento (mm)
30.5	800/45 R30.5 176D TL	932951	820	1495	650	4408	AG28.00 (H2)			616	21
Bar	1.0 1.3 1.5 1.9 2.2 2.5 2.8 3.1 3.4 3.7 4.0										
Psi	15 19 22 28 32 36 41 45 49 54 58										
10 km/h**	5370 6265 6860 8050 8945 9745 10350 10960 11565 12175 12780										
25 km/h	4490 5320 5870 6980 7805 8540 9075 9610 10150 10685 11220										
40 km/h	3860 4575 5055 6005 6725 7355 7815 8275 8740 9200 9660										
50 km/h	3440 4075 4495 5345 5975 6535 6950 7360 7770 8180 8590										
65 km/h	2840 3365 3715 4415 4940 5405 5745 6080 6420 6760 7100										

Ø Pulgadas	Descripción	CAI	S mm	D mm	R' mm	Cdr. mm	Llanta recomendada	Llanta permitida	Cámara de aire (Código)	Volumen interno al 75% (litros)	Profundidad de la banda de rodamiento (mm)
30.5	600/60 R30.5 169D TL	236518	639	1496	654	4417	AG20.00 (H2)			469	21
Bar	1.0 1.3 1.5 1.9 2.2 2.5 2.8 3.1 3.4 3.7 4.0										
Psi	15 19 22 28 32 36 41 45 49 54 58										
10 km/h**	4730 5530 6060 7130 7925 8585 8955 9325 9700 10070 10440										
25 km/h	4000 4735 5220 6200 6930 7530 7855 8180 8510 8835 9160										
40 km/h	3490 4110 4525 5355 5975 6485 6765 7045 7330 7610 7890										
50 km/h	3100 3655 4020 4760 5310 5765 6015 6265 6520 6770 7020										
65 km/h	2590 3040 3345 3945 4400 4770 4975 5180 5390 5595 5800										

Ø Pulgadas	Descripción	CAI	S mm	D mm	R' mm	Cdr. mm	Llanta recomendada	Llanta permitida	Cámara de aire (Código)	Volumen interno al 75% (litros)	Profundidad de la banda de rodamiento (mm)
30.5	850/50 R30.5 182D TL	938016	861	1628	692	4778	AG28.00 (H2)			817	23
Bar	1.0 1.3 1.5 1.9 2.2 2.5 2.8 3.1 3.4 3.7 4.0										
Psi	15 19 22 28 32 36 41 45 49 54 58										
10 km/h**	6430 7500 8210 9640 10705 11665 12390 13120 13845 14575 15300										
25 km/h	5370 6365 7025 8355 9345 10225 10865 11505 12150 12790 13430										
40 km/h	4620 5475 6050 7190 8050 8805 9355 9905 10460 11010 11560										
50 km/h	4110 4875 5380 6400 7160 7835 8325 8815 9310 9800 10290										
65 km/h	3400 4030 4450 5290 5920 6475 6880 7285 7690 8095 8500										

***IMPORTANTE:**

La presión de inflado se determina siempre en función de la carga por neumático, de la velocidad y del trabajo a realizar. Las recomendaciones anteriores se facilitan con la salvedad de modificaciones posteriores a la fecha de difusión de estas tablas (junio de 2018). Los datos técnicos pueden sufrir modificaciones sin previo aviso.

- Para uso en laderas: añadir 0.4 Bar.
- Para uso intensivo en carretera: añadir 0.4 Bar.
- ** 10 km/h LT (torque bajo) (velocidad máxima 10 km/h).



MICHELIN® CARGOXBIB 2

ALTA CAPACIDAD
DE TRACCIÓN PARA
CARGAS PESADAS



TRACCIÓN de + 28% a + 35%*



PROTECCIÓN DEL SUELO desde 0,6 b



PRODUCTIVIDAD de + 7% a + 11%*



+ 4% INGRESOS **



DIMENSIONES

600/50 R22.5 159D IMPTL

*Dependiendo de la dimensión. Prueba interna realizada en junio y noviembre de 2016, comparando el neumático MICHELIN® VF 650/85 R42 AXIOBIB 2 con un neumático MICHELIN® 650/85 R38 MACHXBIB.

**Estudio realizado por la Universidad Harper Adams 2014/2016, que muestra un rendimiento promedio del 4%, utilizando los neumáticos MICHELIN® UltraFlex en comparación con Neumáticos MICHELIN® estándar de dimensiones similares.

MICHELIN® CARGOXBIB 2

Características y presiones en (Bar) y (Psi): carga por neumático en kg*

Ø Pulgadas	Descripción	CAI	S mm	D mm	R' mm	Cdr. mm	Llanta recomendada	Llanta permitida	Cámara de aire (Código)	Volumen interno al 75% (litros)	Profundidad de la banda de rodamiento (mm)				
22,5	600/50 R22.5 159D IMP TL	740591	616	1181	3478	510	AG20.00 (H2)		TL	298	17				
Bar	0.8	1.0	1.4	1.8	2.2	2.6	2.8	3.0	3.2	3.4	3.6	3.7	3.8	3.9	4.0
Psi	12	15	20	26	32	38	41	44	46	49	52	54	55	57	58
10 km/h**	2 520	3 570	4 375	5 175	5 980	6 570	6 755	6 940	7 130	7 320	7 505	7 600	7 690	7 785	7 880
25 km/h	2 210	3 020	3 755	4 490	5 225	5 755	5 920	6 085	6 250	6 415	6 580	6 660	6 745	6 830	6 910
40 km/h	1 905	2 640	3 265	3 885	4 510	4 960	5 100	5 245	5 385	5 525	5 670	5 740	5 810	5 880	5 880
50 km/h	1 695	2 340	2 895	3 455	4 010	4 415	4 540	4 665	4 790	4 915	5 040	5 100	5 165	5 230	5 290
65 km/h	1 400	1 950	2 405	2 860	3 315	3 645	3 750	3 855	3 960	4 065	4 170	4 220	4 275	4 330	4 380

**10 km/h LT (torque bajo) (velocidad máxima 10 km/h).



**MICHELIN®
XP 27**

**MAYOR RESISTENCIA PARA
LAS CARGAS PESADAS A
UNA BAJA PRESIÓN**



PRODUCTIVIDAD



RENTABILIDAD



DIMENSIONES

270/65 R16 134A8/122A8 TL

270/65 R18 136A8/124A8 TL

340/65 R18 149A8/137A8 TL

MICHELIN® XP 27

Características y presiones en (Bar) y (Psi): carga por neumático en kg*

Ø Pulgadas	Descripción	CAI	S mm	D mm	R' mm	Cdr. mm	Llanta recomendada	Llanta permitida	Cámara de aire (Código)	Volumen interno al 75% (litros)	Profundidad de la banda de rodamiento (mm)
16	270/65 R16 134A8/122A8 TL	184332	265	755	333	2300	W8	W7 W9	827	45	9
Bar	1.0 1.3 1.5 1.9 2.2 2.5 2.8 3.1 3.4 3.7 4.0 4.1 4.4 4.7 5.0										
Psi	15 19 22 28 32 36 41 45 49 54 58 59 64 68 73										
10 km/h**	1060 1235 1350 1580 1755 1930 2105 2280 2450 2625 2800 2815 2870 2920 2970										
25 km/h	895 1045 1145 1340 1490 1640 1785 1935 2085 2230 2380 2395 2440 2480 2525										
30 km/h	840 980 1070 1255 1395 1535 1675 1815 1950 2090 2230 2245 2285 2330 2370										
40 km/h	750 875 960 1125 1250 1375 1500 1625 1750 1875 2000 2010 2050 2085 2120										
50 km/h	690 805 880 1035 1150 1265 1380 1495 1610 1725 1840 1850 1885 1915 1950										

Ø Pulgadas	Descripción	CAI	S mm	D mm	R' mm	Cdr. mm	Llanta recomendada	Llanta permitida	Cámara de aire (Código)	Volumen interno al 75% (litros)	Profundidad de la banda de rodamiento (mm)
18	270/65 R18 136A8/124A8 TL	133069	265	810	361	2472	W8	9 W9	438	51	9
Bar	1.0 1.3 1.5 1.9 2.2 2.5 2.8 3.1 3.4 3.7 4.0 4.1 4.4 4.7 5.0										
Psi	15 19 22 28 32 36 41 45 49 54 58 59 64 68 73										
10 km/h**	1120 1305 1425 1670 1855 2040 2225 2410 2590 2775 2960 2980 3030 3085 3140										
25 km/h	950 1105 1210 1420 1575 1730 1885 2040 2200 2355 2510 2525 2570 2620 2665										
30 km/h	890 1035 1135 1330 1480 1625 1770 1920 2065 2215 2360 2375 2420 2465 2510										
40 km/h	800 930 1020 1195 1325 1455 1585 1715 1850 1980 2110 2125 2160 2200 2240										
50 km/h	730 850 930 1095 1215 1335 1455 1575 1700 1820 1940 1950 1990 2025 2060										

Ø Pulgadas	Descripción	CAI	S mm	D mm	R' mm	Cdr. mm	Llanta recomendada	Llanta permitida	Cámara de aire (Código)	Volumen interno al 75% (litros)	Profundidad de la banda de rodamiento (mm)
18	340/65 R18 149A8/137A8 TL	415969	343	891	393	2720	11	9 W9	828	80	8
Bar	1.0 1.3 1.5 1.9 2.2 2.5 2.8 3.1 3.4 3.7 4.0 4.1 4.4 4.7 5.0										
Psi	15 19 22 28 32 36 41 45 49 54 58 59 64 68 73										
10 km/h**	1620 1885 2065 2420 2685 2950 3215 3480 3750 4015 4280 4305 4390 4470 4550										
25 km/h	1380 1605 1755 2060 2285 2510 2735 2960 3190 3415 3640 3665 3730 3800 3870										
30 km/h	1290 1505 1645 1930 2145 2360 2575 2790 3000 3215 3430 3450 3515 3575 3640										
40 km/h	1160 1350 1475 1730 1920 2110 2300 2490 2680 2870 3060 3080 3135 3195 3250										
50 km/h	1160 1350 1475 1730 1920 2110 2300 2490 2680 2870 3060 3080 3135 3195 3250										

*IMPORTANTE:

La presión de inflado se determina siempre en función de la carga por neumático, de la velocidad y del trabajo a realizar. Las recomendaciones anteriores se facilitan con la salvedad de modificaciones posteriores a la fecha de difusión de estas tablas (junio de 2018). Los datos técnicos pueden sufrir modificaciones sin previo aviso.

Las curvas de carga/presión/velocidad corresponden al uso en rueda libre. Para una rueda motriz, se necesita una reducción del 30%.

- Para uso en laderas: añadir 0.40 Bar.
- Para uso intensivo en carretera: añadir 0.40 Bar.

**10 km/h LT (torque bajo) (velocidad máxima 10 km/h).

XP27: el primer índice de carga hace referencia al uso en rueda libre (uso en maquinaria remolcada); el segundo se refiere al uso en rueda motriz.



MICHELIN® XS

LA REFERENCIA EN
LA INDUSTRIA DE LA
CONSTRUCCIÓN Y LAS
OBRAS PÚBLICAS



RESISTENCIA

- Casco hecho de acero para una mayor resistencia a los impactos con una gran capacidad de carga
- Banda de rodamiento con diseño resistente al daño y tecnología de maquinaria de movimiento de tierras



MOVILIDAD

- Banda de rodamiento amplia y plana que permite una máxima flotación
- Diseñados para el transporte a larga distancia a una velocidad de hasta 80 km/h

SEGURIDAD

- Casco y banda de rodamiento con diseño flexible para conducir a bajas presiones



DIMENSIONES

525/65 R 20.5 TL 173F MI

24 R 20.5 TL 176F MI

MICHELIN® XS

Características y presiones en (Bar) y (Psi): carga por neumático en kg*

Ø Pulgadas	Descripción	CAI	S mm	D mm	R' mm	Cdr. mm	Llanta recomendada	Llanta permitida	Cámara de aire (Código)	Volumen interno al 75% (litros)	Profundidad de la banda de rodamiento (mm)		
20.5	525/65 R 20.5 TL 173F MI	109421	521	1200	549	3640	16		19.5/20.5 UD	253	17		
Bar	1.5	1.8	2.0	2.2	2.4	2.6	2.8	3.0	3.2	3.4	3.6	3.8	4.0
Psi	22	26	29	32	35	38	41	44	46	49	52	55	58
30 km/h	2430	2860	3145	3430	3715	4050	4435	4815	4970	5130	5285	5445	5600
40 km/h	2370	2770	3035	3300	3565	3875	4230	4580	4750	4920	5090	5260	5430
50 km/h	2315	2680	2925	3165	3410	3695	4020	4350	4530	4715	4895	5080	5260
65 km/h				3000	3195	3390	3585	3780	3970	4165	4360	4555	4750
80 km/h					2325	2470	2620	2765	2915	3060	3205	3355	3500

Ø Pulgadas	Descripción	CAI	S mm	D mm	R' mm	Cdr. mm	Llanta recomendada	Llanta permitida	Cámara de aire (Código)	Volumen interno al 75% (litros)	Profundidad de la banda de rodamiento (mm)		
20.5	24 R 20.5 TL 176F MI	109174	602	1374	584	4148	18		20.5 WAMD	404	17		
Bar	1.5	1.8	2.0	2.2	2.4	2.6	2.8	3.0	3.2	3.4	3.6	3.8	4.0
Psi	22	26	29	32	35	38	41	44	46	49	52	55	58
30 km/h	3800	4400	4800	5200	5600	6100	6705	7310	7550	7785	8025	8260	8500
40 km/h	3650	4230	4615	5000	5385	5860	6415	6970	7215	7460	7705	7950	8195
50 km/h	3505	4060	4435	4805	5175	5615	6120	6625	6880	7130	7385	7635	7890
65 km/h				4350	4645	4940	5235	5530	5820	6115	6410	6705	7000
80 km/h					3325	3535	3745	3955	4165	4370	4580	4790	5000

***IMPORTANTE:**

La presión de inflado se determina siempre en función de la carga por neumático, de la velocidad y del trabajo a realizar. Las recomendaciones anteriores se facilitan con la salvedad de modificaciones posteriores a la fecha de difusión de estas tablas (junio de 2018). Los datos técnicos pueden sufrir modificaciones sin previo aviso.

- Para uso en laderas: añadir 0.4 Bar.
- Para uso intensivo en carretera: añadir 0.4 Bar.

MICHELIN COMPACT LINE

DOCUMENTACIÓN TÉCNICA DE NEUMÁTICOS
- 2019/2020



AGRO.MICHELIN.COM

MICHELIN

ÍNDICE

CÓMO LEER LOS DATOS TÉCNICOS	151
GAMAS POR USO	152
EQUIVALENCIAS DIMENSIONALES	153
COMPACT LINE	154
MICHELIN® XMCL	154
MICHELIN® XM 27	160
MICHELIN® BIBLOAD HARD SURFACE	162
MICHELIN® CROSSGRIP	167
MICHELIN® XF	171
MICHELIN® XM 47	173
MICHELIN® BIBSTEEL ALL TERRAIN	176
MICHELIN® BIBSTEEL HARD SURFACE	179
MICHELIN® X TWEEL	181
MICHELIN® POWER CL	182
MICHELIN® POWER DIGGER	188

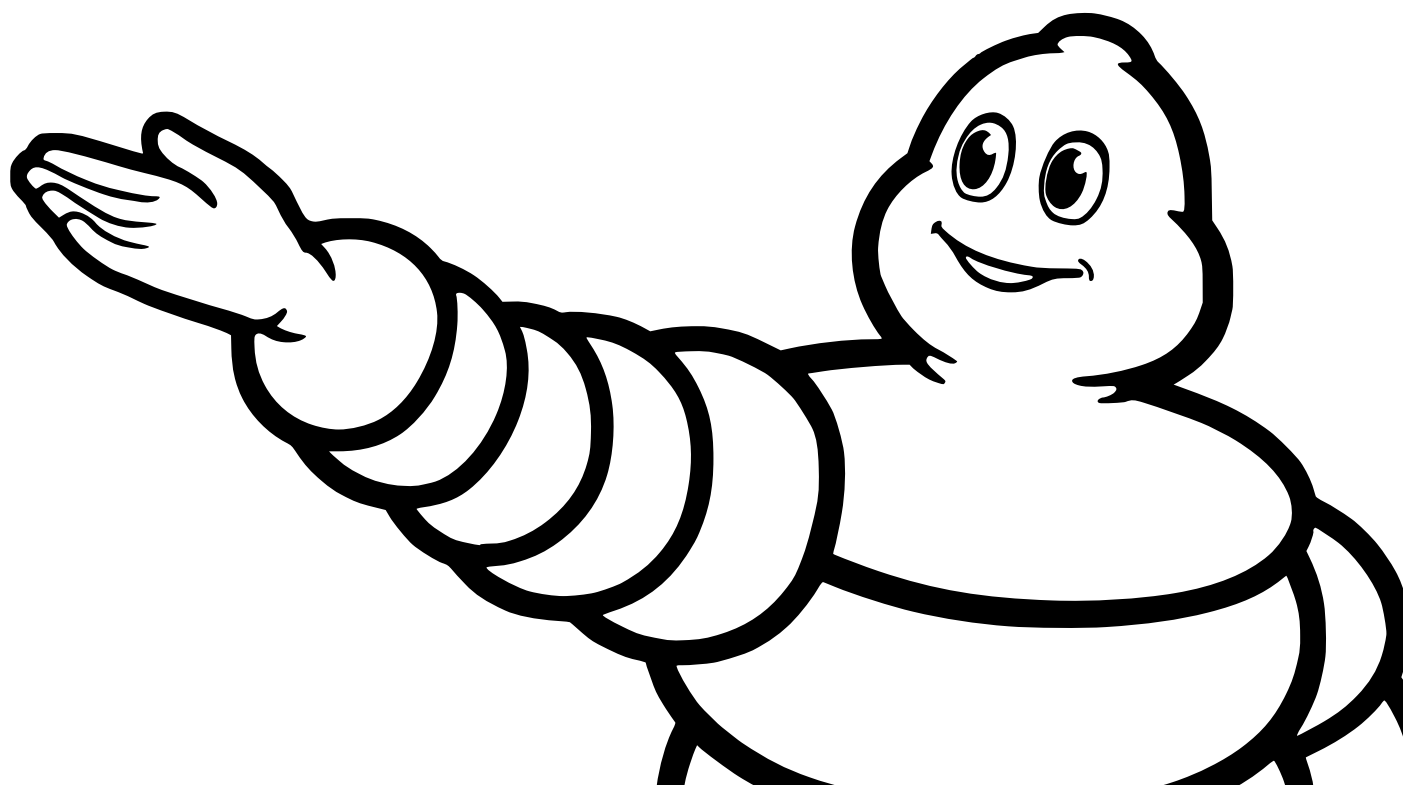

CÓMO LEER LOS DATOS TÉCNICOS

Diámetro de la llanta en pulgadas

País local o Código de artículo internacional

(S) Anchura de sección del neumático en mm

(D) Diámetro exterior en mm

(R') Radio con carga estática en mm

(CdR.) Circunferencia de la banda de rodamiento en mm

Ø Pulgadas	Descripción	CAI	S mm	D mm	R' mm	CdR. mm	Llanta recomendada	Llanta permitida	Cámara de aire (Código)	Volumen interno al 75% (litros)	Profundidad de la banda de rodamiento (mm)
24	500/70 R24 164A8/164B IND TL <i>19.5 LR24 (Equiv 20PR)</i>	296638	536	1460	641	4316	W18L	W16L (NRO)	754	332	48

(IND) Industrial

(TL) Tubeless

Dimensión estándar equivalente

Escala de presión en Bar y Psi

Bar	0.4	0.6	0.8	0.9	1	1.1	1.2	1.3	1.4	1.5	1.6	1.7	1.8	1.9	2
Psi	6	9	12	13	15	16	17	19	20	22	23	25	26	28	29
65 km/h		2180	2500	2690	2875	3065	3250	3405	3565	3720	3875	3970	4065	4155	4250
70 km/h		2000	2295	2470	2640	2815	2985	3130	3270	3415	3555	3640	3730	3815	3900
65 km/h Dual		1920	2180	2310	2440	2570	2700	2830	2960	3090	3220	3350	3480	3610	3740





Velocidad de uso en km/h

Carga por neumático en kg



Al pie de las páginas de datos técnicos de cada gama hay notas importantes acerca del uso de los neumáticos.

GAMAS POR USO

MÁQUINAS/ NEUMÁTICOS	TECNOLOGÍA									
	RADIALES								DIAGONALES	
	XMCL	BIBLOAD HS	CROSSGRIP	BIBSTEEL HS	BIBSTEEL AT	TWEEL HS	TWEEL HS	XF	POWER DIGGER	POWER CL
 Retroexcavadoras	X	X	X							X
 Cargadoras	X	X	X							X
 Teleoscópicas	X	X	X	X	X			X		X
 Excavadoras de ruedas								X	X	
 Minicargadores				X	X	X	X			

EQUIVALENCIAS DIMENSIONALES

EQUIVALENCIAS DIMENSIONALES				COMPACT LINE DE MICHELIN											
Llantas	Pulgadas / Dimensiones	Métrica 1	Métrica 2	XMCL	BIBLOAD HS	CROSSGRIP	XM47	POWER CL	BIBSTEEL HS	BIBSTEEL AT	TWHEEL HS	TWHEEL HS	XF	POWER DIGGER	XM27
15	27x8.5 R 15	210/70 R 15	215/70 R 15							X					
16	7.5 R 16	250/80 R 16				X									
	11 LR 16														X
16,5	10 R 16.5	260/70 R 16.5	265/70 R 16.5						X	X	X	X			
	12 R 16.5	300/70 R 16.5	305/70 R 16.5						X	X	X	X			
17,5	14 R 17.5	360/70 R 17.5								X					
18	10.5/80 R 18	280/80 R 18		X				X							
	12.5/80 R 18	340/80 R 18	335/80 R 18	X	X			X							
		400/70 R 18	405/70 R 18	X	X										
19,5	18 R 19.5	445/70 R 19.5											X		
20	10.5/80 R 20	280/80 R 20	335/80 R 20	X				X							
	12.5/80 R 20	340/80 R 20		X	X			X							
	14.5 R 20	380/75 R 20	375/75 R 20	X											
	16.0/70 R 20	400/70 R 20	405/70 R 20	X	X		X	X							
	16.5/75 R 20	425/75 R 20		X			X								
	10.00 R 20														X
22,5	18 R 22.5	445/70 R 22.5											X		
24	16.0/70 R 24	400/70 R 24		X				X							
	16.9 R 24	440/80 R 24		X	X	X		X							
	17.5 LR 24	460/70 R 24	445/70 R 24	X	X		X	X							
	19.5 LR 24	500/70 R 24	495/70 R 24	X	X		X	X							
	21 LR 24	540/70 R 24		X	X										
	15.5/80 R 24	400/80 R 24				X		X							
26	18.4 R 26	480/80 R 26		X	X			X							
28	16.9 R 28	440/80 R 28		X	X	X		X							
30	16.9 R 30	420/80 R 30						X							



MICHELIN® XMCL

UNA RESISTENCIA
EXCEPCIONAL A LOS CORTES
Y UNA TRACCIÓN EXCELENTE,
INCLUSO EN CONDICIONES
HÚMEDAS Y DIFÍCILES



NEUMÁTICO RADIAL

- Hasta 46% más de duración respecto al neumático diagonal MICHELIN®



TRACCIÓN

- Eficacia sobre superficies blandas



PRODUCTIVIDAD

- Flancos reforzados y lonas superiores de metal para una mayor resistencia a los pinchazos



COMODIDAD

- Mejor manejabilidad



ESTABILIDAD

- Seguridad garantizada



Retroexcavadoras



Cargadoras



Telescópicas

DIMENSIONES

280/80 R18 132A8/132B IND TL

340/80 R18 143A8/143B IND TL

400/70 R18 147A8/147B IND TL

280/80 R20 133A8/133B IND TL

340/80 R20 144A8/144B IND TL

400/70 R20 149A8/149B IND TL

380/75 R20 148A8/148B IND TL

420/75 R20 154A8/154B IND TL

400/70 R24 152A8/152B IND TL

460/70 R24 159A8/159B IND TL

500/70 R24 164A8/164B IND TL

440/80 R24 161A8/161B IND TL

540/70 R24 168A8/168B IND TL

480/80 R26 167A8/167B IND TL

440/80 R28 156A8/156B IND TL

MICHELIN® XMCL

Características y presiones en (Bar) y (Psi): carga por neumático en kg*

Ø Pulgadas	Descripción	CAI	S mm	D mm	R' mm	Cdr. mm	Llanta recomendada	Llanta permitida	Cámara de aire (Código)	Volumen interno al 75% (litros)	Profundidad de la banda de rodamiento (mm)
18	280/80 R18 132A8/132B IND TL <i>10.5 R18 (Equiv 10PR)</i>	779803	290	908	415	2708	W9	W10 W8	438	68	28
Bar	1.6 2.0 2.2 2.4	2.6 2.8 3.0 3.2 3.4 3.6 3.8 4.0	4.2 4.4								
Psi	23 29 32 35	38 41 44 46 49 52 55 58	61 64								
Stat	1800 2200 2400 2600	2800 3000 3200 3400 3600 3800 4000	4200 4400 4600								
10 km/h Cyc	1170 1430 1565 1695	1825 1955 2085 2220 2350 2480 2610	2740 2870 3000								
25 km/h	1060 1255 1350 1445	1540 1635 1735 1830 1930 2025 2125	2220								
30 km/h	1020 1210 1300 1395	1490 1585 1675 1770 1865 1955 2050	2140								
40 km/h	950 1125 1215 1300	1390 1475 1565 1650 1740 1825 1915	2000								
50 km/h	950 1125 1215 1300	1390 1475 1565 1650 1740 1825 1915	2000								

Ø Pulgadas	Descripción	CAI	S mm	D mm	R' mm	Cdr. mm	Llanta recomendada	Llanta permitida	Cámara de aire (Código)	Volumen interno al 75% (litros)	Profundidad de la banda de rodamiento (mm)
18	340/80 R18 143A8/143B IND TL <i>12.5 R18 (Equiv 12PR)</i>	100054	351	996	448	2959	11	11SDC 12 12SDC W10 W11	444 828	107	30
Bar	1.6 2.0 2.2 2.4	2.6 2.8 3.0 3.2 3.4 3.6 3.8 4.0	4.2 4.4								
Psi	23 29 32 35	38 41 44 46 49 52 55 58	61 64								
Stat	2450 2995 3270 3540	3815 4090 4360 4635 4905 5180 5455	5725 6000 6270								
10 km/h Cyc	1600 1955 2135 2310	2490 2670 2845 3025 3200 3380 3555	3735 3915 4090								
25 km/h	1450 1715 1845 1975	2105 2240 2370 2500 2630 2760 2890	3020								
30 km/h	1390 1645 1775 1900	2030 2155 2285 2410 2540 2665 2795	2920								
40 km/h	1320 1550 1665 1780	1895 2010 2125 2240 2360 2485 2605	2725								
50 km/h	1320 1550 1665 1780	1895 2010 2125 2240 2360 2485 2605	2725								

Ø Pulgadas	Descripción	CAI	S mm	D mm	R' mm	Cdr. mm	Llanta recomendada	Llanta permitida	Cámara de aire (Código)	Volumen interno al 75% (litros)	Profundidad de la banda de rodamiento (mm)
18	400/70 R18 147A8/147B IND TL <i>405/70 R18 (Equiv 14PR)</i>	133035	404	1013	454	3008	13			129	30
Bar	1.6 2.0 2.2 2.4	2.6 2.8 3.0 3.2 3.4 3.6 3.8 4.0	4.2 4.4								
Psi	23 29 32 35	38 41 44 46 49 52 55 58	61 64								
Stat	2800 3400 3700 4000	4300 4600 4930 5265 5595 5925 6215 6500	6790 7075								
10 km/h Cyc	1825 2215 2415 2610	2805 3000 3215 3435 3650 3865 4050	4240 4430 4615								
25 km/h	1670 1945 2085 2220	2380 2540 2700 2860 3000 3140 3275	3415								
30 km/h	1605 1875 2005 2140	2295 2450 2600 2755 2890 3025 3155	3290								
40 km/h	1500 1750 1875 2000	2145 2290 2430 2575 2700 2825 2950	3075								
50 km/h	1500 1750 1875 2000	2145 2290 2430 2575 2700 2825 2950	3075								

* Consultar las notas al final de las tablas de esta gama.

MICHELIN® XMCL

Características y presiones en (Bar) y (Psi): carga por neumático en kg*

Ø Pulgadas	Descripción	CAI	S mm	D mm	R' mm	Cdr. mm	Llanta recomendada	Llanta permitida	Cámara de aire (Código)	Volumen interno al 75% (litros)	Profundidad de la banda de rodamiento (mm)
20	280/80 R20 133A8/133B IND TL 10.5 R20 (Equiv 10PR)	747442	292	958	439	2860	W9	W10 W8	542	73	29
Bar	1.6 2.0 2.2 2.4	2.6 2.8 3.0 3.2 3.4 3.6 3.8 4.0	4.2 4.4								
Psi	23 29 32 35	38 41 44 46 49 52 55 58	61 64								
Stat	1850 2260 2470 2675	2880 3085 3290 3500 3705 3910 4120 4325	4535 4740								
10 km/h Cyc	1210 1480 1610 1745	1880 2015 2150 2280 2415 2550 2685 2820	2955 3090								
25 km/h	1090 1290 1390 1490	1590 1690 1790 1890 1990 2090 2190 2290									
30 km/h	1050 1245 1340 1435	1530 1625 1725 1820 1915 2010 2105 2200									
40 km/h	975 1155 1245 1340	1430 1520 1610 1700 1790 1880 1970 2060									
50 km/h	975 1155 1245 1340	1430 1520 1610 1700 1790 1880 1970 2060									

Ø Pulgadas	Descripción	CAI	S mm	D mm	R' mm	Cdr. mm	Llanta recomendada	Llanta permitida	Cámara de aire (Código)	Volumen interno al 75% (litros)	Profundidad de la banda de rodamiento (mm)
20	340/80 R20 144A8/144B IND TL 12.5 R20 (Equiv 12PR)	948730	353	1047	476	3119	11	11SDC 12 12SDC W10 W11	664 444	114	29
Bar	1.6 2.0 2.2 2.4	2.6 2.8 3.0 3.2 3.4 3.6 3.8 4.0	4.2 4.4								
Psi	23 29 32 35	38 41 44 46 49 52 55 58	61 64								
Stat	2520 3080 3360 3640	3920 4200 4480 4760 5040 5320 5600 5880	6160 6440								
10 km/h Cyc	1640 2005 2190 2370	2555 2740 2920 3105 3285 3470 3650 3835	4020 4200								
25 km/h	1490 1760 1895 2030	2165 2300 2435 2570 2705 2840 2975 3110									
30 km/h	1430 1690 1820 1950	2080 2210 2340 2470 2605 2735 2870 3000									
40 km/h	1360 1595 1715 1830	1950 2065 2185 2300 2425 2550 2675 2800									
50 km/h	1360 1595 1715 1830	1950 2065 2185 2300 2425 2550 2675 2800									

Ø Pulgadas	Descripción	CAI	S mm	D mm	R' mm	Cdr. mm	Llanta recomendada	Llanta permitida	Cámara de aire (Código)	Volumen interno al 75% (litros)	Profundidad de la banda de rodamiento (mm)
20	400/70 R20 149A8/149B IND TL 16.0/70 R20 (Equiv 16PR)	474495	412	1069	481	3177	13	12 12SDC 13SDC 14	664	140	33
Bar	1.6 2.0 2.2 2.4	2.6 2.8 3.0 3.2 3.4 3.6 3.8 4.0	4.2 4.4								
Psi	23 29 32 35	38 41 44 46 49 52 55 58	61 64								
Stat	2930 3580 3905 4230	4555 4880 5205 5530 5855 6180 6505 6830	7155 7480								
10 km/h Cyc	1910 2335 2545 2760	2970 3180 3395 3605 3820 4030 4245 4455	4670 4880								
25 km/h	1730 2045 2200 2355	2510 2670 2825 2980 3140 3295 3455 3610									
30 km/h	1660 1965 2115 2265	2415 2570 2720 2870 3025 3175 3330 3480									
40 km/h	1550 1825 1965 2100	2240 2375 2515 2650 2800 2950 3100 3250									
50 km/h	1550 1825 1965 2100	2240 2375 2515 2650 2800 2950 3100 3250									

* Consultar las notas al final de las tablas de esta gama.

MICHELIN® XMCL

Características y presiones en (Bar) y (Psi): carga por neumático en kg*

Ø Pulgadas	Descripción	CAI	S mm	D mm	R' mm	Cdr. mm	Llanta recomendada	Llanta permitida	Cámara de aire (Código)	Volumen interno al 75% (litros)	Profundidad de la banda de rodamiento (mm)
20	380/75 R20 148A8/148B IND TL <i>14.5 R20 (Equiv 12PR)</i>	187752	384	1070	481	3180	W12	11 12 W11	664	136	33
Bar	1.6 2.0 2.2 2.4 2.6 2.8 3.0 3.2 3.4 3.6 3.8 4.0 4.2 4.4										
Psi	23 29 32 35 38 41 44 46 49 52 55 58 61 64										
Stat	2840 3470 3785 4100 4415 4730 5045 5360 5675 5990 6305 6620 6935 7250										
10 km/h Cyc	1850 2260 2465 2670 2875 3080 3285 3490 3695 3900 4110 4315 4525 4730										
25 km/h	1670 1975 2130 2280 2435 2585 2740 2890 3045 3195 3350 3500										
30 km/h	1610 1905 2050 2195 2340 2490 2635 2780 2930 3075 3225 3370										
40 km/h	1500 1770 1905 2040 2170 2305 2440 2575 2720 2865 3005 3150										
50 km/h	1500 1770 1905 2040 2170 2305 2440 2575 2720 2865 3005 3150										

Ø Pulgadas	Descripción	CAI	S mm	D mm	R' mm	Cdr. mm	Llanta recomendada	Llanta permitida	Cámara de aire (Código)	Volumen interno al 75% (litros)	Profundidad de la banda de rodamiento (mm)
20	420/75 R20 154A8/154B IND TL <i>16.5/75 R20 (Equiv 18PR)</i>	967201	428	1138	509	3378	13	12 12SDC 13SDC 14	664	172	33
Bar	1.6 2.0 2.2 2.4 2.6 2.8 3.0 3.2 3.4 3.6 3.8 4.0 4.2 4.4										
Psi	23 29 32 35 38 41 44 46 49 52 55 58 61 64										
Stat	3380 4130 4505 4880 5255 5630 6005 6380 6755 7130 7505 7880 8255 8630										
10 km/h Cyc	2200 2690 2935 3180 3425 3670 3915 4160 4405 4650 4895 5140 5385 5630										
25 km/h	1990 2355 2535 2715 2895 3080 3260 3440 3620 3800 3980 4160										
30 km/h	1920 2270 2440 2615 2790 2965 3135 3310 3485 3660 3835 4010										
40 km/h	1800 2120 2280 2440 2595 2755 2915 3075 3245 3415 3580 3750										
50 km/h	1800 2120 2280 2440 2595 2755 2915 3075 3245 3415 3580 3750										

Ø Pulgadas	Descripción	CAI	S mm	D mm	R' mm	Cdr. mm	Llanta recomendada	Llanta permitida	Cámara de aire (Código)	Volumen interno al 75% (litros)	Profundidad de la banda de rodamiento (mm)
24	400/70 R24 152A8/152B IND TL <i>16.0/70 R24 (Equiv 16PR)</i>	178690	401	1170	531	3485	DW13L	13 13SDC DW12 DW13 DW14L	703	157	33
Bar	1.6 2.0 2.2 2.4 2.6 2.8 3.0 3.2 3.4 3.6 3.8 4.0 4.2 4.4										
Psi	23 29 32 35 38 41 44 46 49 52 55 58 61 64										
Stat	3130 3840 4190 4545 4900 5255 5610 5960 6315 6670 7045 7420 7790 8165										
10 km/h Cyc	2040 2500 2735 2965 3195 3425 3655 3890 4120 4350 4595 4840 5080 5325										
25 km/h	1830 2180 2350 2525 2700 2875 3045 3220 3400 3580 3760 3940										
30 km/h	1765 2100 2270 2435 2605 2770 2940 3105 3280 3455 3625 3800										
40 km/h	1650 1965 2120 2275 2430 2590 2745 2900 3065 3225 3390 3550										
50 km/h	1650 1965 2120 2275 2430 2590 2745 2900 3065 3225 3390 3550										

* Consultar las notas al final de las tablas de esta gama.

MICHELIN® XMCL

Características y presiones en (Bar) y (Psi): carga por neumático en kg*

Ø Pulgadas	Descripción	CAI	S mm	D mm	R' mm	Cdr. mm	Llanta recomendada	Llanta permitida	Cámara de aire (Código)	Volumen interno al 75% (litros)	Profundidad de la banda de rodamiento (mm)
24	460/70 R24 159A8/159B IND TL <i>17.5 LR24 (Equiv 18PR)</i>	244268	467	1248	562	3709	DW15L	14 16 DW14L DW16L TW14L	710	218	36
Bar	1.6 2.0 2.2 2.4 2.6 2.8 3.0 3.2 3.4 3.6 3.8 4.0 4.2 4.4										
Psi	23 29 32 35 38 41 44 46 49 52 55 58 61 64										
Stat	3940 4815 5250 5690 6125 6560 7000 7435 7875 8310 8750 9185 9625 10060										
10 km/h Cyc	2570 3140 3425 3710 3995 4280 4565 4850 5135 5420 5705 5990 6275 6560										
25 km/h	2320 2745 2955 3165 3375 3585 3800 4010 4225 4435 4650 4860										
30 km/h	2240 2650 2850 3055 3260 3460 3665 3870 4075 4275 4480 4680										
40 km/h	2120 2505 2695 2885 3075 3270 3460 3650 3830 4015 4195 4375										
50 km/h	2120 2505 2695 2885 3075 3270 3460 3650 3830 4015 4195 4375										

Ø Pulgadas	Descripción	CAI	S mm	D mm	R' mm	Cdr. mm	Llanta recomendada	Llanta permitida	Cámara de aire (Código)	Volumen interno al 75% (litros)	Profundidad de la banda de rodamiento (mm)
24	500/70 R24 164A8/164B IND TL <i>19.5 LR24 (Equiv 20PR)</i>	542794	511	1302	583	3866	DW16L	16 DW15L	710	266	36
Bar	1.6 2.0 2.2 2.4 2.6 2.8 3.0 3.2 3.4 3.6 3.8 4.0 4.2 4.4										
Psi	23 29 32 35 38 41 44 46 49 52 55 58 61 64										
Stat	4500 5500 6000 6500 7000 7500 8000 8500 9000 9500 10000 10500 11000 11500										
10 km/h Cyc	2930 3585 3910 4240 4565 4890 5220 5545 5875 6200 6525 6850 7175 7500										
25 km/h	2650 3135 3375 3615 3855 4100 4340 4580 4825 5065 5310 5550										
30 km/h	2560 3025 3260 3490 3725 3955 4190 4420 4655 4885 5120 5350										
40 km/h	2360 2800 3020 3245 3465 3685 3905 4125 4345 4565 4780 5000										
50 km/h	2360 2800 3020 3245 3465 3685 3905 4125 4345 4565 4780 5000										

Ø Pulgadas	Descripción	CAI	S mm	D mm	R' mm	Cdr. mm	Llanta recomendada	Llanta permitida	Cámara de aire (Código)	Volumen interno al 75% (litros)	Profundidad de la banda de rodamiento (mm)
24	440/80 R24 161A8/161B IND TL <i>16.9 R24 (Equiv 18PR)</i>	954749	441	1314	592	3907	DW14L	14 DW15L TW14L	710	236	36
Bar	1.6 2.0 2.2 2.4 2.6 2.8 3.0 3.2 3.4 3.6 3.8 4.0 4.2 4.4										
Psi	23 29 32 35 38 41 44 46 49 52 55 58 61 64										
Stat	4160 5085 5550 6010 6475 6940 7400 7865 8325 8790 9255 9715 10180 10640										
10 km/h Cyc	2710 3315 3615 3920 4220 4520 4825 5125 5430 5730 6030 6335 6640 6940										
25 km/h	2460 2905 3130 3350 3575 3795 4020 4240 4465 4685 4910 5130										
30 km/h	2370 2800 3015 3230 3445 3660 3875 4090 4305 4520 4735 4950										
40 km/h	2240 2650 2855 3060 3260 3465 3670 3875 4065 4250 4440 4625										
50 km/h	2240 2650 2855 3060 3260 3465 3670 3875 4065 4250 4440 4625										

* Consultar las notas al final de las tablas de esta gama.

MICHELIN® XMCL

Características y presiones en (Bar) y (Psi): carga por neumático en kg*

Ø Pulgadas	Descripción	CAI	S mm	D mm	R' mm	Cdr. mm	Llanta recomendada	Llanta permitida	Cámara de aire (Código)	Volumen interno al 75% (litros)	Profundidad de la banda de rodamiento (mm)
24	540/70 R24 168A8/168B IND TL 21 LR24 (Equiv 20PR)	959128	562	1356	608	4026	DW18L	DW16L	710	317	38
Bar	1.6 2.0 2.2 2.4 2.6 2.8 3.0 3.2 3.4 3.6 3.8 4.0 4.2 4.4										
Psi	23 29 32 35 38 41 44 46 49 52 55 58 61 64										
Stat	5015 5910 6360 6805 7255 7700 8150 8595 9045 9490 10335 11185 12035 12880										
10 km/h Cyc	3270 3855 4145 4440 4730 5020 5315 5605 5900 6190 6740 7295 7850 8400										
25 km/h	2940 3490 3765 4040 4310 4585 4860 5135 5405 5680 5950 6220										
30 km/h	2840 3370 3630 3895 4160 4425 4685 4950 5215 5475 5740 6000										
40 km/h	2650 3145 3390 3640 3885 4130 4380 4625 4870 5115 5355 5600										
50 km/h	2650 3145 3390 3640 3885 4130 4380 4625 4870 5115 5355 5600										

Ø Pulgadas	Descripción	CAI	S mm	D mm	R' mm	Cdr. mm	Llanta recomendada	Llanta permitida	Cámara de aire (Código)	Volumen interno al 75% (litros)	Profundidad de la banda de rodamiento (mm)
26	480/80 R26 167A8/167B IND TL 18.4 R26 (Equiv 20PR)	425979	495	1422	636	4218	DW15L	DW16L	716	302	36
Bar	1.6 2.0 2.2 2.4 2.6 2.8 3.0 3.2 3.4 3.6 3.8 4.0 4.2 4.4										
Psi	23 29 32 35 38 41 44 46 49 52 55 58 61 64										
Stat	4900 5990 6535 7080 7625 8170 8715 9260 9805 10350 10895 11445 11990 12535										
10 km/h Cyc	3200 3910 4265 4620 4975 5330 5685 6040 6395 6750 7460 8175										
25 km/h	2890 3420 3680 3945 4210 4475 4735 5000 5265 5525 5790 6050										
30 km/h	2790 3300 3550 3805 4060 4315 4565 4820 5075 5330 5580 5835										
40 km/h	2575 3055 3295 3540 3780 4020 4260 4500 4740 4975 5215 5450										
50 km/h	2575 3055 3295 3540 3780 4020 4260 4500 4740 4975 5215 5450										

Ø Pulgadas	Descripción	CAI	S mm	D mm	R' mm	Cdr. mm	Llanta recomendada	Llanta permitida	Cámara de aire (Código)	Volumen interno al 75% (litros)	Profundidad de la banda de rodamiento (mm)
28	440/80 R28 156A8/156B IND TL 16.9 R28 (Equiv 18PR)	316223	459	1410	641	4200	DW14L	DW15L	822	260	36
Bar	1.6 2.0 2.2 2.4 2.6 2.8 3.0 3.2 3.4 3.6 3.8 4.0 4.2 4.4										
Psi	23 29 32 35 38 41 44 46 49 52 55 58 61 64										
Stat	4360 5330 5810 6295 6780 7265 7750 8230 8715 9200										
10 km/h Cyc	2840 3470 3790 4105 4420 4735 5050 5370 5685 6000										
25 km/h	2570 3040 3270 3505 3740 3970 4205 4440										
30 km/h	2480 2930 3155 3380 3605 3830 4055 4280										
40 km/h	2300 2725 2940 3150 3365 3575 3790 4000										
50 km/h	2300 2725 2940 3150 3365 3575 3790 4000										

***IMPORTANTE:**

La presión de inflado se determina siempre en función de la carga por neumático, de la velocidad y del trabajo a realizar. Las recomendaciones anteriores se facilitan con la salvedad de modificaciones posteriores a la fecha de difusión de estas tablas (junio de 2018). Los datos técnicos pueden sufrir modificaciones sin previo aviso.

- Para uso en laderas: añadir 0.4 Bar.
- Para uso intensivo en carretera: añadir 0.4 Bar.
- Stat: carga estática.
- 10 km/h Cyc: velocidad máxima 10 km/h con carga cíclica.



MICHELIN® XM 27

UNA RESISTENCIA EXCEPCIONAL ANTE LAS AGRESIONES Y UNA TRACCIÓN EXCELENTE, INCLUSO EN CONDICIONES HÚMEDAS Y DIFÍCILES



NEUMÁTICO RADIAL

- Hasta 46% más de duración respecto al neumático diagonal MICHELIN®



TRACCIÓN

- Eficacia sobre superficies blandas



PRODUCTIVIDAD

- Flancos reforzados y lonas superiores de metal para una mayor resistencia a los pinchazos



COMODIDAD

- Mejor manejabilidad



ESTABILIDAD

- Seguridad garantizada



Retroexcavadoras



Cargadoras

DIMENSIONES

11 LR16 122A8 IND TL

MICHELIN® XM 27

Características y presiones en (Bar) y (Psi): carga por neumático en kg*

Ø Pulgadas	Descripción	CAI	S mm	D mm	R' mm	Cdr. mm	Llanta recomendada	Llanta permitida	Cámara de aire (Código)	Volumen interno al 75% (litros)	Profundidad de la banda de rodamiento (mm)
16	11 LR16 122A8 IND TL	123207	291	850	375	2515	W8	W10L	184	60	23
Bar	1,20 1,60 2,00 2,20 2,40 2,60										
Psi	17 23 29 32 35 38										
10 km/h**	1265 1530 1790 1920 2055 2185										
30 km/h	940 1165 1385 1500 1610										
40 km/h	880 1085 1295 1395 1500										

***IMPORTANTE:**

La presión de inflado se determina siempre en función de la carga por neumático, de la velocidad y del trabajo a realizar. Las recomendaciones anteriores se facilitan con la salvedad de modificaciones posteriores a la fecha de difusión de estas tablas (junio de 2018). Los datos técnicos pueden sufrir modificaciones sin previo aviso.

- Para uso en laderas: añadir 0.4 Bar.
- Para uso intensivo en carretera: añadir 0.4 Bar.
- Stat: carga estática.
- 10 km/h Cyc: velocidad máxima 10 km/h con carga cíclica.
- **10 km/h LT (bajo torque) (velocidad máxima 10 km/h).



MICHELIN® BIBLOAD HARD SURFACE

**MAYOR DURABILIDAD
Y MEJOR CALIDAD DE
MANEJO**



NEUMÁTICO RADIAL



TRACCIÓN

- +30% de huella con el suelo respecto al XMCL



PRODUCTIVIDAD

- Lonas superiores de metal para una mayor resistencia a los pinchazos



COMODIDAD

- Excelente estabilidad en pendientes y la misma COMODIDAD de calidad que el XMCL



Retroexcavadoras



Cargadoras



Telescópicas

DIMENSIONES

340/80 R18 143A8/143B IND TL
400/70 R18 147A8/147B IND TL
340/80 R20 144A8/144B IND TL
400/70 R20 149A8/149B IND TL
460/70 R24 159A8/159B IND TL
440/80 R24 161A8/161B IND TL

500/70 R24 164A8/164B IND TL
540/70 R24 168A8/168B IND TL
480/80 R26 167A8/167B IND TL
440/80 R28 163A8/163B IND TL

MICHELIN® BIBLOAD HARD SURFACE

Características y presiones en (Bar) y (Psi): carga por neumático en kg*

Ø Pulgadas	Descripción	CAI	S mm	D mm	R' mm	Cdr. mm	Llanta recomendada	Llanta permitida	Cámara de aire (Código)	Volumen interno al 75% (litros)	Profundidad de la banda de rodamiento (mm)
18	340/80 R18 143A8/143B IND TL <i>12.5 R18 (Equiv 12PR)</i>	415829	342	990	448	2946	11	11SDC 12 12SDC W10 W11	828 444	107	28
Bar	1.6 1.8 2.0 2.2 2.4 2.6 2.8 3.0 3.2 3.4 3.6 3.8 4.0 4.2 4.4										
Psi	23 26 29 32 35 38 41 44 46 49 52 55 58 61 64										
Stat	2450 2725 2995 3270 3540 3815 4090 4360 4635 4905 5180 5455 5725 6000 6270										
10 km/h Cyc	1600 1780 1955 2135 2310 2490 2670 2845 3025 3200 3380 3555 3735 3915 4090										
25 km/h	1450 1580 1715 1845 1975 2105 2240 2370 2500 2630 2760 2890 3020										
30 km/h	1390 1520 1645 1775 1900 2030 2155 2285 2410 2540 2665 2795 2920										
40 km/h	1320 1435 1550 1665 1780 1895 2010 2125 2240 2360 2485 2605 2725										
50 km/h	1320 1435 1550 1665 1780 1895 2010 2125 2240 2360 2485 2605 2725										

Ø Pulgadas	Descripción	CAI	S mm	D mm	R' mm	Cdr. mm	Llanta recomendada	Llanta permitida	Cámara de aire (Código)	Volumen interno al 75% (litros)	Profundidad de la banda de rodamiento (mm)
18	400/70 R18 147A8/147B IND TL <i>40S/70 R18 (Equiv 14PR)</i>	239365	397	1006	448	2983	13	12 12SDC 13.00		129	29
Bar	1.6 1.8 2.0 2.2 2.4 2.6 2.8 3.0 3.2 3.4 3.6 3.8 4.0 4.2 4.4										
Psi	23 26 29 32 35 38 41 44 46 49 52 55 58 61 64										
Stat	2800 3100 3400 3700 4000 4300 4600 4930 5265 5595 5925 6215 6500 6790 7075										
10 km/h Cyc	1825 2020 2215 2415 2610 2805 3000 3215 3435 3650 3865 4050 4240 4430 4615										
25 km/h	1670 1810 1945 2085 2220 2380 2540 2700 2860 3000 3140 3275 3415										
30 km/h	1605 1740 1875 2005 2140 2295 2450 2600 2755 2890 3025 3155 3290										
40 km/h	1500 1625 1750 1875 2000 2145 2290 2430 2575 2700 2825 2950 3075										
50 km/h	1500 1625 1750 1875 2000 2145 2290 2430 2575 2700 2825 2950 3075										

Ø Pulgadas	Descripción	CAI	S mm	D mm	R' mm	Cdr. mm	Llanta recomendada	Llanta permitida	Cámara de aire (Código)	Volumen interno al 75% (litros)	Profundidad de la banda de rodamiento (mm)
20	340/80 R20 144A8/144B IND TL <i>12.5 R20 (Equiv 12PR)</i>	991253	346	1041	473	3100	11	11SDC 12 12SDC W10 W11	664 444	114	28
Bar	1.6 1.8 2.0 2.2 2.4 2.6 2.8 3.0 3.2 3.4 3.6 3.8 4.0 4.2 4.4										
Psi	23 26 29 32 35 38 41 44 46 49 52 55 58 61 64										
Stat	2520 2800 3080 3360 3640 3920 4200 4480 4760 5040 5320 5600 5880 6160 6440										
10 km/h Cyc	1640 1825 2005 2190 2370 2555 2740 2920 3105 3285 3470 3650 3835 4020 4200										
25 km/h	1490 1625 1760 1895 2030 2165 2300 2435 2570 2705 2840 2975 3110										
30 km/h	1430 1560 1690 1820 1950 2080 2210 2340 2470 2605 2735 2870 3000										
40 km/h	1360 1480 1595 1715 1830 1950 2065 2185 2300 2425 2550 2675 2800										
50 km/h	1360 1480 1595 1715 1830 1950 2065 2185 2300 2425 2550 2675 2800										

* Consultar las notas al final de las tablas de esta gama.

MICHELIN® BIBLOAD HARD SURFACE

Características y presiones en (Bar) y (Psi): carga por neumático en kg*

Ø Pulgadas	Descripción	CAI	S mm	D mm	R' mm	Cdr. mm	Llanta recomendada	Llanta permitida	Cámara de aire (Código)	Volumen interno al 75% (litros)	Profundidad de la banda de rodamiento (mm)
20	400/70 R20 149A8/149B IND TL <i>16.0/70 R20 (Equiv 16PR)</i>	793611	403	1068	480	3174	13	12 12SDC 13SDC 14	664	140	29
Bar	1.6 1.8 2.0 2.2 2.4 2.6 2.8 3.0 3.2 3.4 3.6 3.8 4.0 4.2 4.4										
Psi	23 26 29 32 35 38 41 44 46 49 52 55 58 61 64										
Stat	2930 3255 3580 3905 4230 4555 4880 5205 5530 5855 6180 6505 6830 7155 7480										
10 km/h Cyc	1910 2120 2335 2545 2760 2970 3180 3395 3605 3820 4030 4245 4455 4670 4880										
25 km/h	1730 1885 2045 2200 2355 2510 2670 2825 2980 3140 3295 3455 3610										
30 km/h	1660 1810 1965 2115 2265 2415 2570 2720 2870 3025 3175 3330 3480										
40 km/h	1550 1690 1825 1965 2100 2240 2375 2515 2650 2800 2950 3100 3250										
50 km/h	1550 1690 1825 1965 2100 2240 2375 2515 2650 2800 2950 3100 3250										

Ø Pulgadas	Descripción	CAI	S mm	D mm	R' mm	Cdr. mm	Llanta recomendada	Llanta permitida	Cámara de aire (Código)	Volumen interno al 75% (litros)	Profundidad de la banda de rodamiento (mm)
24	460/70 R24 159A8/159B IND TL <i>17.5 LR24 (Equiv 18PR)</i>	372690	467	1241	558	3688	DW15L	14 16 DW14L DW16L	710	218	33
Bar	1.6 1.8 2.0 2.2 2.4 2.6 2.8 3.0 3.2 3.4 3.6 3.8 4.0 4.2 4.4										
Psi	23 26 29 32 35 38 41 44 46 49 52 55 58 61 64										
Stat	3940 4375 4815 5250 5690 6125 6560 7000 7435 7875 8310 8750 9185 9625 10060										
10 km/h Cyc	2570 2855 3140 3425 3710 3995 4280 4565 4850 5135 5420 5705 5990 6275 6560										
25 km/h	2320 2530 2745 2955 3165 3375 3585 3800 4010 4225 4435 4650 4860										
30 km/h	2240 2445 2650 2850 3055 3260 3460 3665 3870 4075 4275 4480 4680										
40 km/h	2120 2310 2505 2695 2885 3075 3270 3460 3650 3830 4015 4195 4375										
50 km/h	2120 2310 2505 2695 2885 3075 3270 3460 3650 3830 4015 4195 4375										

Ø Pulgadas	Descripción	CAI	S mm	D mm	R' mm	Cdr. mm	Llanta recomendada	Llanta permitida	Cámara de aire (Código)	Volumen interno al 75% (litros)	Profundidad de la banda de rodamiento (mm)
24	440/80 R24 161A8/161B IND TL <i>16.9 R24 (Equiv 18PR)</i>	814805	448	1299	584	3860	DW14L	14 DW15L	710	234	32
Bar	1.6 1.8 2.0 2.2 2.4 2.6 2.8 3.0 3.2 3.4 3.6 3.8 4.0 4.2 4.4										
Psi	23 26 29 32 35 38 41 44 46 49 52 55 58 61 64										
Stat	4255 4720 5185 5650 6115 6585 7050 7515 7980 8445 8910 9345 9775 10210 10640										
10 km/h Cyc	2775 3080 3380 3685 3990 4295 4595 4900 5205 5505 5810 6095 6375 6660 6940										
25 km/h	2500 2720 2935 3155 3370 3590 3805 4025 4240 4475 4705 4940 5170										
30 km/h	2390 2630 2865 3105 3340 3580 3815 4055 4290 4485 4680 4875 5070										
40 km/h	2180 2375 2575 2770 2965 3160 3355 3555 3750 3970 4190 4405 4625										
50 km/h	2180 2375 2575 2770 2965 3160 3355 3555 3750 3970 4190 4405 4625										

* Consultar las notas al final de las tablas de esta gama.

MICHELIN® BIBLOAD HARD SURFACE

Características y presiones en (Bar) y (Psi): carga por neumático en kg*

Ø Pulgadas	Descripción	CAI	S mm	D mm	R' mm	Cdr. mm	Llanta recomendada	Llanta permitida	Cámara de aire (Código)	Volumen interno al 75% (litros)	Profundidad de la banda de rodamiento (mm)
24	500/70 R24 164A8/164B IND TL 19.5 LR24 (Equiv 20PR)	346709	499	1299	594	3874	DW16L	16 DW15L	710	266	32
Bar	1.6 1.8 2.0 2.2 2.4 2.6 2.8 3.0 3.2 3.4 3.6 3.8 4.0 4.2 4.4										
Psi	23 26 29 32 35 38 41 44 46 49 52 55 58 61 64										
Stat	4500 5000 5500 6000 6500 7000 7500 8000 8500 9000 9500 10000 10500 11000 11500										
10 km/h Cyc	2930 3255 3585 3910 4240 4565 4890 5220 5545 5875 6200 6525 6850 7175 7500										
25 km/h	2650 2890 3135 3375 3615 3855 4100 4340 4580 4825 5065 5310 5550										
30 km/h	2560 2795 3025 3260 3490 3725 3955 4190 4420 4655 4885 5120 5350										
40 km/h	2360 2580 2800 3020 3245 3465 3685 3905 4125 4345 4565 4780 5000										
50 km/h	2360 2580 2800 3020 3245 3465 3685 3905 4125 4345 4565 4780 5000										

Ø Pulgadas	Descripción	CAI	S mm	D mm	R' mm	Cdr. mm	Llanta recomendada	Llanta permitida	Cámara de aire (Código)	Volumen interno al 75% (litros)	Profundidad de la banda de rodamiento (mm)
24	540/70 R24 168A8/168B IND TL 21 LR24 (Equiv 20PR)	005412	567	1341	600	3981	DW18L	DW16L	710	317	33
Bar	1.6 1.8 2.0 2.2 2.4 2.6 2.8 3.0 3.2 3.4 3.6 3.8 4.0 4.2 4.4										
Psi	23 26 29 32 35 38 41 44 46 49 52 55 58 61 64										
Stat	5015 5465 5910 6360 6805 7255 7700 8150 8595 9045 9490 10335 11185 12035 12880										
10 km/h Cyc	3270 3560 3855 4145 4440 4730 5020 5315 5605 5900 6190 6740 7295 7850 8400										
25 km/h	2940 3215 3490 3765 4040 4310 4585 4860 5135 5405 5680 5950 6220										
30 km/h	2840 3105 3370 3630 3895 4160 4425 4685 4950 5215 5475 5740 6000										
40 km/h	2650 2895 3145 3390 3640 3885 4130 4380 4625 4870 5115 5355 5600										
50 km/h	2650 2895 3145 3390 3640 3885 4130 4380 4625 4870 5115 5355 5600										

Ø Pulgadas	Descripción	CAI	S mm	D mm	R' mm	Cdr. mm	Llanta recomendada	Llanta permitida	Cámara de aire (Código)	Volumen interno al 75% (litros)	Profundidad de la banda de rodamiento (mm)
26	480/80 R26 167A8/167B IND TL 18.4 R26 (Equiv 20PR)	886709	509	1419	637	4215	DW15L	DW16L	716	304	33
Bar	1.6 1.8 2.0 2.2 2.4 2.6 2.8 3.0 3.2 3.4 3.6 3.8 4.0 4.2 4.4										
Psi	23 26 29 32 35 38 41 44 46 49 52 55 58 61 64										
Stat	4900 5445 5990 6535 7080 7625 8170 8715 9260 9805 10350 10895 11445 11990 12535										
10 km/h Cyc	3200 3555 3910 4265 4620 4975 5330 5685 6040 6395 6750 7460 8175										
25 km/h	2890 3155 3420 3680 3945 4210 4475 4735 5000 5265 5525 5790 6050										
30 km/h	2790 3045 3300 3550 3805 4060 4315 4565 4820 5075 5330 5580 5835										
40 km/h	2575 2815 3055 3295 3540 3780 4020 4260 4500 4740 4975 5215 5450										
50 km/h	2575 2815 3055 3295 3540 3780 4020 4260 4500 4740 4975 5215 5450										

* Consultar las notas al final de las tablas de esta gama.

MICHELIN® BIBLOAD HARD SURFACE

Características y presiones en (Bar) y (Psi): carga por neumático en kg*

Ø Pulgadas	Descripción	CAI	S mm	D mm	R' mm	Cdr. mm	Llanta recomendada	Llanta permitida	Cámara de aire (Código)	Volumen interno al 75% (litros)	Profundidad de la banda de rodamiento (mm)				
28	440/80 R28 163A8/163B IND TL <i>16.9 R28 (Equiv 18PR)</i>	195802	446	1407	637	4188	DW14L	DW15L	822	259	33				
Bar	1.6	1.8	2.0	2.2	2.4	2.6	2.8	3.0	3.2	3.4	3.6	3.8	4.0	4.2	4.4
Psi	23	26	29	32	35	38	41	44	46	49	52	55	58	61	64
Stat	4370	4930	5485	6045	6605	7165	7720	8280	8840	9395	9955	10515	11075	11630	12190
10 km/h Cyc	2850	3275	3700	4125	4550	4975	5400	5825	6250	6675	7100	7525	7950		
25 km/h	2620	2855	3085	3320	3550	3785	4015	4250	4480	4715	4945	5180	5410		
30 km/h	2525	2750	2975	3200	3420	3645	3870	4095	4320	4545	4765	4990	5215		
40 km/h	2360	2570	2780	2990	3200	3410	3620	3825	4035	4245	4455	4665	4875		
50 km/h	2360	2570	2780	2990	3200	3410	3620	3825	4035	4245	4455	4665	4875		

***IMPORTANTE:**

La presión de inflado se determina siempre en función de la carga por neumático, de la velocidad y del trabajo a realizar. Las recomendaciones anteriores se facilitan con la salvedad de modificaciones posteriores a la fecha de difusión de estas tablas (junio de 2018). Los datos técnicos pueden sufrir modificaciones sin previo aviso.

- Para uso en laderas: añadir 0.4 Bar.
- Para uso intensivo en carretera: añadir 0.4 Bar.
- Stat: carga estática.
- 10 km/h Cyc: velocidad máxima 10 km/h con carga cíclica.

NUEVO



MICHELIN® CROSSGRIP

**UN NEUMÁTICO VERSÁTIL
PARA CONDUCIR EN LA
CARRETERA, EN EL PASTO
O EN LA NIEVE**



VERSATILIDAD

- Puede utilizarse todo el año



PRODUCTIVIDAD

- Mayor carga a 65 km/h⁽¹⁾
- Excelente resistencia a los pinchazos



TRACCIÓN

- Borde extra largo con banda de rodamiento optimizada para buena tracción en nieve (M+S)



Retroexcavadoras



Cargadoras



Tractores



Telescópicas

(1) En el caso de la dimensión 440/80 R28 163A8/158D IND TL, el neumático MICHELIN® 158D puede cargar 4,250 kg a 65 km/h, mientras que los neumáticos 151D de la competencia cargan 3,450 kg a 65 km/h. Fuente: norma ETRTO.

DIMENSIONES

250/80 R16 124A8/120D IND TL

400/80 R24 156A8/151D IND TL

460/70 R24 159A8/154D IND TL **NUEVO**

440/80 R24 161A8/156D IND TL **NUEVO**

400/80 R28 158A8/153D IND TL **NUEVO**

440/80 R28 163A8/158D IND TL **NUEVO**

480/80 R38 166A8/161D IND TL **NUEVO**

MICHELIN® CROSSGRIP

Características y presiones en (Bar) y (Psi): carga por neumático en kg*

Ø Pulgadas	Descripción	CAI	S mm	D mm	R' mm	Cdr. mm	Llanta recomendada	Llanta permitida	Cámara de aire (Código)	Volumen interno al 75% (litros)	Profundidad de la banda de rodamiento (mm)
16	250/80 R16 124A8/120D IND TL	564847	259	804	364	2402	W8	W7 W9	184	48	17
Bar	1.6 1.8 2.0 2.2 2.4 2.6 2.8 3.0 3.2 3.4 3.6 3.8 4.0 4.2 4.4										
Psi	23 26 29 32 35 38 41 44 46 49 52 55 58 61 64										
Stat	1450 1610 1765 1925 2085 2245 2400 2560 2720 2875 3035 3195 3360 3520 3680										
10 km/h Cyc	945 1050 1150 1255 1360 1465 1565 1670 1775 1875 1980 2085 2190 2295 2400										
25 km/h	850 915 980 1045 1110 1175 1240 1305 1370 1465 1560 1655 1750										
30 km/h	820 885 950 1015 1080 1145 1210 1275 1340 1435 1530 1620 1715										
40 km/h	780 840 905 965 1025 1085 1150 1210 1270 1355 1435 1520 1600										
50 km/h	780 840 905 965 1025 1085 1150 1210 1270 1355 1435 1520 1600										
65 km/h	655 720 780 845 905 970 1030 1095 1155 1215 1280 1340 1400										

Ø Pulgadas	Descripción	CAI	S mm	D mm	R' mm	Cdr. mm	Llanta recomendada	Llanta permitida	Cámara de aire (Código)	Volumen interno al 75% (litros)	Profundidad de la banda de rodamiento (mm)
24	400/80 R24 156A8/151D IND TL <i>15.5/80 R24 (Equiv 20PR)</i>	920345	413	1240	567	3747	DW13L	DW12 DW14L	703	187	26
Bar	1.6 1.8 2.0 2.2 2.4 2.6 2.8 3.0 3.2 3.4 3.6 3.8 4.0 4.2 4.4										
Psi	23 26 29 32 35 38 41 44 46 49 52 55 58 61 64										
Stat	3600 4000 4400 4800 5200 5600 6000 6400 6800 7200 7600 8000 8400 8800 9200										
10 km/h Cyc	2340 2600 2860 3125 3385 3645 3905 4165 4430 4690 4950 5215 5475 5740 6000										
25 km/h	2120 2285 2450 2610 2775 2940 3100 3265 3430 3665 3905 4140 4375										
30 km/h	2060 2225 2385 2550 2710 2875 3035 3200 3360 3590 3825 4055 4290										
40 km/h	1950 2105 2255 2410 2565 2715 2870 3020 3175 3380 3590 3795 4000										
50 km/h	1950 2105 2255 2410 2565 2715 2870 3020 3175 3380 3590 3795 4000										
65 km/h	1640 1785 1930 2075 2225 2370 2515 2660 2805 2965 3130 3290 3450										

Ø Pulgadas	Descripción	CAI	S mm	D mm	R' mm	Cdr. mm	Llanta recomendada	Llanta permitida	Cámara de aire (Código)	Volumen interno al 75% (litros)	Profundidad de la banda de rodamiento (mm)
24	460/70 R24 159A8/154D IND TL NUEVO	304047	475	1246	573	3772	DW15L	14 16 DW14L DW16A		217	26
Bar	1.6 1.8 2.0 2.2 2.4 2.6 2.8 3.0 3.2 3.4 3.6 3.8 4.0 4.2 4.4										
Psi	23 26 29 32 35 38 41 44 46 49 52 55 58 61 64										
Stat	3940 4375 4815 5250 5690 6125 6560 7000 7435 7875 8310 8750 9185 9625 10060										
10 km/h Cyc	2570 2855 3140 3425 3710 3995 4280 4565 4850 5135 5420 5705 5990 6275 6560										
25 km/h	2320 2530 2745 2955 3165 3375 3585 3800 4010 4225 4435 4650 4860										
30 km/h	2240 2445 2650 2850 3055 3260 3460 3665 3870 4075 4275 4480 4680										
40 km/h	2120 2310 2505 2695 2885 3075 3270 3460 3650 3830 4015 4195 4375										
50 km/h	2120 2310 2505 2695 2885 3075 3270 3460 3650 3830 4015 4195 4375										
65 km/h	1820 1985 2150 2310 2475 2640 2800 2965 3130 3285 3440 3595 3750										

* Consultar las notas al final de las tablas de esta gama.

MICHELIN® CROSSGRIP

Características y presiones en (Bar) y (Psi): carga por neumático en kg*

Ø Pulgadas	Descripción	CAI	S mm	D mm	R' mm	Cdr. mm	Llanta recomendada	Llanta permitida	Cámara de aire (Código)	Volumen interno al 75% (litros)	Profundidad de la banda de rodamiento (mm)
24	440/80 R24 161A8/156D IND	131846	447	1314	593	3977	DW14L	DW15L	710	234	26
	TL NUEVO										
	16.9 R24 (Equiv 18PR)										
Bar	1.6 1.8 2.0 2.2 2.4 2.6 2.8 3.0 3.2 3.4 3.6 3.8 4.0 4.2 4.4										
Psi	23 26 29 32 35 38 41 44 46 49 52 55 58 61 64										
Stat	4160 4625 5085 5550 6010 6475 6940 7400 7865 8325 8790 9255 9715 10180 10640										
10 km/h Cyc	2710 3010 3315 3615 3920 4220 4525 4825 5125 5430 5730 6035 6335 6640 6940										
25 km/h	2460 2685 2905 3130 3350 3575 3795 4020 4240 4465 4685 4910 5130										
30 km/h	2370 2585 2800 3015 3230 3445 3660 3875 4090 4305 4520 4735 4950										
40 km/h	2240 2445 2650 2855 3060 3260 3465 3670 3875 4065 4250 4440 4625										
50 km/h	2240 2445 2650 2855 3060 3260 3465 3670 3875 4065 4250 4440 4625										
65 km/h	1880 2050 2220 2390 2560 2725 2895 3065 3235 3425 3615 3800 3990										

Ø Pulgadas	Descripción	CAI	S mm	D mm	R' mm	Cdr. mm	Llanta recomendada	Llanta permitida	Cámara de aire (Código)	Volumen interno al 75% (litros)	Profundidad de la banda de rodamiento (mm)
28	400/80 R28 158A8/153D IND	219659	412	1354	615	4094	DW13	W12 W13		159	26
	TL NUEVO										
Bar	1.6 1.8 2.0 2.2 2.4 2.6 2.8 3.0 3.2 3.4 3.6 3.8 4.0 4.2 4.4										
Psi	23 26 29 32 35 38 41 44 46 49 52 55 58 61 64										
Stat	3830 4255 4680 5105 5530 5955 6375 6800 7225 7650 8075 8500 8925 9350 9775										
10 km/h Cyc	2500 2775 3055 3330 3605 3885 4160 4435 4710 4990 5265 5545 5820 6100 6375										
25 km/h	2255 2460 2665 2870 3075 3280 3485 3690 3895 4100 4310 4515 4720										
30 km/h	2175 2375 2570 2770 2970 3165 3365 3560 3760 3955 4155 4350 4545										
40 km/h	2060 2245 2430 2615 2805 2990 3175 3360 3545 3720 3900 4075 4250										
50 km/h	2060 2245 2430 2615 2805 2990 3175 3360 3545 3720 3900 4075 4250										
65 km/h	1770 1930 2090 2245 2405 2565 2725 2880 3040 3190 3345 3495 3645										

Ø Pulgadas	Descripción	CAI	S mm	D mm	R' mm	Cdr. mm	Llanta recomendada	Llanta permitida	Cámara de aire (Código)	Volumen interno al 75% (litros)	Profundidad de la banda de rodamiento (mm)
28	440/80 R28 163A8/158D IND	439765	450	1410	635	4283	DW14L	DW15L	822	259	26
	TL NUEVO										
	16.9 R28 (Equiv 18PR)										
Bar	1.6 1.8 2.0 2.2 2.4 2.6 2.8 3.0 3.2 3.4 3.6 3.8 4.0 4.2 4.4										
Psi	23 26 29 32 35 38 41 44 46 49 52 55 58 61 64										
Stat	4370 4930 5485 6045 6605 7165 7720 8280 8840 9395 9955 10515 11075 11630 12190										
10 km/h Cyc	2850 3275 3700 4125 4550 4975 5400 5825 6250 6675 7100 7525 7950										
25 km/h	2620 2855 3090 3325 3565 3800 4035 4270 4505 4730 4960 5185 5410										
30 km/h	2525 2750 2975 3200 3425 3645 3870 4095 4320 4545 4770 4990 5215										
40 km/h	2360 2570 2780 2990 3200 3405 3615 3825 4035 4245 4455 4665 4875										
50 km/h	2360 2570 2780 2990 3200 3405 3615 3825 4035 4245 4455 4665 4875										
65 km/h	2035 2210 2390 2565 2745 2920 3095 3275 3450 3650 3850 4050 4250										

* Consultar las notas al final de las tablas de esta gama.

MICHELIN® CROSSGRIP

Características y presiones en (Bar) y (Psi): carga por neumático en kg*

Ø Pulgadas	Descripción	CAI	S mm	D mm	R' mm	Cdr. mm	Llanta recomendada	Llanta permitida	Cámara de aire (Código)	Volumen interno al 75% (litros)	Profundidad de la banda de rodamiento (mm)
38	480/80 R38 166A8/161D IND TL NUEVO 18.4 R38	846732	480	1751	791	5272	DW15L		786	416	29
Bar	1.6 1.8 2.0 2.2 2.4 2.6 2.8 3.0 3.2 3.4 3.6 3.8 4.0 4.2 4.4										
Psi	23 26 29 32 35 38 41 44 46 49 52 55 58 61 64										
Stat	5925 6600 7275 7950 8625 9220 9815 10410 11000 11595 12190										
10 km/h Cyc	3865 4305 4745 5185 5625 6015 6400 6790 7175 7565 7950										
25 km/h	3260 3570 3885 4195 4505 4785 5065 5340 5620										
30 km/h	3200 3505 3810 4115 4420 4695 4965 5240 5510										
40 km/h	3075 3370 3665 3955 4250 4515 4775 5040 5300										
50 km/h	3075 3370 3665 3955 4250 4515 4775 5040 5300										
65 km/h	2690 2950 3205 3465 3720 3950 4180 4410 4625										

***IMPORTANTE:**

La presión de inflado se determina siempre en función de la carga por neumático, de la velocidad y del trabajo a realizar. Las recomendaciones anteriores se facilitan con la salvedad de modificaciones posteriores a la fecha de difusión de estas tablas (junio de 2018). Los datos técnicos pueden sufrir modificaciones sin previo aviso.

- Para uso en laderas: añadir 0.4 Bar.
- Para uso intensivo en carretera: añadir 0.4 Bar.
- Stat: carga estática.
- 10 km/h Cyc: velocidad máxima de 10 km/h con carga cíclica.



MICHELIN® XF

ESTRUCTURA RADIAL DE ACERO PARA AUMENTAR LA DURACIÓN Y TRACCIÓN DEL NEUMÁTICO



Neumático RADIAL



COMODIDAD

- Protección del conductor y del vehículo



DURACIÓN

- Resistencia del casco demostrada



VERSATILIDAD

- Eficiente en todas las superficies



Excavadoras de ruedas

* Respecto al neumático diagonal del competidor principal.

DIMENSIONES

445/70 R19.5 173A8/180A2 TL

445/70 R22.5 175A8/182A2 TL

MICHELIN® XF

Características y presiones en (Bar) y (Psi): carga por neumático en kg*

Ø Pulgadas	Descripción	CAI	S mm	D mm	R' mm	Cdr. mm	Llanta recomendada	Llanta permitida	Cámara de aire (Código)	Volumen interno al 75% (litros)	Profundidad de la banda de rodamiento (mm)
19.5	445/70 R19.5 173A8/180A2 TL <i>18 R19.5</i>	489102	452	1110	499	3331	14			165	18
Bar	3.5 3.8 4.0 4.4 4.8 5.2 5.6 6.0 6.2 6.4 6.6 6.8 7.0 7.2 7.5										
Psi	51 55 58 64 70 75 81 87 90 93 96 99 102 104 109										
Stat	6580 7060 7385 8025 8665 9310 9950 10595 10915 11235 11555 11875 12200 12520 13000										
10 km/h**	4050 4345 4545 4940 5335 5730 6125 6520 6715 6915 7110 7310 7505 7705 8000										
20 km/h	3585 3850 4025 4375 4725 5075 5425 5775 5950 6125 6300 6475 6650 6825 7085										
30 km/h	3420 3670 3840 4170 4505 4840 5175 5510 5675 5840 6010 6175 6345 6510 6760										
35 km/h	3355 3600 3765 4090 4420 4745 5075 5400 5565 5730 5895 6055 6220 6385 6630										
40 km/h	3290 3530 3690 4010 4335 4655 4975 5295 5455 5615 5780 5940 6100 6260 6500										

Ø Pulgadas	Descripción	CAI	S mm	D mm	R' mm	Cdr. mm	Llanta recomendada	Llanta permitida	Cámara de aire (Código)	Volumen interno al 75% (litros)	Profundidad de la banda de rodamiento (mm)
22.5	445/70 R22.5 175A8/182A2 TL <i>18 R22.5</i>	073522	452	1192	539	3582	14			191	20
Bar	3.5 3.8 4.0 4.4 4.8 5.2 5.6 6.0 6.2 6.4 6.6 6.8 7.0 7.2 7.5										
Psi	51 55 58 64 70 75 81 87 90 93 96 99 102 104 109										
Stat	6980 7490 7835 8515 9195 9880 10560 11245 11585 11925 12265 12605 12950 13290 13800										
10 km/h**	4300 4615 4825 5245 5665 6085 6505 6925 7135 7345 7555 7765 7975 8185 8500										
20 km/h	3805 4085 4270 4640 5010 5385 5755 6125 6315 6500 6685 6870 7055 7240 7520										
30 km/h	3635 3900 4080 4435 4785 5140 5495 5850 6030 6205 6380 6560 6735 6915 7180										
35 km/h	3560 3820 3995 4345 4690 5040 5385 5735 5910 6085 6255 6430 6605 6780 7040										
40 km/h	3490 3745 3915 4255 4600 4940 5280 5620 5790 5960 6135 6305 6475 6645 6900										

***IMPORTANTE:**

La presión de inflado se determina siempre en función de la carga por neumático, de la velocidad y del trabajo a realizar. Las recomendaciones anteriores se facilitan con la salvedad de modificaciones posteriores a la fecha de difusión de estas tablas (junio de 2018). Los datos técnicos pueden sufrir modificaciones sin previo aviso.

- Para uso en laderas: añadir 0.4 Bar.
- Para uso intensivo en carretera: añadir 0.4 Bar.
- Stat: carga estática.
- **10 km/h LT (bajo torque) (velocidad máxima 10 km/h).



MICHELIN® XM 47

**GRAN COMODIDAD EN
LA CARRETERA Y BUENA
ADHERENCIA EN OTRAS
CONDICIONES**



**Para camiones multifuncionales fuera de la carretera;
neumático radial con capacidad de hasta 90 km/h***



VELOCIDAD

• Puede alcanzar los 90km/h* con un gran nivel de seguridad



ROBUSTEZ

• Estructura reforzada



DURACIÓN

• Resistencia del casco demostrada



DIMENSIONES

405/70 R20 136G TL

425/75 R20 148G TL

445/70 R24 151G TL

495/70 R24 155G TL

MICHELIN® XM 47

Características y presiones en (Bar) y (Psi): carga por neumático en kg*

Ø Pulgadas	Descripción	CAI	S mm	D mm	R' mm	Cdr. mm	Llanta recomendada	Llanta permitida	Cámara de aire (Código)	Volumen interno al 75% (litros)	Profundidad de la banda de rodamiento (mm)
20	405/70 R20 136G TL	123708	395	1076	482	3194	11	11SDC W10	664 o conjunta R1681	137	28
Bar	1.0 1.2 1.6 1.8 2.0 2.2 2.4 2.6 2.8 3.0 3.2 3.4 3.6 3.8 4.1										
Psi	15 17 23 26 29 32 35 38 41 44 46 49 52 55 59										
Stat	1950 2185 2655 2890 3125 3365 3600 3835 4070 4305 4540 4775 5010 5245 5600										
10 km/h**	1400 1570 1910 2080 2250 2420 2590 2755 2925 3095 3265 3435 3605 3775 4030										
30 km/h	970 1090 1325 1440 1560 1680 1795 1915 2035 2150 2270 2385 2505 2625 2800										
40 km/h	900 1010 1225 1335 1440 1550 1660 1765 1875 1985 2090 2200 2310 2415 2580										
65 km/h	850 950 1155 1260 1360 1460 1565 1665 1765 1870 1970 2075 2175 2275 2430										
90 km/h	780 875 1065 1155 1250 1345 1440 1535 1630 1720 1815 1910 2005 2100 2240										

Ø Pulgadas	Descripción	CAI	S mm	D mm	R' mm	Cdr. mm	Llanta recomendada	Llanta permitida	Cámara de aire (Código)	Volumen interno al 75% (litros)	Profundidad de la banda de rodamiento (mm)
20	425/75 R20 148G TL	123706	450	1147	509	3398	13	11 11SDC 13SDC	664 o conjunta R1681	185	30
Bar	1.0 1.2 1.6 1.8 2.0 2.2 2.4 2.6 2.8 3.0 3.2 3.4 3.6 3.8 4.1										
Psi	15 17 23 26 29 32 35 38 41 44 46 49 52 55 59										
Stat	2750 3080 3740 4075 4405 4735 5065 5395 5725 6055 6385 6720 7050 7380 7875										
10 km/h**	1970 2210 2685 2925 3165 3400 3640 3880 4120 4355 4595 4835 5075 5310 5670										
30 km/h	1370 1535 1865 2035 2200 2365 2530 2695 2860 3030 3195 3360 3525 3690 3940										
40 km/h	1260 1410 1715 1870 2020 2175 2325 2480 2630 2785 2935 3085 3240 3390 3620										
65 km/h	1190 1335 1620 1765 1910 2055 2195 2340 2485 2630 2775 2915 3060 3205 3420										
90 km/h	1100 1230 1495 1630 1760 1895 2025 2160 2290 2425 2555 2685 2820 2950 3150										

Ø Pulgadas	Descripción	CAI	S mm	D mm	R' mm	Cdr. mm	Llanta recomendada	Llanta permitida	Cámara de aire (Código)	Volumen interno al 75% (litros)	Profundidad de la banda de rodamiento (mm)
24	445/70 R24 151G TL	123642	462	1239	562	3689	DW15L	DW14L W14L W15L	710	210	34
Bar	1.0 1.2 1.6 1.8 2.0 2.2 2.4 2.6 2.8 3.0 3.2 3.4 3.6 3.8 4.1										
Psi	15 17 23 26 29 32 35 38 41 44 46 49 52 55 59										
Stat	3000 3365 4090 4450 4815 5175 5540 5905 6265 6630 6990 7355 7720 8080 8625										
10 km/h**	2160 2420 2945 3205 3465 3730 3990 4250 4510 4775 5035 5295 5555 5820 6210										
30 km/h	1500 1680 2045 2225 2405 2590 2770 2950 3130 3315 3495 3675 3855 4040 4310										
40 km/h	1380 1545 1880 2050 2215 2385 2550 2715 2885 3050 3220 3385 3550 3720 3970										
65 km/h	1300 1455 1770 1930 2085 2245 2400 2560 2715 2875 3030 3190 3345 3505 3740										
90 km/h	1200 1345 1635 1780 1925 2070 2215 2360 2505 2650 2795 2940 3085 3230 3450										

* Consultar las notas al final de las tablas de esta gama.

MICHELIN® XM 47

Características y presiones en (Bar) y (Psi): carga por neumático en kg*

Ø Pulgadas	Descripción	CAI	S mm	D mm	R' mm	Cdr. mm	Llanta recomendada	Llanta permitida	Cámara de aire (Código)	Volumen interno al 75% (litros)	Profundidad de la banda de rodamiento (mm)
24	495/70 R24 155G TL	123620	508	1311	581	3883	DW16L	W16L	710	248	35
Bar	1.0 1.2 1.6 1.8 2.0 2.2 2.4 2.6 2.8 3.0 3.2 3.4 3.6 3.8 4.1										
Psi	15 17 23 26 29 32 35 38 41 44 46 49 52 55 59										
Stat	3375 3785 4600 5005 5415 5825 6230 6640 7050 7455 7865 8270 8680 9090 9700										
10 km/h**	2430 2725 3310 3605 3900 4190 4485 4780 5070 5365 5660 5955 6245 6540 6980										
30 km/h	1690 1895 2300 2505 2705 2910 3115 3315 3520 3720 3925 4130 4330 4535 4840										
40 km/h	1550 1740 2115 2300 2490 2675 2865 3050 3240 3425 3615 3805 3990 4180 4460										
65 km/h	1460 1635 1990 2165 2345 2520 2695 2875 3050 3230 3405 3580 3760 3935 4200										
90 km/h	1350 1515 1840 2005 2165 2330 2495 2655 2820 2980 3145 3310 3470 3635 3880										

***IMPORTANTE:**

La presión de inflado se determina siempre en función de la carga por neumático, de la velocidad y del trabajo a realizar. Las recomendaciones anteriores se facilitan con la salvedad de modificaciones posteriores a la fecha de difusión de estas tablas (junio de 2018). Los datos técnicos pueden sufrir modificaciones sin previo aviso.

- Para uso en laderas: añadir 0.4 Bar.
- Para uso intensivo en carretera: añadir 0.4 Bar.
- Stat: carga estática.
- **10 km/h LT (bajo torque) (velocidad máxima 10 km/h).



MICHELIN® BIBSTEEL ALL TERRAIN

**ESTRUCTURA RADIAL
REFORZADA, MEJOR
TRACCIÓN Y SIN
INTERRUPCIONES**



COMODIDAD

- Protección para el conductor y el vehículo



TRACCIÓN

- Estructura radial y banda de rodamiento con diseño abierto



ROBUSTEZ

- Estructura 100% de acero para una mayor resistencia a los pinchazos



DURACIÓN

- Resistencia del casco demostrada



Minicargadores



Telescópicas

DIMENSIONES

210/70 R15 117A8/117B IND TL

260/70 R16.5 129A8/129B IND TL

300/70 R16.5 137A8/137B IND TL

360/70 R17.5 148A8/148B IND TL

MICHELIN® BIBSTEEL ALL TERRAIN

Características y presiones en (Bar) y (Psi): carga por neumático en kg*

Ø Pulgadas	Descripción	CAI	S mm	D mm	R' mm	Cdr. mm	Llanta recomendada	Llanta permitida	Cámara de aire (Código)	Volumen interno al 75% (litros)	Profundidad de la banda de rodamiento (mm)
15	210/70 R15 117A8/117B IND TL (27 x 8.50 R15) Equiv 8PR equivalencia de la medida 215/70 R15	085459	209	680	314	2033	7			26	15
Bar	1.5 1.8 2.2 2.6 3.0 3.2 3.4 3.6 3.8 4.0 4.2 4.4 4.6 4.8 5.0										
Psi	22 26 32 38 44 46 49 52 55 58 61 64 67 70 73										
Stat	1100 1270 1485 1695 1905 2010 2115 2220 2325 2430 2535 2640 2745 2850 2955										
25 km/h	530 615 720 820 920 970 1020 1070 1125 1175 1225 1275 1330 1380 1430										
40 km/h	475 550 645 740 830 875 920 965 1010 1055 1105 1150 1195 1240 1285										
50 km/h	475 550 645 740 830 875 920 965 1010 1055 1105 1150 1195 1240 1285										

Ø Pulgadas	Descripción	CAI	S mm	D mm	R' mm	Cdr. mm	Llanta recomendada	Llanta permitida	Cámara de aire (Código)	Volumen interno al 75% (litros)	Profundidad de la banda de rodamiento (mm)
16.5	260/70 R16.5 129A8/129B IND TL (10 R16.5) Equiv 12PR equivalencia de la medida 265/70 R16.5	176281	263	774	355	2310	8.25		184	47	20
Bar	1.5 1.8 2.2 2.6 3.0 3.2 3.4 3.6 3.8 4.0 4.2 4.4 4.6 4.8 5.0										
Psi	22 26 32 38 44 46 49 52 55 58 61 64 67 70 73										
Stat	1590 1810 2110 2415 2720 2870 3025 3180 3330 3485 3640 3795 3945 4100 4255										
25 km/h	760 870 1015 1165 1315 1390 1465 1540 1610 1685 1760 1835 1905 1980 2055										
40 km/h	690 785 915 1050 1185 1250 1315 1385 1450 1515 1585 1650 1715 1785 1850										
50 km/h	690 785 915 1050 1185 1250 1315 1385 1450 1515 1585 1650 1715 1785 1850										

Ø Pulgadas	Descripción	CAI	S mm	D mm	R' mm	Cdr. mm	Llanta recomendada	Llanta permitida	Cámara de aire (Código)	Volumen interno al 75% (litros)	Profundidad de la banda de rodamiento (mm)
16.5	300/70 R16.5 137A8/137B IND TL (12 R16.5) Equiv 14PR	625787	311	832	380	2481	9,75			65	23
Bar	1.5 1.8 2.2 2.6 3.0 3.2 3.4 3.6 3.8 4.0 4.2 4.4 4.6 4.8 5.0										
Psi	22 26 32 38 44 46 49 52 55 58 61 64 67 70 73										
Stat	2010 2270 2630 3005 3380 3565 3755 3950 4140 4330 4525 4715 4905 5100 5290										
25 km/h	970 1095 1270 1450 1630 1720 1810 1905 1995 2090 2180 2275 2365 2460 2550										
40 km/h	875 985 1140 1305 1470 1550 1635 1715 1800 1885 1965 2050 2135 2215 2300										
50 km/h	875 985 1140 1305 1470 1550 1635 1715 1800 1885 1965 2050 2135 2215 2300										

* Consultar las notas al final de las tablas de esta gama.

MICHELIN® BIBSTEEL ALL TERRAIN

Características y presiones en (Bar) y (Psi): carga por neumático en kg*

Ø Pulgadas	Descripción	CAI	S mm	D mm	R' mm	Cdr. mm	Llanta recomendada			Llanta permitida		Cámara de aire (Código)	Volumen interno al 75% (litros)	Profundidad de la banda de rodamiento (mm)	
17.5	360/70 R17.5 148A8/148B IND TL	360353	351	949	429	2823	10.5						99	26	
Bar	1.5 1.8 2.2 2.6 3.0 3.2 3.4 3.6 3.8 4.0 4.2 4.4 4.6 4.8 5.0														
Psi	22 26 32 38 44 46 49 52 55 58 61 64 67 70 73														
Stat	2715 3105 3620 4140 4660 4920 5175 5435 5695 5955 6215 6475 6730 6990 7250														
25 km/h	1300 1490 1740 1990 2245 2370 2495 2620 2745 2870 2995 3125 3250 3375 3500														
40 km/h	1180 1350 1575 1800 2025 2135 2250 2360 2475 2585 2700 2810 2925 3035 3150														
50 km/h	1180 1350 1575 1800 2025 2135 2250 2360 2475 2585 2700 2810 2925 3035 3150														

***IMPORTANTE:**

La presión de inflado se determina siempre en función de la carga por neumático, de la velocidad y del trabajo a realizar. Las recomendaciones anteriores se facilitan con la salvedad de modificaciones posteriores a la fecha de difusión de estas tablas (junio de 2018). Los datos técnicos pueden sufrir modificaciones sin previo aviso.

- Para uso en laderas: añadir 0.4 Bar.
- Para uso intensivo en carretera: añadir 0.4 Bar.
- Stat: carga estática.



MICHELIN® BIBSTEEL HARD SURFACE

**ESTRUCTURA RADIAL
REFORZADA, MEJOR
TRACCIÓN Y SIN PAROS**



Neumático RADIAL



COMODIDAD

- Protección para el conductor y el vehículo



ROBUSTEZ

- Estructura 100% de acero para una mayor resistencia a los pinchazos



DURACIÓN

- Resistencia del casco demostrada



Mini cargadores



Telescópicas

DIMENSIONES

260/70 R16.5 129A8/129B IND TL

300/70 R16.5 137A8/137B IND TL

MICHELIN® BIBSTEEL HARD SURFACE

Características y presiones en (Bar) y (Psi): carga por neumático en kg*

Ø Pulgadas	Descripción	CAI	S mm	D mm	R' mm	Cdr. mm	Llanta recomendada	Llanta permitida	Cámara de aire (Código)	Volumen interno al 75% (litros)	Profundidad de la banda de rodamiento (mm)
16.5	260/70 R16.5 129A8/129B IND TL (10 R16.5) Equiv 12PR	275538	266	773	355	2307	8.25			45	18
Bar	1.5 1.8 2.2 2.6 3.0 3.2 3.4 3.6 3.8 4.0 4.2 4.4 4.6 4.8 5.0										
Psi	22 26 32 38 44 46 49 52 55 58 61 64 67 70 73										
Stat	1590 1810 2110 2415 2720 2870 3025 3180 3330 3485 3640 3795 3945 4100 4255										
25 km/h	760 870 1015 1165 1315 1390 1465 1540 1610 1685 1760 1835 1905 1980 2055										
40 km/h	690 785 915 1050 1185 1250 1315 1385 1450 1515 1585 1650 1715 1785 1850										
50 km/h	690 785 915 1050 1185 1250 1315 1385 1450 1515 1585 1650 1715 1785 1850										

Ø Pulgadas	Descripción	CAI	S mm	D mm	R' mm	Cdr. mm	Llanta recomendada	Llanta permitida	Cámara de aire (Código)	Volumen interno al 75% (litros)	Profundidad de la banda de rodamiento (mm)
16.5	300/70 R16.5 137A8/137B IND TL (12 R16.5) Equiv 14PR	241265	315	830	378	2477	9.75			65	21
Bar	1.5 1.8 2.2 2.6 3.0 3.2 3.4 3.6 3.8 4.0 4.2 4.4 4.6 4.8 5.0										
Psi	22 26 32 38 44 46 49 52 55 58 61 64 67 70 73										
Stat	2010 2270 2630 3005 3380 3565 3755 3950 4140 4330 4525 4715 4905 5100 5290										
25 km/h	970 1095 1270 1450 1630 1720 1810 1905 1995 2090 2180 2275 2365 2460 2550										
40 km/h	875 985 1140 1305 1470 1550 1635 1715 1800 1885 1965 2050 2135 2215 2300										
50 km/h	875 985 1140 1305 1470 1550 1635 1715 1800 1885 1965 2050 2135 2215 2300										

***IMPORTANTE:**

La presión de inflado se determina siempre en función de la carga por neumático, de la velocidad y del trabajo a realizar. Las recomendaciones anteriores se facilitan con la salvedad de modificaciones posteriores a la fecha de difusión de estas tablas (junio de 2018). Los datos técnicos pueden sufrir modificaciones sin previo aviso.

- Para uso en laderas: añadir 0.4 Bar.
- Para uso intensivo en carretera: añadir 0.4 Bar.
- Stat: carga estática.



MICHELIN® X TWEEL

**NEUMÁTICO RADIAL Y
ENSAMBLAJE SIN AIRE**

SIN MANTENIMIENTO:

- Una sola unidad que reemplaza al conjunto actual de neumáticos/ruedas/válvulas
- Sin necesidad de utilizar equipos complejos para el montaje de ruedas/neumáticos
- Sin necesidad de mantener la presión de aire

SIN COMPROMISO:

- Productividad aumentada
- Mayor estabilidad
- Más comodidad para el conductor
- Vida útil duradera

SIN PAROS:

- Sin riesgo y sin paros costosos



Mini cargadores

MSPN	Descripción	Medida	Carga máxima a 15 km/h	Diámetro	Circunferencia de rodamiento	Profundidad de piso	Peso
07013	12N16.5 TWEEL SSL ALL TERRAIN 2	12N16.5	1,996 kg.	33.1"	94.7"	24.6 mm	96 kg.
45604	X TWEEL SSL 2 Hard Surface Traction	12N16.5	1,996 kg.	33.9"	94.7"	38.1 mm	109 kg.
93405	X TWEEL SSL All Terrain 2	10N16.5	1,678 kg.	30.2"	86.8"	24.6 mm	73 kg.



MICHELIN® POWER CL

**NEUMÁTICO CON LONAS
CRUZADAS, RESISTENCIA
A LOS CORTES Y UNA
GRAN ESTABILIDAD**



ROBUSTEZ

- Casco con 6 a 8 lonas



NEUMÁTICO CON LONAS CRUZADAS

- Estabilidad vertical y lateral



DURACIÓN

- Gajos de gran tamaño



Retroexcavadoras



Cargadoras



Telescópicas

DIMENSIONES

280/80 -18 132A8 IND TL

340/80 -18 143A8 IND TL

280/80 -20 133A8 IND TL

340/80 -20 144A8 IND TL

400/70 -20 149A8 IND TL

400/70 -24 158A8 IND TL

460/70 -24 159A8 IND TL

400/80 -24 162A8 IND TL

500/70 -24 164A8 IND TL

440/80 -24 168A8 IND TL

480/80 -26 167A8 IND TL

440/80 -28 163 A8 IND TL

420/80 -30 155A8 IND TL

MICHELIN® POWER CL

Características y presiones en (Bar) y (Psi): carga por neumático en kg*

Ø Pulgadas	Descripción	CAI	S mm	D mm	R' mm	Cdr. mm	Llanta recomendada	Llanta permitida	Cámara de aire (Código)	Volumen interno al 75% (litros)	Profundidad de la banda de rodamiento (mm)
18	280/80 -18 132A8 IND TL <i>10.5/80 - 18 (Equiv 10PR)</i>	281778	288	902	413	2691	9	10 W10 W8 W9	438	80	26
Bar	1.0 1.2 1.6 2.0 2.4 2.8 3.2 3.6 3.8 4.0 4.2 4.4 4.6 4.8 5.0										
Psi	15 17 23 29 35 41 46 52 55 58 61 64 67 70 73										
Stat	1840 2025 2390 2760 3130 3495 3865 4230 4415 4600										
10 km/h Cyc	1200 1320 1560 1800 2040 2280 2520 2760 2880 3000										
10 km/h**	1000 1100 1300 1500 1700 1900 2100 2300 2400 2500										
25 km/h	850 935 1105 1275 1445 1610 1780 1950 2035 2120										
30 km/h	830 915 1080 1245 1415 1580 1745 1915 1995 2080										
40 km/h	800 880 1040 1200 1360 1520 1680 1840 1920 2000										

Ø Pulgadas	Descripción	CAI	S mm	D mm	R' mm	Cdr. mm	Llanta recomendada	Llanta permitida	Cámara de aire (Código)	Volumen interno al 75% (litros)	Profundidad de la banda de rodamiento (mm)
18	340/80 -18 143A8 IND TL <i>12.5/80 - 18 (Equiv 12PR)</i>	610873	353	1006	452	2988	11	10 11SDC 12 12SDC W10 W11	828 444	106	24
Bar	1.0 1.2 1.6 2.0 2.4 2.8 3.2 3.6 3.8 4.0 4.2 4.4 4.6 4.8 5.0										
Psi	15 17 23 29 35 41 46 52 55 58 61 64 67 70 73										
Stat	2510 2760 3260 3765 4265 4765 5265 5770 6020 6270										
10 km/h Cyc	1640 1805 2130 2455 2785 3110 3435 3765 3925 4090										
10 km/h**	1360 1495 1770 2045 2315 2590 2865 3135 3275 3410										
25 km/h	1155 1270 1505 1735 1965 2200 2430 2665 2780 2895										
30 km/h	1130 1245 1470 1695 1925 2150 2375 2605 2715 2830										
40 km/h	1090 1200 1420 1635 1855 2075 2295 2510 2620 2730										

Ø Pulgadas	Descripción	CAI	S mm	D mm	R' mm	Cdr. mm	Llanta recomendada	Llanta permitida	Cámara de aire (Código)	Volumen interno al 75% (litros)	Profundidad de la banda de rodamiento (mm)
20	280/80 -20 133A8 IND TL <i>10.5/80 - 20 (Equiv 10PR)</i>	694767	287	947	435	2828	9	10 W10 W8 W9	542	86	27
Bar	1.0 1.2 1.6 2.0 2.4 2.8 3.2 3.6 3.8 4.0 4.2 4.4 4.6 4.8 5.0										
Psi	15 17 23 29 35 41 46 52 55 58 61 64 67 70 73										
Stat	1900 2090 2470 2845 3225 3605 3985 4360 4550 4740										
10 km/h Cyc	1240 1365 1610 1855 2105 2350 2595 2845 2965 3090										
10 km/h**	1030 1135 1340 1545 1755 1960 2165 2375 2475 2580										
25 km/h	870 960 1135 1310 1485 1660 1835 2010 2095 2185										
30 km/h	860 945 1115 1285 1455 1630 1800 1970 2055 2140										
40 km/h	820 905 1070 1235 1400 1565 1730 1895 1975 2060										

* Consultar las notas al final de las tablas de esta gama.

MICHELIN® POWER CL

Características y presiones en (Bar) y (Psi): carga por neumático en kg*

Ø Pulgadas	Descripción	CAI	S mm	D mm	R' mm	Cdr. mm	Llanta recomendada	Llanta permitida	Cámara de aire (Código)	Volumen interno al 75% (litros)	Profundidad de la banda de rodamiento (mm)
20	340/80 -20 144A8 IND TL 12.5/80 -20 (Equiv 12PR)	495503	337	1045	474	3112	11	10 11SDC 12 12SDC W10 W11	664 444	113	25
Bar	1.0 1.2 1.6 2.0	2.4 2.8 3.2 3.6 3.8 4.0 4.2 4.4 4.6 4.8 5.0									
Psi	15 17 23 29	35 41 46 52 55 58 61 64 67 70 73									
Stat	2580 2835 3350 3865	4380 4895 5410 5925 6185 6440									
10 km/h Cyc	1680 1850 2185 2520	2855 3190 3530 3865 4030 4200									
10 km/h**	1400 1540 1820 2100	2380 2660 2940 3220 3360 3500									
25 km/h	1185 1305 1540 1780	2020 2255 2495 2730 2850 2970									
30 km/h	1160 1275 1510 1745	1975 2210 2445 2675 2795 2910									
40 km/h	1120 1230 1455 1680	1905 2130 2350 2575 2690 2800									

Ø Pulgadas	Descripción	CAI	S mm	D mm	R' mm	Cdr. mm	Llanta recomendada	Llanta permitida	Cámara de aire (Código)	Volumen interno al 75% (litros)	Profundidad de la banda de rodamiento (mm)
20	400/70 -20 149A8 IND TL 16.0/70 -20 / 405/70 -20 (Equiv 16PR)	346809	405	1065	480	3167	13	12 12SDC 13SDC 14	664	129	29
Bar	1.0 1.2 1.6 2.0	2.4 2.8 3.2 3.6 3.8 4.0 4.2 4.4 4.6 4.8 5.0									
Psi	15 17 23 29	35 41 46 52 55 58 61 64 67 70 73									
Stat	2990 3290 3890 4485	5085 5685 6285 6880 7180 7480									
10 km/h Cyc	1950 2145 2535 2925	3315 3710 4100 4490 4685 4880									
10 km/h**	1630 1790 2115 2440	2765 3090 3410 3735 3900 4060									
25 km/h	1380 1520 1795 2070	2345 2620 2895 3170 3305 3445									
30 km/h	1350 1485 1755 2025	2295 2570 2840 3110 3245 3380									
40 km/h	1300 1430 1690 1950	2210 2470 2730 2990 3120 3250									

Ø Pulgadas	Descripción	CAI	S mm	D mm	R' mm	Cdr. mm	Llanta recomendada	Llanta permitida	Cámara de aire (Código)	Volumen interno al 75% (litros)	Profundidad de la banda de rodamiento (mm)
24	400/70 -24 158A8 IND TL 16.0/70 -24 / 405/70 -24 (Equiv 20PR)	407878	418	1173	535	3497	DW13	13 14 DW14L	703	165	29
Bar	1.0 1.2 1.6 2.0	2.4 2.8 3.2 3.6 3.8 4.0 4.2 4.4 4.6 4.8 5.0									
Psi	15 17 23 29	35 41 46 52 55 58 61 64 67 70 73									
Stat	3290 3615 4265 4910	5560 6210 6855 7505 7830 8155 8480 8800 9125 9450 9775									
10 km/h Cyc	2145 2355 2780 3205	3625 4050 4470 4895 5105 5320 5530 5740 5950 6165 6375									
10 km/h**	1790 1965 2320 2670	3025 3375 3730 4080 4260 4435 4610 4785 4965 5140 5315									
25 km/h	1515 1665 1965 2265	2560 2860 3160 3460 3610 3760 3905 4055 4205 4355 4505									
30 km/h	1485 1630 1925 2220	2510 2805 3100 3395 3540 3685 3835 3980 4125 4275 4420									
40 km/h	1430 1570 1855 2135	2415 2700 2980 3265 3405 3545 3685 3825 3970 4110 4250									

* Consultar las notas al final de las tablas de esta gama.

MICHELIN® POWER CL

Características y presiones en (Bar) y (Psi): carga por neumático en kg*

Ø Pulgadas	Descripción	CAI	S mm	D mm	R' mm	Cdr. mm	Llanta recomendada	Llanta permitida	Cámara de aire (Código)	Volumen interno al 75% (litros)	Profundidad de la banda de rodamiento (mm)	
24	460/70 -24 159A8 IND TL 17.5 L - 24 (Equiv 18PR)	474764	457	1241	558	3687	DW15L	14 16 DW14L DW16L	710	217	29	
Bar	1.0 1.2 1.6 2.0	2.4 2.8 3.2 3.6 3.8 4.0 4.2 4.4 4.6 4.8 5.0	15 17 23 29 35 41 46 52 55 64 67 70 73									
Stat	3450 3890 4770 5655	6535 7415 8295 9180 9620 10060										
10 km/h Cyc	2250 2535 3110 3685	4260 4835 5410 5985 6275 6560										
10 km/h**	1875 2115 2595 3075	3555 4030 4510 4990 5230 5470										
25 km/h	1590 1795 2200 2605	3015 3420 3825 4235 4435 4640										
30 km/h	1560 1760 2160 2555	2955 3355 3755 4150 4350 4550										
40 km/h	1500 1690 2075 2460	2840 3225 3610 3990 4185 4375										

Ø Pulgadas	Descripción	CAI	S mm	D mm	R' mm	Cdr. mm	Llanta recomendada	Llanta permitida	Cámara de aire (Código)	Volumen interno al 75% (litros)	Profundidad de la banda de rodamiento (mm)	
24	400/80 -24 162A8 IND TL 15.5/80 -24 (Equiv 20PR)	050267	414	1257	571	3743	DW13	DW14L, 13, 14, TW14L	703	187	29	
Bar	1.0 1.2 1.6 2.0	2.4 2.8 3.2 3.6 3.8 4.0 4.2 4.4 4.6 4.8 5.0	15 17 23 29 35 41 46 52 55 58 61 64 67 70 73									
Stat	3680 4045 4770 5495	6220 6945 7670 8395 8755 9120 9480 9845 10205 10570 10930										
10 km/h Cyc	2400 2635 3110 3585	4055 4530 5000 5475 5710 5950 6185 6420 6655 6895 7130										
10 km/h Cyc Dual	1500 1625 1875 2125	2375 2625 2875 3125 3250 3375 3500 3625 3750 3875 4000										
10 km/h**	2000 2195 2590 2985	3380 3775 4165 4560 4760 4955 5150 5350 5545 5745 5940										
25 km/h	1695 1860 2195 2530	2865 3200 3530 3865 4035 4200 4365 4535 4700 4870 5035										
30 km/h	1660 1825 2150 2480	2810 3135 3465 3790 3955 4120 4285 4450 4610 4775 4940										
40 km/h	1600 1760 2075 2390	2705 3020 3335 3650 3805 3965 4120 4280 4435 4595 4750										
30 km/h FRT	3000 3050 3150 3250	3350 3450 3550 3650 3700 3750 3800 3850 3900 3950 4000										

Ø Pulgadas	Descripción	CAI	S mm	D mm	R' mm	Cdr. mm	Llanta recomendada	Llanta permitida	Cámara de aire (Código)	Volumen interno al 75% (litros)	Profundidad de la banda de rodamiento (mm)	
24	500/70 -24 164A8 IND TL 19.5 L - 24 (Equiv 20PR)	196220	504	1315	588	3903	DW16L	16 DW15L	710	264	29	
Bar	1.0 1.2 1.6 2.0	2.4 2.8 3.2 3.6 3.8 4.0 4.2 4.4 4.6 4.8 5.0	15 17 23 29 35 41 46 52 55 58 61 64 67 70 73									
Stat	3910 4415 5430 6440	7450 8465 9475 10490 10995 11500										
10 km/h Cyc	2550 2880 3540 4200	4860 5520 6180 6840 7170 7500										
10 km/h**	2125 2400 2950 3500	4050 4600 5150 5700 5975 6250										
25 km/h	1800 2035 2500 2965	3435 3900 4365 4835 5065 5300										
30 km/h	1770 2000 2455 2915	3370 3830 4285 4745 4970 5200										
40 km/h	1700 1920 2360 2800	3240 3680 4120 4560 4780 5000										

* Consultar las notas al final de las tablas de esta gama.

MICHELIN® POWER CL

Características y presiones en (Bar) y (Psi): carga por neumático en kg*

Ø Pulgadas	Descripción	CAI	S mm	D mm	R' mm	Cdr. mm	Llanta recomendada	Llanta permitida	Cámara de aire (Código)	Volumen interno al 75% (litros)	Profundidad de la banda de rodamiento (mm)
24	440/80 -24 168A8 IND TL 16.9 - 24 / 16.5/85 - 24 (Equiv 22PR)	165629	460	1328	596	3944	DW15L	14 DW13 DW14L	710	236	29
Bar	1.0 1.2 1.6 2.0 2.4 2.8 3.2 3.6 3.8 4.0 4.2 4.4 4.6 4.8 5.0										
Psi	15 17 23 29 35 41 46 52 55 58 61 64 67 70 73										
Stat	4340 4765 5620 6475 7330 8185 9035 9890 10320 10745 11170 11600 12025 12455 12880										
10 km/h Cyc	2830 3110 3665 4225 4780 5335 5895 6450 6730 7010 7285 7565 7845 8120 8400										
10 km/h**	2360 2590 3055 3520 3985 4450 4910 5375 5610 5840 6070 6305 6535 6770 7000										
25 km/h	2005 2200 2595 2990 3380 3775 4165 4560 4755 4955 5150 5345 5540 5740 5935										
30 km/h	1960 2155 2540 2925 3310 3695 4085 4470 4660 4855 5050 5240 5435 5625 5820										
40 km/h	1890 2075 2445 2820 3190 3560 3930 4300 4485 4675 4860 5045 5230 5415 5600										

Ø Pulgadas	Descripción	CAI	S mm	D mm	R' mm	Cdr. mm	Llanta recomendada	Llanta permitida	Cámara de aire (Código)	Volumen interno al 75% (litros)	Profundidad de la banda de rodamiento (mm)
26	480/80 -26 167A8 IND TL 18.4 - 26 (Equiv 20PR)	226486	504	1417	637	4211	DW16L	DW15L	716	302	28
Bar	1.0 1.2 1.6 2.0 2.4 2.8 3.2 3.6 3.8 4.0 4.2 4.4 4.6 4.8 5.0										
Psi	15 17 23 29 35 41 46 52 55 58 61 64 67 70 73										
Stat	4920 5415 6400 7390 8375 9365 10350 11445 11990 12535										
10 km/h Cyc	3210 3530 4175 4820 5465 6105 6750 7465 7820 8175										
10 km/h**	2670 2940 3475 4015 4555 5090 5630 6225 6520 6815										
25 km/h	2270 2495 2950 3405 3860 4315 4770 5275 5530 5780										
30 km/h	2220 2445 2890 3340 3785 4235 4680 5175 5425 5670										
40 km/h	2140 2355 2785 3215 3640 4070 4500 4975 5215 5450										

Ø Pulgadas	Descripción	CAI	S mm	D mm	R' mm	Cdr. mm	Llanta recomendada	Llanta permitida	Cámara de aire (Código)	Volumen interno al 75% (litros)	Profundidad de la banda de rodamiento (mm)
28	440/80 -28 163 A8 IND TL 16.9 - 28 / 16.5/85 - 28 (Equiv 18PR)	691578	449	1412	642	4201	DW15L	DW13 DW14L	822	259	29
Bar	1.0 1.2 1.6 2.0 2.4 2.8 3.2 3.6 3.8 4.0 4.2 4.4 4.6 4.8 5.0										
Psi	15 17 23 29 35 41 46 52 55 58 61 64 67 70 73										
Stat	4370 4810 5685 6565 7445 8320 9200 10210 10710 11215										
10 km/h Cyc	2850 3135 3710 4280 4855 5425 6000 6660 6985 7315										
10 km/h**	2375 2615 3090 3570 4045 4525 5000 5550 5820 6095										
25 km/h	2015 2215 2620 3025 3430 3835 4240 4705 4940 5170										
30 km/h	1975 2175 2570 2970 3365 3765 4160 4615 4845 5070										
40 km/h	1900 2090 2475 2855 3235 3620 4000 4440 4655 4875										

* Consultar las notas al final de las tablas de esta gama.

MICHELIN® POWER CL

Características y presiones en (Bar) y (Psi): carga por neumático en kg*

Ø Pulgadas	Descripción	CAI	S mm	D mm	R' mm	Cdr. mm	Llanta recomendada		Llanta permitida		Cámara de aire (Código)	Volumen interno al 75% (litros)	Profundidad de la banda de rodamiento (mm)
30	420/80 -30 155A8 IND TL 16.9 - 30 (Equiv 14PR)	577845	432	1432	656	4296	DW15L		DW13 DW14L		754	245	36
Bar	1.0 1.2 1.6 2.0 2.4 2.8 3.2	3.6 3.8 4.0 4.2 4.4 4.6 4.8 5.0											
Psi	15 17 23 29 35 41 46	52 55 58 61 64 67 70 73											
10 km/h Cyc	2760	3040	3595	4150	4705	5260	5815						
10 km/h**	2300	2530	2995	3455	3920	4380	4845						
25 km/h	1950	2145	2540	2930	3325	3715	4110						
30 km/h	1915	2105	2490	2875	3260	3645	4030						
40 km/h	1840	2025	2395	2765	3135	3505	3875						

***IMPORTANTE:**

La presión de inflado se determina siempre en función de la carga por neumático, de la velocidad y del trabajo a realizar. Las recomendaciones anteriores se facilitan con la salvedad de modificaciones posteriores a la fecha de difusión de estas tablas (junio de 2018). Los datos técnicos pueden sufrir modificaciones sin previo aviso.

- Para uso en laderas: añadir 0.4 Bar.
- Para uso intensivo en carretera: añadir 0.4 Bar.
- Stat: carga estática.
- 10 km/h Cyc: velocidad máxima de 10 km/h con carga cíclica.
- **10 km/h LT (bajo torque) (velocidad máxima 10 km/h).



MICHELIN® POWER DIGGER

**NEUMÁTICO CON LONAS
CRUZADAS, RESISTENCIA
A LOS CORTES Y UNA
GRAN ESTABILIDAD**



RENTABILIDAD

- Gran capacidad de carga (147B) y una mayor resistencia al desgaste



ROBUSTEZ

- +2 lonas en el casco*



ESTABILIDAD

- Flancos 57% más gruesos*



Excavadoras de
ruedas

* Respecto al neumático diagonal del competidor principal.

DIMENSIONES

10.00-20 165A2/147B 16PR TT

MICHELIN® POWER DIGGER

Características y presiones en (Bar) y (Psi): carga por neumático en kg*

Ø Pulgadas	Descripción	CAI	S mm	D mm	R' mm	Cdr. mm	Llanta recomendada	Llanta permitida	Cámara de aire (Código)	Volumen interno al 75% (litros)	Profundidad de la banda de rodamiento (mm)
20	10.00-20 165A2/147B 16PR TT	263208	286	1050	488	3144	7.5T		20N	53	15
Bar	4.0 4.4 4.8 5.2 5.6 6.0 6.4 6.6 6.8 7.0 7.2 7.4 7.6 7.8 8.0										
Psi	58 64 70 75 81 87 93 96 99 102 104 107 110 113 116										
Stat	4000 4380 4760 5140 5520 5900 6260 6440 6620 6800 6980 7160 7340 7515 7690										
10 km/h**	2670 2925 3180 3430 3685 3940 4180 4300 4425 4545 4665 4785 4905 5030 5150										
20 km/h	2130 2330 2535 2735 2940 3140 3330 3425 3520 3615 3710 3805 3900 3995 4090										
30 km/h	1745 1910 2075 2240 2405 2570 2725 2805 2885 2965 3040 3120 3200 3285 3370										
35 km/h	1630 1785 1940 2095 2250 2405 2555 2625 2700 2775 2850 2925 2995 3065 3135										
50 km/h	1360 1560 1760 1960 2160 2360 2505 2575 2650 2720 2790 2865 2935 3005 3075										

***IMPORTANTE:**

La presión de inflado se determina siempre en función de la carga por neumático, de la velocidad y del trabajo a realizar. Las recomendaciones anteriores se facilitan con la salvedad de modificaciones posteriores a la fecha de difusión de estas tablas (junio de 2018). Los datos técnicos pueden sufrir modificaciones sin previo aviso.

• Stat: carga estática.

**10 km/h LT (bajo torque) (velocidad máxima 10 km/h).

MICHELIN AGRICULTURA

DOCUMENTACIÓN TÉCNICA DE NEUMÁTICOS

- 2019/2020



MICHELIN

AGRO.MICHELIN.COM

ÍNDICE

ELECCIÓN DEL NEUMÁTICO: USO Y PUESTA EN MARCHA	193
MARCAJE DE LOS NEUMÁTICOS	194
ÍNDICES DE CARGA Y CATEGORÍAS DE VELOCIDAD	195
INSTRUCCIONES PARA LA PUESTA EN MARCHA	196
CÁLCULO DEL AVANCE	197
CÁLCULO DEL% DE AVANCE DE LAS RUEDAS DELANTERAS	198
CÁLCULO DEL REPARTO DE CARGAS	199
REFERENCIAS DE LLANTAS Y JUNTAS TÓRICAS	201
REFERENCIAS DE CÁMARAS DE AIRE INTERNAS Y VÁLVULAS	202
DATOS TÉCNICOS DE LAS VÁLVULAS	205
INSTRUCCIONES PARA EL MONTAJE Y DESMONTAJE DE NEUMÁTICOS	207

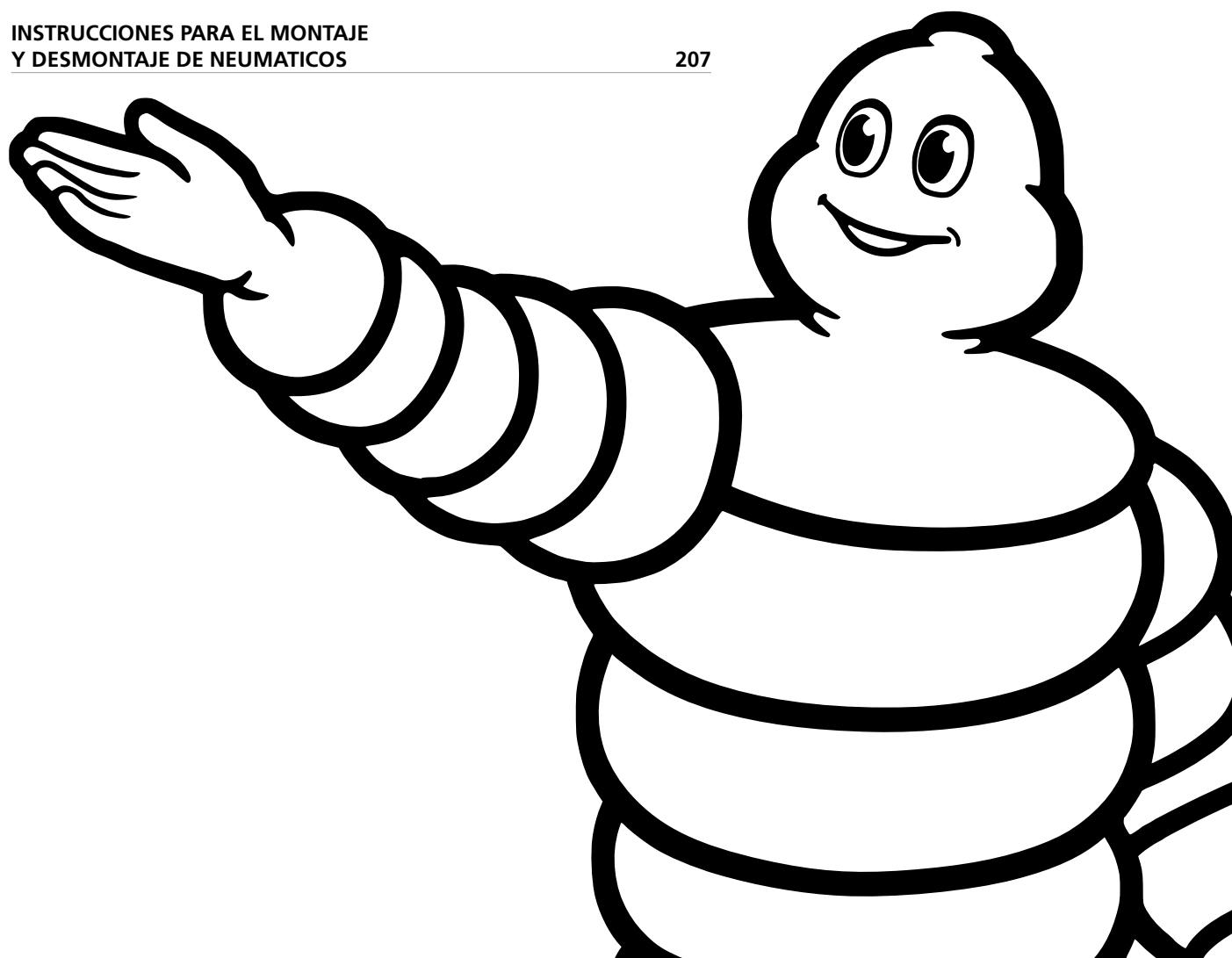

ELECCIÓN DEL NEUMÁTICO: USO Y PUESTA EN MARCHA

La elección del neumático debe ser conforme a la legislación y a los equipos recomendados por los fabricantes del vehículo o por un organismo oficial (dimensión, índice de carga, categoría de velocidad, estructura [radial o diagonal], etc.).

Se deben tener en cuenta las condiciones de uso del neumático para que su rendimiento responda a las expectativas del usuario.

En caso de realizar alguna modificación al equipo original del vehículo, es necesario asegurarse de que la solución propuesta respete la legislación vigente del país, y de revisar tanto las limitaciones del vehículo como las recomendaciones del fabricante (consulte la normativa local).

En algunos países, los vehículos que se modifiquen de esta forma deben obtener una autorización de uso por parte de las autoridades pertinentes.

Los neumáticos MICHELIN® están diseñados para un uso determinado. Cualquier otro uso se considera anómalo. Sin embargo, en algunos casos, MICHELIN® puede autorizar una exención que indicará las condiciones y los límites de uso permitidos.

MICHELIN® se deslinda de toda responsabilidad en caso del uso anómalo de sus neumáticos o del uso en ausencia de una exención expresa por escrito.

Todo neumático usado, desgastado o que haya estado presente en un accidente debe someterse a una revisión minuciosa por parte de un profesional antes de su montaje para garantizar la seguridad del usuario y el cumplimiento de la normativa vigente.

El mal uso o la elección incorrecta de un neumático también puede ocasionar el deterioro prematuro de ciertas piezas mecánicas.

MARCAJE DE LOS NEUMÁTICOS

■ CÓMO LEER EL MARCAJE DE UN NEUMÁTICO



XeoBib	Gama
VF = Very High Flexion	Prefijo que designa una categoría normalizada de neumáticos
650	Anchura de la sección nominal del neumático en mm
60	Proporción de aspecto (relación entre la altura del flanco y la sección nominal del neumático) en %
R	Estructura: «R» para la llanta radial; «-» para la llanta nominal diagonal
38	Diámetro en pulgadas
155	Índice de carga normalizada (ver página 195)
D	Categoría de velocidad normalizada (ver página 195)
Radial	Estructura
Tubeless	Neumático sin cámara de aire interna
Michelin® X®	Marca registrada

■ DIMENSIONES DEL NEUMÁTICO

S	Anchura de sección del neumático
R'	Radio con carga estática
D	Diámetro exterior = 2 R
∅	Diámetro interior

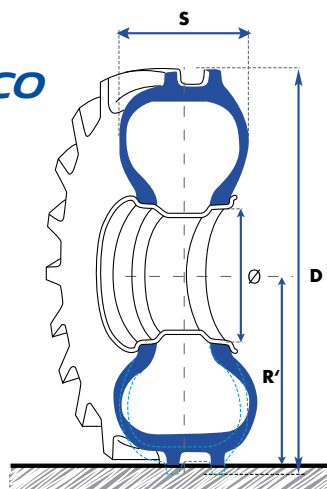

■ ESQUEMA DE LAS SERIES 42" Y EQUIVALENCIA DEL RIN DE 38"

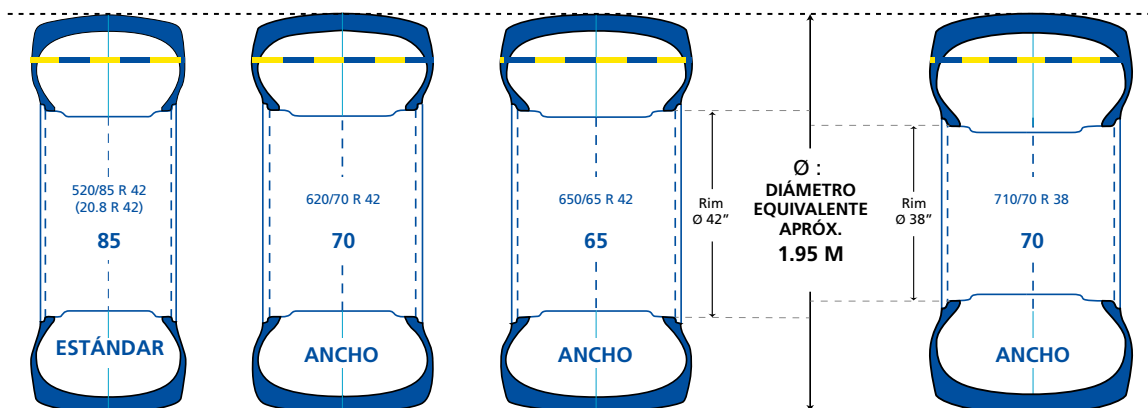

ÍNDICES DE CARGA Y CATEGORÍAS DE VELOCIDAD

Todos los neumáticos llevan una descripción que indica el índice de capacidad de carga (número) y la categoría de velocidad (letra o letra y número).

Las tablas que aparecen a continuación muestran los índices de carga y las categorías de velocidad con sus valores correspondientes.

ÍNDICES DE CARGA

Índice	Carga en kg	Índice	Carga en kg	Índice	Carga en kg	Índice	Carga en kg	Índice	Carga en kg	Índice	Carga en kg
101	825	117	1285	133	2060	149	3250	165	5150	181	8250
102	850	118	1320	134	2120	150	3350	166	5300	182	8500
103	875	119	1360	135	2180	151	3450	167	5450	183	8750
104	900	120	1400	136	2240	152	3550	168	5600	184	9000
105	925	121	1450	137	2300	153	3650	169	5800	185	9250
106	950	122	1500	138	2360	154	3750	170	6000	186	9500
107	975	123	1550	139	2430	155	3875	171	6150	187	9750
108	1000	124	1600	140	2500	156	4000	172	6300	188	10000
109	1030	125	1650	141	2575	157	4125	173	6500	189	10300
110	1060	126	1700	142	2650	158	4250	174	6700	190	10600
111	1090	127	1750	143	2725	159	4375	175	6900	191	10900
112	1120	128	1800	144	2800	160	4500	176	7100	192	11200
113	1150	129	1850	145	2900	161	4625	177	7300	193	11500
114	1180	130	1900	146	3000	162	4750	178	7500	194	11800
115	1215	131	1950	147	3075	163	4875	179	7750	195	12150
116	1250	132	2000	148	3150	164	5000	180	8000	196	12500

CATEGORÍAS DE VELOCIDAD

Categoría	Velocidad en km/h	Velocidad en mph
A2	10	6
A5	25	15
A6	30	20
A8	40	25
B	50	30
D	65	40
E	70	44
F	80	50
G	90	55
J	100	60

UNIDADES DE MEDIDA

1 centímetro	cm	= 0.3937 pulgadas	1 pulgadas	in	= 2.54 cm
1 metro	m	= 3.281 pies	1 pie	ft	= 0.3048 m
1 kilómetro	km	= 0.6214 milla	1 milla	mi	= 1.6093 km
1 litro	l	= 0.2199754 imp. galón	1 imp. galón	imp. gall.	= 4.545963 litros
1 kilogramo	kg	= 2.204622 libras	1 libra	lb	= 0.4535924 kg
1 fuerza de caballo	hp	= 735.499 W	1 kilovatio	kw	= 1.3596216173 hp
1 bar	bar	= 14.5037738 psi	1 bar	bar	= 100 kPa (kilo Pascal)
1 libra por pulgada cuadrada	psi	= 6.89476 kPa	1 imp. acre		= 0.4046842 ha
1 hectárea	ha	= 2.4711 imp. acre	1 pulgadas cuadrada (imp.)	sq in	= 6.451578 cm ²
1 cm cuadrado	cm²	= 0.1550 pulg. cuadrada (imp.)	1 tonelada	t	= 0.9842064 tn (imp)
1 ton (imp)	tn	= 1.016047 t	1 kilómetro/hora	km/h	= 0.62137 mph
1 milla por hora	mph	= 1.609344 km/h			

INSTRUCCIONES PARA LA PUESTA EN MARCHA

■ CÓMO DETERMINAR LA PRESIÓN DE INFLADO:

- La presión de inflado se establece siempre en función de la carga soportada por el neumático, de la velocidad y del trabajo a realizar.
- La carga que debe tomarse en cuenta es la más elevada. Para tractores:
 - Eje delantero: tractor con sus cargas/apero delantero en la posición de transporte y sin carga en el eje trasero.
 - Eje trasero: tractor con apero en la posición de transporte.

Nota: Para tractores con pala frontal, calcular con la carga máxima en la pala.

Para cosechadoras: con carga total (tolva llena), con barra de corte (o recolector).

Nota: Para cosechadoras, determinar la carga en el eje:

- Eje delantero con la barra de corte o el recolector.
- Eje trasero sin la barra de corte ni el recolector.
- Determinar la presión para el «uso en el campo» y el «uso en carretera» y utilizar la más elevada.
- Para el uso intensivo en carretera o en pendientes o laderas, seguir los consejos de las páginas “Características técnicas de los neumáticos MICHELIN®”.

■ USO

- Distribuir las cargas correctamente.
- Adaptar la forma de conducir a las condiciones (carga, velocidad, pendiente, ladera, estado de la carretera u otro terreno).

■ MANTENIMIENTO

- Revisar la presión de los neumáticos con regularidad.
- Verificar periódicamente el estado de los neumáticos y someterlos a una revisión por parte de un profesional debidamente cualificado.

Aviso:

- Los daños ocasionados por un pinchazo o golpe no siempre son visibles en el momento y podrían manifestarse posteriormente.
- Los neumáticos se deterioran, aunque no se utilicen.
- Para cualquier reparación, acudir a un profesional cualificado.

CÁLCULO DEL AVANCE

En el caso de los tractores con un sistema de doble tracción, tanto la relación mecánica como el avance deben respetarse en todos los casos para asegurar el correcto funcionamiento de la unidad de transmisión de la máquina. Esta regla no se aplica si la dimensión de las 4 ruedas es la misma.

La mayoría de los fabricantes de tractores imponen un avance de entre 0% y 6%. Este valor es específico y puede variar dependiendo del fabricante y del vehículo.

Un avance inadecuado:

- Aumenta el consumo de combustible
- Acelera el desgaste de los neumáticos traseros y delanteros
- Deteriora la unidad de transmisión del tractor más rápido
- Disminuye el rendimiento del tractor en la realización de algunos trabajos (p.Ej., La labranza)

Provocando:

- Una conexión brusca del eje delantero
- La pérdida de potencia y la disminución del rendimiento
- El deterioro de la tierra vegetal

Nota: ¡El eje delantero nunca debe estar conectado al circular en carretera!

Cálculo del avance:

$$\frac{(\text{CdR}_{\text{DEL}} \times R) - \text{CdR}_{\text{TRA}}}{\text{CdR}_{\text{TRA}}} \times 100 = \text{avance en \%}$$

CdR_{TRA} : circunferencia de la banda de rodamiento del neumático trasero (especificada en la documentación técnica)

CdR_{DEL} : Circunferencia de la banda de rodamiento del neumático frontal (especificada en la documentación técnica)

R: relación mecánica (determinada por el fabricante)

CÁLCULO DEL% DE AVANCE DE LAS RUEDAS DELANTERAS



Hacer una marca en los neumáticos delanteros y traseros tal y como se indica en la imagen.

■ PASO 1 :

EJE DELANTERO **NO CONECTADO** (sin doble tracción)

Hacer avanzar el tractor de modo que los neumáticos traseros den 10 giros, y contar al mismo tiempo el número de giros (**N**) que dé el neumático delantero.

■ PASO 2 :

EJE DELANTERO **CONECTADO** (con doble tracción)

Hacer avanzar el tractor de modo que los neumáticos traseros den 10 giros, y contar al mismo tiempo el número de giros (**N1**) que dé el neumático delantero.

$$\text{Cálculo del avance} = \frac{(N1 - N)}{N} \times 100$$

CÁLCULO DEL REPARTO DE CARGAS

MONTAJE SENCILLO

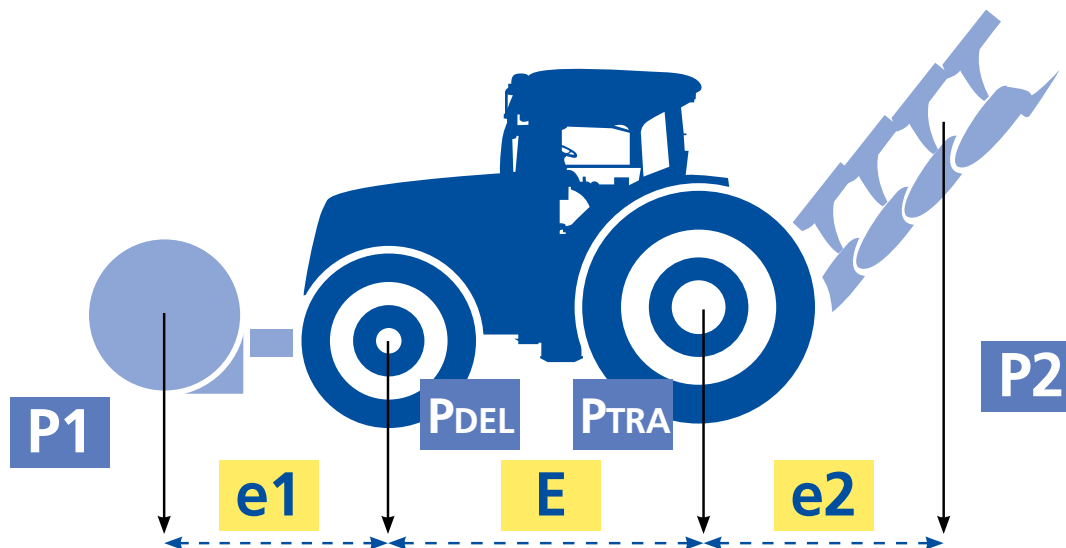

	Eje delantero (DEL)	Eje trasero (TRA)
Tractor (kg)	P_{DEL}	P_{TRA}
Apero o peso (kg)	P_1	P_2
Cálculo del apero o peso (kg)	$P_1 \times (e1/E)$	$P_2 \times (e2/E)$
Total del eje (kg)	$P_{DEL} + P_1 + [P_1 \times (e1/E)]$	$P_{TRA} + P_2 + [P_2 \times (e2/E)]$
Número de neumáticos	N_{del}	N_{tra}
Carga por neumático (kg)	Total del eje del / N_{del}	Total del eje tra / N_{tra}



Código QR para acceder a la aplicación de la calculadora de presión

Ejemplos :

Datos	Delantero	Trasero
Tractor (kg)	3 000	5 000
Apero o peso (kg)	1 000	2 000
Distancia (metros)	$E = 3 \text{ m} / e1 = 1,5 \text{ m} / e2 = 2,5 \text{ m}$	

Cálculos	Eje delantero (DEL)	Eje trasero (TRA)
Tractor (kg)	3 000	5 000
Apero o peso (kg)	1 000	2 000
Cálculo del apero o peso (kg)	$1\,000 \times (1,5 / 3) = 500$	$2\,000 \times (2,5 / 3) = 1\,666$
Total del eje (kg)	$3\,000 + 1\,000 + 500 = 4\,500$	$5\,000 + 2\,000 + 1\,666 = 8\,666$
Número de neumáticos	2	2
Carga por neumático (kg)	$4\,500 / 2 = 2\,250$	$8\,666 / 2 = 4\,333$

CÁLCULO DEL REPARTO DE CARGAS

■ MONTAJE GEMELADO "O TRIPLE"

- 1 - Dividir la carga del eje entre 4 en el caso del montaje gemelado (o entre 6 si es triple)
- 2 - Después, dividir el resultado obtenido entre 0.88 en el caso del montaje gemelado (o entre 0.82 si es triple)

* Para calcular la carga, ver la página anterior.

Ejemplo de cálculo para el montaje gemelado:

- Tractor con 650/85R38 MICHELIN® MACHXBIB 173A8/173B TL
- Carga del eje establecida = 14,000 kg
- Uso = arado de rastrojo

a) Si la fila Dual a la velocidad deseada se encuentra en la tabla de carga/presión:

- Dividir la carga total entre 4 (4 neumáticos)
- Utilizar la fila Dual para determinar la presión

b) Si la fila Dual a la velocidad deseada no se encuentra en la tabla de carga/presión:

- Dividir la carga total entre 4 (4 neumáticos)
- Dividir el resultado entre 0.88
- Usar la fila de la velocidad deseada de la tabla carga/presión

Ejemplo para una carga total de 14,000 kg en un eje trasero con montaje gemelado:

$$[14,000 / 4] / 0.88 = 3,977 \text{ kg}$$

Es decir, se recomienda una presión de 0.80 Bar para una velocidad de 30 km/h

Nota: En caso de un montaje triple, dividir la carga entre 6 y después dividir entre 0.82 para obtener la carga en cuestión.

REFERENCIAS DE LLANTAS Y JUNTAS TÓRICAS

Tipo de llanta	Dimensión	Dimensión F en mm	Dimensión H en mm	Dimensión P en mm
Llanta hueca estándar a 5°	2.50 C	63,5	16,5	
	3.00 D	76	18	
	3.50 D	89		
	4.00 E	101,5		18
	4.50 E	114,5	20	
	5.00 E	127		23,5
	5.375 I	136,5	16	23
	5.50 F	140		
	6.00 F	152,5	22,5	23,5
6.50 F	165			
Llanta hueca con apoyo cónico de las cejas a 5°	9	228,5		27
	11	279,5		
	12	305	25,5	
	13	330		31,5
	14	355,5		
	16	406,4	25,4	
Llanta hueca con apoyo cónico de las cejas a 15°	10.50	266,7		
	11.75	298,5		
	12.25	311		
	13.00	330		
	14.00	355,5		
	15.00	381		
	16.00	406,5	12,7	44
	AG 16.00	406,5		
	17.00	432		
	18.00	457		
	20.00	508		
	AG 20.00	508		
	AG 24.00	609,5		
	AG 28.00	711		
Llanta SDC	11	279,5		
	12	305	25,5	
	13	330		
	36.0 TH	914,4	38,1	
	36.0 VA	914,4	43,1	
Llanta W	W 6	152,4		23,8
	W 7	177,8	22,2	
	W 8	203,2		
	W 8L	203,2		
	W 9	228,6	25,4	
	W 10	254		
	W 10L	254	22,2	27
	W 11	279,4		
	W 12	304,8		
Llanta DW	W 13	330,2		
	W 14L	355,6	25,4	
	W 15L	381		
	W 16L	406,4		33
	W 18L	457,2		

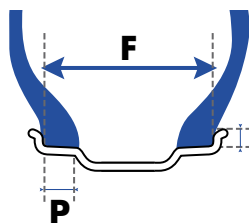

F = Anchura interior
H = Altura de pestaña (+/- 1 mm)
P = Anchura del apoyo

Tipo de llanta	Dimensión	Dimensión F en mm	Dimensión H en mm	Dimensión P en mm	
Llanta DW	DW 10	254			
	DW 11	279,4		27	
	DW 12	304,8			
	DW 13	330,2			
	DW 14L	355,6	25,4	36,5	
	DW 15L	381			
	DW 16L	406,4			
	DW 17L	431,8			
	DW 18L	457,2			
	DW 20B	508			
	DW 21B	533,4		50,8	
	DW 23B	584,2			
	DW 24B	609,5	28,6		
	DW 25B	635			
	DW 27B	686			
	DW 28B	711			
	DW 30B	762			
	Llanta TW	TW 13	330		27
		TW 14L	355,5		36,5
		TW 15L	381	25,5	
TW 16L		406,5			
TW 18L		457			
TW 20B		508			
TW 21B		533,5	29	50,8	
TW 23B		584			
TW 24B		609,5			
TW 25B		635			
Llanta DD	DD 16L	406,5	41	50,5	
	DD 18L	457			
Llanta MW	MW 20	508	29	50,8	
	MW 23	584			
	MW 25	635			
Llanta DH27B	DH 27B	686	29	54	

Si se autoriza la llanta DW, también se autoriza la llanta TW correspondiente (ETRTO)

JUNTAS TÓRICAS PARA LLANTA DE 3 PIEZAS

Referencia	Denominación	Uso	CAI
R 1681	Junta tórica OR 6.6 - 20	Para llanta 20" en 3 piezas	553215
R 1438	Junta tórica OR 2 - 25	Para llanta 25" en 3 piezas	553201
R 2052	Junta tórica OR 2 - 32	Para llanta 32" en 3 piezas	553055

Denominación de juntas tóricas:

- OR: Abreviatura de O-ring (junta tórica)
- El primer número designa la sección de la junta: un número entero cuyo valor se expresa en octavos de pulgada (p. ej.: 2 = 2/8").
- El segundo número designa el diámetro del apoyo de la llanta: un número entero expresado en pulgadas.

REFERENCIAS DE CÁMARAS DE AIRE INTERNAS Y VÁLVULAS

Apoyo	Dimensiones	Designación de la válvula	Descentrado de la válvula	Categoría KLEBER	CAI KLEBER	Categoría MICHELIN	CAI MICHELIN
6	3.50 4.00	10SC29	0	826	158611		
8	4.00	10SCH40	0	360	125528		
12	4.00	TR13	13			12C13	125674
	7.00	TR15	25	389	101397		
15	4.00	TR13	15			15CB13	125682
	5.00 6.70	TR13	22			15F13	125622
15,3	10.0/75 11.5/80 12.5/80	TR15	80	463	170029		
16	4.50	TR218A	19	420	101467	M420	834861
	5.50 6.00	TR15	60	182	170010	M182	884753
	6.00 6.50	TR218A	60	313	039318	M313	183634
	6.50 7.00	TR15	65	311	170014		
	7.50	TR218A	70	431	170000	M431	509471
	7.50	TR15	70	317	170016		
	10.00 11.00	TR218A	90	485	170030	M485	410859
	11LR 260/70 280/70	TR218A	65	184	171108	M184	764859
	10.50 270/65 275/65 320/65	TR218A	65	827	813635	M827	030552
18	7.50	TR218A	70	440	170001	M440	594387
	7.50	TR15	70	441	170023		
	10.5/80 280/80 260/70 280/70 270/65	TR218A	70	438	171109	M438	582674
	12.0 12.5 335/80 340/80 320/65 340/65	TR218A	90	444	170025	M444	756917
	12.0 12.5 335/80 340/80 13/65 320/65 335/65 340/65	TR15	80	828	057866	M828	126008
19	4.00 4.50	TR13	15	446	101417		
	6.00	TR15	50	452	170026		
20	7.50	TR218A	65	655	170004	M655	575125
	7.50	TR15	60	660	170033		
	9.5 260/70 280/70	TR218A	65	533	171110	M533	504653
	10.5 11.2 280/80 300/70 320/70	TR218A	90	542	171111		
	12.4 320/85 12.5/80 335/80 340/80 340/75	TR218A	90	444	170025	M444	756917
	12.5 14.5 14.9 335/80 340/80 340/75 +375/75 380/75 420/75 425/75 360/70 400/70 405/70 420/65 440/65	TR218A	90	664	171112	M664	657648
20,5	20.5 525/65	1964	75			19.5/20.5 UD	101280
	24-20.5	1837	100			20.5WAMD	101331
22,5	600/55	TR218A	90	716	170047	M716	346313
24	8.3 9.5 250/85	TR218A	70	686	170035	M686	820931
	11.2 12.4 280/85 320/85 320/70 360/70	TR218A	85	692	170037	M692	970338
	13.6 14.5 340/85 380/70 420/65	TR218A	85	700	170039	M700	519392
	14.9 380/85 400/80 400/70 420/70 440/65	TR218A	127	703	171114	M703	027015
	16.9 17.5LR 19.5LR 420/85 440/80 440/70 445/70 460/70 480/70 495/70 500/70 540/70 480/65 540/65	TR218A	100	710	170042	M710	460503





REFERENCIAS DE CÁMARAS DE AIRE INTERNAS Y VÁLVULAS

Apoyo	Dimensiones	Designación de la válvula	Descentrado de la válvula	Categoría KLEBER	CAI KLEBER	Categoría MICHELIN	CAI MICHELIN
26	18.4 480/80 VF520/80 480/70 520/70 580/70 VF620/70	TR218A	90	716	170047	M716	346313
	23.1 620/75 580/70 620/70	TR218A	110	830	823746	M830	036738
	620/70	TR218A	110	717	101447	M717	438361
	750/65	TR218A	160	833	975074		
26.5	600/55	TR218A	90	716	170047	M716	346313
28	9.5 11.2 280/85	TR218A	65	725	170050	M725	330841
	12.4 320/85 360/70	TR218A	85	726	170051	M726	316215
	13.6 340/85 380/70 420/65	TR218A	85	732	170053	M732	049533
	14.9 380/85 420/70 440/65 VF480/60	TR218A	85	821	170148	M821	483956
	16.9 19.5LR 420/85 440/80 480/70 480/65 540/65 VF520/60 VF600/60	TR218A	120	822	170149	M822	428511
	600/70 600/65	TR218A	110	717	101447	M717	438361
30	14.9 380/85 420/70	TR218A	90	734	170054	M734	626564
	16.9 420/90 420/85 420/80 480/70 540/65 VF540/65	TR218A	95	754	170058	M754	743325
	18.4 460/85 520/70 VF600/60	TR218A	95	757	170060	M757	579464
	23.1 520/85 620/75 IF620/75 VF620/75 600/70 IF600/70 VF620/70	TR218A		737	192251	M737	589735
32	8.3 9.5 210/95 230/95	TR218A	70	758	013109		
	11.2 270/95	TR218A	70	763	983325		
	12.4 320/85	TR218A	90	760	877890		
	24.5 30.5 680/85 IF680/85 650/75 680/75 800/70 IF800/70 800/65 IF800/65 900/60 IF900/60	TR218A	170	831	664520	M831	289134
34	16.9 380/85 VF380/85 420/85 VF420/85 480/70 IF480/70 540/65	TR218A	95	704	171115	M704	862196
	18.4 460/85 500/70 520/70 540/70 600/65 IF650/65 VF600/60 IF650/60	TR218A	100	823	170150	M823	164970
	24.5 710/75	TR218A	180	765	101429		
36	9.5 11.2 12.4 230/95 270/95 320/85	TR218A	65	779	170072	M779	404542
	13.6 340/85	TR218A	80	780	170073		
38	11.2 12.4 270/95 320/85	TR218A	65	779	170072	M779	404542
	13.6 380/95 VF380/95 340/85 380/80 VF380/80	TR218A	90	795	170079	M795	456392
	14.9 16.9 380/85 420/85 480/70	TR218A	95	786	170076	M786	325321
	15.5 380/95 VF380/95 380/80 VF380/80 400/75	TR218A	90	796	118826	M796	044169
	18.4 460/85 520/70 540/65 VF600/60	TR218A	100	824	170151	M824	156066
	20.8 520/85 580/70 620/70 600/65 650/65 IF650/65 VF650/60 IF710/60 VF710/60	TR218A	105	825	170152	M825	701676
	650/85 IF650/85 IF710/85 650/75 IF650/75 IF680/75 710/70 IF800/70	TR218A	105	804	170088	M804	004503
42	16.9 18.4 480/80	TR218A	90	801	170084	M801	333630
	20.8 520/85 VF520/85 580/85 VF650/85 IF710/75 620/70 710/70 IF710/70 650/65 VF650/65 VF710/60	TR218A	140	802	170006	M802	158373

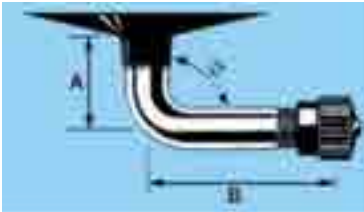

REFERENCIAS DE CÁMARAS DE AIRE INTERNAS Y VÁLVULAS

Apoyo	Dimensiones	Designación de la válvula	Descentrado de la válvula	Categoría KLEBER	CAI KLEBER	Categoría MICHELIN	CAI MICHELIN
44	11.2 270/95	TR218A	80	813	440524		
46	12.4 14.9 300/95 420/85 380/80 VF380/80 420/80	TR218A	80	835	203376	M835	847882
	18.4 20.8 520/85 480/80 VF480/80	TR218A	100	834	467962	M834	072291
48	9.5 11.2 230/95 270/95	TR218A	80	835	203376	M835	847882
50	320/90	TR218A	70	816	170007	M816	762800
52	12.4 300/95	TR218A	70	816	170007	M816	762800
54	11.2 270/95 320/90	TR218A	70	816	170007	M816	762800

DATOS TÉCNICOS DE LAS VÁLVULAS

Dimensiones	Tipo de llanta	Dimensión F en mm
VÁLVULAS DE LA CÁMARA DE AIRE INTERNA		
10 SC29		A = 15 mm B = 29 mm $\alpha = 90^\circ$ \varnothing = Orificio de la válvula = 10 mm
10 SCH40		A = 13 mm B = 27 mm $\alpha = 150^\circ$ \varnothing = Orificio de la válvula = 10,2 mm
TR13 (ETRTO = V2-01-1)		L = 35 mm \varnothing = Orificio de la válvula = 11,5 mm
TR15 (ETRTO = V2-01-2)		L = 35 mm \varnothing = Orificio de la válvula = 16 mm
TR218A (ETRTO = V7-01-1) Válvula de ar/aire		L = 47,5 mm \varnothing = Orificio de la válvula = 15,7 mm

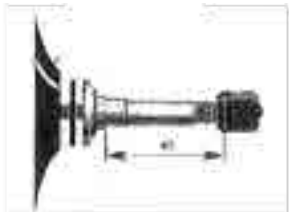
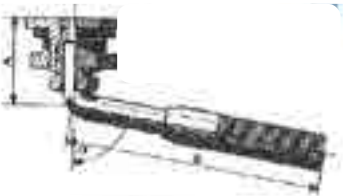
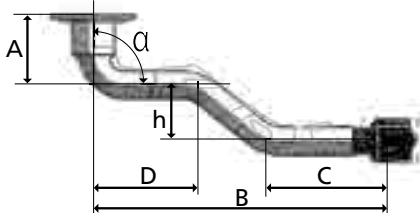
DATOS TÉCNICOS DE LAS VÁLVULAS

Dimensiones	Tipo de llanta	Dimensión F en mm
VÁLVULAS DE LA CÁMARA DE AIRE INTERNA		
1964		L = 40 mm Ø = Orificio de la válvula = 9,7 mm
1837 Equivalencia : • TRA = TRJ650 • ETRTO = V5-04-1		A = 27 mm B = 79 mm $\alpha = 80^\circ$ Ø = Orificio de la válvula = 20,5 mm
582 (ETRTO = V3.06.5)		A = 20,5 mm / B = 131 mm C = 49 mm / D = 62,5 mm $\alpha = 90^\circ$ / h = 17 mm
1123 (ETRTO = V3.06.8)		A = 24,5 mm / B = 126,5 mm C = 50,5 mm / D = 61,5 mm $\alpha = 94^\circ$ / h = 17 mm
VÁLVULAS TUBELESS		
TR618A (ETRO = V5-01-1) Válvula de ar/aire		L = 47,5 mm Ø = Orificio de la válvula = 15,7 mm
INTERIOR DE VÁLVULA DE AIRE/AGUA		



INSTRUCCIONES PARA EL MONTAJE Y DESMONTAJE DE NEUMÁTICOS

Los procedimientos para el montaje y desmontaje de neumáticos pueden implicar ciertos riesgos, por lo que un profesional capacitado y calificado debe llevarlos a cabo haciendo uso de herramientas y métodos apropiados. Nunca se debe confiar esta operación a un aprendiz. Si hay varias personas involucradas en el montaje de neumáticos grandes, asegurarse de que **al menos un miembro del equipo** esté presente **durante todo el procedimiento**. Se debe utilizar un circuito de aire comprimido equipado con un limitador de presión. El incumplimiento de estas instrucciones puede dar lugar al montaje incorrecto del neumático sobre la llanta y causar la explosión del neumático, con el riesgo de producir heridas corporales graves o incluso mortales.

■ DESMONTAJE DEL NEUMÁTICO DEL RIN

1. Nunca despegar del rin o las cejas de un neumático inflado.
2. Es necesario retirar el mecanismo interior de la válvula.
 - Antes de proceder al desmontaje, asegurarse de que el neumático esté completamente desinflado
 - No utilizar herramientas que dañen los flancos o las cejas del neumático
 - Despegar las cejas del neumático con la ayuda de las entradas de desmontaje (si las hay)
 - Para facilitar el desmontaje y proteger las cejas, particularmente en el caso de un pinchazo, lubricar los apoyos de la llanta y las cejas del neumático
 - Si la llanta presenta daños visibles, proceder al desinflado antes del desmontaje de las partes

■ PREPARACIÓN PARA EL MONTAJE

1. Antes del montaje, es necesario asegurarse de la compatibilidad entre la llanta, el neumático y la cámara de aire interna. Verificar que:
 - El neumático sea adecuado para el vehículo o la máquina
 - El diámetro del apoyo de la llanta corresponda al apoyo del neumático que se va a colocar (p. ej.: neumático 18.4 R 30, llanta: DW16L x 30)
 - Esté autorizado el montaje del neumático sobre este tipo de rin (ver las características en la documentación del fabricante)

 **Nunca montar neumáticos de 15" en rines con apoyos de 15.3".
Nunca montar neumáticos de 16" en rines con apoyos de 16.1" o 16.5".**

2. Antes de montar un neumático sobre un rin usado previamente:
 - Asegurarse de que el rin esté **limpia** y en perfectas condiciones (sin presentar ningún deterioro)
 - En caso de suciedad, limpiar correctamente el rin con ayuda de un cepillo metálico

 **Nunca montar un neumático sobre un rin con fisuras, deformaciones considerables, inicios de ruptura, rastros de reparación por soldadura, etc.**

INSTRUCCIONES PARA EL MONTAJE Y DESMONTAJE DE NEUMÁTICOS

3. En el caso de un neumático usado, examinar atentamente tanto el exterior como el interior con el fin de encontrar posibles daños.

- Si presenta un desgaste o deterioro que no puede ser reparado por un especialista, desechar el neumático.

4. Para el montaje de una cámara de aire interna siempre se debe utilizar una cámara nueva que sea apta para las dimensiones del neumático (en las cámaras aparecen las dimensiones de neumáticos compatibles).

⚠ No montar una cámara de aire interna en un rin dañado o reparado, ni en llantas cuyo acabado no sea compatible con la cámara.

Siempre que se reemplace un neumático sin cámara, es necesario montar una válvula Tubeless nueva.

5. Emplear siempre herramientas en buen estado, sin bordes afilados, que estén en buenas condiciones y que sean apropiadas para los neumáticos y los rines (despegatalones, palancas, máquinas...).

En el caso de neumáticos anchos o de gran volumen, aconsejamos el uso de un despegador o despegatalones hidráulico (con la asistencia mecánica adecuada) para el montaje del segundo talón. Antes de proceder al montaje, lubricar los apoyos de la llanta y las cejas del neumático. Aplicar una capa fina de lubricante sobre las superficies indicadas en el siguiente esquema. En el exterior de las cejas, el lubricante debe subir hasta 5 cm más arriba que el borde de la llanta. Utilizar únicamente productos específicos para este fin, que no sean agresivos para el neumático (por ejemplo, no usar productos a base de hidrocarburos, siliconas o anticongelante).

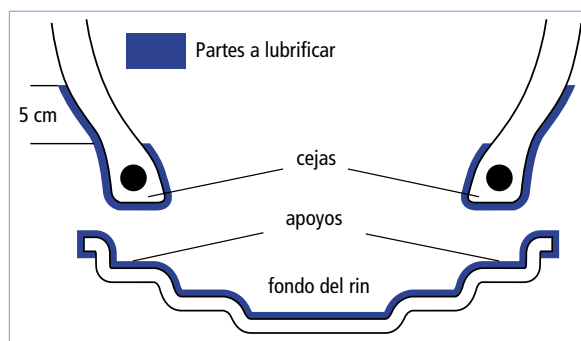

INSTRUCCIONES PARA EL MONTAJE Y DESMONTAJE DE NEUMÁTICOS

■ MONTAJE VERTICAL DEL NEUMÁTICO EN LA RUEDA

1. Colocar la válvula o el orificio de válvula en la parte inferior.
2. En caso de que exista un diagrama de la válvula sobre el flanco del neumático, colocarlo lo más cerca posible de la válvula o el agujero de válvula de la llanta.
3. Colocar el neumático en la llanta de modo que el primer talón se posicione detrás del borde de la llanta. Respetar, si lo hay, el sentido de rotación indicado en el neumático con una flecha.
4. Con la ayuda de una palanca apropiada para aplicar presión aproximadamente cada 10 cm:

- Hacer pasar el primer talón sobre la pestaña de la llanta

Una vez que haya pasado el primer talón:

- Colocar la cámara de aire interna ligeramente inflada dentro del neumático (en el caso del montaje de una cámara de aire interna)
- Fijar la válvula apretando la tuerca ligeramente

Para la segunda ceja:

- Hacer pasar la ceja sobre el borde de la llanta, haciendo palanca
- Terminar en la válvula

5. Centrar el neumático y ajustar las cejas:

- Bajar ligeramente el gato para optimizar el centrado del neumático
- Retirar el mecanismo interior de la válvula
- Inflar lenta y parcialmente para la colocación óptima de las cejas
- Comprobar que las cejas no pellizquen la cámara de aire interna
- Inflar hasta 2.5 Bar, sin superar esta presión, para garantizar un buen posicionamiento de las cejas

■ INFLADO Y COLOCACIÓN DE LAS CEJAS

Aplicar las normas de seguridad:

- Sistema de retención del conjunto neumático (jaula de seguridad)
- Gafas protectoras
- Calzado de seguridad
- Protectores auditivos

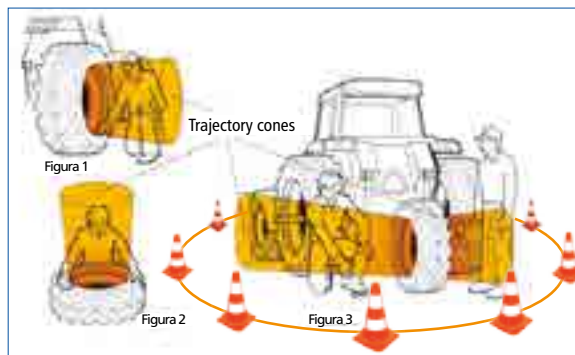

En caso de que no haya una jaula de seguridad, el operador debe alejarse del neumático y del rin tanto como sea posible.

⚠ Nunca pararse en las trayectorias de los conos (figuras 1, 2 y 3) para evitar cualquier daño corporal en caso de un incidente.

Para trabajar en las mejores condiciones de seguridad, utilizar una pistola de inflado conectada a la válvula mediante una alargadera de manguera de aire de 3 metros como mínimo, equipada con un sistema de apertura de aire y un manómetro calibrado (no bloquear nunca el disparador).

Al colocar las cejas, poner especial atención en asegurarse de que estén bien colocados y centrados en relación con las pestañas del rin e inflar hasta 2.5 Bar, sin superar esta presión.

INSTRUCCIONES PARA EL MONTAJE Y DESMONTAJE DE NEUMÁTICOS

Si las cejas no están colocadas correctamente:

- Desinflar, lubricar nuevamente e inflar a 2.5 Bar
- Repetir estas operaciones tantas veces como sea necesario hasta la colocación correcta de las cejas.

Para ajustar y colocar las cejas en los apoyos del rin
INFLAR HASTA 2.5 BAR, SIN SUPERAR ESTA PRESIÓN.

El pictograma adjunto indica la presión máxima de inflado, la cual no debe superarse en el momento de colocar las cejas.

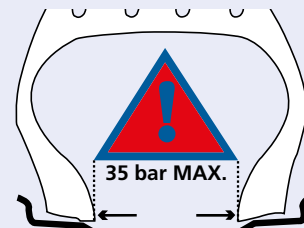

Una vez efectuadas todas las operaciones anteriores:

- Colocar el mecanismo interior de la válvula
- Apretar la tuerca de la válvula con la mano
- Inflar a la presión de servicio determinada, en función de la carga mencionada en la documentación del fabricante o a la presión de almacenaje
- Apretar el tapón de la válvula después del inflado o la revisión de presión; esto garantiza que la válvula permanezca limpia y sellada

En caso de realizar un montaje horizontal sobre el suelo (método que desaconsejamos, ya que es imposible ver si el talón inferior se colocó adecuadamente), tomar las siguientes precauciones adicionales:

- En primer lugar, no superar la presión máxima de 0.7 Bar (para garantizar su estanqueidad)
- Colocar el conjunto del neumático y el rin en una jaula de seguridad o apoyar la parte superior en una pared, nunca en una puerta o muro de tabique ligero
- Seguir las instrucciones de inflado y colocación de las cejas (ver el diagrama de la página 209)

Nota:

Todos los neumáticos radiales que trabajen a presiones bajas se deben montar sobre rines de calidad.

■ PUESTA EN MARCHA/RECOMENDACIONES

- Para el transporte de la maquinaria (por carretera, en tren o en barco), recomendamos inflar los neumáticos a 1.8 Bar (26 Psi) con el fin de evitar posibles deterioros a causa de algunos sistemas de amarre.
- Al poner la maquinaria en marcha, las presiones deben regularse en función de la carga y las condiciones de uso.

INSTRUCCIONES DE USO presión correcta

✓ **Comodidad** ✓ **Adherencia** ✓ **Protección a los suelos**
=
✓ **Duración de los neumáticos** ✓ **Rendimiento óptimo de la máquina**

INSTRUCCIONES PARA EL MONTAJE Y DESMONTAJE DE NEUMÁTICOS

■ LASTRADO

• Lastrado de los neumáticos con un líquido

En casos particulares, una solución para aumentar la adherencia o reducir el centro de gravedad de la máquina en los neumáticos Tubeless (sin cámara de aire) y en los neumáticos Tube Type (con cámara de aire) es el lastrado de los neumáticos con líquido.

Las válvulas agrícolas son de tipo "aire y agua", lo cual significa que se pueden rellenar con líquido (agua + anticongelante) a un volumen máximo de 75% (diagrama 1).

En invierno, las temperaturas pueden ser inferiores a 0°C, por lo que se requiere el uso de un producto anticongelante a base de glicol.

Llenar con líquido la cámara de aire interna o el neumático Tubeless al nivel de la válvula (la válvula en el punto más alto) y sacar el aire de forma simultánea (diagrama 2).

El inflado y la presión se ajustan con aire.

Como el volumen de aire que suministra la presión es bajo (aproximadamente de 25%), es importante revisar con regularidad la presión; MICHELIN® recomienda hacerlo mensualmente.

• En caso de lastrado líquido en neumáticos Tubeless

- Desinflar el neumático a una presión baja (alrededor de 0.5 Bar)
- Colocar la válvula en el punto más alto
- Proceder a lastrar el neumático con líquido (agua + anticongelante) a un máximo del 75% y sacar el aire de forma simultánea (diagrama 2)
- Terminar de inflar con aire y ajustar a la presión

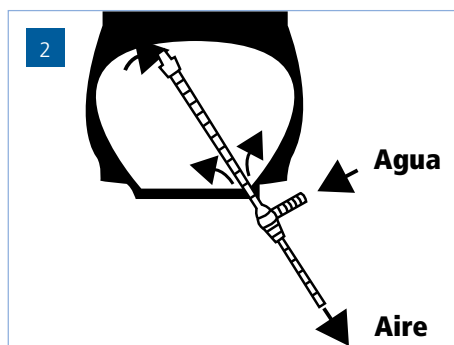
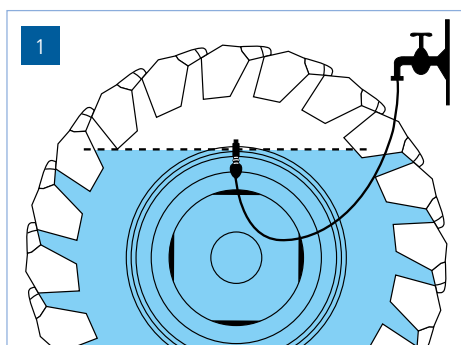

INSTRUCCIONES PARA EL MONTAJE Y DESMONTAJE DE NEUMÁTICOS

■ ALMACENAMIENTO

Para un buen almacenamiento, los neumáticos deben conservarse en condiciones limpias, en un establecimiento seco y ventilado, protegidos de la luz directa del sol y alejados de:

- Cualquier fuente de ozono (motor eléctrico, transformador, estación de soldadura en arco, etc.)
- Cualquier sustancia química, solventes e hidrocarburos que puedan alterar la naturaleza del caucho
- Cualquier objeto que pueda penetrar el caucho (objetos metálicos puntiagudos o filosos, etc.)

Mantenerlos lejos del fuego o de cuerpos incandescentes.

Durante los periodos de almacenamiento, los neumáticos y las cámaras de aire internas agrícolas deben conservarse de manera que no sufran deformaciones debido a la tensión o el aplastamiento, así como montados e inflados si se encuentran apilados; aligerar los neumáticos montados en un vehículo en la mayor medida posible y sobreinflar a 0.5 Bar con relación a la presión de uso.

 **Nunca almacenar los rines descubiertos o los conjuntos desmontados del vehículo en contacto directo con el suelo durante periodos largos.**

Se recomienda el uso de guantes de protección para la manipulación de los neumáticos.

 **Nunca calentar, soldar por combustión ni soldar un rin o rueda con el neumático montado. Siempre se debe desmontar el neumático del rin antes de cualquier intervención.**

 **Siempre utilizar la tabla de inflado de MICHELIN® para definir la presión correcta para cada uso previsto.**

 **Una presión insuficiente causa una deformación excesiva del casco y hace que la llanta se vuelva inservible.**

 **Una presión excesiva disminuye la superficie de contacto con el suelo, provoca una pérdida de adherencia y hace que la cubierta sea más sensible a los choques y a los cortes.**

 **Aunque las cargas sean inferiores a las indicadas por MICHELIN® en las tablas carga/presión, no usar nunca una presión inferior a la mínima indicada en las tablas.**



USO DE LOS NEUMÁTICOS AGRÍCOLAS / 2019



Video tutorial

Montaje y desmontaje de un neumático



<https://www.youtube.com/watch?v=cdnfh0o9Yhl>

AGRO.MICHELIN.COM



MICHELIN

NOTAS

Area for notes with horizontal dotted lines.



AGRÍCOLA **DOCUMENTACIÓN** **TÉCNICA DE NEUMÁTICOS**

2020

Asociación con Manufacture Française des Pneumatiques Michelin
limitada por acciones con un capital de 504 000 004 €

Oficina registrada:
Place des Carmes Déchaux - 63040 Clermont-Fd cedex 9
Tel.: + 33(0)4 73 32 20 00 - Fax: + 33 (0)4 73 32 22 02

www.michelin.fr
855 200 507 RCS Clermont-Ferrand

JULIO 2020

 AGRO.MICHELIN.COM

 [MICHELIN AGRICULTURE](#)

