

2021 EDITION MICHELIN EARTHMOVER

USE AND MAINTENANCE GUIDE



MICHELIN

EARTHMOVER & INDUSTRIAL, PORT AND INTERMODAL TIRES

The information provided herein is exclusively for MICHELIN® Earthmover & Industrial, Port and Intermodal tires. It is for informational purposes only and may not be used or relied upon for legal or statutory action or should be construed to otherwise modify any existing contract with you. For technical and safety reasons, a tire should never be used beyond the limits of the technical specifications for which it has been approved and all relevant recommendations as provided herein should be followed.

MICHELIN® tires are designed for a specific use as defined in the Michelin Technical Data book. Any other use constitutes an abnormal use. However, in some circumstances, Michelin may issue a waiver which will specify the conditions and the permitted operational limits for a specific application. If a tire is to be used differently than what it is designed for, please consult your nearest Michelin Representative for further guidance. Michelin expressly denies any responsibility for any abnormal use of its tires or any use different from the tire's intended design in the absence of express written permission (derogation) from an authorized Michelin Representative.

Further, correct usage and maintenance are necessary to achieve proper performance and to maximize life. Therefore, it is recommended that users adhere to all safety and usage recommendations. However, you must note that these recommendations may be subject to more restrictive local legal and/or regulatory requirements. The compliance with such regulations is the users' responsibility.

Finally, unless otherwise specified, MICHELIN® off-the-road, industrial, and compact tires comply with internationally accepted standards that are established by TRA (Tire and Rim Association), ETRTO (European Tire and Rim Technical Organisation), JATMA (Japan Automobile Tire Manufacturers Association), and/or ISO (International Standards Organisation). Among other things, the standards encompass load capacity, inflation pressure, overall diameter, overall width, and related valves and rims. Some minor differences may exist between these standards.

SPECIFIC APPLICATIONS

Please note that tires for mechanical handling equipment used in areas where there is a high risk of fire or explosion, such as the chemical and petrochemical industries, must meet certain standards concerning their electrical resistivity. When the electrical resistance measured according to ISO 16292 or WDK 110 standards is lower than 106 Ohms, then the tire is called 'dissipative' and its sidewall features the following symbol.



PERFORMANCE

Any and all tire performance claims or comparisons contained herein are for informational purposes only to aid in the selection of a tire and **do not** constitute any form of performance guarantee or warranty. Individual results may vary. Such information may not be used as a basis for any performance guarantee or warranty claim.

Following publication, the information herein is subject to change at Michelin's sole discretion.

Throughout the world, whatever types of machine are used (from forklift trucks to trucks weighing more than 600 tons), our customers all have the same ongoing concerns:

- to increase their productivity and reduce their operating costs while ensuring optimum protection of the environment;
- to maintain, and even improve, the safety level of sites—first and foremost for people, but also for equipment.

Tires have a major influence on these issues. Their impact on the operating costs and productivity of machines is widely analyzed. However, there is still not enough known about the specific problems involved with using tires and the expertise needed to ensure customers get the best out of their tires while protecting the environment.

What precautions should be taken and what tools should be used when mounting tires that sometimes weigh several tons and are inflated to high pressures? What are the possibilities for repairing these pieces of equipment? How should the place where they are maintained be physically organized? What are the recommendations for making your selection from the huge number of products and accessories that are available on the market?

Michelin has devised and is distributing this Use and Maintenance Guide to provide answers to these and many other questions.

In it, you will find all the recommended practices for correct use and effective monitoring of your tires. They will help you maximize the potential of your tires in a safe manner. Safety is covered in every chapter by providing recommendations to mitigate associated risks. This guide is written for you, so please do not hesitate to let us know your suggestions for improvements and additional information that should be included.

Thanks to the high quality of its products and the excellence of its teams, **Michelin** is recognized worldwide as providing the users of earthmover tires with the best offer in terms of tire productivity.

This is why, in line with its values of respect for people, the environment and its customers, **Michelin** wants to share the benefits of the experience it has acquired over the years, which is constantly being updated as its products change and the earthmover industry advances.

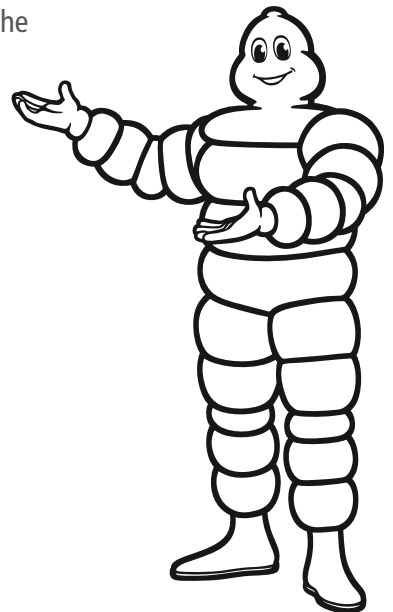

CONTENTS

1	INTRODUCTION TO SAFETY	1
	INTRODUCTION	2
	FOLLOW INSTRUCTIONS!.....	3
	QUESTIONS YOU SHOULD ALWAYS ASK YOURSELF.....	4
	BEFORE YOU DO ANYTHING - FIND OUT ABOUT IT!.....	5
	CAUTION, DANGEROUS SITUATIONS!.....	8
2	GENERAL INFORMATION ON MICHELIN® EARTHMOVER TIRES	9
	INTRODUCTION	10
	COMPARING TIRE CONSTRUCTION.....	11
	CLASSIFICATION OF TIRES	13
	TIRE MARKINGS.....	15
3	HANDLING AND STORING TIRES	19
	INTRODUCTION	20
	HANDLING TIRES: ESSENTIAL PRECAUTIONS TO ENSURE THE INTEGRITY OF TIRES.....	21
	STORING TIRES: ESSENTIAL PRECAUTIONS TO PROTECT TIRES.....	23
4	TIRE FIRES AND THEIR PREVENTION	27
	INTRODUCTION	28
	TYPES OF FIRE TO WHICH A TIRE MAY BE SUBJECTED	29
	IGNITION OF AN UNMOUNTED TIRE.....	30
	PUTTING OUT A TIRE FIRE.....	31
	PREVENTION AND TRAINING	32
	HOW TO REDUCE THE RISKS OF TIRE FIRES DURING OPERATION	33
5	TIRE MAINTENANCE WORKSHOP	35
	INTRODUCTION	36
	ORGANIZATION OF THE WORKSHOP.....	37
	SAFETY INFORMATION	38
6	MOUNTING AND DEMOUNTING	39
	INTRODUCTION	40
	GENERAL PRECAUTIONS AND OPERATOR SAFETY	41
	MOUNTING OPERATIONS.....	43
	DEMOUNTING OPERATIONS.....	45
	STEPS IN THE MOUNTING AND DEMOUNTING PROCESSES	46
7	DUALS USAGE	47
	INTRODUCTION	48
	RULES FOR DUAL TIRE USAGE: MOUNT TIRES THAT ARE AS SIMILAR AS POSSIBLE.....	49
	CONDITIONS FOR DUAL TIRE USAGE: STRICT COMPLIANCE WITH THE RECOMMENDATIONS	49
	REGULAR INSPECTION OF DUAL TIRE.....	50
	FITMENTS IS ESSENTIAL!.....	50
	HOW TO LIMIT UNEVEN WEAR	51
	SPECIFIC PROCEDURES FOR DEMOUNTING DUAL TIRES	52
8	INFLATION AND CHECKING TIRE PRESSURES	53
	INTRODUCTION	54
	INFLATION PRESSURE: AN ESSENTIAL PARAMETER	55
	OPTIMIZE THE PRESSURE ACCORDING TO THE OPERATING.....	57
	INFLATION: AIR OR NITROGEN?	60
	INFLATION ADDITIVES	62
9	INSERTS AND SOLID FILLS	63
	INTRODUCTION	64
	GENERAL USAGE CHARACTERISTICS	65
	RUBBER INSERTS	65
	SOLID POLYURETHANE ELASTOMER FILLS	66
	SOLID FILLS AND INSERTS: ADVANTAGES AND DISADVANTAGES.....	67
	MICHELIN'S POSITION ON THE USE OF SOLID FILLS OR INSERTS IN MICHELIN® TIRES.....	68

10 FACTORS INFLUENCING THE SERVICE LIFE OF TIRES 69

INTRODUCTION 70
CHOOSING A TIRE INVOLVES MAKING A DECISION BASED
ON EXPECTED PERFORMANCE AND ACTUAL CONDITIONS OF USE..... 71
MAIN CAUSES OF TIRE DAMAGE..... 72
INTERNAL OPERATING TEMPERATURE 74
INFLUENCE OF THE VEHICLE ON THE SERVICE LIFE OF ITS TIRES..... 76
INFLUENCE OF THE SITE ROADS, KEY FACTORS FOR TIRE SERVICE LIFE ... 79
FACTORS INFLUENCING THE SERVICE LIFE OF TIRES..... 80

11 MACHINE INSPECTION 81

INTRODUCTION 82
ALIGNMENT..... 83
SUSPENSION 84

12 INSPECTING TIRES ON VEHICLES 89

INTRODUCTION 90
PRELIMINARY PRECAUTIONS..... 91
PROCEDURE 92
POINTS TO CHECK 94

13 INSPECTING DEMOUNTED TIRES 97

INTRODUCTION 98
FULL ASSESSMENT AND ACTION TO BE TAKEN..... 99
TIRE INSPECTION TOOLS AND PROCEDURE 100

14 REPAIRING TIRES 103

INTRODUCTION 104
ORGANIZATION OF THE REPAIR WORKSHOP..... 105
REPAIR METHODS 106

15 REGROOVING 111

INTRODUCTION 112
REGROOVING AND SIPING..... 113
GENERAL PRINCIPLES 114
REGROOVING AND SIPING GUIDELINES..... 115

16 RETREADING TIRES 119

INTRODUCTION 120
RETREADING, A COMPLEX INDUSTRIAL PROCESS 121
ORGANIZATION OF THE WORKSHOP..... 121
UNCURED RUBBER OR PRE-MOLDED TREADS...
THE DIFFERENCE IS IN THE BUILDING AND CURING! 122
RETREADABILITY CONDITIONS 123
CURING, AN IMPORTANT STAGE IN RETREADING..... 124
PERFORMANCE AND ECONOMIC BENEFIT 125
STAGES IN THE RETREADING PROCESS..... 126

17 REMOVAL RECOVERY DUE TO WEAR/USED TIRES 129

INTRODUCTION 130
REMOVAL DUE TO WEAR AND RECOVERY OF USED TIRES 131

18 MACHINES AND THEIR USES 133

MACHINE CONFIGURATIONS..... 135
MACHINES FOR OPEN-PIT MINES AND QUARRIES 136
MACHINES FOR EARTHWORKS AND INFRASTRUCTURE SITES..... 139
MACHINES SPECIFICALLY FOR ROAD CONSTRUCTION..... 144
MOBILE CRANES..... 146
MACHINES FOR UNDERGROUND MINES 148
HANDLING MACHINES 150
SPECIAL MACHINES..... 157

19 GLOSSARY 159

20 NOTES 165

INTRODUCTION TO SAFETY

1

2 *INTRODUCTION*

3 *FOLLOW INSTRUCTIONS!*

4 *QUESTIONS YOU SHOULD ALWAYS
ASK YOURSELF*

5 *BEFORE YOU DO ANYTHING—
FIND OUT ABOUT IT!*

8 *CAUTION, DANGEROUS SITUATIONS!*



SAFETY

a frame of mind, a constant and very important concern.

Safety is paramount!
And this is why we want to make readers aware of the risks connected with working with earthmover tires.

This chapter is devoted entirely to safety and is designed to be used as a handy reference.

Safety must become a frame of mind, wherever you are—in storage areas, on work sites, at ports, in quarries or in mines.

The safety rules apply for work around all tires, whatever their size.

These rules must always go hand in hand with compliance with national regulations.



An exploding tire can cause physical, occasionally even fatal, injuries up to several dozen meters away from the explosion point!

The example of the mining tire, which can be more than 4.4 yards (4 mètres) high and weigh over 5.5 U.S. tons (5 tonnes), with an internal volume close to 2,600 u.s. gal (10.000 litres), illustrates the magnitude of the potential danger.

Follow instructions!

There are instructions everywhere, and you must find out what they are before carrying out any work. Specific safety recommendations are given in each chapter of this Use and Maintenance Guide.



Identification is mandatory before entering any site

Go to the entrance of the site and acquaint yourself with the safety instructions



Pay attention to the information signs about mine blasting



Examples of personal protection equipment

Make your presence known

Entry to a site is generally controlled. You often need:

- prior authorization;
- ID badge.

Always find out what you need to know

Knowledge of the current rules is essential to:

- make a point of reading the instructions for driving and working on-site;
- make sure you know about any specific safety rules (for example, blasting times and locations).

Caution: These rules may be modified if the operating conditions change.

Wear the right equipment



Immobilization lock

It is strongly advisable to wear a hard hat, protective glasses, safety shoes, gloves and a high-visibility vest (or reflective jacket).

The use of such equipment is generally detailed in the internal regulations of the site.

A vehicle immobilization lock may be necessary to render equipment inoperative when you want to examine the tires.

This procedure is often used in larger-size quarries and routinely used in mines.

Questions you should always ask yourself



Sloped work area...danger!

- > Is the situation dangerous?
- > Is the use of the equipment potentially dangerous?
- > What actions are dangerous or even prohibited?
- > Are the working procedures known?

To keep safety at the forefront of your mind on a site using earthmover tires, you must constantly answer the following questions:

Is the situation dangerous?

Does it involve risks of falling, tipping over or crushing, etc?
How can these risks be prevented?

Are the areas clean and tidy?

Untidiness and dirtiness increase the risk of accidents. Floors that are slippery or cluttered with tools or equipment increase the likelihood of falls.

Is the use of the equipment potentially dangerous?

The operation of some machines is hazardous.
Are the operators qualified to use them?
Do the machines emit warning signals when moving?

Example: Handling equipment is required for mounting tires. Are the areas in which they move unobstructed? Do they emit warning signals when moving?



Clean the work area

What actions are dangerous or even prohibited?

Are the work methods dangerous?
What actions present a risk?



Example of an operation that is strictly prohibited:
Carrying out welding on a wheel without demounting the tire!

Are the working procedures known?

Working safely around tires requires compliance with clearly defined procedures.

Example: mounting and demounting, inflation, etc.



Unobstructed areas are required for handling equipment

Before you do anything— find out about it!

Before doing anything on a work site, a mine or any other site, it is essential to know the answers to the following questions. In most cases, the answers are provided when information is given prior to authorization to drive on-site. Some mines require a security training of several days.

Which safety rules are applicable to the site?

See also the chapter entitled "General information on Earthmover tires," which covers this subject. If there are no rules (this is rare), comply with those given in this chapter.

What are the rules regarding driving on-site?

Does the vehicle used need to have mandatory equipment fitted in order to drive on-site?

What are the rules regarding signaling (priority, overtaking, speed limits, etc.)?

What are the hazardous situations?

Are there places where it is temporarily or permanently dangerous to drive (tracks undergoing maintenance, movement of heavy equipment, etc.)?



Always drive with your headlights on in a mine or quarry



Mine blasting

What is the timetable for mine blasting?

Blasting is carried out regularly at set dates and times.



Pay attention to the signs

On arrival at a mine or quarry, always find out about the preliminary alert and evacuation procedures for the blasting area.

Under what conditions can you approach vehicles?

All equipment presents risks, which increase as the size of the equipment increases.

The immediate area around a vehicle is always dangerous:

- driver's visibility is limited in the area close to their equipment: the larger the equipment, then the larger this area;
- for loaded transport equipment, there is a risk of material falling from the dump body at any time and, in particular, when starting.



The immediate area around equipment is dangerous



When you have to approach a vehicle:

- ***ask the driver for authorization to do so and wait for confirmation;***
- ***keep to the safe areas;***
- ***indicate your movements.***



Caution, dangerous situations!



SPOT THE DANGEROUS SITUATIONS

- 1 In front of a tire that is falling over.
- 2 Facing the sidewall during inflation.
- 3 Tools scattered over the work area.
- 4 Risk of material falling off when the truck starts.
- 5 Operator off-balance, risk of falling.
- 6 Risk of material falling off during transport.

GENERAL INFORMATION ON EARTHMOVER TIRES

10 INTRODUCTION

11 COMPARING TIRE CONSTRUCTION

13 CLASSIFICATION OF TIRES

15 TIRE MARKINGS



MICHELIN[®] EARTHMOVER TIRES

high-tech products

Machines that use earthmover tires are involved in most economic activities.

The machines are frequently used in difficult or even extreme conditions. Mines, ports, infrastructures, industry—these are all demanding environments which can really put tires to the test!

In response, Michelin is committed to developing ranges of tires that are suitable for each type of machine and use.

These tires are continuously being updated to take into account developments in machines and their uses. Reading the markings on the sidewalls of tires (all brands) gives you full information about them (construction, size, use, load index, speed symbol, etc.).

Comparing tire construction

The solid tire

Composition

Several types of rubber with different properties are layered one on top of the other to provide adhesion and traction. So these are not really “pneumatic” tires as they do not contain any air!

Specific use

Mainly used for forklift trucks.

Limitations when used intensively

Significant buildup of heat in the rubber, risk of damage when driven over obstacles. The solid tire may then “break.”



Solid tire

The conventional or “bias-ply” tire

Composition

- This is made of nylon or rayon fabric plies criss-crossed over one another and bonded together with rubber to form a diagonal structure.
- The higher the required load capacity, the greater the number of plies.

Limitations when used

- Friction between the plies leads to a buildup of heat which can adversely affect the tire’s performance. The strong link between the sidewalls and the crown causes the contact patch to be deformed, resulting in poorer adhesion and accelerated wear.
- The tread of a conventional tire is sensitive to punctures.



Conventional tire

The Radial tire: numerous advantages

Composition

This combines metal (or fabric plies) extending from one bead to the other, with a belt made of several steel plies designed to reinforce the crown of the tire.

A unique construction with numerous advantages

- The sidewalls and crown work independently:
 - minimizes the deformation of the contact patch and the weight of the tire;
 - improves adhesion and traction while slowing down the rate of wear;
 - the metal casing increases the load capacity as it can take higher inflation pressures.
- The flexibility of the sidewalls of a Radial tire therefore provides greater comfort.
- The radial band provides better resistance to damage and punctures.

Tire performance levels that transform machine performance

Michelin invented the radial design and is an expert in this field. Radial tires significantly improve the productivity of earthmover machines. Productivity requires a constant trade-off between the following factors: load, speed, operational efficiency of the machines, tire service life, operator safety, etc.

Companies which try MICHELIN® Radial tires very rarely go back to conventional tires, because it is so difficult to give up these advantages.



Radial construction separates the work of the crown from that of the sidewalls



Using a Radial tire also improves fuel economy and reduces the environmental footprint.



The tubeless tire: remarkable properties

Composition

The tubeless Radial tire is mounted with no inner tube, with a special rim equipped with an appropriate valve. From the outside, this tire looks the same as a tube-type tire, and its radial construction is identical.

A layer of special rubber (butyl) is incorporated inside the tire to make it airtight. In certain cases, to be determined with your Michelin Representative, a tubeless tire can be mounted with a tube on a tube-type rim.

Numerous advantages

- Reduced chance of sudden deflations: slow deflation gives the driver time to get to the maintenance workshop for repair
- Easier to mount (no inner tube)
- Lighter weight rim + tire assembly

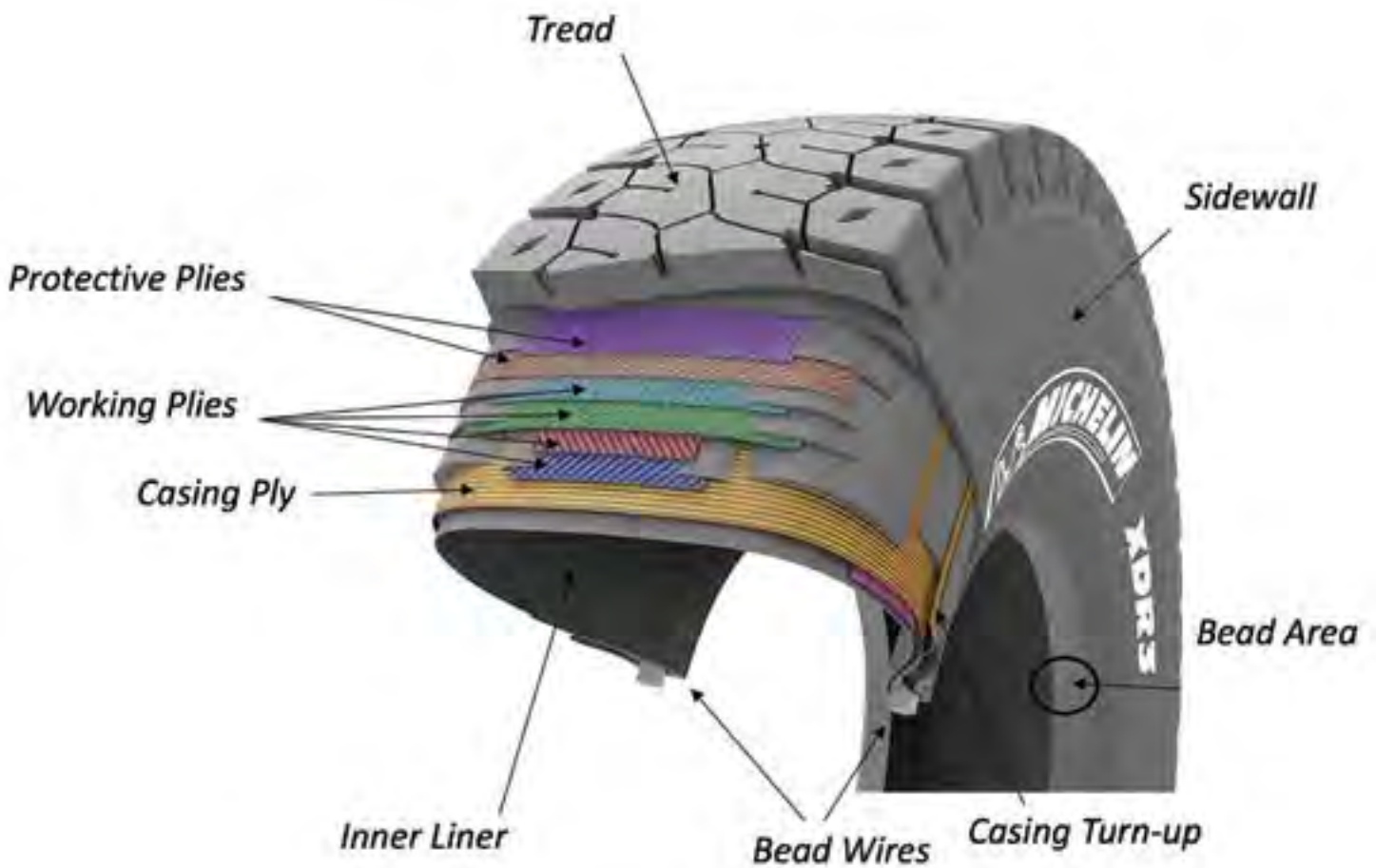

Classification of tires

According to their aspect ratio

The wide diversity of earthmover machines and their uses requires the development of numerous ranges of tires.

Earthmover tires differ from those mounted on cars or commercial vehicles by:

- their size and weight;
- their tread depths are proportionally greater;
- more reinforcements to deal with the harsher conditions of use.

There are several families of earthmover tires, characterized by their aspect ratio H/S (ratio between the height of the sidewall H and the section width of the tire S).

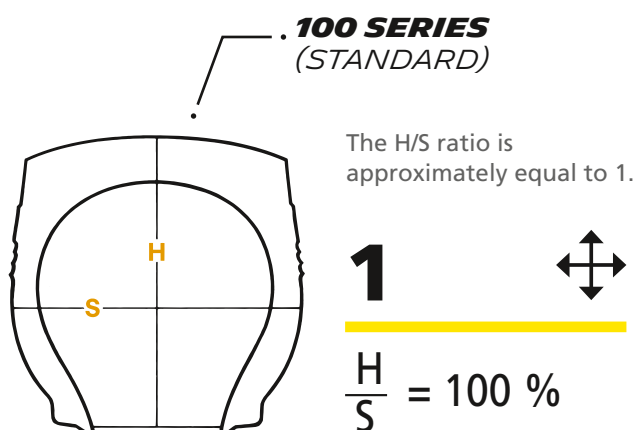

The section width is expressed in inches and hundredth of inches.

Examples: 5.00 R 8, 18.00 R 33

Tires for rigid trucks, handling equipment, etc.

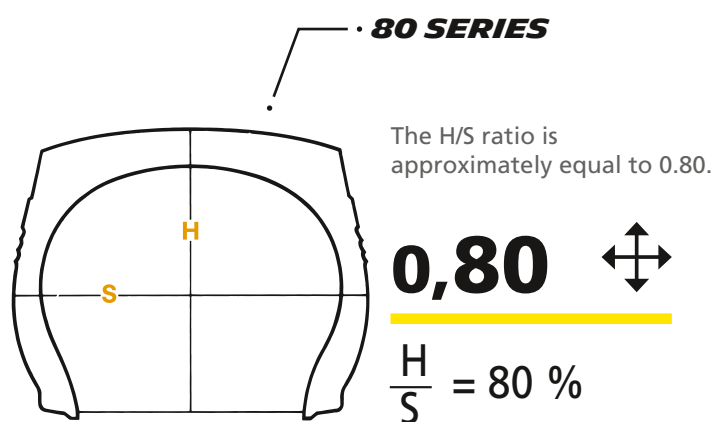

The section width is expressed in:

- Inches and fractions of inches

Examples: 8.25 R 15, 20.5 R 25

- Whole number of inches, followed by the number 80

Example: 59/80 R 63

Tires for rigid trucks, articulated dumpers, loaders, handling equipment, etc.

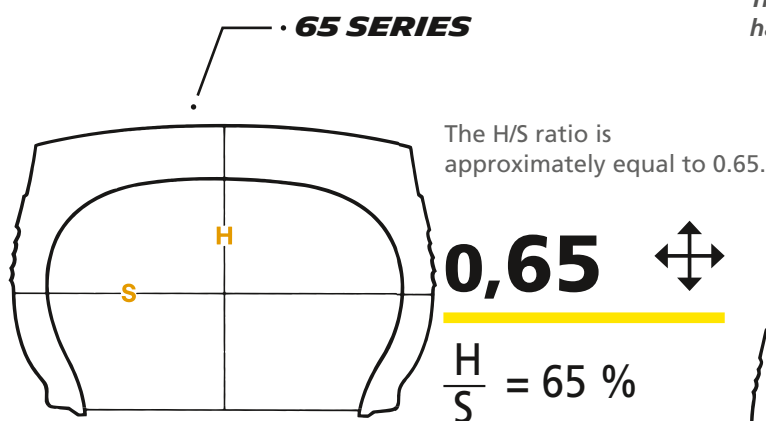

The section width is expressed as a whole number of inches or a whole number of millimeters, followed by the number 65.

Examples: 35/65 R 33, 750/65 R 25

Tires for large loaders, articulated trucks, etc.

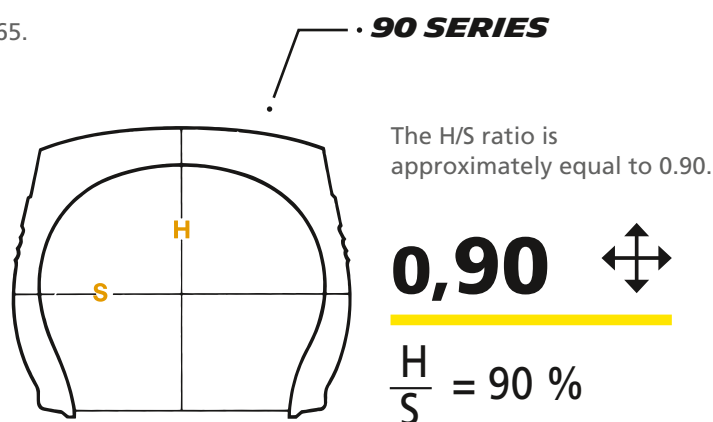

The section width is expressed as a whole number of inches followed by the number 90.

Example: 50/90 R 57

Tires for rigid trucks

Other series of tires are also available: 95 series, 75 series, etc.

According to the standardized usage codes (ISO-ETRTO-TRA-JATMA)#

The four main categories of earthmover tire are defined by their use. The category to which it belongs is indicated on the sidewall of the tire.

This is an international classification:

- C** Compactor
- G** Grader
- E** Earthmoving
- L** Loader and bulldozer

| ISO : International Standard Organisation
ETRTO : European Tire and Rim Technical Organisation
TRA : Tire and Rim Association
JATMA : Japan Automobile Tire Manufacturers Association

As well as the load capacity, this letter indicates the conditions of use and, in particular, the cyclical aspect of the load/speed conditions.

Thus for letter E, Transport, the machine transports a load from point A to point B and returns empty to point A.



Self-propelled crane fitted with MICHELIN® X-CRANE tire

Choosing the tread pattern of a tire according to the intended conditions of use

Within these categories, there are different tread depths and special tread patterns for very specific uses. These are identified by a number.

They must be chosen according to the expected type of ground and the tire's probable conditions of use.

The letter "S" indicates a smooth tread.

Example: L-5S.

- 1** Ribbed (normal tread depth)
- 2** Traction (normal tread depth)
- 3** Normal (normal tread depth)
- 4** Deep (deep tread)
- 5** Very deep (very deep tread)
- 7** Flotation (normal tread)

Tire markings

Load index and speed symbol

The same tire size may be used on different machines which require load capacities and speed symbols directly associated with their specific uses.

This is why tires have information on their load capacity and speed symbol on their sidewalls:

- either a load index/speed symbol;
- or one or more stars;
- or both types of marking together.

For a category of use, the number of stars corresponds to a standardized load capacity. The greater the number of stars, the higher the load capacity.

For a given size, the load capacity is given by combining the number of stars with the letter indicating the use (C, E, L, G).

Examples:

- 26.5 R 25 L3 * = load capacity: 33,070 lb (15.000 kg) – low speed loader type use.

- 26.5 R 25 L3 ** = load capacity: 40,786 lb (18.500 kg) – low speed loader type use.

● Special case of bias tires

For these tires, the information on the load capacity is given by the letters PR followed by a number:

- PR means Ply Rating;
- The number refers to the number of fabric plies incorporated in the construction of the tire. Increasing the number of plies enables the tire to be inflated to a higher pressure and thus gives it a higher load capacity.

If a bias tire is replaced by a Radial tire, the choice can be made:

- either by referring to the characteristics of the machine;
- or based on the PR number marked on the sidewall of the diagonal tire. Michelin technicians can help you interpret the compatibility tables that are available.

● Other possible markings

Tires approved in accordance with current regulations can also have additional markings.

Example: R54 or DOT marking



X-Crane marking

● Bead area (wheel attachment) architectures

The majority of earthmover tires belong to the "5-degree drop center" family of tires.

The rim diameter is given as a whole number.

Examples: 23.5 R 25, 27.00 R 49, etc.



5° rim

Some tires are similar to truck tires and belong to the "15-degree tapered seat" family of tires.

The rim diameter is given as half of a decimal number.

Example : 310/80 R 22.5

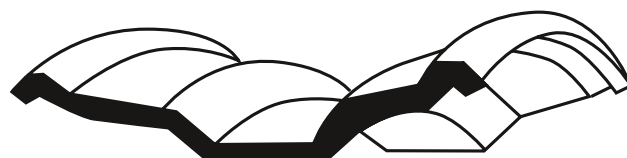

15° rim

Load index (LI) and speed symbol (SS) tables

The load index (LI) is a numerical code associated with the maximum load that a tire can carry at the speed indicated by its speed symbol, under specified conditions of use.

LI	MAXIMUM LOAD		LI	MAXIMUM LOAD		LI	MAXIMUM LOAD		LI	MAXIMUM LOAD		LI	MAXIMUM LOAD	
	KG	LB		KG	LB		KG	LB		KG	LB		KG	LB
120	1 400	3 090	150	3 350	7 390	180	8 000	17 640	210	19 000	41 890	240	45 000	99 210
121	1 450	3 200	151	3 450	7 610	181	8 250	18 190	211	19 500	43 000	241	46 250	101 960
122	1 500	3 310	152	3 550	7 830	182	8 500	18 740	212	20 000	44 100	242	47 500	104 720
123	1 550	3 420	153	3 650	8 050	183	8 750	19 290	213	20 600	45 420	243	48 750	107 470
124	1 600	3 530	154	3 750	8 270	184	9 000	19 840	214	21 200	46 750	244	50 000	110 250
125	1 650	3 640	155	3 875	8 540	185	9 250	20 390	215	21 800	48 070	245	51 500	113 540
126	1 700	3 750	156	4 000	8 820	186	9 500	20 940	216	22 400	49 390	246	53 000	117 950
127	1 750	3 860	157	4 125	9 090	187	9 750	21 500	217	23 000	50 700	247	54 500	120 150
128	1 800	3 970	158	4 250	9 370	188	10 000	22 050	218	23 600	52 040	248	56 000	123 480
129	1 850	4 080	159	4 375	9 650	189	10 300	22 710	219	24 300	53 580	249	58 000	127 890
130	1 900	4 190	160	4 500	9 920	190	10 600	23 370	220	25 000	55 120	250	60 000	132 300
131	1 950	4 300	161	4 625	10 200	191	10 900	24 030	221	25 750	56 780	251	61 500	135 580
132	2 000	4 410	162	4 750	10 470	192	11 200	24 690	222	26 500	58 430	252	63 000	138 890
133	2 060	4 540	163	4 875	10 750	193	11 500	25 360	223	27 250	60 070	253	65 000	143 300
134	2 120	4 670	164	5 000	11 020	194	11 800	26 020	224	28 000	61 740	254	67 000	147 710
135	2 180	4 810	165	5 150	11 350	195	12 150	26 790	225	29 000	63 940	255	69 000	152 120
136	2 240	4 940	166	5 300	11 690	196	12 500	27 560	226	30 000	66 150	256	71 000	156 530
137	2 300	5 070	167	5 450	12 020	197	12 850	28 330	227	30 750	67 790	257	73 000	160 930
138	2 360	5 200	168	5 600	12 350	198	13 200	29 100	228	31 500	69 460	258	75 000	165 340
139	2 430	5 360	169	5 800	12 790	199	13 600	29 990	229	32 500	71 660	259	77 500	170 660
140	2 500	5 510	170	6 000	13 230	200	14 000	30 870	230	33 500	73 870	260	80 000	176 400
141	2 575	5 680	171	6 150	13 560	201	14 500	31 970	231	34 500	76 070	261	82 500	181 880
142	2 650	5 840	172	6 300	13 890	202	15 000	33 070	232	35 500	78 280	262	85 000	187 390
143	2 725	6 010	173	6 500	14 330	203	15 500	34 180	233	36 500	80 480	263	87 500	192 900
144	2 800	6 170	174	6 700	14 770	204	16 000	35 280	234	37 500	82 690	264	90 000	198 450
145	2 900	6 390	175	6 900	15 210	205	16 500	36 380	235	38 750	85 430	265	92 500	203 920
146	3 000	6 610	176	7 100	15 650	206	17 000	37 480	236	40 000	88 200	266	95 000	209 440
147	3 075	6 780	177	7 300	16 090	207	17 500	38 590	237	41 250	90 940	267	97 500	214 950
148	3 150	6 950	178	7 500	16 530	208	18 000	39 690	238	42 500	93 710	268	100 000	220 500
149	3 250	7 170	179	7 750	17 090	209	18 500	40 790	239	43 750	96 470	269	103 000	227 370

(LI: Load Index)

The speed symbol indicates the maximum speed at which a tire can carry a load corresponding to its load index.

CODE	A2	A3	A4	A5	A6	A8	B	C	D	E	F	G
speed (km/h)	10	15	20	25	30	40	50	60	65	70	80	90
speed (mph)	6	9	12	15	19	25	31	37	40	43	50	56

● Example of LI/SS^(#) markings

445/95 R 25 TL 174F

Maximum load 14,771 lb (174) for a speed of 50 mph (F), (6.700 kg (174) for 80 km/h (F)).

This load can be constant for the whole of the time the tire is in use.

23.5 R 25 TL 185B CYCLIC

Maximum load 20,390 lb (185) for a speed of 31 mph (B), (9.250 kg (185) for 50 km/h (B)).

The term CYCLIC indicates that the tires must be used with a load similar or equal to the load corresponding to the load index for half of the cycle and with a much lower load for the other half.

LI: Load Index, SS: Speed Symbol



Read the sidewall of a tire to find out everything about it!



35/65 R33 **MICHELIN®**
X MINE® D2
TIRE

- 1 Nominal section width of the tire (in inches): 35
- 2 Tire series: aspect ratio = 0.65
- 3 Radial construction: R
- 4 Recommended wheel diameter (in inches): 33
- 5 Load index of the tire: **
- 6 Type of use: loader (L) with deep tread (5)
- 7 Radial tire
- 8 Tire for loader
- 9 Tubeless tire
- 10 Manufacturer: MICHELIN
- 11 Tread pattern: X MINE® D2



280/75 R 22.5 **MICHELIN®**
X TERMINAL T® TL 168 A8
TIRE

- Radial construction
- Nominal section width of the tire (in mm): 280
- Tire series: aspect ratio = 0.75
- Inner diameter of the rim (in inches): 22.5
- Tubeless
- Brand: MICHELIN®
- Tread pattern: X TERMINAL T®

- 12 Maximum speed = 25 mph (40 km/h)
- 13 CYCLIC
- 14 - Load index of the tire: 168
- Reference speed symbol of the tire: A8
- 15 Antistatic tire



40.00 R 57
MICHELIN®
XDR® 3 E4R TL **
TIRE

- Radial construction
- Nominal section width of the tire (in inches): 40
- Inner diameter of the rim (in inches): 57
- Tubeless
- Brand: MICHELIN®
- Tread pattern: XDR® 3
- Identification code: E4 (transport, "deep" tread)
- Load capacity: **

HANDLING AND STORING TIRES

3

20 INTRODUCTION

21 HANDLING TIRES:
ESSENTIAL PRECAUTIONS TO ENSURE
THE INTEGRITY OF TIRES

23 STORING TIRES:
ESSENTIAL PRECAUTIONS
TO PROTECT TIRES



HANDLING AND STORAGE

Handling and storing earthmover tires has nothing to do with luck.

Earthmover tires come in a wide range of sizes and weights, including extreme sizes, which determine how they should be handled.

The right handling methods must be used for these tires to ensure they maintain their performance levels. It is generally necessary to use special equipment.

Storage demands the same rigorous approach. Proper organization and appropriate precautions are essential to ensure the integrity of the tires, in particular when faced with harsh climatic conditions.

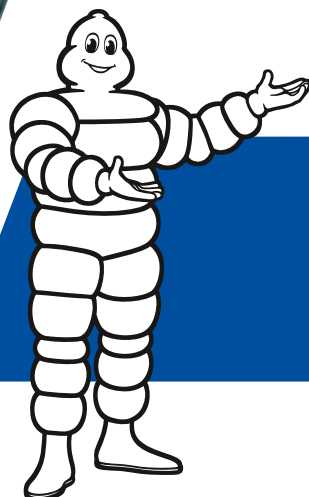

A tire that is protected will last a long time and remain safe. Safety, a long service life and energy efficiency are key values for Michelin. Important recommendations regarding these three aspects associated with the life of the tire are given in this chapter.

Handling tires: essential precautions to ensure the integrity of tires



Holding the tire too tightly may distort it

Precisely defined methods must be used when handling tires. Failure to use these methods may cause irreparable damage to tires and may even be dangerous.

The bead is a sensitive part of the tire, and if it is damaged during handling operations, this may lead to premature scrapping of the tire.

To limit the risks:

- tires should preferably be handled using the appropriate equipment for this type of work: forklift truck, mechanical loader or crane equipped with a tire handler or textile straps;
- lift the tire by the tread.



Caution!
Holding the tire too tightly or picking it up by the bead may permanently distort it and prevent its being mounted on the rim.



If there is no other option than to lift and handle the tire by the beads, the following must be used:

- preferably wide textile straps (do not use metal slings or chains as these may damage the beads);
- or, if need be, a forklift truck equipped with a large-diameter boom attachment (fitted in place of the fork). *In this case, care must be taken not to damage the sidewalls!*



Incorrect handling may cause irreparable damage

Handling instructions for MICHELIN earthmover tires using mechanical equipment



MICHELIN tires are designed to give our customers the best response to their requirements in accordance with their conditions of use.

But between leaving our factories and their being mounted on machines, our tires often cover several thousand kilometers, carried on different types of transport.

During this journey, incorrect handling of a tire may cause it irreparable damage, making it unusable before it has even been put into service!

Our recommendations:

Tools	Permitted	Prohibited
 <p>Hoist</p>	 <p>The hoist ring, or ringlet, passed through the center of the tire or raised the bead.</p>	 <p>Metal rings, chains, cables or cordic hooks.</p>
 <p>Fork</p>	 <p>The placed on the fork (flat or vertically).</p>	 <p>Forks passed through the center of the tire.</p>
 <p>Clamps with pins</p>	 <p>Use the tread bearing (as not to cause any damage with the pins).</p>	 <p>Use the sidewall.</p>
 <p>Smooth clamps</p>	 <p>No dirt must be added by the sidewall.</p>	
 <p>Boom attachment</p>	 <p>They're pulled, pushed through the center of the tire.</p>	

A reminder of the instructions is fixed to each tire concerned in accordance with the above example.



Please follow these recommendations



Loader with tire handler



Positioning with straps

Storing tires: essential precautions to protect tires



Adhere to the storage rules

The rubber used for tires is subject to natural aging.

To prevent storage shortening the lifetime of tires, they must be stored under specific conditions and for a limited length of time.

Indoor and outdoor storage: different rules.

Indoor storage is preferable.

- Moisture, high temperatures (also significant variations in temperature) and light are all factors that speed up the aging of the rubber. These are increased in areas with high levels of sunlight and/or exposed to frequent storms (presence of ozone).

- The storage area must be large enough for the handling equipment to be able to move around without any risk of rubbing against the tires or hitting them.

Tires must be stored in dry, enclosed buildings.

Outdoor storage is possible under certain conditions:

- recommend limiting storage period outdoors to 4 months;
- ground clean and well-drained, and with no rough areas that could damage the tires. Avoid grassy or muddy areas;
- do not store close to powdery materials, combustible products or pollutants (oil, grease, hydrocarbons, etc.);
- store tires away from electrical welding units, battery chargers and generally any source of ozone production (power plant, transformers, etc.);
- cover the tires with opaque sheets, as long as they are well-ventilated to prevent any condensation.



Semi-outdoor storage



Outdoor storage



Always use caution to ensure there are no potentially harmful animals (snakes, insects, etc.) when inspecting tires that are stored in the open air.

*Tire storage methods:
different methods for different tire sizes.*

TIRE CROSS-SECTION	VERTICAL	SLOPING	ALTERNATING	HORIZONTAL
	on tread	on one shoulder	upper row: sloping lower row: vertical	on sidewall
< 355 mm (14")	YES	YES	YES	≤ 2.2 yd* (2 m)
355 < tire ≤ 680 mm (14" to 27")	YES	YES	YES < 35" seat	≤ 4.2 yd* (3,8 m)
> 680 mm (27")	YES	NO	NO	≤ 4.2 yd* (3,8 m)

* Risk of difficulty to inflate in case of prolonged storage (more than 1 month); use the tires FIFO (First In, First Out)



Vertical storage



Sloping storage



Alternating storage



Horizontal storage



Tires mounted on rims must be stored at a maximum pressure of approximately 29 PSI (2 bar, 200 kpa).

*Storage methods for associated products:
inner tubes, flaps and O-rings*

- Inner tubes must be stored in their original packaging so that they are not exposed to light.
- Flaps must be stored flat on shelves, protected from dust, moisture and grease-based pollution.
- O-rings, when supplied with the tires (in sealed plastic bags), must be removed from the tires during storage. Store them away from the light. Protect them from any risk of being crushed or distorted, which could damage the airtightness of the tire when mounting on the rim.



Never hang up flaps.

For O-rings, use a large-diameter circular rack to hang, which can minimize the stress on a particular section.

Indoor storage conditions: essential fire safety rules

Tires are combustible, and are therefore subject to regulations concerning their storage and protection against fire risks.

 **Strict compliance with the current regulations in the country, or even the locality, in which tires are stored is essential.**

Storage precautions according to the fire extinguishing equipment

Tires must be stored in areas with a maximum surface area of 500 m² (0.12 acre). The maximum «stack height» for tires to be used must take into account the site's fire extinguishing equipment capabilities. Any tire storage area must be at least 20 m (22 yd) distance from the closest building.

● **Fire-fighting equipment**

- Minimum equipment consists of one extinguisher every 27 yd for 0.05 acre (25 meters for 220 m²). Ensure that it is accessible.
- For larger surface areas, fire hose cabinets should be installed.
- For very large areas, sprinkling equipment with automatic detection is recommended or even mandatory.
- The extinguishing products used must not be harmful to rubber, to avoid any damage in the event of accidental activation of the sprinkler system. The best extinguishing agent is still water.

● **"Safety" information in the workplace**

To inform everyone and raise their awareness of safety with respect to tires, Michelin provides "Safety" communication kits.

They consist, for example, of an informative wall chart and a safety booklet. These kits are available on request from Michelin technicians.

● **Evacuation instructions**

- The building evacuation instructions must be clearly displayed.
- It is also recommended that regular fire drills are carried out.

● **Safety label**

All earthmover tires carry a label listing the basic precautions. This is attached to the tread (in the United States) or on the sidewall (in all other countries).

TIRE FIRES AND THEIR PREVENTION

28 INTRODUCTION

29 TYPES OF FIRE
TO WHICH A TIRE MAY BE SUBJECTED

30 IGNITION OF AN UNMOUNTED TIRE

31 PUTTING OUT A TIRE FIRE

32 PREVENTION AND TRAINING

33 HOW TO REDUCE THE RISKS OF TIRE FIRES
DURING OPERATION



TIRE FIRES AND THEIR PREVENTION

Due to the nature of their components, tires are officially classified as "combustible products."

Their combustion parameters are similar to those of coal.

There are various types of tire fires, some of which are very difficult to detect, for example internal fires.

The smoke is potentially toxic.

Information:

- *A tire may catch fire for various reasons, while in storage or during use.*
- *A tire fire may also be triggered by an external energy source, whether this is natural (lightning) or due to other circumstances (electric arcs), and may even be the consequence of a human action.*

PREVENTION AND TRAINING: two essential actions

A tire fire is difficult to put out.

A tire may even burst up to eight hours after the fire.

The relevant instructions and procedures must therefore be followed to the letter.

"GOOD PRACTICES"

The last page of this chapter gives a summary of the guidelines for reducing the risks of fire for tires during use.

Types of fire to which a tire may be subjected



A tire fire gives off a great deal of smoke...



...and takes a long time to put out.



More than 3000 liters of water is needed to extinguish one ton of tires



Fire caused by brake overheating

Surface fire

Combustion on the surface of the tread or the sidewalls caused by an external heat source.

Internal fire

Combustion of the internal rubber as a result of excessive overheating of the tire during use. The fire is then undetectable.

Accumulation of flammable gases (hydrocarbons and carbon monoxide) resulting from incomplete combustion can lead to a risk of explosion.

Spontaneous ignition

Combustion occurring when the tire is in contact with, or in the immediate vicinity of, a high-temperature heat source.

External energy sources: lightning and electric arcs

Lightning: may strike any vehicle when parked or in use.

Electric arcs: avoid passing below high-voltage lines and do not drive over electric lines on the ground.

Lightning and electric arcs affect all tires near the point of impact. They must all be demounted and destroyed.

Rims/wheels that have been struck by lightning must be carefully inspected by qualified personnel before possibly being put back into service.

If in any doubt, they must be destroyed.



Beware of lightning



Keep away from high-voltage lines

Ignition of an unmounted tire

Potentially toxic smoke

The main components of smoke from tire fires are:

- gases, mainly carbon monoxide (CO), carbon dioxide (CO₂), sulfur dioxide (SO₂) and also certain nitrogen compounds (NO, NO₂, etc.), aldehydes, hydrocarbons, halogenated acids, etc.;
- soot (fine particles of carbon) causing large amounts of black smoke which are similar to hydrocarbon smoke.

The composition of the smoke depends on the combustion conditions: the proportion of carbon monoxide is inversely proportional to the temperature and the oxygen supply.

Inhaling smoke from tire fires can be dangerous

Tire smoke is dangerous if it is inhaled in high concentrations.

It can cause:

- irritation and congestion of the upper respiratory tract and the lungs (due to the soot);
- breathing difficulties due to the irritants (acid fumes from the sulfur and nitrogen compounds);
- carbon monoxide poisoning which may, at high concentrations, cause various problems ranging from coma to death by asphyxiation.



Smoke from tires filled with solid polyurethane are particularly toxic (see the «Inserts and solid fillers» chapter).

Ignition of a tire that is mounted and inflated

Additional heat may, as a result of an accident, negligence or chance, trigger an internal fire, which is undetectable:

- carrying out welding on a rim on which a tire is mounted (even if it is not inflated);
- overheated brakes;
- fire in the machine on which the tire is mounted;

- lightning strike;
- electric arc: proximity of high-voltage electricity lines, contact with electric cables (including those lying on the ground);
- direct contact with external heat sources (flames, hot slag, etc.).



- > **Beware of the risk of internal fires, which are undetectable!**
- > **A tire may explode at any moment during or after a fire.**

Explosions have been reported up to eight hours after a tire fire has been put out.

Putting out a tire fire

Tire fires are difficult to put out completely

The fire services aerate this type of fire a great deal in order to get rid of the smoke, which slows down the extinguishing process.

A great deal of water is required to put out a tire fire: more than 800 gal / US ton (3.000 liters / ton of tires).



Do not try to put out a tire fire with an extinguisher

What should you do following a tire fire?



After the fire has been put out, scrap the tires

Wait 24 hours after the fire has been put out before entering the site:

- deflate all the tires concerned, scrap them in accordance with the regulations in force and scrap the wheels;
- do not forget to thoroughly inspect tires that seem to be undamaged but which, due to their proximity to the fire, may have been affected.

Any tire that is visibly damaged, or about which there is any doubt, must be destroyed.



Inhaling smoke from tire fires can be dangerous

Prevention and training

Any site using earthmover tires must:

- formalize (and keep up to date) the procedures to be followed and the conduct required in the event of fire;
- ensure the necessary emergency equipment for fighting tire fires is available to the response staff;
- train the staff working on the site;
- carry out periodic fire drills;
- check the emergency equipment regularly.

Conduct in the event of fire: initial actions and alerts

The machine operator must:

- adhere to the current procedures and instructions applicable on the site;
- drive his machine to an isolated area, engage the parking brake and turn off the motor;
- activate the automatic fire suppression system fitted on the machine (if available);
- leave the machine from the side opposite the fire. Move at least 220 yd (200 meters) away from the machine. This is the minimum totally safe distance in the event of a tire exploding;
- inform the site manager and await the arrival of the emergency staff;
- do not block the access roads unless instructed to do so.

The team leader must:

- alert the fire service and direct them so that they have rapid access to the location of the fire;
- evacuate the area around the fire and ensure it is secure;
- when the fire is completely out, continue monitoring from a distance and ensure no one approaches the machine for 24 hours;
- analyze the cause(s) of the fire and draw any necessary conclusions, and if appropriate, modify the machinery maintenance plan.



A tire fire is very difficult to put out completely.



How to reduce the risks of tire fires during operation



This is a non-exhaustive list of "good practices" which can help to reduce the risks of tire fires or explosions.

- **Use the right tires for the application.**
Consult the manufacturer on the load and speed limits.
- When mounting tires, **do not spray products from aerosol cans into the tires** and check that no foreign bodies have been inadvertently left in them (for example, wooden packing pieces).
- If the tire is inflated with air, **check that no flammable vapor** (alcohol, liquids stored nearby) **is taken in by the compressor** (risk of transfer to the tire).
- **Inflate the tires** and **adjust the pressure, using nitrogen** rather than air.
- **Keep the inflation pressure** at the level recommended by the manufacturer.
- **Fit machines with a remote tire pressure monitoring system (TPMS)**, for example MICHELIN® MEMS® 4.
- **Equip machines with an automatic fire suppression system.**
- **Never carry out welding or heating on the wheel before removing the tire from it.**
- **Mark out the site haul roads**, avoiding steep slopes and tight corners to limit heating of the machine's brakes. **Drive at speeds appropriate for the road.**

TIRE MAINTENANCE WORKSHOP

36 INTRODUCTION

37 ORGANIZATION OF THE WORKSHOP

38 SAFETY INFORMATION



TIRE MAINTENANCE WORKSHOP

A few key concepts for logical organization...

Whether the tire maintenance workshop is within a specialist retailer's premises or on-site (mine, quarry, building site, port area), its organization must fulfill the following objectives:

- enable top-quality work to be carried out;
- contribute to the safety of the tire maintenance operations carried out in the workshop;
- reduce the amount of handling;
- make it easy to keep the area clean and tidy.

The organization described here concerns fixed workshops but can easily be adapted for mobile workshops.

These guidelines must be adapted according to the constraints of each site in terms of space and organization of the work.

The workshop may include a "repair area," the organization of which is covered in the "Repair" chapter.

Organization of the workshop



Technical zone of a tire workshop in a surface mine

A tire workshop is generally divided into three areas:

> Storage area

This is organized according to how and where the tires are to be used: new tires, those awaiting maintenance work, those to be remounted (partially worn), those to be scrapped, "associated items," etc.

Each of these areas must be clearly identified to avoid any confusion.

The storage must be organized in accordance with the rules specified in the "*Handling and storing tires*" chapter.

> Technical area

This comprises the tire "washing," "operations" and "inspection" areas.

> Administration area

This is the workshop office, with its computer equipment, technical documentation, wall charts on vehicle and tire monitoring, tire records, etc.

This area may also include a staff room (changing room, eating area, etc.) and a meeting room.

Storage area: order and identification are the two essential concepts here

● Tire storage

To simplify handling operations, stock must be near the tire workshop in a space that is large enough for handling equipment to be able to move around in complete safety.



Tires awaiting inspection, repair, regrooving or retreading (and tires for scrapping) must be stored in separate islands and clearly identified. As much as possible, the destination of the tires must be clearly marked.

The tires should preferably be under cover to prevent:

- water, snow or dust getting inside the tire;
- daylight and sunshine damaging the components of the tire.

● Storage of associated items

Using tires requires the use of numerous associated items: inner tubes, flaps, o-rings, valves and valve bases, rings, bands, etc.

To ensure they remain in good condition, it is recommended that:

- they are kept in a clean, dry place (see the "*Handling and storing tires*" chapter);
- they are carefully identified;
- any item that is in poor condition or whose quality is questionable must be removed from stock.

The performance of the tire also depends on the use of these items. Their storage and maintenance, which is sometimes neglected, can be the cause of a tire having to be taken out of use prematurely.

Technical area: allocate different areas for different tasks

● **Washing area**

This area, specifically for washing machines, wheels and tires, must have a wastewater collection system and, depending on local legislation, must comply with regulations on the storage and discharge of this water.

● **Mounting/demounting area**

This flat, concrete area must be laid out so that machinery can be immobilized and lifted (operations that have to be carried out prior to any mounting and dismounting work).

The area must be large enough for handling vehicles to be able to move around immobilized machines.

For the safety of operators, the perimeter of this area must be marked out on the ground: paint or safety cones around the edges, etc.

The compressor must be installed near the inflation area, ideally in a dedicated room (soundproof, free from volatile pollutants).

● **Inspection area**

This must be covered. The area provided must be large enough for the largest tires used on the site to be handled (using a forklift truck fitted with a tire handler or a hoist equipped with wide straps).

It must be close to the mounting/demounting area, and have:

- excellent lighting (natural and electric light);
- supports for inspecting tires (provide a frame that can take the largest size used on the site);
- an electrical rotation system for tires that are too heavy to be rotated manually on the support frame.

The equipment required is detailed in the "*Inspecting demounted tires*" chapter.

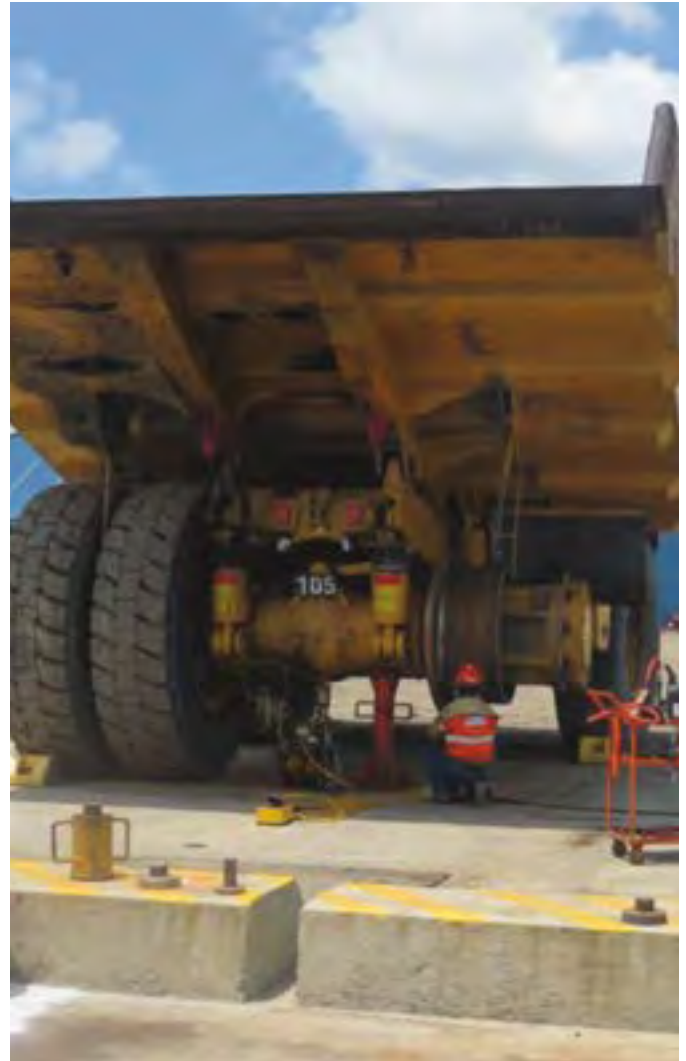

Outside: mounting/demounting area

Safety information

The safety equipment must comply with any instructions specific to the site and with current legislation.

There are various safety aspects:

- safety and protection of people: a first aid kit must be available and easily accessible in the office. It is recommended that the safety instructions and emergency telephone numbers are displayed in this room.
- safety around the handling and storage areas: see the "*Handling and storing tires*" chapter.

- safety around machines: see the "*Inspecting tires on a machine*" chapter.
- safety during tire maintenance work: see the Safety sections in the "*Inspecting demounted tires*," "*Mounting and demounting*," "*Inflation and checking the pressure*," "*Duals Usage*," "*Regrooving*" and "*Repairing tires*" chapters.
- fire safety: the minimum equipment consists of one or more extinguishers for class C fires (checked annually by qualified technicians) and a hydrant. See also the "*Handling and storing tires*" chapter.

MOUNTING AND DEMOUNTING

40 INTRODUCTION

41 GENERAL PRECAUTIONS
AND OPERATOR SAFETY

43 MOUNTING OPERATIONS

45 DEMOUNTING OPERATIONS

46 STEPS IN THE MOUNTING
AND DEMOUNTING PROCESSES



MOUNTING AND DEMOUNTING

An incorrectly mounted tire wears faster! It can damage the vehicle on which it is mounted and may even cause serious and occasionally fatal accidents.

Mounting and demounting earthmover tires requires special training and great care, as the size of the machines and that of the tires makes each of the operations to be carried out potentially dangerous.

For this reason, mounting and demounting earthmover tires is a job for technicians who are familiar with the procedures to be followed and the precautions to be taken.

The right equipment must be used.



General precautions and operator safety



Precautions for staff: they must be trained and adhere to instructions and procedures!

Mounting must always be carried out by trained staff in accordance with the current regulations in the country concerned (when they exist).

Safety is paramount!

Fitters must wear:

- the following protection equipment at all times: hard hat, protective glasses, gloves and safety shoes;
- a fluorescent jacket when the technician is working outdoors;
- according to the tasks to be carried out: ear protection (mounting, demounting, etc.), dust mask (cleaning rims, paint, etc.).

If the work is carried out on-site by external staff, a member of the local staff should be present, as only that person is familiar with the organization and the safety instructions.

If there are no site-specific safety instructions, see the "Introduction to safety" chapter.

Depending on the size of the tire and the handling equipment used, it is often necessary to work in pairs in order to carry out the various operations safely.



Always check the condition of the straps before use!

Use the appropriate equipment

Working on earthmover tires generally requires the use of handling equipment to move and position them.



In a great many countries, an operator using a machine must hold an official qualification to drive the equipment concerned.

Use the right equipment for the sizes and weights of the tires concerned: crane or forklift truck, preferably equipped with a tire handler or a hoist equipped with straps. To avoid damaging the beads, never let them come into contact with steel slings or chains.

Ensure the machine is safe before mounting or demounting tires

Only work on machines that are:

- unloaded;
- parked horizontally on a clear, level, clean area;
- parking brake engaged and motor turned off.

Make parked machines safe

- Articulated machines: place the locking link(s) in position.
- Rigid dumpers: use the lock-out/tag-out (if there is one).
- Loaders: lower the arms and place the bucket in contact with the ground.

Use blocks to immobilize the machine horizontally and vertically.



Machines parked on a flat, clear, level, clean area



Using blocks to immobilize a loader



Holding a tire too tightly when handling with a tire handler may distort it and prevent subsequent correct positioning of the beads on the rim (or make it more difficult to remove when demounting)

Mounting operations

Before mounting, inspect each of the parts of the assembly to be mounted

- **Tire:** check that the tire has no abnormal distortions, inside or outside, and no visible or potential damage. If there is any damage or you have any doubts, isolate the tire and get it inspected by a qualified technician.
- **"Tire-rim" assembly:** check they are compatible with one another (if necessary, consult the manufacturer's recommendations).
- **Rim:** generally made up of the rim base, flanges, bead seat band and locking ring. Check that the various parts are compatible with one another and that they are in good condition. Remove any traces of rust. If there are any distortions or cracks, scrap the part in question.
- **Flanges:** check they are the right height for the size of the tire to be mounted (see *Earthmover and Handling technical documentation and the "Permitted rims" chapter*).
- **One or two locking rings:** its shape must correspond to that of the rim gutter on one side and that of the bead seat band on the other.
- **Condition of the fixing components:** check the general condition of the wheel rim clamps, nuts and studs. Remove any traces of rust.

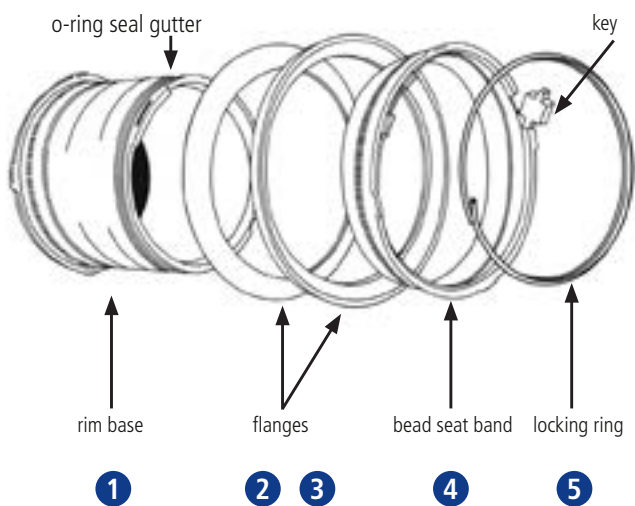

Components of a 5-piece rim

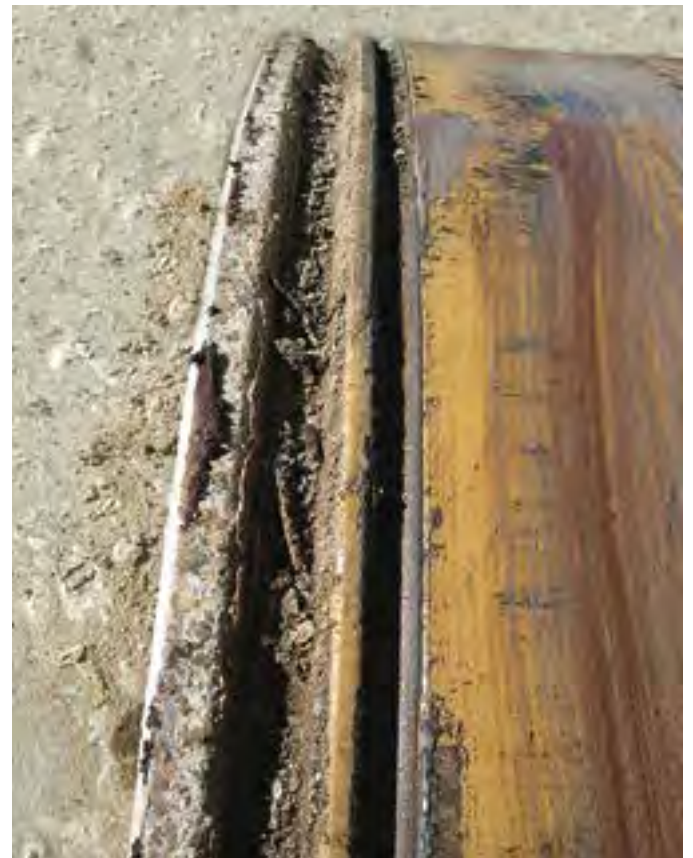

Clean the rim components

Always follow the recommended procedure when mounting tires

- Refer to the wheel manufacturer's instructions and/or the documents provided by Michelin: procedures, e-training, etc.
- Lubricate the areas of the tire that need it. Use a vegetable oil-based product (Tiger Grease 80 or equivalent).
- Place all the wheel components in position and visually check that they are correctly assembled.

• Which way round should you mount a tire?

- When a tire has to be mounted facing a particular way (mainly tires for self-propelled cranes), mount the tire so that the "outside vehicle" marking is visible on the outside of the vehicle;
- When the tread pattern has to run in a specific direction, mount the tire with the points of the blocks facing toward the front of the vehicle;
- In all other cases, the direction of mounting does not matter.

• Always replace:

- The o-ring (the correct size for that of the "tire-rim" assembly);
- The valve and its seal and, if necessary, the valve base and extension.

- **Tighten the nuts** in accordance with the procedure provided by the manufacturer of the machine.



Tire mounted with the "Outside vehicle" marking visible



Tighten the nuts in accordance with the manufacturer's instructions

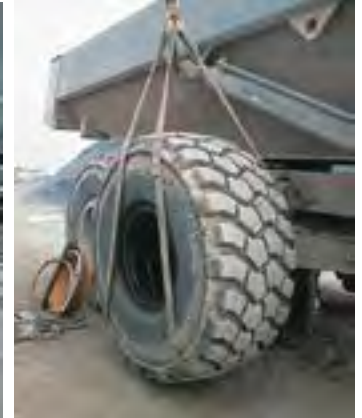

Following procedures is the most important safety measure



Never reuse O-rings, valve seals or the valves themselves!



A wooden wedge left inside a tire during mounting...



Always check that nothing has been left behind in the tire before mounting it, as any object left inside the tire would lead to a high risk of puncture or even bursting.



...150 hours later



... 55 yd (50 meters) further on



Do not use synthetic mineral lubricants and oils as they can damage the rubber and cause rapid deflation or even blowouts.

Demounting operations

Before carrying out any work on a tire, it MUST be deflated!

Deflation is:

- recommended before carrying out any work, however minor, on a tire or a rim;
- mandatory when carrying out work on dual-mounted tires (deflate both tires) or on a double-flanged rim (2 pieces, bolted together).

Deflation requires compliance with a safety procedure:

- wear safety glasses and ear protection (this is even more important than when mounting tires);
- do not stand in front of the valve;
- use a valve core remover and hold the core with your hand when unscrewing.

Following the procedure will save you time when demounting a tire

- Start by washing the tire while it is still on the hub of the vehicle.
- Deflate the tire fully.
- Use the recommended equipment and tools: tire handler, manual or hydraulic bead breaker.
- Separate the tire from the rim.
- Remove the rim by pushing at several points, a short distance apart, to avoid distorting the tire's bead wire.

Refer to the wheel manufacturer's instructions and/or the documents provided by Michelin: procedures, e-training, etc.

After demounting, check each component before carrying out any necessary repairs

- Tire: locate any damage and mark it with tire chalk for:
 - Easy identification when putting into storage (see the "Handling and storing tires" chapter);
 - Inspection of the tire before repair or retreading (see the "Repairing tires" and "Retreading tires" chapters).
- Rims (rim bases, flanges, bead seat bands and locking rings):
 - check there are no distortions, flaws or cracks;
 - remove any traces of rust;
 - if necessary repaint the rusty areas except the seats of the rim.
- Valve base and extension: general check of their condition before reuse.



Cleaning and repainting the rusty areas of metal parts

Steps in the mounting and demounting processes

DIRECT MOUNTING OF A TIRE ON A 5-PIECE RIM (WITH A TIRE HANDLER).



1 Remove any foreign bodies



2 Lubricate the beads



3 Lubricate the rim seat



4 Lubricate the chamfered part of the bead seat band



5 Place the flange on a bead



6 Push the bead seat band into the bead



7 Place the tire on the rim



8 Lubricate the conical zone of the bead seat band



9 Push the bead seat band with the tire handler



10 Fit a new o-ring



11 Fit the locking ring



12 Inflate and lightly tap the locking ring



13 Inflate to mounting pressure, then adjust to working pressure



14 Check the airtightness

DIRECT DEMOUNTING OF A TIRE ON A 5-PIECE RIM (WITH A TIRE HANDLER).



1 Unscrew the valve cap and core, then deflate



2 Push on the bead seat band



3 Remove the locking ring



4 Remove the rim seal



5 Push the flange on the chassis side



6 Remove the tire from the rim



7 Separate the bead seat band and the flange



8 Remove the bead seat band and the flange

DUALS USAGE

48 INTRODUCTION

*49 RULES FOR DUAL TIRE USAGE:
MOUNT TIRES THAT ARE
AS SIMILAR AS POSSIBLE*

*49 CONDITIONS FOR DUAL TIRE USAGE:
STRICT COMPLIANCE
WITH THE RECOMMENDATIONS*

50 REGULAR INSPECTION OF DUAL TIRE

50 FITMENT IS ESSENTIAL!

51 HOW TO LIMIT UNEVEN WEAR

*52 SPECIFIC PROCEDURES
FOR DEMOUNTING DUAL TIRES*



DUALS USAGE

This is when two tires are mounted on the same hub of one axle in order to double its load capacity.

The two tires of a dual-tire fitment behave like a single tire.

They must therefore be as similar as possible in terms of size, design and degree of wear.

This special type of fitment is reserved for machines whose function is to carry heavy loads (for example, rigid dumpers or front-loading forklift trucks).

ADVANTAGES

- Heavier loads can be carried with tires that individually have lower load indexes.
- The effects of occasional or regular overloads are limited.
- Easier repair in the event of a flat as the vehicle is not totally immobilized on the site road: it can be moved to a safe place at low speed.

DISADVANTAGES

- Mounting and demounting take longer.
- Increased monitoring of the tires while in use to minimize any problems.
- The inside dual is less visible, and thus often overlooked for maintenance.

Rules for dual-tire usage: mount tires that are as similar as possible



Dual-tire usage is for machines that carry heavy loads

In order to work together perfectly as a single unit, the tires in the same dual-tire fitment:

- must have the same construction (bias or radial) so that they behave in the same way when in use;
- must be the same size so that they have the same contact patch (respect equipment manufacturer's guidelines for tolerance);
- must have comparable inflation pressure (the difference should never be more than 1% in the same dual fitment).

It is also preferable that the dual-tire fitment has the following on the same axle:

- tires of the same brand and type;
- tires with the same degree of wear (comparable tread depths).



Failure to comply with these rules will encourage the rapid appearance of abnormal tire wear.



To limit uneven tire wear, vehicles are often fitted with differentials enabling the left dual-tire fitment to rotate at a different speed from that of the right dual-tire fitment.

Conditions for dual- tire usage: strict compliance with the recommendations

It is highly inadvisable to fit dual tires on machines that are not designed for this type of tire fitment.

Comply with the dual spacing tire fitment distance and the rims recommended by the manufacturer of the machine. Apart from industrial and port handling activities, machines must be equipped with rock ejectors to prevent foreign objects being trapped between the inner sidewalls of the tires.

Keep to the pressures recommended by the technical representatives of the tire manufacturer.



Dual-tire fitments must be protected by a rock ejector

Regular inspection of dual-tire fitments is essential!

Dual-tire fitments require even more regular monitoring than single fitments.



Regular inspection of dual-tire fitments is essential

Potential consequences of inadequate tire inspection:

- uneven wear not dealt with;
- appearance of damage on the inner sidewalls of the dual-tire fitment, caused by foreign bodies remaining permanently trapped between the dual-tire fitment;
- repeated or continuous rubbing of the rock ejectors against the sidewalls of the tires: an incorrectly adjusted or bent rock ejector causes rubbing, which will lead to puncture in the long run. Wear can turn a rock ejector into a sharp blade!
- "kissing" phenomena (contact between the inner sidewalls of dual tires), whereas under normal conditions of use, there is no contact or only minimal contact (light brushing).



Forklift truck fitted with dual tires



Kissing on a dual fitment



Dual-tire fitment of MICHELIN® XZM® TL tires



The risk of kissing is greatly increased if the tires are underinflated or if the vehicle is very overloaded (dynamic or static overload).

The rubbing between the tires then increases very significantly, to the point that it exceeds the endurance limits of the sidewalls themselves and/or the wheel mounting bolts.

How to limit uneven wear?



The tires in the same dual-tire fitment sometimes show “tapered” wear: the outer edges of the tires in the dual-tire fitment are worn more than the inner edges.

In extreme cases, this type of wear leads to tires that are worn at the shoulders being demounted, whereas the condition of the tread would allow them to be kept on the vehicle.

It is therefore necessary to delay the occurrence and the severity of this type of wear.

Several actions are recommended

Optimize the operating conditions of machines

- In quarries and in mines: appropriate design of site roads considerably reduces the occurrence of tapered wear (see the “Factors affecting the lifetime of tires” chapter);
- In handling applications: this type of wear, which is independent of the nature of the ground, is dependent on how the truck is driven. Frequent maneuvering with tight turning circles is very damaging.

Regularly rotate the tires in a dual-tire fitment

For each tire in dual, turning the tire on the rim (to change the direction of rotation of the tire) before the difference in wear between the two edges of the tire becomes too pronounced evens out the wear profile of the tires.

Interchanging the two tires (or tire assemblies) of a dual mount balances the wear between the two tires.



Appropriate design of site roads reduces tapered wear

Specific procedures for demounting dual tires

During demounting, the pressure may cause stones trapped between two dual tires to be ejected, which could seriously injure operators or cause damage in the surrounding area.



Beware of stones being ejected when demounting dual tires!

Dual-tire fitments make it impossible to check the condition of the inner rim.

If this rim is damaged (cracks or breaks around the circumference), the parts are only held in place by the wheel rim clamps.

During demounting, there is therefore a risk of ejection of the broken parts or even the tires themselves.

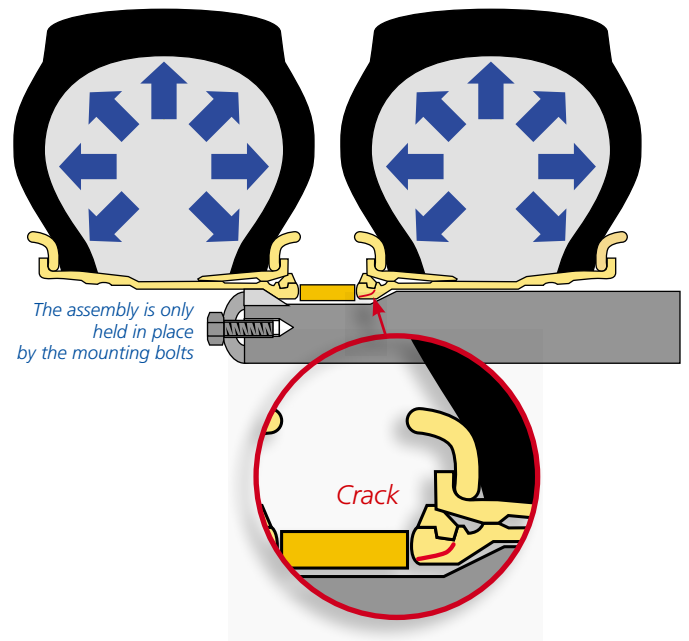

The assembly is only held in place by the mounting bolts

Crack



Before carrying out any work on a dual tire, it is advisable to always fully deflate the other tire in the dual-tire fitment.

Before demounting a dual tire, it is imperative to fully deflate both tires in the dual-tire fitment.

INFLATION AND CHECKING TIRE PRESSURES

54 INTRODUCTION

***55 INFLATION PRESSURE:
AN ESSENTIAL PARAMETER***

***57 OPTIMIZE THE PRESSURE
ACCORDING TO THE OPERATING
CONDITIONS OF THE VEHICLE***

60 INFLATION: AIR OR NITROGEN?

62 INFLATION ADDITIVES



INFLATION AND CHECKING TIRE PRESSURES

It is essential to ensure that a tire is at its optimum pressure throughout its life to ensure it provides maximum performance and has a long service life.

Regularly checking tire pressures is therefore a vital aspect of the operational management of tires during use.

Compliance with the vehicle manufacturer's recommendations and the maximum pressures given by the tire manufacturers is also a major safety element.

However, the recommended working pressure may vary within these recommendations, according to the environment, the site operating conditions and the conditions of use of the machine.

Inflating a tire is a day-to-day operation for professionals. However, it is never a trivial matter: the procedures and safety instructions must be strictly followed. Inflation accidents are rare, but when they do occur, they are generally dramatic.

Although inflation with air is the most commonly used technique, nitrogen can be a useful alternative in specific conditions.

Inflation pressure: an essential parameter



Keep to the recommended inflation pressure

Comply with the recommendations of the tire and machine manufacturers

An inflated tire is filled with pressurized air which places the cords in the casing under tension. This tension enables the tire to bear the load correctly.

This is why it is essential to maintain the pressure recommended by the tire and machine manufacturers.

Too low or too high a pressure speeds up tire wear. It can even lead to the gradual deterioration of the tire's structure or it may even burst.

The Technical Data Book ("Load/Pressure" tables) published by Michelin defines maximum pressures which should not be exceeded.



Stand 7 yd away (6 meters) from the valve

Inflation, an operation that is always potentially dangerous

- Inflating a tire requires the use of the correct equipment that is in good working order:
 - compressor (flow rate at 174 psi - 12 bar): 50 yd³/h (40 m³/h) minimum (onboard compressor), to 160 yd³/h (120 m³/h) (fixed compressor);
 - inflation hose: 7 yd minimum (6 meters).
- For safety reasons, stand facing the tread so that, if the tire bursts, you will not be in the path of the blast of air and any metal wheel parts that may be ejected.

Personal protection equipment

When inflating, deflating or checking the pressure of tires, operators must wear safety shoes or boots, gloves, safety glasses and a hard hat.

It is recommended that operators do not wear ear protection, so that they can hear any air leaks at the valve after checking the pressure.



Examples of personal protection equipment that must be worn when inflating tires

Safety during inflation

During inflation, the operator must stand facing the tire's tread, a minimum distance of 7 yd (6 meters) away from the valve.

A tire that is not mounted on a vehicle must be inflated in an area that is clear and free from tools to avoid their possible ejection. Inflation can be carried out as follows:

- vertical position: tire firmly secured to prevent any risk of falling, with the rim components (which may be ejected by the pressure) facing a wall (but some distance away from it) or toward another protective surface.
- horizontal position: with the rim components facing downward.



Inflation with tire vertical, with surrounding area protected in case of ejection of rim components

Inflation procedure

• Step 1

Inflate to minimum pressure (approximately 1 bar, 14.5 psi) while:

- Checking the gradual centering of the tire on the rim
- Observing the correct positioning of the molded guide rib on the lower part of the tire.

• Step 2

Continue inflating up to:

- a mounting pressure of 80 psi (5,5 bar) if the working pressure recommended by Michelin is 65 psi (4,5 bar) or less;
- a pressure of 110 psi (7,5 bar) if the working pressure recommended by Michelin is greater than 65 psi (4,5 bar).

Important: Check that the rim is capable of withstanding this temporary pressure (the maximum permitted pressure is marked on the rim). Otherwise, inflate to the maximum pressure permitted by the rim.

Note: When the tires on a machine have different recommended pressures according to their positions on the machine, the recommended reference pressure (i.e., the pressure to be taken into account) is the highest of these pressures.

• Step 3

Adjust the mounting pressure to the working pressure recommended by Michelin.

• Step 4

Tighten the internal valve mechanism then screw on the valve cap.

• Step 5

Check for any leaks at the valve, the valve base and, in particular, at the rim seal.



Always stand facing the tread during inflation

Incorrect inflation = shorter service life, as shown by these figures!

The curve opposite shows the consequences of an incorrect working pressure on tire performance. These are average tendencies that have been observed.

The pressures recommended by manufacturers correspond to standard operating conditions for vehicles.

These recommendations may be modified for specific conditions.

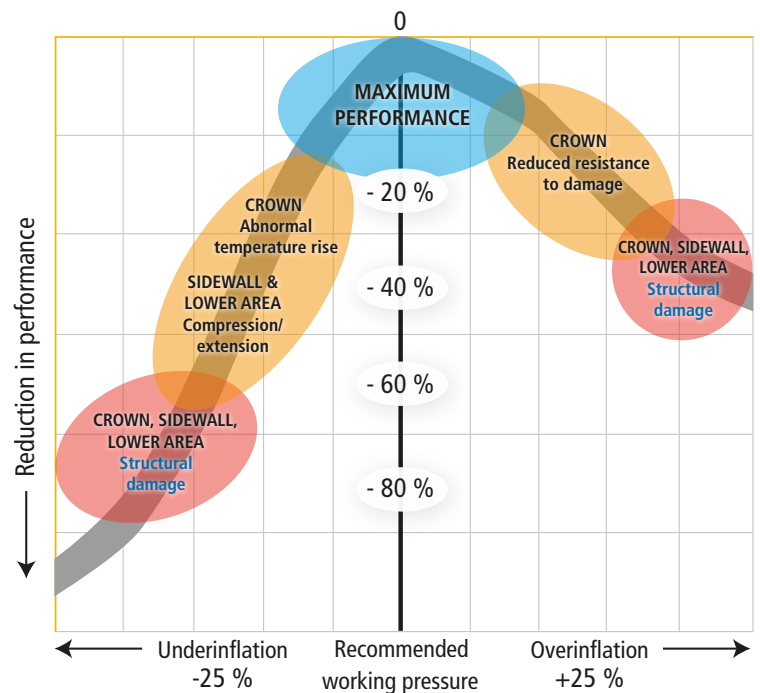

Reduction in performance due to underinflation or overinflation (%) and associated potential risks

Optimize the pressure according to the operating conditions of the vehicle

Actual load of the machine



Weighing the rear axles of an articulated dumper

To estimate the correct working pressure for MICHELIN® tires, the most rigorous procedure is to:

- weigh the machines when loaded, position by position or axle by axle;
- determine the correct working pressure for the load carried and the speed of the machine by referring to the MICHELIN® Technical Data Book.



TIP

Michelin technicians can assist you with weighing your vehicles and then advise you on the correct pressures.

Specific operating conditions

Specific usage conditions lead to modification of the machine manufacturer's recommendations, within the pressure limits defined in the tire manufacturer's technical documentation.

Need for "flotation" for traveling over soft or loose surfaces

Flotation is the ability of the machine to travel over soft or loose surfaces without sinking in.

Reducing the pressure decreases the resistance of the soft or loose surface to the forward movement of the tire (while taking into account the loads to be carried).



Modify the pressure on soft or loose surfaces

Protecting tires used on very stony surfaces

When machines are constantly moving around on stony or uneven rocky surfaces, there can be a high risk of tread blocks being torn off.

- Reducing the pressure limits the sensitivity of the tires to the harsh conditions (while taking into account the loads to be carried).



There is an increased possibility of tread blocks being torn off on stony surfaces

- It may be necessary to decrease the speed of the machine when the tire pressure is reduced to avoid adversely affecting the performance of the tires.

Finding optimum stability for loaders

This concerns loaders working at the face in mines or quarries, handling very dense materials.

Increasing the pressure of the front tires (up to 14.5 psi more - 1 bar) improves their stability (TRA* recommendations). The pressure should only be increased on the front tires.



Slightly increase the pressure of the front tires

* Tire and Rim Association

Climatic conditions

The inflation pressures recommended by the machine manufacturers, like those recommended in the tire manufacturer's technical documentation, are for a climatically temperate environment.

When an inflated tire is subject to significant variations in temperature, its inflation pressure varies: an increase in the ambient temperature results in increased inflation pressure and vice versa.

To limit deformation of the casing, the working pressure must always remain the same as (or slightly higher than) the recommended pressure. The recommended pressure must therefore take into account temperature changes (day/night or from one season to the next).

The recommended pressures:

- can only be used if the vehicle has been stationary for a length of time proportional to the size of the tires (approximately 3 hours for a 25" tire and 15 hours for a 63" tire);
- are calculated for a reference ambient temperature of 65°F (18°C), and do not require any modification as long as the external temperature is between 50°F (10°C) and 77°F (25°C).

Outside this temperature range, corrections (sometimes large) are necessary.

● Ambient temperature at the time of inflation higher than the reference temperature

If at ambient temperature (higher than 80°F • 25°C) the tire is inflated to the recommended pressure, when the temperature falls, the pressure will fall below the recommended pressure. The tire is then underinflated.

The impact of this temperature difference must be anticipated at the time of inflation by referring to the table below.

Example:

Recommended pressure: 90 psi (6 bar).

Ambient temperature when inflating: 95°F (35°C).

If the ambient temperature falls to 68°F (20°C), the inflation pressure will be 5.5 bar (6*100/108), which is below the recommended pressure.

Ambient temperature at the time of inflation	Recommended increase in pressure
+25°C and +29°C (77°F to 84°F)	4%
+30°C and +34°C (86°F to 93°F)	6%
+35°C and +39°C (95°F to 102°F)	8%
+40°C and +45°C (104°F to 113°F)	10%



Adapt the tire pressure to the climatic conditions



TIP

Michelin technicians can help you determine the pressure corrections to be applied for the environment in which your machines are used.

● Ambient temperature at the time of inflation lower than the reference temperature

• Inflation carried out in a heated workshop

The machine will work in colder ambient air: therefore the inflation pressure must be higher than the reference pressure.

• Procedure for correcting inflation pressures

The table below gives the pressure corrections necessary for inflation in a workshop according to the recommended pressure and the difference in temperature between the workshop and the outside environment.

To use this table, follow the steps below:

- 1- Calculate the difference in temperature between the workshop and the outside environment (workshop temperature – external temperature).
- 2- In the top line, find the nominal value that is closest to the calculated temperature difference.
- 3- In the left column, select the recommended pressure.
- 4- The point at which the selected line and column intersect gives you the pressure to which the tire must be inflated.

Recommended pressure	Difference between workshop temperature and external ambient temperature										
	bar	psi	10°C	18°F	20°C	36°F	30°C	54°F	40°C	72°F	50°C
4.0	58	4.2	61	4.4	64	4.6	67	4.8	70	5.0	73
4.5	65	4.7	68	5.0	73	5.2	75	5.4	78	5.6	81
5.0	73	5.2	75	5.5	80	5.7	83	6.0	87	6.2	90
5.5	80	5.8	84	6.0	87	6.3	91	6.6	96	6.8	91
6.0	87	6.3	91	6.6	96	6.9	100	7.2	104	7.4	107
6.5	94	6.8	99	7.1	103	7.4	107	7.7	112	8.0	116
7.0	102	7.3	106	7.7	111	8.0	116	8.3	120	8.6	125
7.5	109	7.8	113	8.2	119	8.5	124	8.9	129	9.2	133

Example:

Workshop temperature: 63°F (17°C),

External temperature: -4°F (-20°C).

Recommended working pressure for the tire: 87 psi (6 bar)

For the tire's working pressure to be 87 psi (6 bar), it must be inflated to 102 psi (7 bar).

• Inflation carried out outdoors

If the ambient temperature is close to the lowest temperature, inflate the tire to the recommended pressure and, when the temperature increases, deflate to reduce the pressure.

If the ambient temperature is higher than the lowest temperature, refer to the first example.

Inflation: air or nitrogen?

Inflation with nitrogen: suitable for extreme operating conditions

This technique, which means there is no oxygen in the inflation mixture, is particularly recommended when tires are used in difficult or dangerous conditions.

Main advantage: lower risk of explosion

When the internal temperature becomes abnormally high (in the region of 480°F - 250°C), the rubber self-combusts (pyrolysis phenomenon), which causes:

- releases of flammable vapors (methane, hydrogen);
- a sharp pressure increase in the tire which may, in the presence of air (oxygen), lead to its explosion.

Such temperatures can only be reached if there is additional external energy:

- particularly hot external environment: steel works, foundry, etc.;
- lightning or electric arc striking the vehicle;
- excessive temperature rise of mechanical components: heat transmission from electric motors, brakes, etc.;
- welding carried out on a tire mounted on a rim and inflated;
- accidental but long-term overheating of the tire: caused by underinflation, overinflation, exceeding the speed limit or a combination of all three.

(see the "Tire fires and their prevention" chapter).



Inflation with nitrogen requires the appropriate equipment



Long cycles increase the risks of overheating (with comparable loads and at comparable speeds)

Other advantages of inflation using nitrogen

- Limitation of the risks of oxidation of the tire components (rubber, cords, etc.) and the wheel/rim equipment.
- Slower decrease in inflation pressure during use.

When is it advisable to inflate tires using nitrogen?

For obvious safety reasons, this type of inflation is always advisable in the following conditions:

- atmospheres where there is a risk of explosion;
- contact with (or proximity to) molten materials (foundries, steel works, glass works, etc.);
- where there is a risk of electric arcs (near high voltage lines or cables, lightning, etc.);
- working conditions that may lead to a significant rise in tire temperature due to transmission of heat from the engine, hubs, brakes, etc.



The projection of all the tire/rims component has effects that are a great deal more dangerous and destructive than just a burst tire

Low pressure inflation of tires

- When the operating pressure is less than 73 psi (5,0 bar), the tire must be purged (or placed under vacuum) in order to significantly reduce the proportion of oxygen. The use of such a system is generally complicated.
- Inflation with deoxygenated air may be an alternative to using pure nitrogen, reducing the proportion of oxygen in the ambient air from 20% to less than 5%.

Additional precautions

Compressed gas cylinders must only be used by technicians who have received the appropriate training.

Never use nitrogen cylinders that are not fitted with regulators, and always comply with the supplier's safety rules.

Tire additives

Michelin's official position on the use of liquid additives in earthmover, civil engineering and handling equipment tires.

- Liquid additives are sometimes used by tire maintenance services. The main advantages claimed are that they reduce the oxidation of rims and fitted assemblies and provide preventive maintenance of wheels.
- The choice to use (or not use) liquid additives rests with the customer. However, Michelin cannot be held responsible for any damages to MICHELIN® products that are directly caused by liquid additives.
- For information on an alternative approach to prevent rim corrosion, please see the section subtitled "Inflation: air or nitrogen?" Page 60

In order to protect the rims from oxidation without adversely affecting the performance of the tires, users of MICHELIN® tires may, under certain conditions, use nitrogen for inflation.

* ETRTO : European Tire and Rim Technical Organisation

INSERTS AND SOLID FILLS

64 INTRODUCTION

65 GENERAL USAGE CHARACTERISTICS

65 RUBBER INSERTS

66 SOLID POLYURETHANE ELASTOMER FILLS

***67 SOLID FILLS AND INSERTS:
ADVANTAGES AND DISADVANTAGES***

***68 MICHELIN'S POSITION ON THE USE
OF SOLID FILLS OR INSERTS IN MICHELIN®
TIRES***



INSERTS AND SOLID FILLS

Inserts and solid fills are sometimes used instead of air or nitrogen to inflate tires.

This technique is used for specific applications where flats could cause real problems (operation in underground mines) or where flats may occur very frequently (handling in steel works, loading trucks at garbage dumps).

The intrinsic performance levels of machines equipped with such tires are reduced (lower operating speed) and driver comfort is also significantly decreased.

The use of inserts or solid fills must therefore be considered as a last resort.

Their use requires qualified staff.

Due to the nature of their components, it is generally difficult to dispose of inserts and solid fills after use.



General usage characteristics



Inserts are often used in underground mining

Performing the same functions as those of an inflated tire

The materials used to replace air or nitrogen must:

- Be chemically compatible with the rubber used in the tire;
- Provide identical functions to those of the same tire inflated conventionally, in particular with regard to:
 - ability to carry a load: equivalent rigidity;
 - traction: comparable contact patches;
 - ability of the assembly to transmit torque: identical contact pressure between the tire bead and the base of the rim.



It is essential that operations using these solutions are carried out by qualified staff.

Rubber inserts

There is a specific insert for each specific size of tire

Inserts consist of rubber inserted into the internal cavity of the tire. Their shape must therefore match the volume and profile of the tire's cavity as closely as possible.

This means that a given insert generally corresponds to one particular tire (brand, size, tread pattern).

It is very rare for one insert to be suitable for more than one type of tire.

There are several insert technologies, the most widely used of which are:

- honeycomb design;
- rubber layers.

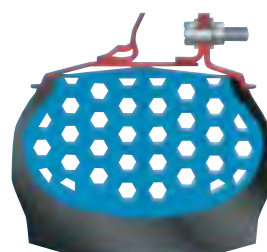

Honeycomb design



Rubber layers

Installation: special equipment is required

In order to fit the internal volume of the tire exactly, the insert must completely fill it when at rest. To install the insert in the tire therefore involves compressing it, then inserting it by force into the tire's cavity.

Mounting and demounting tire inserts requires the use of a press, which is specific to each make of insert.

When an insert is removed due to the wear of the first tire in which it has been mounted, it may be possible to use that insert a second time (comply with the recommendations of the manufacturer of the insert).

When it is mounted a second time, you must check that the insert is in contact with the internal surface of the tire at all points.

Remounting an insert which does not fit the shape of the cavity perfectly would have the same consequences as mounting an insert that is not suitable for the type of tire concerned.



Mounting an insert that is not suitable for the tire means risking significant temperature rise when running, which could lead to major damage to the tire or even its spontaneous ignition.

Solid polyurethane elastomer fills

Polyurethane elastomer comes in the form of several different liquids that have to be mixed together before being injected into the tire.

Solidification of the liquids starts as soon as they have been mixed together and may continue for several days.



Polyurethane elastomer solid fill



Radial casings deform very little and the pressure increases very fast. Particular care should therefore be taken when filling Radial tires.

Demounting and recycling

Although it is difficult to separate the tire and the solid fill, it is mandatory to do so as organizations that collect scrap tires refuse to take anything other than the tires themselves.

The tire must therefore be cut up in order to extract the solid fill and then grind it up. Standards relating to the disposal of polyurethane waste depend on local regulations which may make its disposal difficult.



Burning a tire filled with a solid polyurethane fill gives off particularly toxic fumes.

Solid fills and inserts: advantages and disadvantages

Advantages

- Increased load capacity.
- Improved stability of the machine (the tire/solid body assembly is more rigid).
- No need to check the tire pressure.
- Mobility maintained if the tire is punctured or damaged (less frequent repair work, less disruption of business).



Inserts and solid fills improve the stability of the machine, provided that the normal precautions for using the vehicle are followed

Disadvantages

- Cost of the components used equivalent to the cost of the tire itself.
- Risk of damage to the tire:
 - when mounting the inserts, if the material inserted is not suitable,
 - when filling with polyurethane, in the event of excessive pressure.
- The inserted material is difficult to recycle (due to its nature and its large volume).
- The rim + tire + component assembly is heavier, with faster wear of the main mechanical parts of the vehicle (axles, transmission, brakes).
- Disappearance (or significant decrease) of the tire's "suspension" function, with a considerable impact on the reliability of the vehicle over time, on its comfort and on operator productivity.
- Obligatory reduction of speed of movement (maximum and average) to limit temperature rise.
- Increased fuel consumption (greater inertia on acceleration and greater rolling resistance).
- Decreased traction capacity.
- Shorter tire service life: higher operating temperature and more frequent occurrence of premature damage.



The use of solid fills or inserts leads to a significant reduction in the operating speed of machines. Always consult the supplier of the product used to determine the new conditions of use for vehicles, such as load capacity.

Michelin's position on the use of solid fills or inserts in MICHELIN® tires

- The choice to use (or not use) inserts or solid fills rests with the customer. Inserts and solid fills are sometimes used under very specific conditions of use under very specific conditions of use: frequent punctures, very high stacking, etc.
- However, if reducing the frequency of punctures on L2 or L3 type Radial tires is the main objective, it is recommended that L5 type tires are used (MICHELIN® X MINE® D2 or MICHELIN® XSM® D2+ for example) inflated with air or nitrogen, rather than using inserts or solid fills.
- In some cases, Michelin can provide **Usage Restrictions** for its tires equipped with clearly identified inserts. It is then essential to adhere to these instructions provided by Michelin and the manufacturer of the insert concerned.
- The technical characteristics of MICHELIN® tires can change over the period during which they are sold. Before using any inserts, it is therefore necessary to check with the Michelin technician on the compatibility of the tires with the solution being considered.
- It is also essential that the operations to use these solutions are carried out by trained, qualified staff.
- Michelin cannot be held liable for any damage to any of its tires if it is the result of the use of inserts or solid fills.



Michelin is not liable for the use or application of solid fills or inserts in MICHELIN® tires.

FACTORS INFLUENCING THE SERVICE LIFE OF TIRES

70 INTRODUCTION

71 CHOOSING A TIRE

72 MAIN CAUSES OF TIRE DAMAGE

***74 INTERNAL OPERATING
TEMPERATURE***

***76 INFLUENCE OF THE VEHICLE
ON THE SERVICE LIFE OF ITS TIRES***

***79 INFLUENCE OF THE SITE ROADS,
KEY FACTORS FOR TIRE SERVICE LIFE***

***80 FACTORS INFLUENCING
THE SERVICE LIFE OF TIRES***



MAINTAINING
the optimum service life of tires
is an economic and environmental
issue!

Choosing the right tire and using it to its full potential optimizes tire and fuel budgets, which are both major items in operating accounts.

It also helps to ensure that work is carried out under optimum safety conditions.

Following simple rules on the use of tires is often all that is needed to increase their service life. It is therefore important to understand how they work in order to pay greater attention to their conditions of use.

Optimizing the service life of tires involves, wherever working conditions permit, paying particular attention to the design of the site roads and work areas and ensuring they are regularly maintained. The way machines are driven also affects the service life of the tire.

Using tires correctly also helps to conserve the world's natural resources.



Choosing a tire, involves making a decision based on expected performance and actual conditions of use



Regular maintenance of loading areas helps to extend the service life of tires

A tire must be exactly right for its intended use. Choosing a tire, therefore, involves deciding between all the conditions of use in order to identify the most suitable tire for the work environment.



The tire is the only point of contact between the machine and the ground



Tire on a loader working at a quarry face

Tire performance criteria

- Actual suitability for the various conditions of use: load capacity and speed, combined with adhesion, stability, traction and flotation;
- excellent resistance to damage: wear, impact and cuts;
- lower fuel consumption, achieved by limiting the weight of the tire and its rolling resistance;
- potential for the casing to be repaired or even retreaded;
- a good level of comfort and ease of use for the operator.

Numerous conditions of use

The tire is the only point of contact between the machine and the ground. The huge range of factors to which it is subjected has a major effect on its functions:

- nature of the ground;
- condition of the site roads;
- external temperature;
- pressure;
- load;
- speed.

Should the tires be changed if the operating conditions change?

Any change in a site's operating conditions (nature of the ground, length of the cycles, profile of the site roads, etc.) may result in a tire that was previously totally satisfactory becoming unsuitable, calling for the tires on the vehicles concerned to be changed.

Main causes of tire damage

External causes

Climatic conditions

The climate (wet or dry) and the temperature (high or low) also affect the integrity of the tire.

(see the "Inflation and checking the pressure" chapter).

Mechanical forces

Damage can be caused or aggravated by:

- hammering connected with regular impact on the tread blocks traveling over a very hard, smooth surface at high speed;
- centrifugal force, connected with the curvature of bends and the cornering speed;
- impacts on poorly maintained surfaces (badly graded, presence of stones, holes, ruts, etc.).



Traveling over stones significantly reduces the service life of tires

Damage connected with the use of the tires

Inflation pressure

This directly affects the service life of a tire, which may change considerably if it is underinflated or overinflated:

- underinflation: increased flexing of the tire's sidewalls causing a rise in its internal temperature and uneven wear;
- overinflation: premature wear of the tread, reduced resistance to impacts and cuts and uneven wear.

(see the "Inflation and checking the pressure" chapter).

Other causes

- Overloading: abnormal temperature rise, increased flexing and weakening of the tire's sidewalls that may lead to premature scrapping, even if the tread still shows very little sign of wear.
- Excessive speed: abnormal rise in the tire's internal temperature, causing its components to overheat, resulting in irreversible damage to the tire's structure.
- Severe, repeated and intense impacts.
- A combination of the above.



Underinflation adversely affects the service life of the tire



Damage on the bead due to overloading of the vehicle

Thermal damage

Reminder: the operating temperature of the tire is a major factor

The thermal operation of the tire is fundamental as it is the key explanatory factor in most damage.

To understand the reason for this, you must bear in mind the working cycle of a tire:

Position 1 : tire not subjected to any load stress.

Position 2 : as the tire rotates, the sidewalls are compressed causing a rise in the temperature of its internal components.

Position 3 : in contact with the ground, the intensity of the temperature rise is at its maximum. It then gradually decreases (position 4) until it returns to the initial position (position 1).

➤➤➤➤➤ *If this cycle is repeated too quickly, the tire's optimum operating temperature is exceeded, resulting in irreversible damage to its components.*

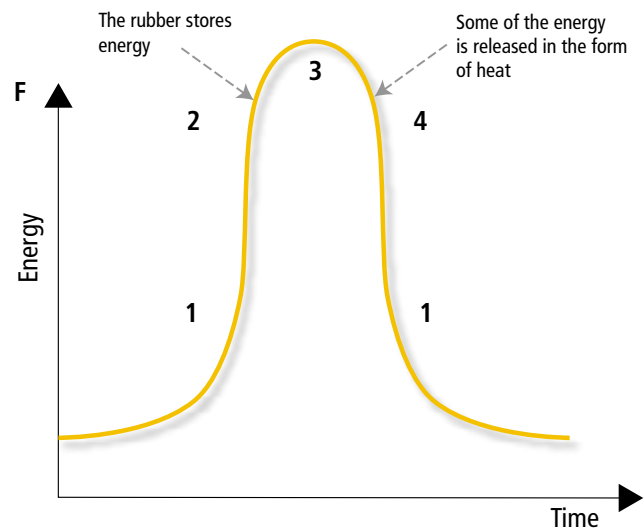
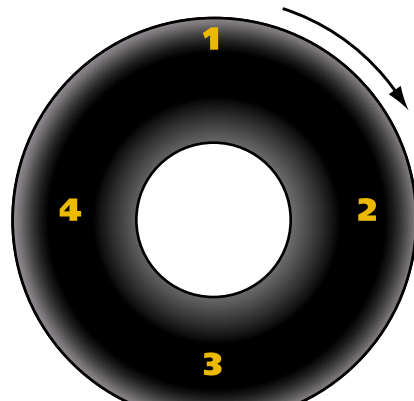

Separation of the components

Separation of a tire's components (tread and casing) is generally the result of an excessive temperature rise, due to one of the causes described previously.

The consequences of such separations can be dangerous. When they occur, it is therefore essential to carry out an in-depth inspection to ascertain the causes so that they can be remedied.

Do the following to help avoid thermal damage:

Check:

- the pressure regularly (see the "Inspecting tires on vehicles" chapter) and adjust it whenever necessary;
- the loads and their centering periodically;
- the traveling cycles and the actual operating speed;
- the vehicle's braking equipment.



Separation of the components in a tire

Internal operating temperature

A major point to be monitored on tires during use

Why does the temperature of the air inside the tire rise?

The increase in temperature is due to:

- the temperature rise of the tire itself;
- the partial transfer of the temperature rise from the brakes and gearboxes.



Critical internal temperature threshold = 80°C or 176°F

Critical temperature threshold

The critical temperature of the air inside the tire is the limit above which the level of temperature rise becomes dangerous for the tire.

If there are no external heat sources, it is generally accepted that this critical temperature is reached when the air inside the tire reaches 80°C or 176°F.

When the internal air reaches this temperature, that of the tire's components is even higher, approaching the reversion temperature of the rubber.

Monitor the internal temperature regularly and frequently

Tire temperatures must be monitored frequently and at regular intervals, so that any abnormal rise is detected quickly.

TPMS: temperature monitoring tools

TPMS (Tire Pressure Monitoring Systems) can be used for this. They are based on two different approaches:

- monitoring the air temperature at the tire valve;
- monitoring the temperature and pressure by inserting a sensor inside the tire. This system, which is more costly, is more efficient than the previous system. It is therefore generally chosen for tires intended for trucks used in quarries and mines.

MEMS®: Michelin monitoring system specifically for mining vehicles



MEMS® (Michelin Earthmover Management System) is the first remote pressure and temperature monitoring system for mining machine tires.

The MEMS system provides mining sites with a permanent tool for managing these parameters.

It sends alert signals when the temperature and/or pressure go outside the preset ranges.

As well as the data capture and simple alert functions, this system also transfers the information to the control center for processing and analysis.



MEMS® is a recognized tool for improving tire performance

Influence of the vehicle on the service life of its tires

Positions of the tires and use of the machine

The service life of tires mounted on drive axles is generally shorter than those mounted on steering axles.

For forklift trucks and reach stackers, the opposite often occurs, due to the machine's steering angle.

The tires mounted on steering axles are subjected to heavier use, except for machines which travel long distances in straight lines.



On reach stackers, the steering wheels (rear) are subjected to greater stresses even when loaded

Different diameter tires (or with differing levels of wear) mounted on the same vehicle

A difference in overall diameter (tires of different types or brands or markedly different degrees of wear) between two tires on a dual-tire fitment (for transport machines) or between the front and rear axles (for loaders) results in faster, uneven wear of the tires.

(see also the "Duals Usage" chapter)



Do not mount tires with different degrees of wear on a dual-tire fitment

However, some degree of tolerance is accepted.

For loaders, the following differences in overall diameter are accepted:

- 6% between the front and rear axles;
- 3% between the two tires on the same axle.

Tolerances defined in standard SAE J2204.

Some manufacturers recommend different values. Refer to the technical data sheet for the machine concerned.

For rigid dump trucks, the following maximum differences in overall diameter are accepted:

- 3% between the left and right tires;
- 1% between two dual tires.

For articulated dump trucks, the following maximum differences in overall diameter are accepted:

- 2% between the front and rear axles;
- 1.5% between the two rear axles;
- 1.5% between the tires on the same axle.

Mechanical maintenance of vehicles

Poor mechanical condition of a machine affects the service life of the tires it uses.

For example:

- faulty brakes can cause excessive heating of the wheels, leading to much faster wear of the tires than normal;
- incorrect alignment of the steering wheels on a transport machine leads to rapid, abnormal and different wear on the inner and outer shoulders of the tire (see the "Machine Inspection" chapter). It is then necessary to swap over the tires on the same axle during their lifetime, otherwise premature removal will be unavoidable;
- poorly adjusted suspension, play in the spindles, the ball joints and the pivots results in uneven wear, which can limit a tire's performance or even lead to its premature removal.



Check the mechanical condition of the machine regularly

Overloading machines

This occurs frequently during operation and may be due to:

- the type and/or condition of the material being carried (density, size of fragments transported);
- incorrect loading or uneven distribution of loads over the tires.

Effect of the degree of overloading on the service life of a tire (as a guide only):

Overloading (%)	Reduction in tire service life (%)
10	15
20	30
30	50



A load that is off-center can cause a specific overload on one side

Permanent overloading

If the material being transported is more dense than usual, each bucketload is heavier. It is therefore necessary to reduce the number of bucketloads emptied into the dump truck to prevent its being overloaded.

Occasional overloading

This is often associated with uneven loading, causing most of the load to be carried over one axle or tire, or on one side, etc.

Machine operation

The way machines are driven can significantly reduce the service life of the tires:

- inappropriate driving: sudden acceleration, repeated heavy braking, cornering at high speed;
- spinning of the drive wheels (scrapers during loading, loaders at the quarry face).



Inappropriate driving damages the tires

Driving and loading machines in accordance with good practice

Training operators and monitoring the quality of their work are essential factors in ensuring that vehicles are driven correctly and transport machines are loaded correctly.

Operators must:

- optimize the positioning of the various machines during loading at quarry faces;
- adapt their driving to the conditions of the site or each part of the site.

Loader operating between the loading and unloading points

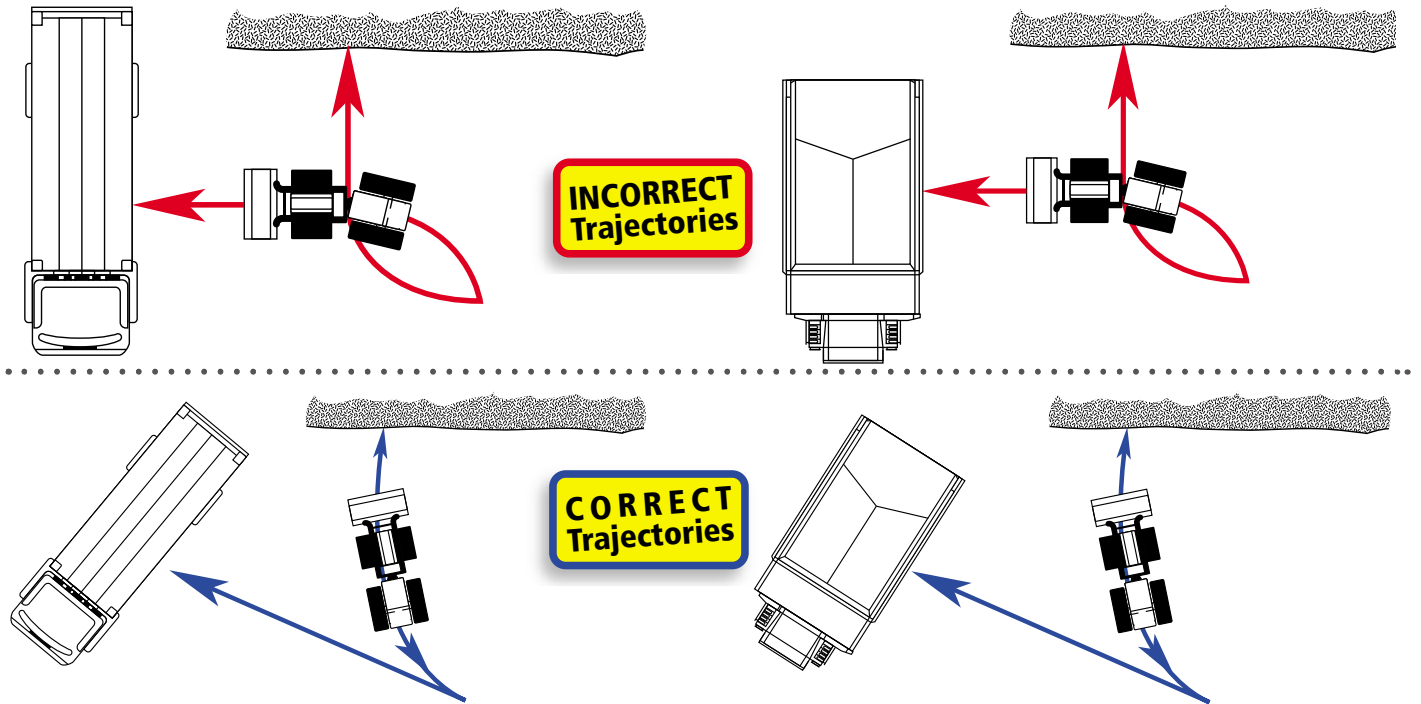

Loading at a quarry face

Influence of the site roads, key factors for tire service life

Design and maintenance of site roads

Designing suitable site haul roads

The profile of site roads (in terms of length and width), the shape and banking of bends and gradients all have a considerable influence:

- on occasional overloading during use, when loaded machines travel uphill or downhill;
- on tire scrub, increasing the possibility of separation between the tread and the casing.

For example:

- when a loaded transport machine descends a slope, the loading on the front axle increases in proportion to the gradient of the slope;
- A straight but cambered site haul road significantly increases:
 - the load carried by the tires on the inside (of the truck with twin tires);
 - the lateral forces on the front axle.

Ensure site haul roads are regularly maintained

Cleaning loading areas and removing any obstacles (rocks that have fallen off during transport, debris, etc.) limit the risks of damage to tires (impacts, cuts, punctures, etc.).

Building site haul roads

When building site haul roads, turns must be banked correctly so that the radius and gradient are compatible with the speeds at which the dump trucks usually travel.

Minimum radii must be suitable for the size of trucks and tires.

For traveling on non-banked curves, follow the instructions in the table below:

Minimum radius		Maximum speed	
15 m	50 ft	8 km/h	5 mph
25 m	80 ft	10 km/h	6 mph
50 m	165 ft	15 km/h	9 mph
75 m	245 ft	20 km/h	12 mph
100 m	330 ft	25 km/h	15 mph
200 m	655 ft	30 km/h	20 mph



Site roads with banked bends

Choose the right tires

Even the best tires will not be totally satisfactory unless:

- the right tire is chosen for both the vehicle and the conditions of use;
- they are mounted and used in accordance with the manufacturer's recommendations.



TIP

Michelin technicians can carry out studies of sites at the request of machine users and recommend the most suitable tire fitments for each type of equipment used on-site.

Length and duration of cycles

Long cycles encourage high speeds (especially on well-maintained site roads) and therefore significant temperature rises inside tires.

This may also occur if a vehicle's running time is much longer than its standing time (waiting, loading).

Factors influencing the service life of tires

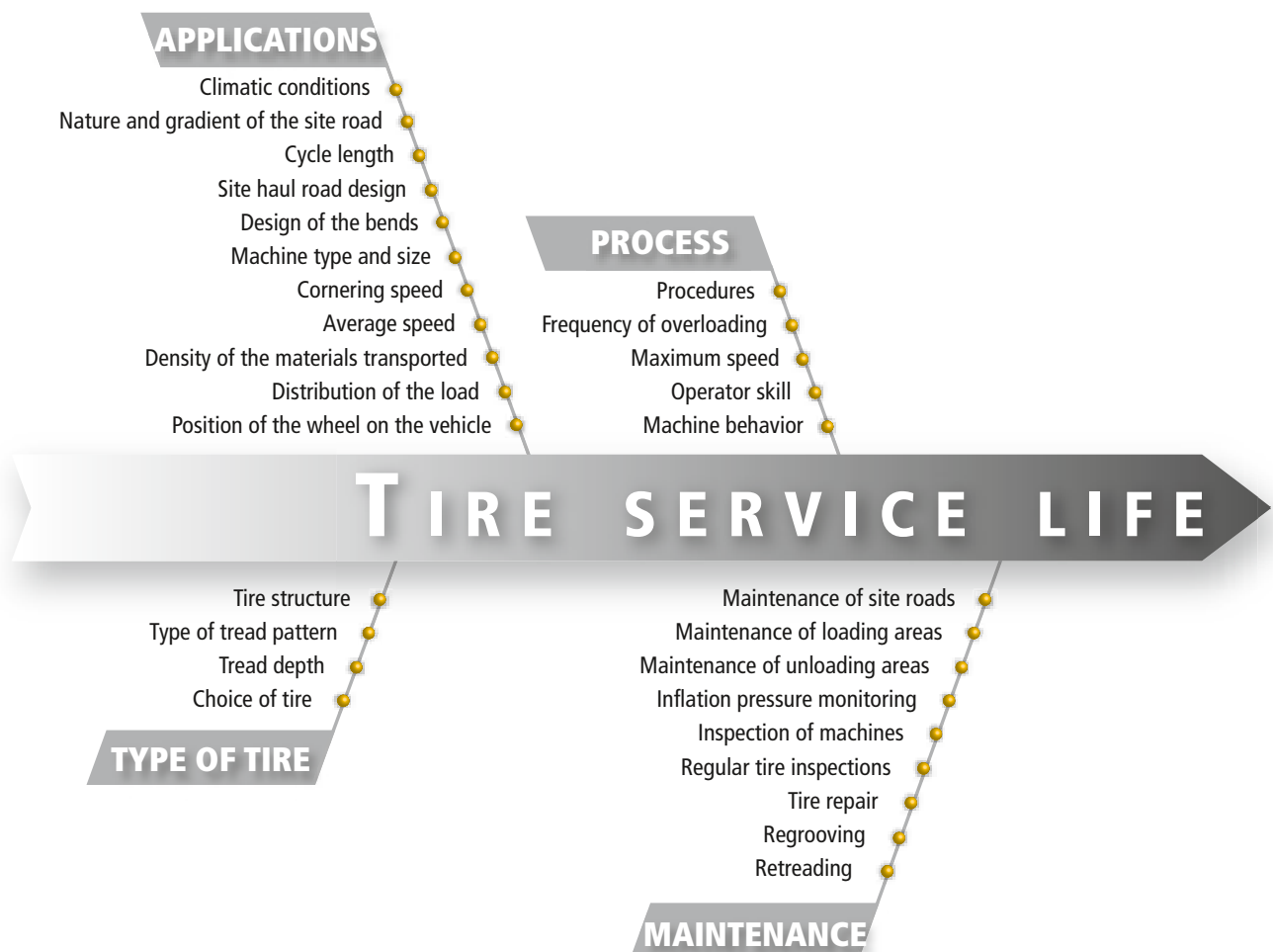

MACHINE INSPECTION

82 INTRODUCTION

83 ALIGNMENT

84 SUSPENSION



MACHINE INSPECTION

Tires are subjected to the stresses placed on them by the machines on which they are mounted and by the roads over which they are driven.

Not only does the maintenance of the roads on which they are driven affect the performance of tires, but also how the machines on which they are mounted are maintained.

Axle geometry (alignment, camber), adjustment and condition of the suspension are all extremely important parameters.

Since the camber cannot generally be directly adjusted on earthmover machines, this chapter concentrates on the adjustment of the alignment and the suspension.



Alignment

What is alignment?

Alignment refers to the angle (viewed from above) formed by the wheels on the same axle.

To maximize their lifetime, tires must remain as well-aligned as possible when running, both when the machine is loaded and when it is unloaded.

Possible alignment faults:

- "toe-in," when the distance between the front of the wheels is less than that between the rear of the wheels;
- "toe-out," when the distance between the rear of the wheels is less than that between the front of the wheels.

The recommended toe-in/toe-out values are given in the maintenance manual for each machine. It is not necessarily "0" as:

- alignment measurements are taken while stationary, preferably without any load and, if possible, with the wheels off the ground;
- the toe-in/toe-out value may be the result of a compromise between wear on the tire and behavior of the vehicle, or between alignment when empty and when loaded.

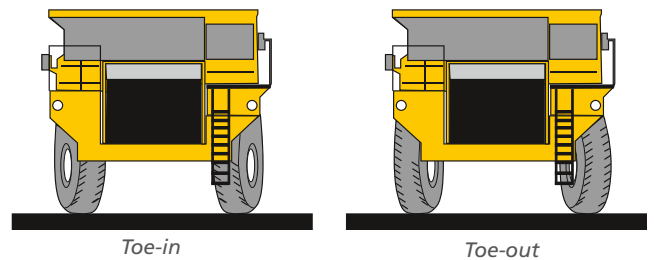

Alignment is adjusted with the wheels off the ground

Consequences of an alignment fault

Toe-in and toe-out lead to accelerated, uneven wear of the tire on the shoulders: the outer shoulder in the case of toe-in and the inner shoulder with toe-out. This is referred to as "tapered" wear, with the characteristic presence of sharp edges across the tread patterns.

This wear occurs even faster if the ground is adherent and abrasive. This is why the tolerances are smaller for machines traveling on asphalt roads than for those working on site haul roads or loose soil.



Tapered wear

Adjusting the alignment

Alignment is **only adjusted on the steering axles**; It is by nature fixed for a rigid axle.

The alignment is generally adjusted by altering the length of the steering rod(s), which are usually threaded for this purpose.

The manufacturer's recommended toe-in/toe-out values are given in the maintenance manual for each machine.

For vehicles with more than two axles (certain cranes and straddle carriers), the alignment is adjusted by checking that the axles are correctly aligned with each other.



Adjusting the alignment involves checking the alignment of the axles

Suspension

The only earthmover machines that have suspensions are rigid and articulated dumpers, straddle carriers and cranes.

Various different technologies are used to stiffen the suspension vertically: leaf or coiled springs, pneumatic or hydropneumatic cylinders, etc.

With hydropneumatic suspension only, the stiffness can be adjusted by altering the inflation pressure. Any leakage of gas or oil modifies the characteristics of the suspension.

Adjusting the suspension

The method varies according to the make and type of machine. It is specified in the maintenance manual for each machine.

It generally involves the following steps:

- place the machine on blocks, with the wheels off the ground;
- bleed the pressurized gas from the suspension components;
- top up the oil to the level recommended by the manufacturer;
- repressurize the suspension components to the recommended level by adding gas (generally nitrogen);
- place the machine back on the ground.

Correct adjustment can only be carried out in a workshop, using the appropriate equipment.



To adjust the suspension, the vehicle must be placed on blocks

Detecting incorrect adjustment of the suspension

General method: look at the visible parts of the suspension cylinders

The vehicle must be parked empty on a flat, horizontal surface.

The difference in the length of the visible parts of the rods of the suspension cylinders on the same axle and/or the presence of traces of oil on these cylinders can indicate the condition of the suspension.

Method for rigid dumpers: use weighing machines to check the distribution of the loads on each tire

This method is very accurate, but complex. It consists of:

- measuring the load carried by each of the tires (or dual-tire fitments) on the machine, empty and loaded;
- then observing the distribution of the load

1st step : check the pressure of the tires.

2nd step : weigh the machine.

3rd step : determine the theoretical load carried by each tire or dual tire unit.

Method of calculating the load carried on each tire or twin-tire unit

For a given total load:

$$\text{Load carried by each tire or dual-tire unit} = \frac{\text{Load carried by the axle} \times \text{Load carried by the side}}{\text{Total load}}$$

A difference between this theoretical (calculated) load and the measured load indicates incorrect adjustment of the suspension.

Example

The diagrams below are given for information purposes only: for each position, the numbers indicate the loads measured.

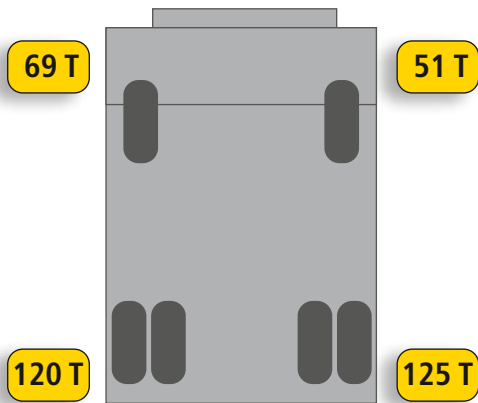

The diagram opposite corresponds to the same truck after adjustment: the measured and calculated loads are identical.

The theoretical distribution of the load is calculated by applying the formula described above:

• left front tire:

$$\frac{(69+51) \times (69+120)}{(69+51+120+125)} = 62 \text{ tons vs. } 69 \text{ tons measured}$$

• right front tire:

$$\frac{(69+51) \times (51+125)}{(69+51+120+125)} = 58 \text{ tons vs. } 51 \text{ tons measured}$$

• left rear dual-tire unit:

$$\frac{(120+125) \times (69+120)}{(69+51+120+125)} = 127 \text{ tons vs. } 120 \text{ tons measured}$$

• right rear dual-tire unit:

$$\frac{(120+125) \times (51+125)}{(69+51+120+125)} = 118 \text{ tons vs. } 125 \text{ tons measured}$$

The theoretical loads do not correspond to the measured loads: the suspension is therefore incorrectly adjusted.

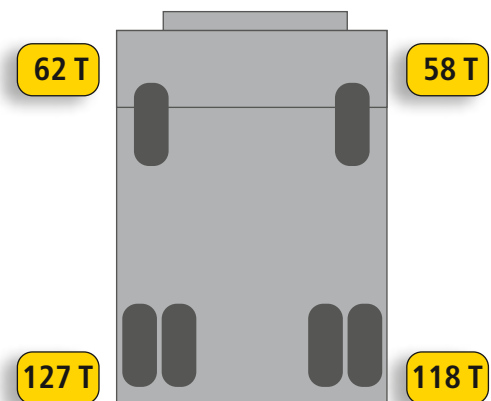

TIP

Michelin technicians can help you organize a weight study and advise you on the method to use.

The load is not necessarily equally distributed across two tires in dual. Factors such as overall diameter and inflation pressure can impact the distribution of the load between the tires in dual.

Consequences of incorrect adjustment of the suspension

Incorrect adjustment of the suspension can lead to the overloading of certain tires.

Although the wear on the tires may seem visually similar to that of an alignment fault, there is a clear difference when you touch them: there are no sharp edges.

Although incorrect camber (or incorrect adjustment of the suspension) leads to significant shortening of the lifetime of tires, the damage is less serious than that resulting from an alignment fault.

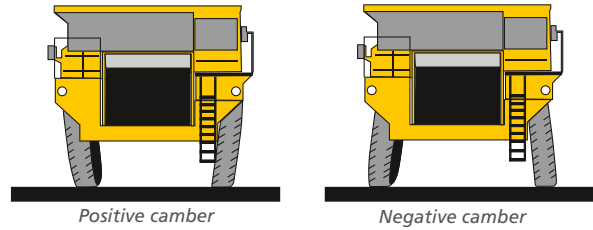

Weighing a rigid dumper











Weighing scales installed

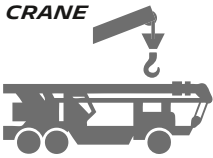

Machine being weighed

Examples of possible adjustments for each type of machine

MACHINE	AXLE	ALIGNMENT	CAMBER	SUSPENSION (STIFFNESS)	NOTES
LOADER 	All positions				
FORKLIFT TRUCK 	All positions	*			* Except the front, non-steering axle
SCRAPER 	All positions				
TRUCK CRANE AND ALL-TERRAIN CRANE 	All positions	*			Adjustment of the axle alignment generally possible * except for non-steering axles
GRADER 	Front				A command is used to adjust the axle camber to compensate for the deviation caused by the work of the blade
	Rear				
REACH STACKER 	All positions	*			* Except the front, non-steering axle
STRADDLE CARRIER 	All positions			*	* possible, with hydropneumatic suspension
ARTICULATED DUMPER 	All positions			*	* possible, with hydropneumatic suspension
RIGID DUMPER 	All positions	*			* except the rear, non-steering axle

■ Easy adjustment
 ■ Adjustment requiring return to the workshop and a longer time out of service
 ■ Adjustment impossible

INSPECTING TIRES ON VEHICLES

90 INTRODUCTION

91 PRELIMINARY PRECAUTIONS

92 PROCEDURE

94 POINTS TO CHECK



INSPECTING TIRES ON VEHICLES

Inspecting the tires should be part of the regular inspection of machines. It is one of the major aspects of such an inspection.

Vehicles that are out of action due to unscheduled stoppages lead to loss of production and result in significant costs.

The best way to avoid such incidents is to check the condition of vehicles and to routinely examine the tires, wheels and accessories associated with inflation (valves, valve caps, inflation extensions, etc.) as part of this check.

This inspection must be carried out in accordance with the safety rules. Its relevance and effectiveness are dependent on compliance with the recommended procedure.

THIS INSPECTION CONSISTS OF:

- locating any damage or initial stages of damage so that the tires can be repaired while there is still time;
- assessing the wear on the tires in order to plan any necessary work (rotation, repair, regrooving, retreading, etc.);
- deciding to demount the tire if it is considered to be worn out or dangerous;
- detecting incorrect adjustment of the vehicle's wheel geometry (alignment, camber, etc.) by observing the nature of the wear;
- and always checking the inflation pressure before setting off again.

Each of these points is covered in this chapter.

Preliminary precautions



Locating damage or initial stages of damage

Technician safety: do not forget anything!

All technicians carrying out vehicle inspections must wear the following personal protection equipment:

- a hard hat;
- protective glasses;
- a vest or safety jacket with reflective strips;
- gloves;
- safety boots or shoes.



Personal protection equipment must be worn when inspecting the tires on vehicles

Inspecting tires

Prerequisites:
vehicle not loaded, stationary and parking brakes engaged

- Whatever type of inspection is to be carried out, it is preferable to work around a vehicle that is not loaded.

If it is necessary to work around loaded vehicles (for example for weighing operations), the operators must stand far enough away to be safe from any falling material, in particular when the machine stops or restarts.

- The vehicle inspection must be carried out with the engine off and the parking brakes engaged.

The lock-out/tag-out procedure must be used. If the vehicle does not have a padlock, it is essential that the driver get out of the machine before any work is carried out on the tires.



If there is a safety padlock, it must be locked

During the inspection: beware of blind spots!

Blind spots are potential sources of danger.

The area that cannot be seen increases with the size of the vehicle. It is proportionally larger than the size of the machine would lead you to believe.

When the inspection of the tires on the largest machines (used in mines and quarries) requires them to be moved, the technician has to work outside the operator's field of vision. For this reason, it is preferable to use a team of two technicians:

- the technician carries out the examination;
- the coordinator stands in front of the vehicle all the time, clearly visible to the operator, to inform the operator when the vehicle needs to be moved.

When the inspection has been completed, both technicians stand together on the left of the vehicle (cab side). The coordinator can then inform the driver that the vehicle is ready to leave.

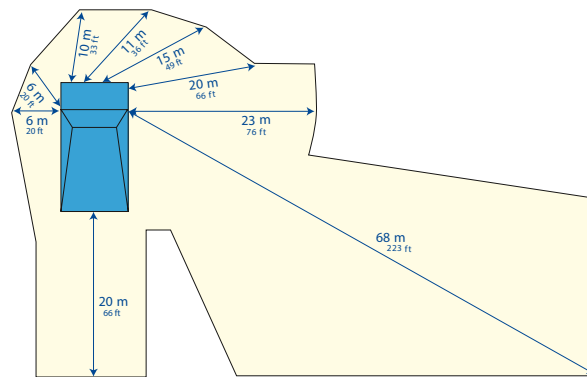

Blind spots around very large dumpers



The vehicle is released, both technicians are standing to the side



The regulations of operating sites generally define the safety protocol to be followed when inspecting vehicles. Strict compliance with this protocol is essential.

Procedure

Essential tools



The vehicle inspection must be carried out with the engine off and the parking brakes engaged

The following equipment is required for inspecting a vehicle:

- flashlight;
- tire chalk;
- measuring tape;
- tread depth gauge;
- calibrated pressure gauge;
- combination pliers;
- spreader pliers;
- probe (or screwdriver for inspecting large tires).

Work around the vehicle: strict compliance with this procedure is important!



Forklift truck with telescopic mast

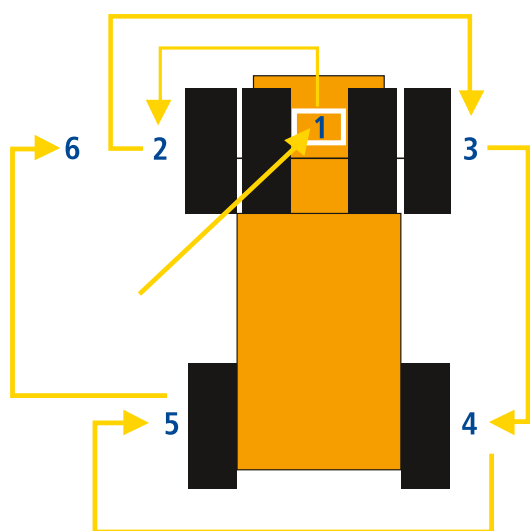

Inspecting the tires on a forklift truck with telescopic mast

To ensure an inspection is thorough, it is divided into three steps which must always be carried out in the order indicated:

Step A:

Ensure the vehicle is safe and identify it. First and foremost, comply with the protocol defined in the internal regulations of the site.

If there is no such protocol, or in addition to the protocol, refer to the recommendations given in the previous section on making the vehicle safe.

① Identify the vehicle (number, license plate, etc.) and read its mileage (or the hour meter) as well as the information available in the cab (check the indicators that monitor the essential functions of the machine).

Step B:

Inspect the tires at the various positions.

Each position is equipped with single- or dual-tire fitments, depending on the vehicle type.

For example:

- a rigid dumper has single-tire fitments at the front and dual-tire fitments at the rear;
- a reach-stacker is the other way around: dual-tire fitments at the front and single-tire fitments at the rear.

The inspection is carried out by walking round the vehicle clockwise. At each position, the wheel (rim + tire) or the dual fitment is inspected closely, not forgetting to look at the suspension components on the opposite side.

② Start by inspecting the left front position;

③ Then the right front;

④ Followed by the right rear;

⑤ And finally the left rear.

Step C:

End of the inspection.

⑥ Check that nothing has been left on the ground around the vehicle

- Move away from the vehicle on the driver's cab side;
- Stand far enough away from the vehicle to be completely visible to the driver;
- Inform the driver that the inspection is complete.



Start with the left front tire, then work around the vehicle

Points to check

On the tire

Step 1: Inspect the outer sidewall and take a note of the serial number of the tire.

Step 2: Check the pressure (finding an incorrect pressure may help with the analysis in the next step).

Step 3: Look at the tread, its appearance, whether or not the wear is even and check for the presence of any damage that may reach the crown plies.

Step 4: Check the tread depth, taking measurements at the center of the tread and on the inner and outer shoulders of the tire.

Step 5: Inspect the tire's inner sidewall.



Check the appearance of the tread

For dual tire units

The inspection protocol is identical to that described previously, starting with the outer tire.

See also the "Duals usage" chapter (in particular: the safety aspects).

To remove an object trapped between the two tires, it is essential to deflate both tires.

It may sometimes be necessary to demount the wheels.



Any object that is trapped between a dual tire unit presents a risk: it may be ejected with considerable force at any time by the pressure exerted by the tires.



Check there are no objects trapped between the tires of a dual tire unit

What should you do with a damaged tire?

The answer to this question depends on how much the tire is worn and the severity of the damage. This is why the inspection must be carried out by a technician trained to do this:

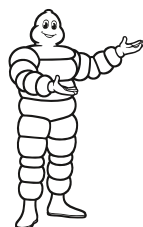

Should you repair a tire with minor damage or leave it in use?

The more expensive the tire is to buy and/or the less worn it is, the more cost-effective it is to carry out a preventive repair.

- serious damage (carcass visible): send immediately for repair if repairable or, if the tire is too worn, scrap it immediately.
- minor damage to rubber (non-visible plies)
 - if the tire has already been used for some time, leave it in use on condition that the damage is inspected regularly: it is always possible that it may worsen gradually or very quickly;
 - if the tire is still relatively new, get a preventive repair carried out (see the "Repairing tires" chapter).

On the wheel

Check:

- that there are no cracks or serious damage of the rim;
- that the wheel nuts are tightened correctly.

Note any traces of oil: they may indicate a leak



Check the wheel

On the vehicle

If the vehicle has rock ejectors, check that they do not rub excessively on the tires' sidewalls. Check their general condition (rock ejectors not bent, sharp edges).



Check the rock ejectors

Check the inflation pressure

Before checking this, remove any dirt from the valve and clean the end of the valve to prevent the inner mechanism (the valve core) from becoming clogged with small stones falling into the valve stem.

To check the inflation pressure, the technician must wear protective glasses and use a calibrated pressure gauge.



Clean the valve before checking the pressure

This operation should ideally be carried out when the tires are cold

Tires are considered to be cold when they are checked after the machine has been stopped for a long time. The larger the tire, the longer the stoppage time required.

If the pressure measured differs from the recommended pressure by more than 10%, it must be corrected as quickly as possible.

If the pressure is abnormally low, test for a leak by covering the suspect areas, in particular the valve and the valve base, with soapy water. Check that the valve cap is in place, in good condition and tightened (by hand). Change it if it is faulty as it ensures the airtightness of the assembly.



The pressure when cold must not differ from the recommended level by more than +/- 10%

If the operation is carried out while the tires are warm

Tires are considered to be warm when they are checked while the vehicle is in use.

The measured pressure must be higher than the pressure recommended for the same tire when cold.

If the vehicle has been used under normal conditions prior to stopping, the difference between the measured pressure and the recommended pressure must be no more than 25% of the recommended pressure.

If the pressure is below the recommended value, look for a possible leak.



Never deflate a warm tire.

Checking the pressures remotely

If tires are fitted with a pressure sensor they can be checked remotely (without having to stop the machine).

MICHELIN® MEMS®4 is a powerful monitoring tool for tires and usage conditions. It combines downtime-fighting features, innovative equipment and seamless connectivity to increase profits and reduce downtime by protecting your people, tires and equipment. (See the «Factors affecting the service life of tires» chapter)



With MEMS, you can check the pressure of the tires remotely without having to stop the machines

Measuring tire wear

This must be carried out at the points specified by the manufacturer.

Beware: the locations may differ from one tread pattern to another.

To obtain an exact assessment of tire wear, the tread depth must be measured at several equidistant tread depth indicators included around the entire circumference of the tread, at both the center and the shoulders.

A widely differing tread depth (difference of more than 10%) between the two sides of the tread may indicate misalignment of the wheel set concerned (see the "Machine inspection" chapter).

Uneven wear on the circumference may be an indication of a mechanical problem.



Measure the remaining tread depth at the indicated locations, in several places

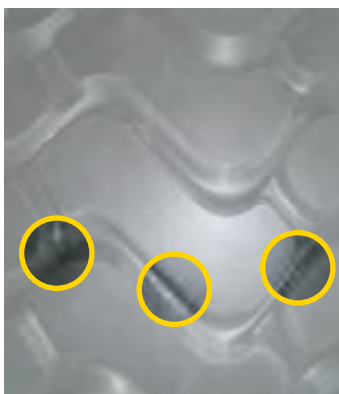

Location of the wear indicators on a MICHELIN® XHA® 2 tire



TIP

Michelin technicians have an in-depth knowledge of the vehicle inspection process.

Contact them if you need their advice.

INSPECTING DEMOUNTED TIRES

98 INTRODUCTION

99 FULL ASSESSMENT AND ACTION
TO BE TAKEN

100 TIRE INSPECTION TOOLS AND PROCEDURE



INSPECTING DEMOUNTED TIRES

It is essential to inspect tires regularly both in terms of safety and in order to reduce operating costs.

Regular careful, detailed inspection of tires when they are swapped over on machines will improve their lifetime.

Tire inspections must follow a rigorous procedure and must be carried out by a technician equipped with the appropriate personal protection equipment.

Depending on the condition of the tires, the possible conclusions are:

- *send the tires for repair or retreading;*
- *select new tires more suitable for the conditions of use;*
- *take steps to improve the operating conditions, to reduce the frequency and severity of damage.*



Full assessment and action to be taken



Inspecting the bead of a mining tire

When should a tire be taken out of use?

Tires must always be demounted when:

- they are worn out;
- they are damaged, as they are a potential hazard for people and equipment.

It is strongly advised to use handling equipment that is appropriate for the size of the tire to demount it from the vehicle.



Take advantage of operations to rotate tires to inspect them

What should you do with the tire after you have inspected it thoroughly?

If the tire is in good condition and has not yet reached its usage limit:

- either remount it on the vehicle;
- or put it into stock.

If the tire is damaged:

- demount it from the rim;
- send it to the repair or retreading workshop;
- scrap it, with possible recycling, in accordance with current local environmental regulations.

What are the causes of damage?

Asking a qualified technician to carry out a thorough inspection of demounted tires often helps to understand what has caused the damage.

If you can identify the cause, you can remedy or lessen its effects by setting up an improvement plan.



So, although it is sometimes inconvenient, systematic inspection of demounted tires is essential for the good management of a stock of tires.

Tire inspection tools and procedure

Handling equipment

Most operations require the use of appropriate handling equipment as a safety precaution.

Use of the following equipment is recommended, depending on the size of the tire and the equipment available on-site:

- a forklift truck;
- a loader;
- a crane fixed on the platform of a truck.

It is preferable to fit the equipment with a tire handler.



Loader equipped with tire handler

Immobilization of the tire during inspection

For safety reasons, the inspection should preferably be carried out with the tire placed horizontally on the ground.

It is, however, possible to carry out an inspection with the tire vertical, as long as it is immobilized to prevent it rolling or falling over.

The blocks used to immobilize the tire must therefore be checked regularly.



Forklift truck equipped with tire handler



Inspection of a tire by a technician



Inspecting the interior of the tire, an essential step



The regulations of operating sites generally define the safety protocol to be followed when inspecting vehicles. Strict compliance with this protocol is essential.



When handling and inspecting tires, always wear personal protection equipment (hard hat, glasses, gloves and safety shoes).

Tools

To carry out an inspection, you need the following equipment:

- flashlight;
- measuring tape;
- tread depth gauge;
- spreader pliers;
- probe (or screwdriver for inspecting large tires);
- tire chalk.



Probe



Spreader pliers

7-step tire inspection procedure

Preliminary step:

In order to be able to inspect all parts of the tire correctly, it must be cleaned before inspection.

At every step, carry out a visual inspection and feel the tire, looking for any distortions, tears, cracks, damage, sharp edges (rough to the touch), etc.

PROCEDURE

- ① Tread and shoulder of the tire, to ascertain its conditions of use.
- ② Exterior of the first sidewall.
- ③ Interior of the opposite sidewall. (up to the center of the tread)
- ④ Bead of the first sidewall.
- ⑤ Exterior of the second sidewall.
- ⑥ Interior of the first sidewall. (up to the center of the tread)
- ⑦ Bead of the opposite sidewall.

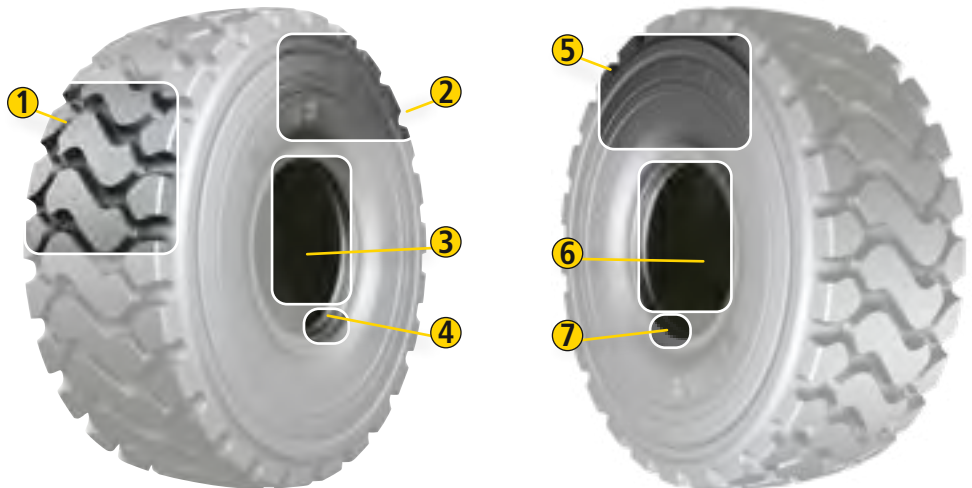

TIP

Michelin technicians can provide you with additional information on request.

Cutting up a tire to inspect it

It may be necessary to cut up a tire to determine the exact origin of damage.



This operation, which can be dangerous, must only be carried out by a qualified technician, equipped with special protection equipment and with the appropriate tools.

REPAIRING TIRES

104 *INTRODUCTION*

105 *ORGANIZATION
OF THE REPAIR WORKSHOP*

106 *REPAIR METHODS*



REPAIR

The harsh conditions in which earthmover tires are used often cause slight, and occasionally serious, damage.

MICHELIN® Earthmover tires can, under certain conditions, be repaired: this possibility is built in at the design stage.

Repairing a tire is a matter for professionals. The repairer is always solely responsible for the quality of the work on the tire.

ADVANTAGES

Real savings and protection of the environment

Repairing a tire extends its life. If it were not repaired, it would be scrapped.

Two important consequences:

- considerable savings made on tire expenditure;
- helping to protect the environment by delaying scrapping.

Organization of the repair workshop



Equipment layout

It must:

- ensure optimum productivity and safety by limiting how much operators have to move around, by optimizing intermediate stock and also by the choice of lighting, ventilation, etc.
- enable the area to be organized into two separate flows to avoid any risk of contamination of tires while they are being repaired:
 - incoming material flow: cleaned casings, repair products
 - ← outgoing material flow: repaired tires, waste materials

Organization of the workshop: safety and efficiency

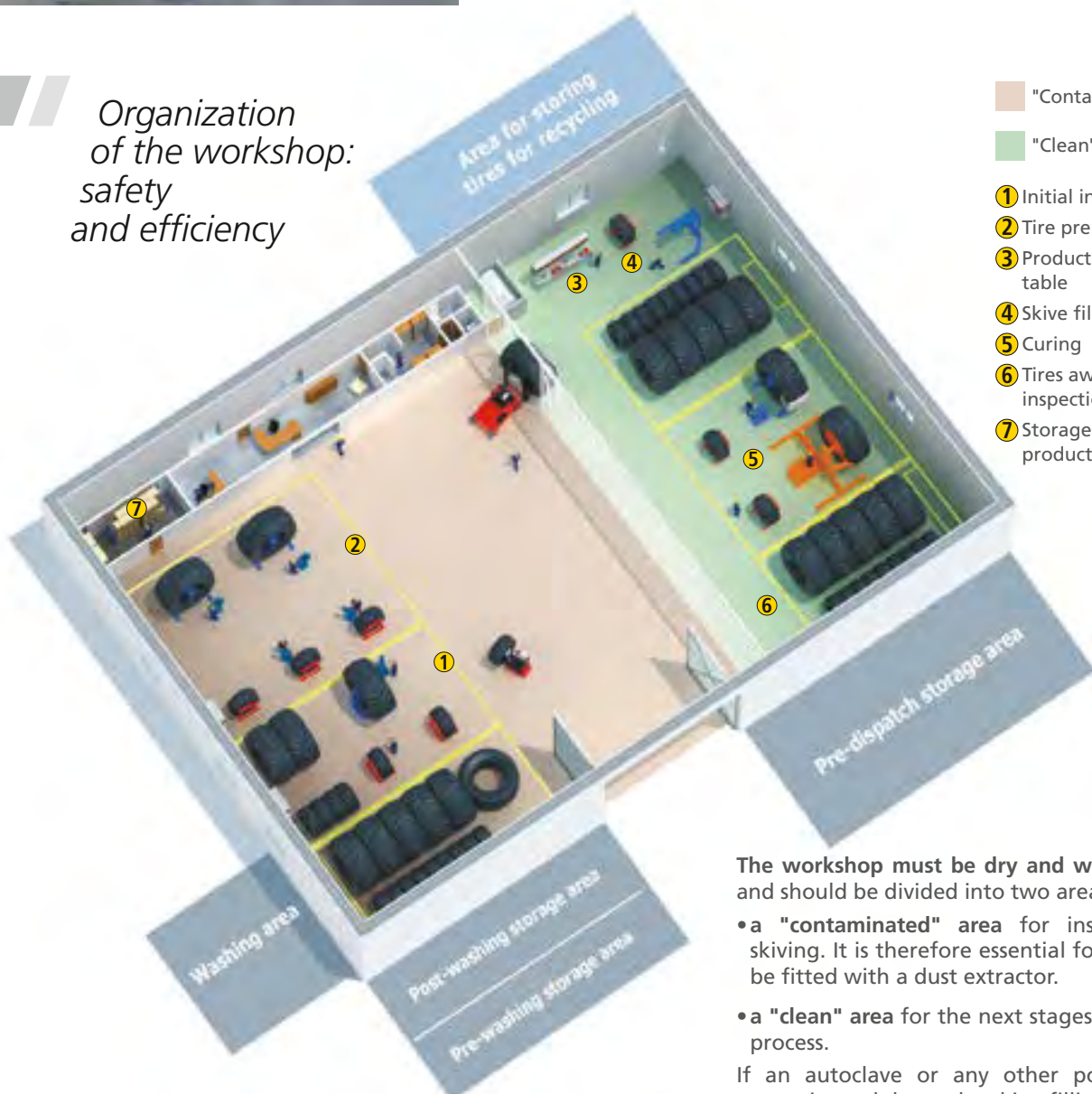

■ "Contaminated" area

■ "Clean" area

- ① Initial inspection
- ② Tire preparation
- ③ Product preparation table
- ④ Skive filling
- ⑤ Curing
- ⑥ Tires awaiting final inspection
- ⑦ Storage of repair products

The workshop must be dry and well-ventilated and should be divided into two areas:

- a "contaminated" area for inspecting and skiving. It is therefore essential for this area to be fitted with a dust extractor.
- a "clean" area for the next stages in the repair process.

If an autoclave or any other powerful heat source is used, keep the skive filling and curing areas separate.

Repair methods



Cold cure repair or hot cure repair: which products should you use?

The following items are required for repairing a tire:

- filler rubber to fill in the damage;
- bonding rubber to provide a good bond between the repair products and the repaired tire;
- patches and repair pieces of the right sizes for the damage. These are used to strengthen the structure of the tire and restore the air-tightness of the casing;
- Mushroom-shape pieces, specifically used to plug any perforation-type damage;
- rubber solution products to promote adhesion between the various products.

Repairs are carried out using the "cold cure" or "hot cure" process.

Each of these processes involves the use of specific products, which are not compatible for use in the other process or at the same time (mixing of rubbers for example).

The "cold cure" or self-curing repair process does not require any external heat source other than that of the surrounding environment (as long as the temperature is 64°F • 18°C or more).

The "hot cure" repair process requires the addition of external heat to cure the rubber and create the bonds between the various components. The products must be suitable for the equipment used, and it is essential to keep strictly to the recommended temperatures.

▶▶▶▶▶ **Only use products that are compatible with one another. The best approach is therefore to use products from the same manufacturer.**

• **Ensure patches are applied the right way up and facing the right direction.**



Before repair



After repair

Considerations for repair

• Examine the damage: feasibility of repair

The type of damage, its position on the tire and its proximity to other damage will determine the feasibility of carrying out a repair.

The patches to be used will vary according to the size of the damage.

• Size of the damage: reparability of the tire

The size of the damage, defining the dimensions of the repair, will determine the reparability of the tire and, if it is repairable, the materials and products to use.

• Repair dimensions: a determining factor in the choice of patches

They must always be measured after preparation of the tire.

▶▶▶▶▶ *The time it takes for the repaired area to cure depends on the process used (temperature, pressure), the characteristics of the products used and their thickness. If no indication is given, contact the supplier of the products concerned.*

Tools

● For checking

- flashlight;
- spreader pliers;
- cutting pliers;
- grease chalk or indelible marker;
- tape measure.

● For skiving

- high-speed air grinder (for cords);
- low-speed air grinder (for rubber);
- set of suitable skiving/milling cutters and grinding wheels.

● For repairing

- knife;
- scissors;
- roller.

● For curing the repair: the tools required depend on the method used.



Demounting is essential: all tires **MUST** be deflated, demounted and removed from their rims before carrying out any repair operations.

▶▶▶▶▶ **Secure the tire:** before starting any work, the tire must be firmly fixed to prevent it from rolling or falling over. Check that tires are securely fixed: after every handling operation and periodically during repair.



Curing with a thermopress



Curing in autoclave

Stages in the repair process



Initial inspection

1 Initial inspection: can the tire be repaired?

A tire can be repaired if:

- the damage is located on a repairable part of the tire (see the "Inspecting tires" chapter);
- the size of the damage is within the reparability dimensions defined by the manufacturers of the repair products;
- there is no other damage too close to the damage under consideration.



Tire preparation

2 Tire preparation: cleaning the damage

Purpose: to remove damaged cords and any cut rubber.

This is carried out on the inside and the outside of the tire, in and around the damaged area.

After preparation of the damage, prepare the area for the application of the repair products (shape, grain, etc.).



Checking and measurements

3 Checking: after preparation, is the tire still repairable?

Final check to decide on the reparability of the tire:

measure the dimensions of the damage to check that they are still within the maximum limits given by the manufacturers of the repair products.



Application of rubber solution

4 Dust removal and application of rubber solution

Dust is removed from the prepared area, then a rubber solution (mixture of rubber + solvent) is applied.



Preparation of the repair products

5 Preparation of the repair products

- The repair products must be chosen according to:
- the repair method used;
 - the dimensions of the damage.

They are prepared and adjusted to the size of the damage.



Application

6 Application

The patch (or mushroom-shape piece) is put in position then rolled onto the inner surface of the tire.

If necessary, rubber repair solution is applied to the outer surface of the damage.

Follow the manufacturer's application instructions printed on the patch (direction of application).



Curing using sectional press

7 Curing: cold cure or hot cure

Depending on the method chosen, the curing is carried out:

- cold, at ambient temperature;
- hot, in an oven, an autoclave or by sectional heating or by heating a specific sector; the materials must be able to maintain pressure on the patch and rubber.



Protection of operators

At every stage in the operation (from handling tires through to their repair), the operator must wear personal protection equipment: safety shoes, gloves, glasses, a mask and ear protection.



Never repair tires with the following types of damage:

- exposed or deformed bead wire;
- damage by greasy substances, solvents or corrosive products;
- damage outside the repair areas indicated by the manufacturer and/or outside the limits given by the manufacturer of the repair products.

REGROOVING

15

112 *INTRODUCTION*

113 *REGROOVING AND SIPING*

114 *GENERAL PRINCIPLES*

115 *REGROOVING AND SIPING GUIDELINES*

A close-up photograph of a tire tread being regrooved. A metal blade is cutting a new groove into the worn rubber. The background is dark and textured, showing the tire's surface and the machine's components.

REGROOVING

Regrooving consists of removing some of the remaining rubber from the tread of a tire which has become worn in order to recreate the original tread patterns and thus extend its operational life.

While this is carried out routinely on truck tires, regrooving of earthmover tires is only possible on tires intended for use on truck cranes. They are marked "regroovable" on their sidewalls.

Regrooving is recognized by the international standards (R 54 regulations in the EC and FMVSS 119 in the U.S.).

It **MUST** be done by qualified technicians, in accordance with clearly defined procedures.

It must comply with the current regulations in the country in which the regrooved tire is to be used.

These regulations generally define the minimum tread depths when worn tires are removed from service and the restrictions on mounting regrooved tires on the various axles.

Regrooving and siping

Definitions

Siping and regrooving

- either removing the bridges linking the tread blocks in order to improve traction.
This operation is carried out when there is 0.20 in (5 mm) of tread remaining for wear.

- or cutting the groove base down to the depth given by the regroove depth indicator. The regrooving consists to extend the life of the tire.
This operation is carried out when there is #0.10 in (# 2 à 3 mm) of tread remaining for wear.

Regrooving can only be carried out on truck crane tires; for example, MICHELIN® XGC® and MICHELIN® X-CRANE® or X-CRANE® + tires.

The aim is to reproduce the tire's original tread pattern.

Siping

Siping consists of making cuts in a tire tread without removing any material to improve grip.



**Tires designed to be regrooved are marked "Regroovable" on their sidewalls (R 54 and FMVSS 119 regulations).
If this is not marked on the tire, then the tire is not regroovable.**



Benefits of regrooving

- As the tread pattern is partially restored, it significantly extends the lifetime of the tire (by up to 20%) and restores adhesion.
- It enables the tire to be used to its maximum potential and helps in particular to reduce its operating cost: improving mileage at a time in the tire's life when its rolling resistance is at its lowest.



Regrooving extends the life of the tire

Limitations

It is not advisable to regroove a tire if:

- the tread shows significant signs of damage: punctures, large numbers of cuts, pieces of tread pattern torn off, oxidation and corrosion of the plies, etc.;
- when inspected, the metal crown plies are visible or cuts can be seen on them;
- tires are over 10 years old.



First 2 digits = month; last 2 digits = year

General principles

Only tires with sufficient rubber available can be regrooved!

To ensure that regrooving will not adversely affect their solidity or strength, regroovable tires are designed with an additional thickness of rubber between the groove base and the crown plies.

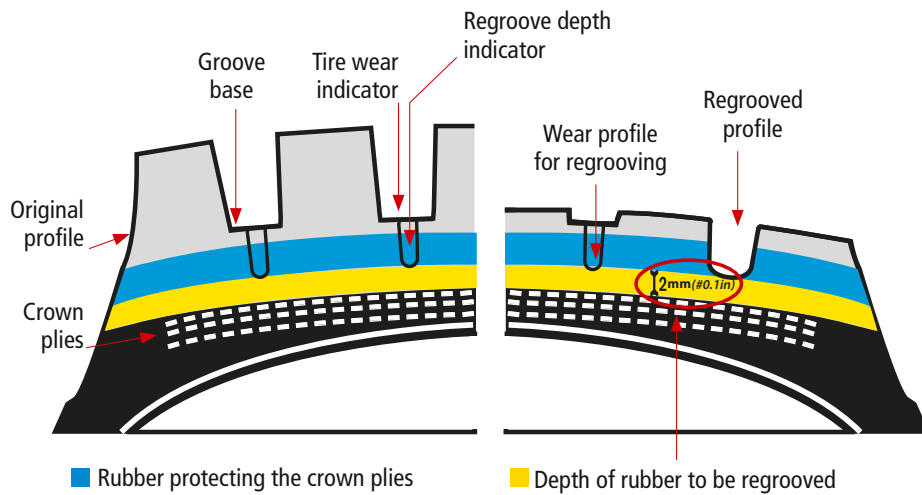

Precautions to be taken

- Before regrooving, the tire must be placed on a support fitted with a non-return ratchet, which both holds it in position (to prevent any risk of its toppling over) and allows it to be rotated as the regrooving is carried out.
- Personal protection equipment must be worn to ensure safety during regrooving: protective glasses, gloves and safety shoes.



Tire regrooving should preferably be done after tire removal from the vehicle. However, the tire does not need to be demounted from the rim, but it is recommended to reduce the tire pressure to 2 bar for security reasons.



Never regroove a tire that is more than 10 years old

How to regroove a tire

Use the right equipment:

- a portable transformer;
- a blade holder;
- removable blades.



- ① Blade holder ② Removable blades ③ Regrooving gauge

Set the blade to a regrooving depth that will enable an adequate thickness of rubber to be retained to protect the crown plies.

0.1 to 0.2 in (3 to 5 mm) cutting width	0.2 to 0.4 in (5 to 11 mm) cutting width	0.2 to 0.5 in (7 to 13 mm) cutting width	0.4 to 0.6 in (9 to 16 mm) cutting width	0.4 to 0.7 in (11 to 18 mm) cutting width
---	--	--	--	---

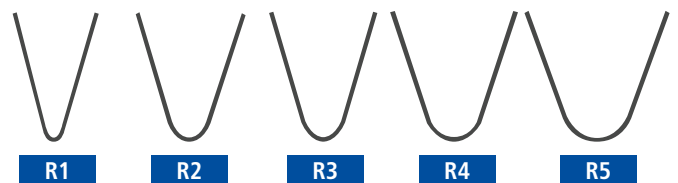

Only "R3"-type rounded blades are generally used for earthmover tires.

Regrooving dimensions and setting the blade

A regroove depth indicator, located in the groove base, is used to measure the height of the remaining rubber. This measurement is used to set the height of the blade, so as to leave at least 0.10 in (2 mm) of rubber protecting the crown plies.

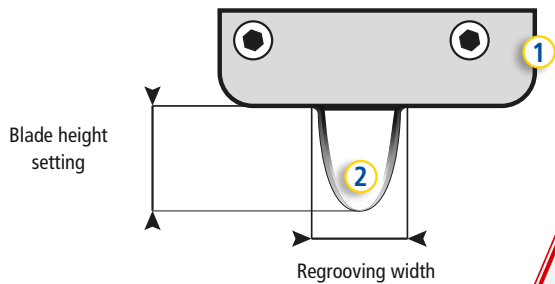

① Blade holder ② Removable blades



Regrooving blade holder



Regrooving too deeply may cause damage or expose the metal crown plies in the groove base, which will lead to immediate scrapping of the tire.

Regrooving and siping guidelines

Regrooving and siping guidelines for the MICHELIN® XGC® tire

Improving traction by siping

- Remove the crosswise bridges (in the center, shown in blue) and those on the shoulders (on the sides, shown in blue), down to the groove base.
- Only remove the bridges linking the tread blocks.

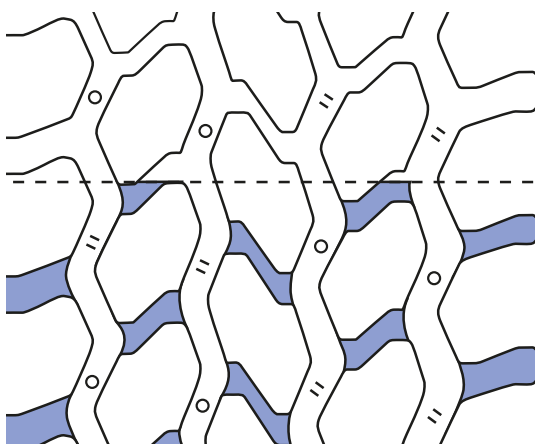

Tire wear indicator

Improving tire service life: regrooving

Carry out lengthwise regrooving (grooves) down to a depth corresponding to that measured at the regroove depth indicator.

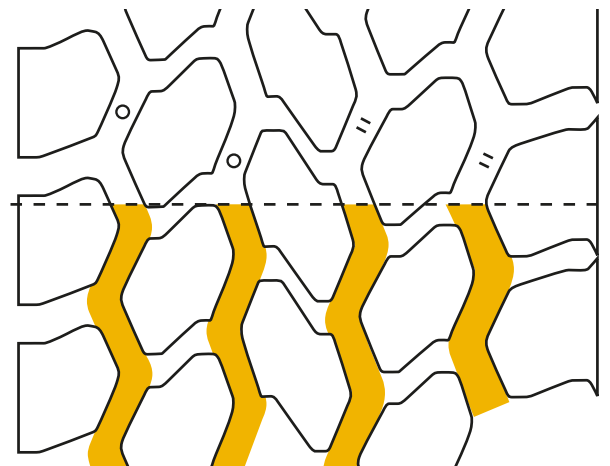

Regroove depth indicator

- = Crosswise siping
- Lengthwise regrooving

Improving traction: transversal grip

- Remove the bridges on the shoulders (shown in blue) down to the groove base.
- Only remove the bridges linking the tread blocks on the shoulders.

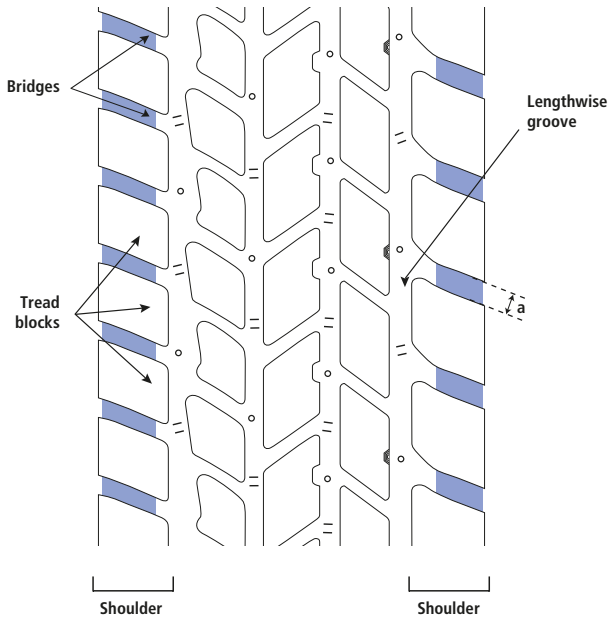

(a) Width of the bridges on the shoulders



MICHELIN® X-CRANE®: regroove depth indicator (at the top), tire wear indicator (at the bottom)

Improving tire traction: regrooving

Carry out lengthwise regrooving (grooves) and crosswise regrooving (center and shoulder bridges) down to a depth corresponding to that measured at the regroove depth indicator.

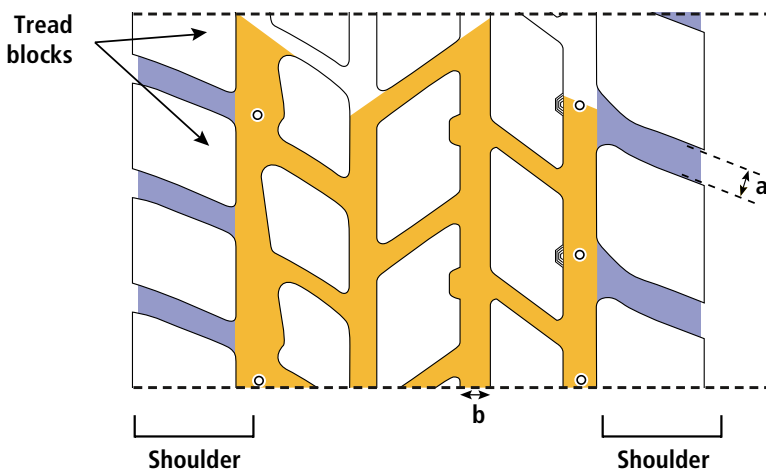

MICHELIN® X-CRANE® with the bridges on the shoulders and the lengthwise grooves in the center regrooved (bridges in the center and outer lengthwise grooves not regrooved)

- Lengthwise regrooving
- (a) Width of the bridges on the shoulders
- (b) Cutting width = original width of the groove

To find out which tread patterns are regroovable and the appropriate dimensions, refer to the regrooving guidelines available at www.earthmover.com.



Michelin has published specific documentation on regrooving earthmover tires. Michelin technicians can provide you with this on request.

Siping: an operation specific to earthmover tires

Siping is principally carried out in order to improve performance in wintry conditions and to increase safety. It can only be done on certain types of tire, one of which is the MICHELIN® X TERMINAL-T®.



Siping guidelines for the MICHELIN® X TERMINAL-T® tire

Make parallel cuts in the crosswise grooves (without removing rubber) to a depth measured at the level of the tire wear indicators (1.2 in - 30 mm for a new tire) and spaced 0.2 in (5 mm) apart.

These cuts must be at the same angle as the initial tread pattern and evenly distributed over the whole surface of the tread.

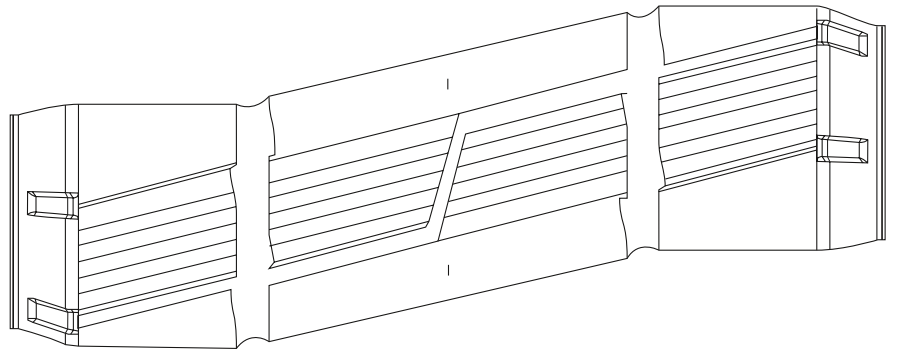

TIP

Michelin technicians can, on request, advise you.

RETREADING TIRES

120 INTRODUCTION

*121 RETREADING,
A COMPLEX INDUSTRIAL PROCESS*

121 ORGANIZATION OF THE WORKSHOP

*122 UNCURED RUBBER
OR PRE-MOLDED TREADS...
THE DIFFERENCE IS IN THE BUILDING
AND CURING!*

123 RETREADABILITY CONDITIONS

*124 CURING,
AN IMPORTANT STAGE IN RETREADING*

125 PERFORMANCE AND ECONOMIC BENEFIT

126 STAGES IN THE RETREADING PROCESS



RETREADING ***A "second life"*** ***for your tires?***

Retreading a tire consists of removing the worn tread and replacing it with a new one.

The performance of a retreaded tire can be very similar to that of an equivalent new tire. This is why it is often said that retreading gives a tire a "second life."

Retreading worn tires also can help to:

- reduce vehicle operating costs;
- protect the environment (lower consumption of new tires, scrapping of the casing is postponed).

Incorporating retreading as a factor in tire stock management requires the implementation of good practices designed to maintain the retreadability of the casings, right from the start of the "first life" of the tires.

Earthmover tires must only be retreaded by retreading professionals, who have an in-depth knowledge of the techniques specific to this type of tire.



Retreading, a complex industrial process



Retreading workshop

Whichever process is used, the tire being retreaded passes through the following stages:

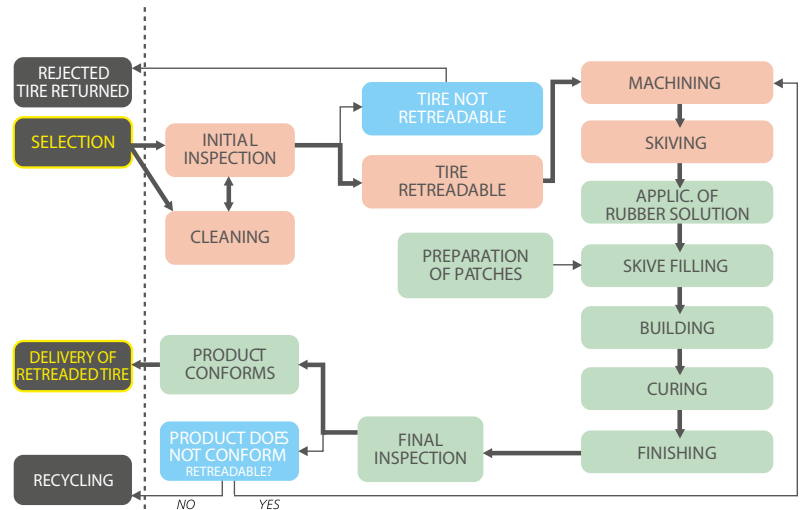

Stages in the retreading process

Organization of the workshop



- Contaminated area
- Clean area

- 1 Storage of tires for retreading
- 2 Initial inspection
- 3 Machining
- 4 Skiving
- 5 Application of rubber solution
- 6 Skive filling
- 7 Building
- 8 Preparation table
- 9 Autoclave (pre-curing)
- 10 Presses (hot curing)
- 11 Tires awaiting finishing
- 12 Finishing and final inspection
- 13 Retreaded tires awaiting dispatch
- 14 Storage of repair products
- 15 Storage of retreading products
- 16 Storage of molds
- 17 Power plant

Uncured rubber or pre-molded treads... the difference is in the building and curing!

Depending on the process chosen, uncured rubber or pre-molded treads is used. The difference between these two types of retreading is principally at the building and curing stages.

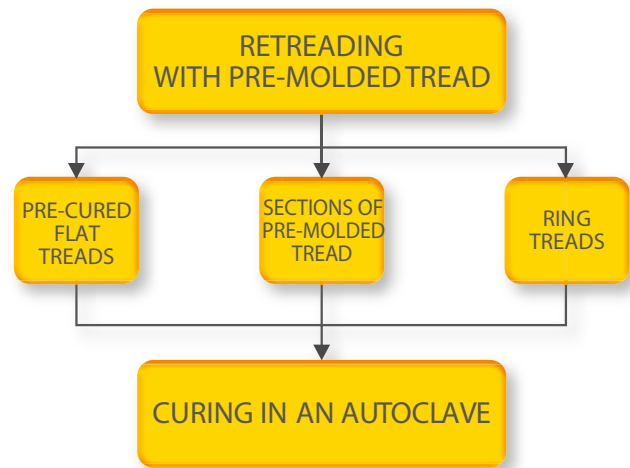
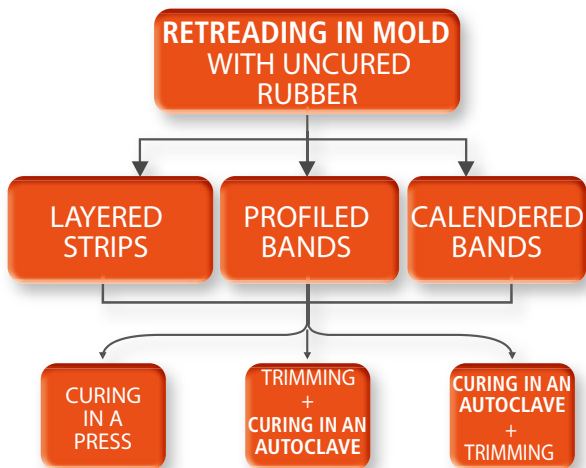

Whichever process is used, it is not advisable to retread earthmover tires that are more than 10 years old.



Applying layered strips

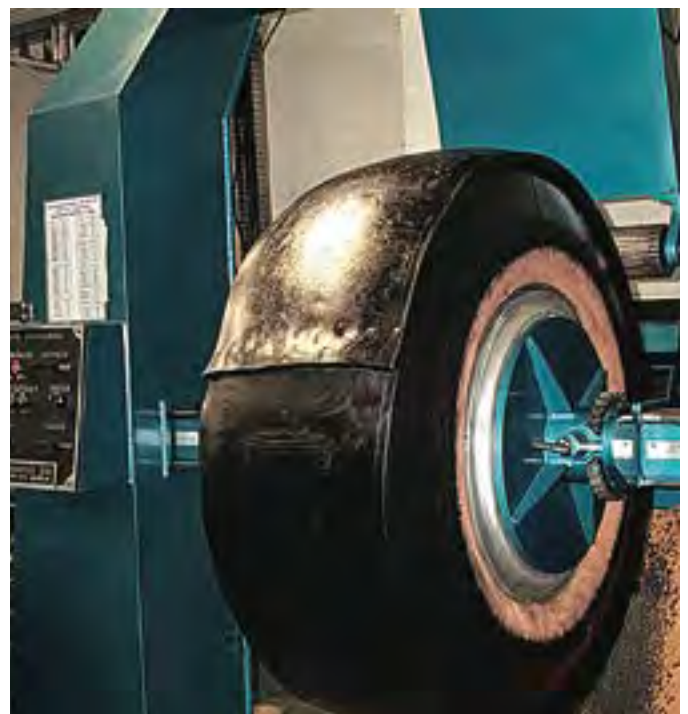

Applying a calendered band

Retreadability conditions

First condition: "the tire must be designed for retreading"!

For a tire to be retreadable, this possibility must have been incorporated right from the design stage.

Most earthmover tires are retreadable. There are however a few exceptions, generally connected with the conditions of use of these tires.



MICHELIN® XGC® and MICHELIN® X-CRANE® tires for use on truck cranes cannot be retreaded.



The giant tires mounted on rigid dump trucks used on mining sites can only be retreaded after an in-depth initial inspection which includes non-destructive testing (shearography, scanning, ultrasonic tests, etc.).



TIP

Michelin technicians can provide you with information on the retreadability of all MICHELIN® earthmover tires.

Second condition: a tire with no major damage at the end of its "first life"

A worn tire can only be retreaded if it has not suffered any irreparable damage: running flat, heat buildup, overloading, underinflation, damage outside the repair limits, pollution by chemicals, etc.

This is why, if you want to be able to retread tires, you must pay particular attention to their conditions of use throughout their "first life."



An earthmover tire can generally only be retreaded twice.

Third condition: agree to slightly shortening the tire's "first life"

Retreading an earthmover tire involves withdrawing it from use a little earlier (when there is still approximately 10% of the original tread depth remaining).

This is necessary for subsequent good quality retreading.



A tire that is too worn cannot be retreaded

Fourth condition: retread with a similar tread pattern to that of the new tire

The architectures of MICHELIN® tires have been developed to provide the best possible performance for a given use.

This is why it is preferable to retread a MICHELIN tire with a similar tread pattern to the original one and to use the retreaded tire for the same purpose as the original tire.



Inspect the tires on-site before sending them for retreading.

To reduce the risk of the casing being rejected at the initial inspection on entering the retreading workshop, it is advisable to carry out a detailed inspection of the worn tire on-site, before dispatch.

Curing, an important stage in retreading

The curing process differs according to the type of retreading being carried out:

Curing in a press

Pressure is applied in a curing chamber placed inside the tire and inflated with hot water or pressurized air.

The temperature is produced by steam or by electric heating elements.

This type of curing enables simultaneous curing and molding of the uncured mixings to create the tread pattern.



Curing in a press

Curing in an autoclave

The pressure and temperature are produced directly by the autoclave, which is heated by steam.

There are two options:

- with an uncured mixing (profile or strip), a trimming operation is carried out before or after curing to create the tread pattern;
- with a cured mixing (pre-molded tread), curing merely cures the bonding rubber applied between the casing and the pre-molded tread.



Curing in an autoclave

CURING	ADVANTAGES	DISADVANTAGES
In a press Uncured rubber	<ul style="list-style-type: none"> • Better appearance • Longer service life of the retreaded tire • Lower cost (large batches) 	<ul style="list-style-type: none"> • High capital cost (press + molds) • Limited choice of tread patterns (associated with the capital costs of molds) • Periodic maintenance of the molds
In an autoclave Uncured rubber	<ul style="list-style-type: none"> • Simultaneous curing of several repaired and/or retreaded tires • Lower capital cost (vs. press) 	<ul style="list-style-type: none"> • Labor-intensive (trimming) • Appearance of retreaded tire not as good
In an autoclave Pre-molded treads	<ul style="list-style-type: none"> • Wider choice of tread patterns • Capital cost • Lower cost (small batches) 	<ul style="list-style-type: none"> • Joints on tread • Less choice of sizes

Curing protocol or how to control three important parameters

There are three essential parameters for curing, which make up what is commonly known as the "curing protocol."

- Pressure: essential for bonding the interfaces (avoiding the formation of bubbles), penetration of the rubber in the cord plies and molding;
- Temperature: necessary for curing (and changing the state of) the uncured products;
- Curing time: allows the thermal and mechanical effects to reach their maximum effectiveness.



The curing protocol varies according to the retreading process used, the type of curing selected and the size of the tire.



As Michelin does not directly retread its earthmover tires, no express or implied warranty is given concerning the performance of its retreaded tires.

Performance and economic benefit

For the user who owns the retreaded tire

Factors affecting the service life of a retreaded tire

The service life depends on:

- the quality of the new tire and, in particular, the service life of the casing;
- the operating conditions during the tire's "first life";
- the care taken with the selection of the casings at the end of their "first life";
- the expertise of the technicians responsible for the various stages in the retreading process;
- the quality of the retreading equipment and that of the products used.

Economic benefit of retreading

This is assessed by taking the following factors into account:

- the price charged by the retreader;
- the usage time of the tire's two cycles (new + retreaded), known as the "Performance of the tire's two lives";
- a combination of the two preceding factors: comparison of the hourly cost of the new tire used over one "life cycle" with the hourly cost of the same tire used over two cycles (two lives: new + retreaded).

New tire used up to its wear limit	
Purchase price of the new tire	A
Tread depth of the new tire (in mm or inches)	B
Cost per mm/inches of tread (new).....	$C = A/B$

New tire used then retreaded	
Purchase price of the new tire.....	A
Tread depth of the new tire (in mm or inches)	B
Remaining tread when withdrawn for retreading....	$D = 10\% \times B$
Cost of retreading (including logistics costs).....	E
Tread depth of the retreaded tire (in mm or inches).	F
Total tread depth used (new+retreaded).....	$G = B - D + F$
Cost of mounting/demounting tire	H
Cost per mm/inches of tread (new+retreaded)	$(A + E + H) / G$

Comparison of the cost of using a new tire with that of a new+retreaded tire

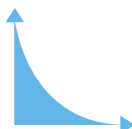

Economic benefit for the retreader

This depends on the industrial performance of the workshop, which includes the following aspects:

- the logistics cost of collecting the casing and returning it to the customer;
- organization of the workshop;
- performance of the retreading equipment;
- expertise of the operators and compliance with procedures;
- the "manufacturing cost" associated with operator performance;
- the "material cost" (repair + retreading): quality of the materials used, thickness of rubber applied;
- the price of the retreading service, which is directly linked to its quality, and thus to the professionalism of the retreader.



The quality of the retreading carried out is dependent on the expertise of the operators

Stages in the retreading process



Initial inspection

1 Initial inspection: is the tire retreadable?

It is generally necessary to wash the casing before inspecting it. The initial inspection consists of:

- as a matter of routine, an in-depth examination: carry out a visual inspection and feel the casing (see the "Inspecting demounted tires" chapter);
- if necessary, additional non-destructive testing: ultrasonic tests, shearography, scanning, X-rays.



Machining

2 Machining: expose the casing

The purpose of this is to:

- remove the remainder of the tread;
- give the crown and shoulders of the casing the appropriate profile for retreading;
- give the machined surface the required roughness so that the products used bond correctly with the casing during retreading.



Skiving

3 Repair: clean any damaged areas on the casing and repair them

This comprises the following stages:

- **skiving**: removal of any unwanted items (embedded stones, etc.) by brushing, cleaning any damage affecting the tire rubber or the casing cords, whether these are on the crown, the sidewalls, the lower part or inside the tire;
- **removal of dust** from the machined and skived casing;
- **application of rubber solution**: spraying a curing solution onto the damaged areas which have been brushed and cleaned;
- **skive filling**: application of filler rubber, bonding rubber, patches, repair pieces and spot repairs in accordance with the procedures established by the product manufacturers themselves.

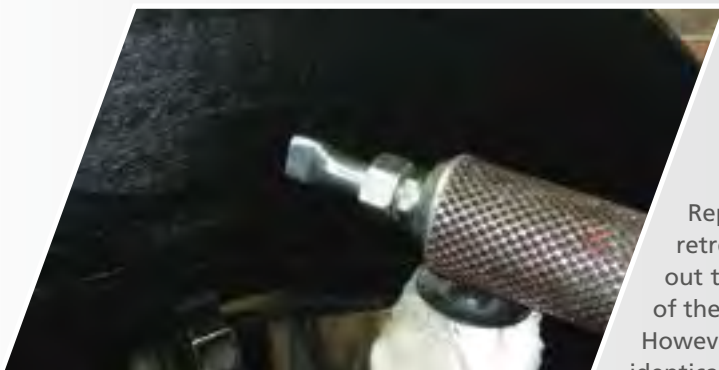

Skive filling

Repairs carried out in the context of preparing a casing for retreading are generally on a smaller scale than those carried out to deal with damage which occurs during the lifetime of the tire.

However, the technique, tools and repair products used are identical (see the "Tire repair" chapter).



Building with a layered strip

4 Building: choose between uncured rubber and pre-molded treads

The procedure varies according to the process and products used:

- Uncured rubber: use of layered strips, profiled or calendered bands;
- Pre-molded treads: use of pre-cured flat treads, sections of tread or ring treads.



Curing

5 Curing: giving the tire a new lease on life

Its purpose is to:

- ensure the internal cohesion of the components (i.e., that the various components bond together);
- cure the uncured mixings (bonding, retreading and repair rubber), resulting in an irreversible bond between the casing and the various products added to it;
- and, for retreading in a press, molding the rubber in order to create the tread pattern.



Final inspection

6 Finishing and final inspection: final stages before the tire is put back into operation

The purpose of these is to check the external and internal visual appearance of the tire, paying particular attention to the repair of damaged areas and, for pre-cure retreading, the appearance of the joints.

A blemish or non-conforming repairs will entail repetition of all or part of the retreading cycle.



Never retread casings with the following types of damage:

- exposed or deformed bead wire;
- damage by greasy substances, solvents or corrosive products;
- damage outside the repair areas indicated by the manufacturer and/or outside the limits given by the manufacturer of the repair products.



Protection of operators

At every stage in the operation (from handling the tires through to their retreading), operators must wear personal protection equipment: safety shoes, gloves, glasses, a mask and ear protection.

REMOVAL DUE TO WEAR AND RECOVERY OF USED TIRES

130 INTRODUCTION

*131 REMOVAL DUE TO WEAR
AND RECOVERY OF USED TIRES*

UPDATE PAGE NUMBERS



REMOVAL DUE TO WEAR AND RECOVERY OF USED TIRES

As end of life subject to regulations...

SAE standard J2611 "Off-Road Tire Conditions Removal Guidelines" defines the conditions for removing tires from service at the end of life. Michelin recommends following these guidelines and underlines that, apart from a few special cases... the owner of a tire is solely responsible for the decision to keep a tire in use or remove it from service.

It can also be a good idea to remove tires from use early in order to repair or even retread them before returning them to service.

In many countries most, if not all, used tires are now recovered: second-hand tires, retreading, energy recovery and recycling of materials.

Depending on their size, earthmover tires can be processed by the recovery systems used for private vehicle, van and truck tires. However, their recycling requires larger and more powerful grinding installations than those used for other types of tire.

Removal due to wear



What criteria should you use for deciding to remove a tire from service?

In view of the huge variety of earthmover tires and their uses, it is impossible to give any rule other than the obvious facts: a worn tire is one that has no visible tread pattern left, or for those that are designed to be smooth, tires on which the remaining rubber is not thick enough to protect them against damage.

It may be necessary to remove a tire from service early:

- Temporarily, for it to be repaired or retreaded (see the «Repairing tires» and «Retreading tires» chapters).
- Permanently, in the event of abnormal wear across or around the tire, generally caused by incorrect adjustment of machines (see the «Vehicle inspection» chapter) or by their conditions of use (see the «Factors affecting the lifetime of tires» chapter).

Conversely, some specific conditions of use may occasionally enable the lifetime of tires to be extended, even after there is no pattern left on the tread. In this case, tires must be inspected at regular, frequent intervals (see the «Inspecting tires on vehicles» chapter).



Remove the tire when there is no tread pattern left

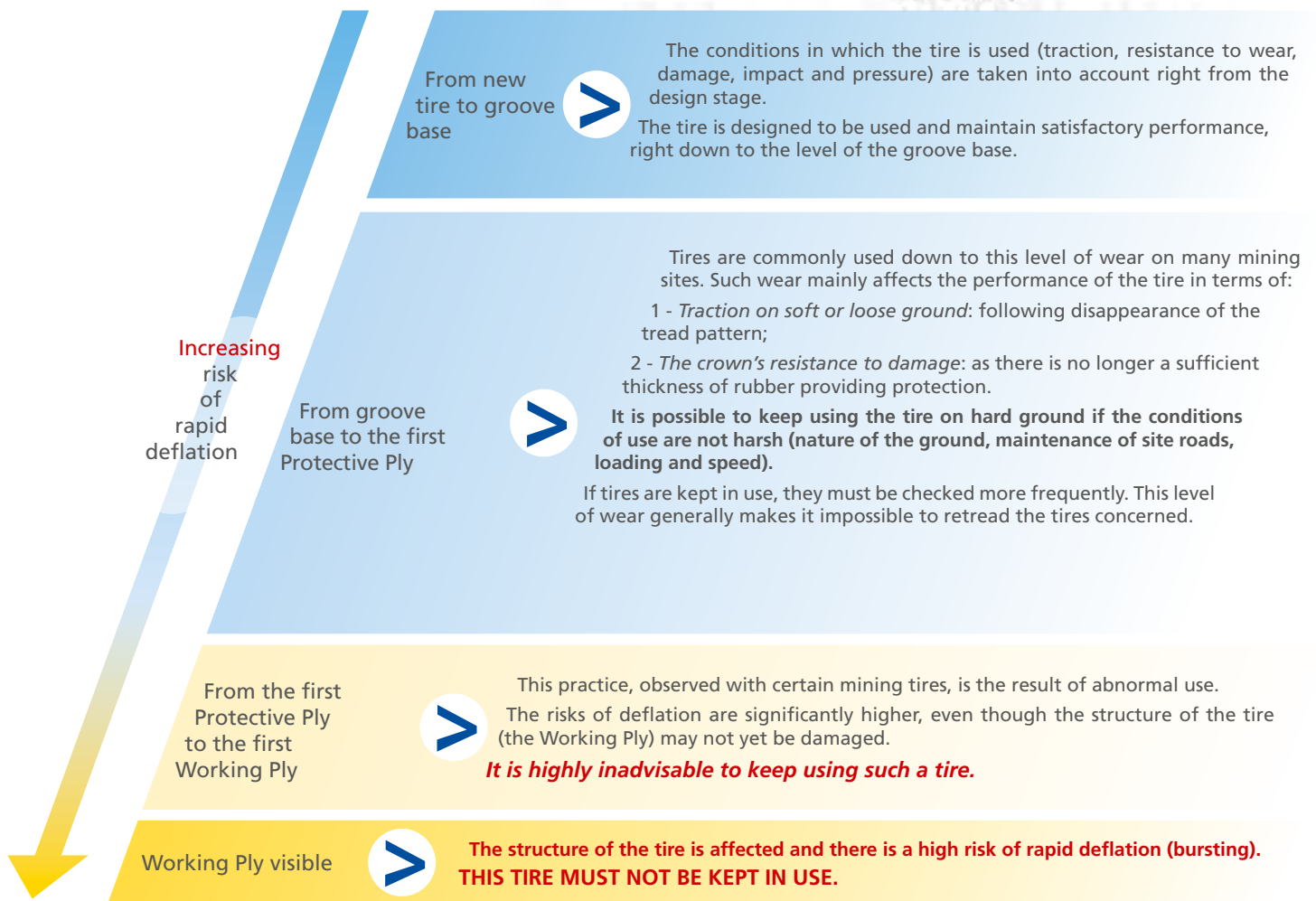
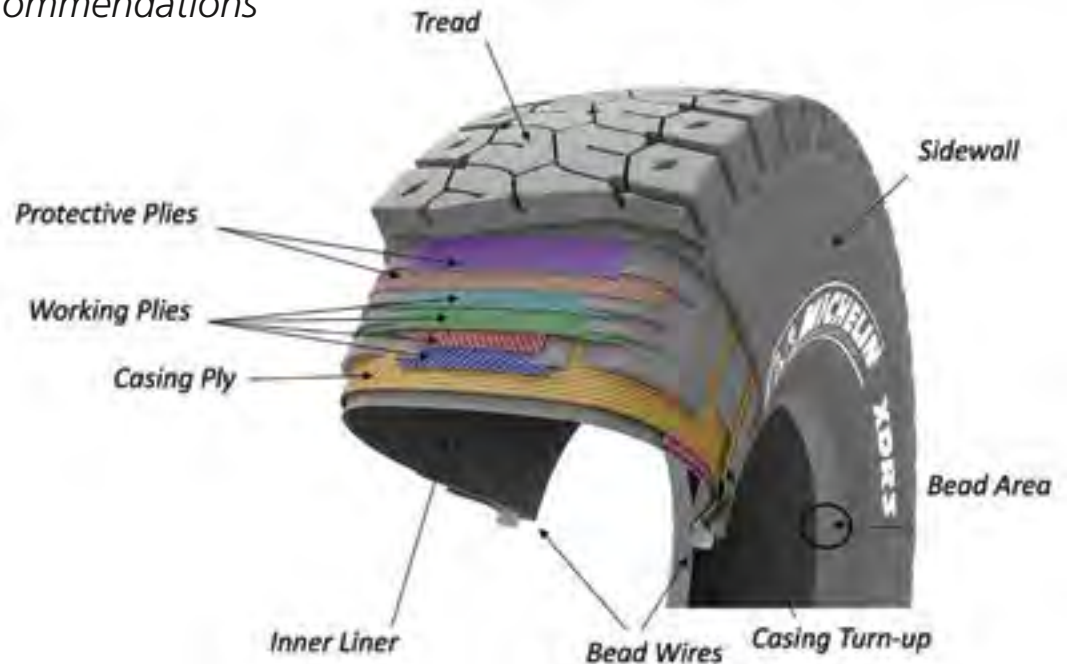

Michelin very strongly recommends that decisions to remove used tires from service are always taken in strict compliance with SAE standard J2611 "Off-Road Tire Conditions Removal Guidelines."

It is also underlined that the owner of a tire is solely responsible for the decision to keep it in use or remove it from service (unless specifically agreed otherwise in the context of the above standard).

MACHINES AND THEIR USES

135 MACHINE CONFIGURATIONS

136 MACHINES FOR OPEN-PIT MINES
AND QUARRIES

139 MACHINES FOR EARTHWORKS
AND INFRASTRUCTURE SITES

144 MACHINES SPECIFICALLY
FOR ROAD CONSTRUCTION

146 MOBILE CRANES

148 MACHINES FOR UNDERGROUND MINES

150 HANDLING MACHINES

157 SPECIAL MACHINES

MACHINES AND THEIR USES

This supplement provides a summary of the main machines used in earthmoving applications.

It is not intended to replace the documentation and technical recommendations of the manufacturers, which remain the sole reference documents.

In order to select the most suitable tires, refer to the following brochures:

*“Michelin Solutions for Earthmover and Public Works,”
“RoRo Forklift Michelin Solutions for Industrial and Port Handling,” and ask a Michelin technician for advice.*

MACHINE CONFIGURATIONS p.139

MACHINES FOR OPEN-PIT MINES AND QUARRIES p.140

Rigid Dump Trucks
Bottom Dump Trucks
Coal haulers
Large Loaders
Dozers, Rubber-wheel dozers
Large Motor Graders

MACHINES FOR EARTHWORKS AND INFRASTRUCTURE SITES p.143

Small Dump Trucks
Rigid Dump Trucks
Articulated Dump Trucks
Medium Loaders
Small Loaders
Scrapers
Motor Graders
Compact Machines
Wheeled Excavators
Backhoe Loaders
Skid Steers
Site Dumpers
Telescopic Handlers

MACHINES SPECIFICALLY FOR ROAD CONSTRUCTION p.148

Soil Stabilizers and Road Reclaimers
Planers, Asphalt Milling Machines
Mobile Feeders for Asphalt Pavers
Asphalt Pavers
Compactors, Rollers

MOBILE CRANES p.150

Truck Cranes (TC)
All Terrain (AT) Cranes
City Cranes
Rough Terrain (RT) Cranes
Compact Industrial Cranes
Mobile Harbor Cranes

MACHINES FOR UNDERGROUND MINES p.152

Support Machines
Wheeled Loaders
Dump Trucks
Coal Haulers
Shuttle Cars

HANDLING MACHINES p.154

Front-Loading Forklift Trucks
Small and Medium Forklifts, Small and Medium Forklift Trucks
Large Forklifts, Large Forklift Trucks
RoRo Forklift, Forklift RoRo Trucks
Container Handlers, Masted Lift Trucks

Reach Stackers

Reach Loggers
Fork Loggers
Reach Loggers

Side Loaders

Straddle Carriers and Transtainers

Straddle Carriers
Transtainers, Rubber-Tired Gantry (RTG) Cranes
Boat Lifter

Special Tractors

Terminal Tractors and RoRo Trucks
Towbar and Towbarless Tractors

SPECIAL MACHINES p.161

Railroad Loco-Tractors
Slag Pot Carriers
Girder Carriers, Span Carriers
Road Trains
Special Intervention Vehicles

Machine configurations

SYMBOL*	RIM + TIRE AXLE POSITIONS	DRIVING AXLE POSITIONS	STEERING AXLE POSITIONS	DIAGRAMMATIC REPRESENTATION
4 x 2	4	2	(2)	
4 x 4	4	4	(2)	
4 x 4 x 4	4	4	4	
6 x 2	6	2	(2)	
6 x 2	6	2	(2)	
6 x 4	6	4	(2)	
6 x 6	6	6	(2)	
6 x 2 x 4	6	2	4	
8 x 4	8	4	(2)	
8 x 4 x 4	8	4	4	
8 x 6 x 4	8	6	4	
8 x 8	8	8	(2)	

How to read this table?

- the first figure corresponds to the number of axle positions
- the second figure corresponds to the number of driven axle positions
- the third figure corresponds to the number of steer positions (this third number is optional and is normally only used when more than one axle—2 steer positions—is used)

Machines for open-pit mines and quarries

Main features of these types of application:

- Traveling on more or less well-maintained site roads;
- For dump trucks and loaders, intermittent transport cycles: the loaded operating time varies from 30% to 70% of the total time.

Rigid Dump Trucks

MAIN USES

In open-pit mines, stone and sand quarries, transporting very heavy loads from the face to the crushing or processing stations.



Important:

The capacity of the loaders (or excavators) must be appropriate for that of the means of transport used. This is a key factor for operational productivity.

It depends on the number of loading passes required to reach the maximum payload of the rigid dump trucks (3 to 5 in mines, more in quarries).

PROFILE

Rigid dump trucks.

AXLES

- Front steering axle, generally with single tire fitments. It is very occasionally a drive axle and/or has dual-tire fitments.
- Rear drive axle, generally with dual-tire fitments.

A few rigid dump trucks have three axles. The two rear drive axles are then mounted with single-tire fitments.

PAYLOAD

33 to 400 U.S. tons (30 to 360 tons).

MAXIMUM SPEED

- Empty: 50 mph (80 km/h).
- Loaded: 40 mph (65 km/h).

Bottom Dump Trucks

MAIN USES

- The method of unloading via the bottom and their high capacity restrict them to use on large sites with only minor gradients, on which the materials are brittle (transporting coal, etc.).
- Suitable for applications involving long cycles.



PROFILE

Machine comprising:

- A tractor (rigid dump truck without its dump body);
- A long trailer which can open at the bottom

It is thus a combination of a rigid and an articulated dump truck.

AXLES

- Two axles for the tractor: the front steering axle always has single-tire fitments. The rear drive axle always has dual-tire fitments.
- One axle for the dump body, generally with single-tire fitments, and very occasionally with dual-tire fitments.

PAYLOAD

Up to 150 U.S. tons (136 tons) (depending on the model).

MAXIMUM SPEED

40 mph (65 km/h).

Coal Haulers

MAIN USE

- Specialty machines for transporting brittle materials.
- Specifically intended for sites with only minor gradients and long transport cycles.



PROFILE

- Compact machines built around a bottom dump body.
- Large-capacity hopper with unloading via the bottom.

AXLES

- Two suspended axles, with dual-tire fitments at both front and rear
- Rear drive axle and front steering axle, with large steering angles (around 90°).

PAYLOAD

245 U.S. tons (220 tons).

MAXIMUM SPEED

47 mph (75km/h).

Large Loaders

MAIN USE

- Mainly loading transport vehicles at mine or quarry faces.
- More rarely, loading and direct transport to the crusher (load and carry). The range of these loaders can then reach several hundred meters.



PROFILE

- Buckets that can contain up to 35 m³ (45 yd³).
- Transmission with wheel spin limiter and torque converter.
- Articulation providing a steering angle of around 40° (in each direction).

AXLES

- Front steering and drive axle.
- Rear drive axle.

PAYLOAD

11 to 77 u.s. tons (10 to 70 tons)(depending on the model).

MAXIMUM SPEED

25 mph (40 km/h).

Dozers, Rubber-Wheel Dozer

MAIN USE

- Maintenance of site roads, loading/unloading areas and open-air storage areas.
- Moving materials using an adjustable front blade.



PROFILE

Structure and engine similar to those of loaders, from which they are generally derived.

AXLES

Two drive axles.

MAXIMUM SPEED

25 mph (40 km/h).

Large Motor Graders

MAIN USE

- Graders are used in open-pit mines and quarries where they maintain the site roads, helping to :
 - considerably reduce the traveling times of transport machines;
 - reduce accidental tire damage (for example, punctures as a result of repeatedly traveling over blocks fallen from moving vehicles);
 - extend the lifetime of earthmover tires mounted on other vehicles.
- They are also used for banking and grading underlayers.



PROFILE

Machines equipped with a central blade and sometimes a front blade, and/or a ripper at the rear.

AXLES

- One front steering axle, which is sometimes also a drive axle (very occasionally two axles).
- Two rear tandem drive axles.

MAXIMUM SPEED

- Working: 22 mph (35 km/h).
- Traveling: 31 mph (50 km/h).



Large motor grader

Machines for earthworks and infrastructure sites

Main features of these types of application:

- Machines used on various types of site (construction, public works, etc.);
- Covering limited distances at relatively low speeds.
- Use sometimes comparable to that in mines and quarries, but much less intensive.

Small Dump Trucks

MAIN USE

Over potentially long distances,

- transporting materials for earthworks and infrastructure sites (highways, rail track construction, dams, etc.);
- transporting materials in stone and sand quarries from the face to the crushing or processing stations.



PROFILE

Intermediate machines, midway between road trucks and earthmover rigid dump trucks.

AXLES

- The front axle or axles, which have single-tire fitments, are mainly steering axles, and may sometimes also be drive axles.
- Two rear drive axles, with either single- or dual-tire fitments.

PAYLOAD

17 to 77 U.S. tons (15 to 70 tons).

MAXIMUM SPEED

44 mph (70km/h).

Rigid Dump Trucks

MAIN USE

On earthworks or infrastructure sites (highways, rail track construction, dams, etc.), transporting materials, sometimes over long distances (cycles of up to 40 kilometers • 65 miles).



PROFILE

Rigid dump trucks.

AXLES

- The front steering axle generally has single-tire fitments. It is very occasionally a drive axle and/or has dual-tire fitments.
- The rear drive axle generally has dual-tire fitments.

A few rigid dump trucks have three axles. The two rear drive axles are then mounted with single-tire fitments.

PAYLOAD

33 to 110 U.S. tons (30 to 100 tons).

MAXIMUM SPEED

- Empty: 50 mph (80km/h).
- Loaded: 40 mph (65 km/h).

Important:

The capacity of the loaders (or excavators) must be appropriate for that of the means of transport used. This is a key factor for operational productivity.

It depends on the number of loading passes required to reach the maximum payload of the rigid dump trucks.

Articulated Dump Trucks

MAIN USE

- Transporting materials on earthworks and infrastructure sites.
- Articulated dump trucks are sometimes found on the same sites as rigid dump trucks, apart from quarries, where they are rarely used.



PROFILE

- Machines comprising a tractor and a permanently attached articulated trailer with a tilting dump body or a dump body equipped with an ejector.
- Articulation providing a steering angle of around 45° (in each direction).
- Suitable for traveling on any surface, with outstanding ability to travel over loose or uneven terrain.

AXLES

- Tractor with one axle with single-tire fitments.
- Trailer with two axles with single-tire fitments, or sometimes a single axle.
- These are all generally drive axles.

PAYLOAD

11 to 50 U.S. tons (10 to 45 tons).

MAXIMUM SPEED

- Empty: 40 mph (65 km/h).
- Loaded: 34 mph (55 km/h).

Medium Loaders

MAIN USE

- Picking up materials at a deposit point and unloading at a nearby point (truck dump body, crusher, etc.).
- Loading and direct transport to the crusher (load and carry). The range of these loaders can then reach several hundred meters.



PROFILE

- Machines built around an articulated chassis fitted with a bucket at the front.
- Transmission with wheel spin limiter and torque converter.

AXLES

Two drive axles.

PAYLOAD

2 to 10 U.S. tons (2 to 9 tons) (depending on the model).

MAXIMUM SPEED

25 mph (40 km/h).

Small Loaders

MAIN USE

Picking up stock and carrying out support work in a wide variety of sites (road surfacing or concrete plants, incineration plants, public works, etc.).



PROFILE

- Compact machine providing excellent maneuverability.
- The bucket can be replaced by other tools (fork, etc.) as required.
- Articulation providing a steering angle of around 40° (in each direction).

AXLES

- Front steering axle which is also generally a drive axle.
- Rear drive axle.

PAYLOAD

Up to 1 U.S. ton (1 tons) (depending on the model).

MAXIMUM SPEED

19 mph (30 km/h).

Scrapers

MAIN USE

Self-loading, transport and self-unloading, mainly on infrastructure sites and open-pit coal mines.

These machines comprise of a tractor and a bowl equipped with a blade to scrape the ground, pick up materials and place them in the bowl.

There are also motor scrapers on which the bowl is equipped with elevator mechanism or auger loading system.



PROFILE

- Single-engine machine (front drive axle): the engine only drives the machine during transport. During loading, one or more bulldozers push the scraper to move it along.
- Twin-engine machine (each axle is a drive axle): tandem (push-pull) loading to combine the power of both machines (4 engines) on a single blade. One machine pulls and the other pushes. They are loaded alternately.
- Articulation providing a steering angle of around 90° (in each direction).

AXLES

- One axle with single-tire fitments for the tractor.
- One axle with single-tire fitments for the bowl.

MAXIMUM SPEED

- Working: 25 mph (40 km/h).
- Traveling: 34 mph (55 km/h).

Motor Graders

MAIN USE

- Motor graders are used in earthworks, construction and public works for banking, and leveling subgrades and finish grades (laser work on gravel, cement, asphalt, etc.).
- They are also extremely effective at clearing snow from roads.



PROFILE

Machines equipped with a central blade and sometimes a front blade, and/or a scarifier at the rear.

AXLES

- One front steering axle, which is sometimes also a drive axle (very occasionally two axles).
- Two rear tandem drive axles.

MAXIMUM SPEED

- Working: 22 mph (35 km/h).
- Traveling: 31 mph (50 km/h).



Compact Machines

Wheeled Excavators

MAIN USE

- Digging trenches.
- Loading loose materials (soil, sand, etc.).



PROFILE

- Chassis with a cab used for both driving the machine and operating the arm.
- Articulated arm equipped with a backhoe.
- Larger models are mounted on tracks.

AXLES

- Front steering axle, with single- or dual-tire fitments;
 - Rear drive axle, with single- or dual-tire fitments;
- With dual tire fitments, the centering ring between the tires makes it preferable to use tires with reinforced sidewalls. The use of stabilizers is necessary to support the machine during work.

PAYLOAD

Up to 3 U.S. tons (3 tons) (depending on the model).

MAXIMUM SPEED

12 mph (20 km/h).

Backhoe Loaders

MAIN USE

- Digging trenches with the backhoe.
- Loading material with the bucket.

Their versatility makes them useful in all types of construction, public works and earthworks.



PROFILE

- Bucket at the front.
- Backhoe at the rear.

AXLES

- Front steering axle, sometimes also a drive axle.
- Rear drive axle.

The tires mounted at the front are often smaller than those at the rear.

PAYLOAD

Up to 2 U.S. tons (2 tons) (depending on the model).

MAXIMUM SPEED

25 mph (40 km/h).

Skid Steers

MAIN USE

Small loading operations on small sites (parks, gardens, etc.) and/or those requiring very precise work.



PROFILE

- Rigid chassis with a cab used for both driving the machine and operating the arms.
- Two articulated arms that can be equipped with many different types of tool (fork, bucket, etc.).

NUMBER OF WHEELS

No axles, wheels are connected with hydraulic motors (one for each side) thanks to chains.

The driver changes direction by braking the wheels on the side toward which he is steering (in the same way as with tracked vehicles).

PAYLOAD

1 to 2 U.S. tons (1 to 2 tons).

MAXIMUM SPEED

19 mph (30 km/h).

Site Dumpers

MAIN USE

Very easy to handle, used on a wide variety of sites (infrastructures, parks, etc.) for transport and clearing work.



PROFILE

Machines with tilting skip.

AXLES

- Front is generally the drive axle.
- Rear steering axle.

PAYLOAD

2 to 10 U.S. tons (2 to 9 tons).

MAXIMUM SPEED

19 mph (30 km/h).

Telescopic Handlers

MAIN USE

Moving, storage and loading at considerable heights (pallets, stackable materials).



PROFILE

- Chassis with a cab used for both driving the machine and operating the arm.
- Telescopic arm that can be equipped with many different tools (fork, bucket, etc.).

NUMBER OF WHEELS

- Four drive and steering wheels which can be turned in various ways to provide specific movement options.
- Outriggers used when carrying out operations at great height.

MAXIMUM SPEED

16 mph (25 km/h).

MAXIMUM LIFTING CAPACITY

- Up to 23 U.S. tons (21 tons) (depending on the model).
- Up to 19 yd (17 meters) (depending on the model).

METHOD OF MOVEMENT

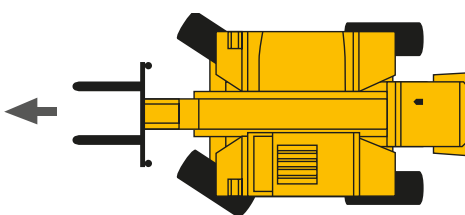

Normal

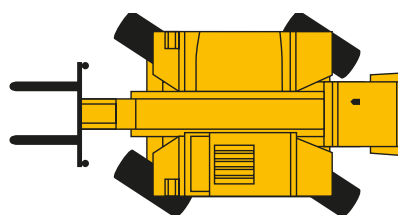

Sideways

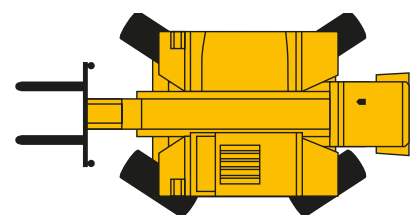

In opposition

Machines specifically for road construction

Main features of these types of application:

- designed exclusively for use in the construction and maintenance of highway systems;
- carry out specific functions: preparation of the ground, finishing, etc.

Soil Stabilizers and Road Reclaimers

MAIN USE

These earthworks machines are used to prepare the ground.



PROFILE

- Hopper for transporting materials.
- Tool for incorporating stabilizers contained in the hopper (lime, etc.) in the soil.
- High traction and flotation capability.

AXLES

- Front drive axle which is sometimes also a steering axle.
- Rear steering axle which is often a drive axle.

All four wheels can be identical or smaller wheels may be mounted at the rear.

MAXIMUM SPEED

9 mph (15 km/h).

Planers, Asphalt Milling Machines

MAIN USE

Removing asphalt and concrete from road surfaces to enable a new top course to be laid.



PROFILE

These machines:

- comprise a milling unit (adjusted via a manual or electric mechanism), a heating system to soften the asphalt and a conveyor belt for carrying the asphalt to a dump truck;
- mounted on tracks or tires that are subjected to very high temperatures.

On some models, there is also a sprinkler system which is used to limit the formation of dust and protect the equipment against premature wear.

MAXIMUM SPEED

- Working: 1.25 mph (2 km/h).
- Traveling: 5 mph (8 km/h).

Mobile Feeders for Asphalt Pavers

MAIN USE

For feeding asphalt pavers (the asphalt arrives on a conveyor belt).



PROFILE

Machines mounted on tires or tracks.

MAXIMUM SPEED

- Working: 1 mph (2 km/h).
- Traveling: 9 mph (15 km/h).

Asphalt Pavers

MAIN USE

Laying the top course on a road prepared previously during the earthworks.



PROFILE

Self-propelled machine comprising:

- a hopper, capacity 4 yd³ to 33 yd³, to take the asphalt. It is supported by tired wheels (two or four), which are steering and sometimes drive wheels;
- a chassis carrying the diesel-powered engine, the product transfer mechanism and the control position, supported by one drive axle with single-tire fitments.
- a vibrating or fixed screed for applying the product in an even layer.

In some cases, this machine is mounted on tracks.

MAXIMUM SPEED

- Working: 33 yd/mn (30 m/mn).
- Traveling: 3 mph (5 km/h).

Compactors, Rollers

MAIN USE

- Compacting the ground.
- Preparation of surfaces during road construction, leveling the ground for finishing work.



AXLES

Depending on the type of machine:

- two axles with smooth rollers or with tamping feet;
- one front axle with a smooth roller or with tamping feet, one rear axle with two tires;
- two axles on tires (two to five smooth tires for each one).

MAXIMUM SPEED

- Working: 3 mph (5 km/h).
- Traveling: 16 mph (25 km/h) (depending on the model).

Mobile cranes

Main features of these types of application:

- Mainly designed for moving over well-maintained surfaces.
- The tires of mobile cranes are always loaded. They must also provide good road handling when traveling.

Truck Cranes (TC)

MAIN USE

- Almost exclusively on-road use.
- Excellent stability on solid surfaces.



PROFILE

- Compact and therefore easy to handle.
- Mounted on a reinforced truck chassis and fitted with truck tires.

MAXIMUM LIFTING CAPACITY

- Up to 99 U.S. tons (*90 tons*) (depending on the model).
- Up to 77 yards (*70 meters*) (depending on the model).

MAXIMUM SPEED

56 mph (*90 km/h*).

All-Terrain (AT) Cranes

MAIN USE

Very maneuverable and very adaptable.
Mainly on-road use, occasionally on-site.



PROFILE

- Two cabs: driver's cab and crane operator's cab.
- The earthmover tires, mounted with single-tire fitments, can take up to 12 tons (*12 tons*) per axle.

AXLES

- Drive and steering.
- Two to ten axles.

MAXIMUM SPEED

50 mph (*80 km/h*).

MAXIMUM LIFTING CAPACITY

- Up to 1,300 U.S. tons (*1.200 tons*) (depending on the model).
- Up to 208 yards (*190 meters*) (depending on the model).
- Lifting operations carried out with outriggers deployed.

City Cranes

MAIN USE

Designed to work in an urban environment, and more generally anywhere where the crane has to be compact (reduced site accessibility, limited area for movement):

- single cab;
- permitted to travel on the road (truck or earthmover tires).



AXLES

Up to four axles.

MAXIMUM SPEED

56 mph (*90 km/h*).

MAXIMUM LIFTING CAPACITY

- Up to 88 U.S. tons (*80 tons*) (depending on the model).
- Up to 66 yards (*60 meters*) (depending on the model).

Rough Terrain (RT) Cranes

MAIN USE

Machines designed exclusively to travel short distances off-road.



PROFILE

- Very maneuverable.
- Single cab used for both driving the machine and operating the crane.
- Excellent ability to travel over rough terrain.

AXLES

Two, sometimes three, drive and steering axles.

MAXIMUM LIFTING CAPACITY

- Up to 149 U.S. tons (135 tons) (depending on the model).
- Up to 104 yards (95 meters) (depending on the model).

MAXIMUM SPEED

25 mph (40 km/h).

Compact Industrial Cranes

MAIN USE

- Lifting on industrial sites: warehouses, workshops, etc.
- Traveling short distances, rarely on roads.



PROFILE

- Small machines with a single cab and no suspension.
- Four independent wheels fitted with handling equipment tires.

MAXIMUM LIFTING CAPACITY

- Up to 27 U.S. tons (25 tons) (depending on the model).
- Up to 33 yards (30 meters) (depending on the model).

MAXIMUM SPEED

19 mph (30 km/h).

Mobile Harbor Cranes

MAIN USE

- Exclusively for port and harbor areas.
- These cranes, which are very heavy, very large and difficult to maneuver, travel very little and with difficulty.



AXLES

- Several drive, generally also steering, axles.
- The largest of these cranes have seven fixed axles and five steering axles and are fitted with 96 earthmover tires.

MAXIMUM LIFTING CAPACITY

- Up to 220 U.S. tons (200 tons) (depending on the model).
- Up to 61 yards (56 meters) (depending on the model).
- Lifting operations carried out with outriggers deployed.

MAXIMUM SPEED

6 mph (10 km/h).

Machines for underground mines

Main features of these types of application:

- These low, compact machines are used in underground roadways and tunnels;
- Designed to work in confined operating spaces;
- Loading and transporting materials over relatively short distances.

Support Machine

MAIN USE

Each type of machine is designed for a specific purpose: drilling, scaling, etc.



Scaling

PROFILES

Generally articulated machines.

AXLES

Two axles with single-tire fitments.

MAXIMUM SPEED

Varies according to the type of machine.

Wheeled Loaders

MAIN USE

- Loading and transport in mines.
- For hazardous uses, these machines can be controlled remotely or wire-guided, enabling the "driver" to be at a safe distance.



PROFILE

• Articulated machines, with a combustion engine or an electric motor.

• Fitted with one or two articulated arms with bucket.

AXLES

Two drive axles with single-tire fitments.

PAYLOAD

Up to 17 U.S. tons (15 tons) (depending on the model).

MAXIMUM SPEED

• Working: 12 mph (20 km/h).

• Traveling: 19 mph (30 km/h).

Dump Trucks

MAIN USE

Transporting all types of ore.



PROFILE

Tilting dump body or fixed dump body fitted with an ejector.
Articulated machine.

AXLES

• Two drive axles with single-tire fitments.

PAYLOAD

Up to 66 U.S. tons (60 tons) (depending on the model).

MAXIMUM SPEED

• Empty: 25 mph (40 km/h).

• Loaded: 16 mph (25 km/h).

Coal Haulers

MAIN USE

Transporting coal on underground roadways.



PROFILE

Central articulation providing a steering angle of around 45° (in each direction).

AXLES

- Two drive axles with single-tire fitments.
- Electric power, independent for each position (for certain models).

PAYLOAD

Up to 22 U.S. tons (20 tons).

MAXIMUM SPEED

Approximately 6 mph (10 km/h) (varies according to the model).

Shuttle Cars

MAIN USE

Transporting coal on underground roadways.



PROFILE

- Machine with rigid chassis equipped with a conveyor belt for automatic unloading.
- Cabled power supply.

AXLES

Two drive and steering axles with single-tire fitments.

PAYLOAD

Up to 17 U.S. tons (15 tons).

MAXIMUM SPEED

Between 3 and 6 mph (5 to 10 km/h).



Underground wheeled loader

Handling machines

Main features of these types of application:

- Industrial sectors, intermodal centers, port activities, etc.;
- Traveling on well-maintained surfaces: concrete, asphalt, paving, etc.

Front-Loading Forklift Trucks

- Loading/unloading vehicles, storage of materials or palletized items.
- Handling all types of materials: lifting, and transport over short distances.

Small and Medium Forklifts, Small and Medium Forklift Trucks

MAIN USE

All industrial storage and handling.

PROFILE

- Equipped with forks (and/or grabs) which move vertically and horizontally on a telescopic mast.
- Electric, gas or diesel powered.

MAXIMUM SPEED

- Empty: up to 25 mph (40 km/h).
- Loaded: up to 16 mph (25 km/h).



AXLES

Front axle always the drive axle, rear axle always the steering axle:

-when empty, the main part of the weight (engine, batteries and counterweight for balancing the loaded truck) is over the rear axle.

-when loaded, the main part of the weight is over the front axle.

TIRES USED

Small trucks:

- two wheels (with single-tire fitments) at the front and 1 or 2 wheels with dual-tire fitments at the rear;
- flexible solid or solid tires.

Medium capacity trucks:

- two wheels (with single-tire fitments) at the front and the rear;
- flexible solid, conventional or Radial tires.

Larger capacity trucks:

- two dual-tire fitments at the front and two wheels (with single-tire fitments) at the rear;
- flexible solid, conventional or Radial tires.

MAXIMUM LIFTING CAPACITY

- Up to 18 U.S. tons (16 tons) (depending on the model).
- Up to 10 yards (9 meters) (depending on the model).

Large Forklifts, Large Forklift Trucks

MAIN USE

- Storage and handling of heavy loads.
- Identical design to the previous trucks, but with a greater lifting capacity.



PROFILE

Diesel-powered only.

AXLES

- 1 front drive axle, generally with dual-tire fitments.
- 1 rear steering axle.

CAPACITÉ DE LEVAGE

- Up to 55 U.S. tons (50 tons) (depending on the model).
- Up to 9 yards (8 meters) (depending on the model).

MAXIMUM SPEED

- Empty: 19 mph (30 km/h).
- Loaded: 12 mph (20 km/h).

RoRo Forklift, Forklift RoRo Trucks

MAIN USE

Loading and unloading ships (RoRo means Roll-on/Roll-off).

- Low trucks for accessing ships' holds.
- Handling containers and palletized materials.



PROFILE

Equipped with forks (and/or grabs) which move vertically and horizontally on a special telescopic mast.

AXLES

- 1 front drive axle, generally with dual-tire fitments.
- 1 rear steering axle.

MAXIMUM LIFTING CAPACITY

Up to 66 U.S. tons (60 tons) (depending on the model).

MAXIMUM SPEED

- Empty: 19 mph (30 km/h).
- Loaded: 12 mph (20 km/h).

Container Handlers, Masted Lift Trucks

MAIN USE

- Handling and moving containers.
- Two types of machine:
 - empty container handlers for moving and storing (at heights of up to 27 yards – 25 meters) empty containers;
 - laden container handlers for lifting and moving containers weighing up to 55 U.S. tons (50 tons).



PROFILE

- Very powerful lift trucks, equipped with a telescopic mast on which a spreader (large gripper or clamp) moves. The spreader adjusts to the size of the containers, takes hold of them, lifts them and moves them.
- When empty, the main part of the weight (engine, batteries and counterweight) is over the rear axle. When loaded, the main part of the weight is over the front axle.

AXLES

- Front drive axle with dual-tire fitments.
- Rear steering axle with single-tire fitments.

MAXIMUM LIFTING CAPACITY

- Up to 55 U.S. tons (50 tons) (depending on the model).
- Up to 30 yards (27 meters) (9 empty containers) and up to 16 yards (15 meters) (5 full containers).

MAXIMUM SPEED

- Empty: 25 mph (40 km/h).
- Loaded: 16 mph (25 km/h).

Reach Stackers

MAIN USE

Handling and moving containers.

AXLES

- Front drive axle with dual tire fitments.
- Rear steering axle with single-tire fitments.



PROFILE

- Midway between a crane and a forklift truck: their telescopic arm gives them two major advantages over large forklift trucks and container handlers:
 - ability to reach containers on a 2nd or 3rd row;
 - ability to move around in more restricted spaces.
- A chassis, a driving position and a telescopic arm equipped with an articulated spreader for handling appropriate for the size of the containers.
- When empty, the main part of the weight is over the rear axle. When loaded, the main part of the weight is over the front axle.
- Outriggers enabling stacking at considerable heights and distances: 2nd row, 13 yard (12 meters) and on the 3rd row, 9 yards (9 meters).

MAXIMUM LIFTING CAPACITY

- Up to 45 U.S. tons (45 tons) (depending on the model).
- Up to 26 yards (24 meters) (8 empty containers) and up to 20 yards (18 meters) (6 full containers).

MAXIMUM SPEED

- Empty: 25 mph (40 km/h).
- Loaded: 12 mph (20 km/h).

Machines sometimes equipped with a device which limits the speed when loaded.



Container handler

Reach Loggers

Fork Loggers

MAIN USE

- Handling logs.
- These machines can pick up an entire truckload of wood in a single operation.



PROFILE

A log grapple replaces the spreader on large front-loading forklift trucks.

AXLES

- Front drive axle with single- or dual-tire fitments.
- Rear steering axle with single-tire fitments.

MAXIMUM LIFTING CAPACITY

- Up to 9 U.S. tons (8 tons) (depending on the model).

MAXIMUM SPEED

- Empty: 19 mph (30 km/h).
- Loaded: 6 mph (10 km/h).

Reach Loggers

MAIN USE

Reach-stackers adapted for logging. They are used to:

- handle and move logs on the 2nd or 3rd row and/or in restricted spaces;
- pick up logs from below ground level (for example, from a river, while standing on the wharf).



PROFILE

A log grapple replaces the spreader on large front-loading forklift trucks.

AXLES

- Front drive axle with dual-tire fitments.
- Rear steering axle with single-tire fitments.

MAXIMUM SPEED

- Empty: 25 mph (40 km/h).
- Loaded: 12 mph (20 km/h).

Side Loaders

MAIN USE

Machines for transport rather than lifting, designed to work in restricted spaces (warehouses with racking, etc.):

- Transporting long items (pipes, iron bars, ducts, tree trunks);
- Electric, gas or diesel powered.



PROFILE

- Chassis with a driving position and design comparable to those of a front-loading forklift truck but at the side.
- During loading operations these machines are often on rigid outriggers.

AXLES

- Front axle always the steering axle.
- Rear axle always the drive axle.

MAXIMUM LIFTING CAPACITY

Up to 17 U.S. tons (15 tons) (depending on the model).

MAXIMUM SPEED

- Empty: 25 mph (40 km/h).
- Loaded: 9 mph (15 km/h).

Straddle Carriers and Transtainers

Straddle Carriers

MAIN USE

- Moving and handling containers (ports and intermodal centers): loading, transport and stacking.
- Straddling a row of containers stacked at several heights, picking up the selected container and transporting it between their "legs" to another row, a truck or a train.

A new generation of machines is now coming onto the market that is lower and therefore faster (Shuttle, Sprinter, etc.), which is particularly suitable for transport and for loading vehicles.



PROFILE

Platform with a driving position (at the front or side) at the top of the metal structure (legs).

- Fixing assembly (gripper, hoist or spreader) integral with this platform for picking up and moving containers.
- Depending on the model, ability to stack 20 or 40-foot containers 3 or 4 high, to move one 20-foot or 40-foot container (single spreader) or two 20-foot containers (twin spreader).

LIFTING CAPACITY

- Up to 44 U.S. tons (40 tons) for single spreaders.
- Up to 66 U.S. tons (60 tons) for some twin spreader models.

NUMBER OF AXLES

- No axles, only independent wheels.
- Standard: 8 steering wheels with single-tire fitments, 4 of which are generally drive wheels.
- Sprinter or Shuttle type: 6 drive wheels, of which the 4 end wheels are steering wheels.

MAXIMUM SPEED

19 mph (30 km/h) when loaded.

Transtainers, Rubber-Tired Gantry (RTG) Cranes

MAIN USE

- Handling containers in ports.
- Straddling several rows (1 to 8) of containers stacked at varying heights (2 to 7 tiers) and a road for trucks and terminal tractors.

Mainly used for sorting containers, and their storage and removal from storage, these machines move sideways. Although lengthwise movement is possible, it is rare.



PROFILE

- Much heavier than straddle carriers.
- Move in a straight line along the row of containers, which may be several hundred meters long.
- Turning and changing direction is always carried out with the machine stationary, in areas specifically designed for this purpose (plates made of smooth metal or coated with slippery paint).

AXLES

All steering (90°).

- Fitted with 1 or 2 tires (in line or on bogies), or even 4 tires (2 bogies in line) for each of the 4 feet.
- There are also identical systems which travel on rails (Rail Mounted Gantry or RMG).

MAXIMUM SPEED

1 to 5 mph (2 to 8 km/h).

Special tractors

Terminal Tractors and RoRo Trucks

MAIN USE

- Moving trailers in ports and intermodal centers.
- Loading into/unloading from the inside of boats (ferries): road trailers, low-bed trailers loaded with 1 to 2 container(s).



PROFILE

Vehicles similar to road tractors but smaller. They are not designed to travel on the road, but on very adherent and therefore abrasive surfaces.

- Very easy to handle for moving easily between ships' decks and rows of containers.
- Very powerful to provide the tractive effort required for constantly working on braking torque/driving torque.
- Their fifth wheel has the particular feature of being able to lift in order to adapt to all types of trailer.
- The driving position (180° rotation) enables the tractor to travel at the same speed backward or forward.

AXLES

- The front steering axle has single-tire fitments.
- The rear drive axle has dual-tire fitments.
- Machines with 3 axles are used in some ports to pull several trailers coupled together.

PAYLOAD

Up to 39 U.S. tons (35 tons) (depending on the model).

MAXIMUM SPEED

31 mph (50 km/h).

Towbar and Towbarless Tractors

MAIN USE

Moving aircraft on the ground.

AXLES

2 axles and 4 drive wheels (possibility of locking one axle).



PROFILE

Appropriate size for the aircraft they move.

- Very powerful, to provide the necessary tractive effort: constantly work on adherent and therefore abrasive surfaces.
- Conventional towbar tractors move the aircraft using a towbar. They have a high, constant load.
- Towbarless tractors, equipped with a cradle which slides under the front wheel, carry the aircraft's nose gear. Their load is cyclical.

LIFTING CAPACITY

Up to 77 U.S. tons (70 tons) (depending on the model).

MAXIMUM SPEED

- 19 mph (30 km/h) for pulling an empty aircraft (parking, positioning at the terminal, etc.).
- 3 mph (5 km/h) when the fully loaded aircraft pushes back from the departure terminal.

Special machines

Main features of these types of application:

- Traveling on fairly well-maintained site roads requiring very regular maintenance.
- Intermittent transport cycles: the loaded operating time represents 40% to 60% of the total time.
- Their commercial name may vary according to the manufacturer.

Railroad Loco-Tracteur

MAIN USE

- Pulling trains in freight areas, operate alternately on roads and on rails.



PROFILE

The metal wheels are lowered when the vehicle is running on rails (these wheels are only used as guides).

- The tires, generally handling equipment tires, must be inflated to a high pressure. During use, they develop characteristic wear in the center.
- Short periods of use, only limited distances covered.

MAXIMUM SPEED

19 mph (30 km/h).

Slag Pot Carriers

MAIN USE

In metallurgical plants, transporting vessels containing molten materials.



AXLES

- 1 drive and steering front axle, equipped with earthmover tires;
- 1 rear axle, equipped with earthmover tires or handling equipment tires (therefore, often flexible solid tires).

MAXIMUM SPEED

- Empty: up to 22 mph (35 km/h) (depending on the model).
- Loaded: up to 9 mph (15 km/h) (depending on the model).

Girder Carriers, Span Carriers

MAIN USE

Transporting abnormal loads:

- bridge sections or lengths of railroad track;
- boats
- ...etc.



PROFILE

- Very long trailer chassis, equipped with dual-tire fitments (up to 400 tires on the ground).
- Tractor either independent or fixed to the chassis.

AXLES

Generally multi-axle.

- Each axle has 1 to "n" wheels.
- Most of the axles are steering axles, and some can occasionally be drive axles.

MAXIMUM SPEED

Very slow speed when loaded.

- The return journey (empty) is made in reverse at a faster speed (around twice the loaded speed).
- Loaded: up to 3 mph (5 km/h).
- Empty: up to 9 mph (15 km/h).

Road Trains

MAIN USE

Transporting logs, coal or ore. Outward journey loaded, returning empty, on well-maintained site roads or on public roads.



PROFILE

Vehicles comprising one tractor with two to three multi-axle trailers coupled to it.

AXLES

- The front axle of the tractor always has single-tire fitments.
- One or two rear drive axle(s), generally have dual-tire fitments.

PAYLOAD

Up to 220 U.S. tons (200 tons) (depending on the length of the road train).

MAXIMUM SPEED

50 mph (80 km/h).

Special Intervention Vehicles

MAIN USE

- Airports and other sensitive sites, including various types of military applications.
- Excellent ability to travel over different surfaces.
- Very maneuverable, occasional need for high speed.



AXLES

Three steering and/or drive axles.

MAXIMUM SPEED

81 mph (130 km/h) (for a limited period).



Airport fire truck

GLOSSARY

GLOSSARY

A

ALIGNMENT

Alignment refers to the angle formed by the wheels on one axle (seen from above).

When the wheels are totally parallel, the alignment is correctly adjusted.

AUTOCLAVE

Closed metal container for curing using pressurized steam.

AXLE

Mechanical part linking two wheels (also called rim + tire assemblies). An axle is generally load-bearing. It can be a drive axle (it is then called the live axle), and can also be a steering or tag axle.

The steering axle moves in relation to the chassis of the vehicle.

B

BALL JOINT

Spherical linking component, used as an articulation between two components.

A ball joint can turn in any direction.

BANKING

Raising earth to create or shape a slope or embankment.

BANKING

Incline across the profile of a road on curves.

BEAD

See also the tire diagram under «Casing» in this glossary.

The beads are the two areas of a tire that hold it on the rim.

BEAD SEAT BAND

Detachable metal part of a multi-piece rim used to create a tapered contact area between the tire bead and the rim, to prevent rotation.

Flange: removable metal part of a multi-part rim, the function of which is to support tire bead deformation. On a single-piece rim, the two flanges are integrated into the base of the rim and are therefore known as «hooks»

BEAD SEAT BAND RING

Removable metal part of a 3-piece rim, combining the independent functions of the flange and bead seat band.

BEAD WIRE

Ring generally made up of a series of metal wires inside

each of the two circumferential bases of the tire.

The bead wires of a tire take up all the forces from the casing and transmit them to the rim on which the tire is mounted.

BOGEY

Carriage which moves in relation to the chassis of the vehicle below which it is fixed. The axles (and therefore the wheels) are connected to this chassis.

The main function of the bogies is to assist cornering. A vehicle's bogies can pivot independently of one another, enabling:

- Smaller turning circles;
- Wider spacing between the axles, whether they are drive or bearing axles.

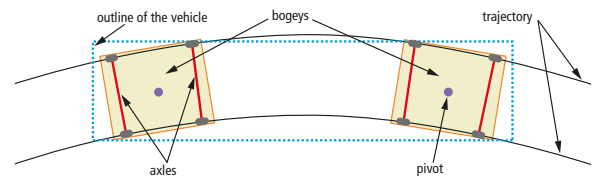

BOLT

Metal component which, together with a nut, attaches the rim or the wheel to the hub.

Reduces the effects of centrifugal force on a moving vehicle.

BOUNCING

Regular movements (jolts) to which a moving machine is subjected when traveling on badly maintained roads (corrugated effect).

C

CALENDERED BAND

Band of rubber for retreading of the correct size for the width of the tire. The band is shaped (width/thickness) by calendaring. This is applied manually.

CALENDERING

Mechanical process consisting of smoothing a malleable material by passing it between two rollers.

CAMBER

Refers to the angle between the center line of the wheel and vertical when viewed from the front. The camber is said to be negative when the top of the wheel tilts toward the vehicle. It is positive when the top of the wheel tilts outward from the vehicle.

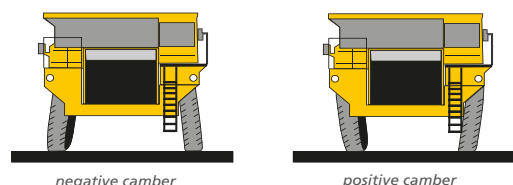

CARDING

Operation involving preparation of the surface of a tire's tread so that the rubber penetrates and adheres during bonding. Carding can be carried out either using a rotating tool, called a carding machine, or by means of various abrasive processes.

CASING

The casing of a tire refers to the entire architecture made up of the various metal or textile plies. The rubber of the tire's tread and sidewalls is applied to the tire's casing.

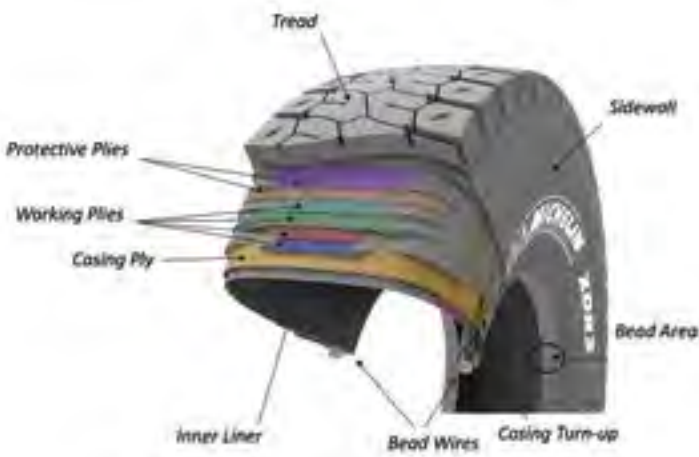

CHAMFER

1. Excess thickness on the bead seat band to enable the airtight seal of the tubeless assembly to be secured.
2. Beveled buffing around the inside edge of a repair to prevent air seeping under a patch.

CHASSIS

Metal structure on which the axles (and thus the wheels) are fixed.

The various axle configurations are denoted by a multiplication:

- The first figure is the number of rim + tire assemblies;
- The second figure is the number of driving assemblies;
- The third figure (optional) is the number of steering assemblies.

Example: 6 x 4 x 2.

CHIPPING

Series of small cuts.

CRACK

Narrow crack found on the braking surface of a brake drum or disk, or on the parts of a worn wheel.

Cracks tend to increase in size under the effects of thermal or mechanical shock.

CROSS-LINKING

Formation of additional links between chains of atoms during curing.

CYCLE

Series of phases carried out by a machine during a loading/unloading operation.

A cycle is made up of four phases:

- loading;
- transport to the unloading point;
- unloading;
- empty return journey.



DRAWBAR

Metal bar by which a trailer (or the vehicle being towed) is coupled to the driving vehicle.



EARTHMOVER

In this Use and Maintenance Guide, the term earthmover covers tires intended for the following uses: mines (surface and underground), quarries, earthmoving and infrastructure sites, road construction, civil engineering, lifting, industrial and port handling activities.



FIFTH WHEEL

Metal component at the rear of truck and bottom dump tractors, sloping towards the trailer.

Designed for fast automatic coupling of a semi-trailer to the tractor.

FLOTATION

Ability of a tire to travel over soft or loose ground without sinking in too much.

Flotation is aided by certain tread patterns and by having a lower air pressure than normal.



GEARBOX

Mechanical device designed to reduce speed.

GRAVEL

Soil on the banks of streams and rivers. Mixture of alluvial soil and stones, which are generally flat and have no sharp edges.

H

HOPPER

Funnel, in the shape of a truncated inverted pyramid, for storing a heavy material (grain, sand, asphalt, etc.) then discharging it under gravity.

I

INSERT

Device inserted inside a tire.

The shapes and materials used are adapted to the conditions of use. A tire with an insert can be used when flat (following a puncture) or even, depending on the insert, be used without being inflated.

J

JACK STAND

Metal support, usually with three feet, used to support a machine that is jacked-up.

K

KEY

Metal pin, generally cross-shaped, inserted into a recess made in the rim base to press it against another other part of the rim.

The key is designed to join the component parts of the rim together, to prevent the rim rotating when the vehicle is moving.

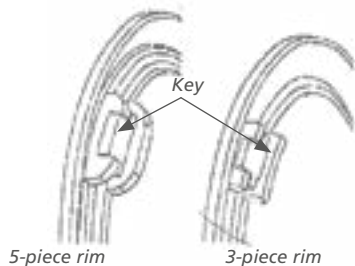

L

LAYERED STRIP

Narrow strip of rubber for retreading, produced by extrusion and applied by winding around in successive layers.

To cover the width of the crown of the tire, each layer is applied, moving this strip sideways while rotating the tire. This is applied automatically.

LIVE AXLE

Set of mechanical components with pins (half-shafts) at each end, which are driven by the engine and on which wheels (rim + tire assemblies) are fitted.

It is commonly referred to as the drive axle. It can be a steering or tag axle.

LOADING AUGER

Metal component consisting of a worm screw wound round a pivot.

The rotation of the pivot enables bulk semi-solid materials to be loaded or unloaded, depending on the direction of rotation.

LOCK RING

Detachable metal part of a multi-piece rim used to hold the other metal assembly parts in place against the tire bead, to prevent the tire becoming detached from the rim.

LOCKING LINK

Metal rod placed between the two parts of an articulated machine in order to immobilize it.

LOCKING ROD

Detachable metal part for locking the two parts of an articulated vehicle together.

LOGGING

Transporting wood between the logging site and the collection or dispatch center.

Transport may take place on unmade tracks and/or on asphalt roads.

LOGS

Tree trunks that have been felled and stripped of their branches. Logs are therefore ready to be transported.

LUG

Lug welded under the rim base to fix the wheel to the vehicle's hub (fixing nut).

M

MILLING

Machining process involving the removal of material.

MOUNTED WHEEL

The mounted wheel is an assembly consisting of the rim and the tire.

The term wheel is commonly used to refer to the whole assembly.

O

O-RING SEAL

Ring-shaped seal, generally made of pressure-molded rubber.

Provides a static and dynamic seal between two cylindrical surfaces.

P

PATCH

Repair piece reinforced with one or more cord plies.

The patch is glued or cured inside a tire after it has been repaired.

PIVOT

Cylindrical linking component used to make another component turn around itself.

POWDER

Any material is said to be powdery if it is in the form of dust or fine crushed grains (powder).

PYROLYSIS

Chemical decomposition of rubber due to an extreme rise in the internal temperature of the tire.

R

REVERSION (REVERSION TEMPERATURE)

Phenomenon which occurs when the temperature of a solid is too high.

Its effect is coarse, incomplete precipitation which may affect the mechanical properties of the solid.

RIM

Set of metal components used to fix the tire on the axle hub and inflate it.

It comprises a rim base, and depending on the type of rim, various other components: side rings, bead seat bands, lock rings.

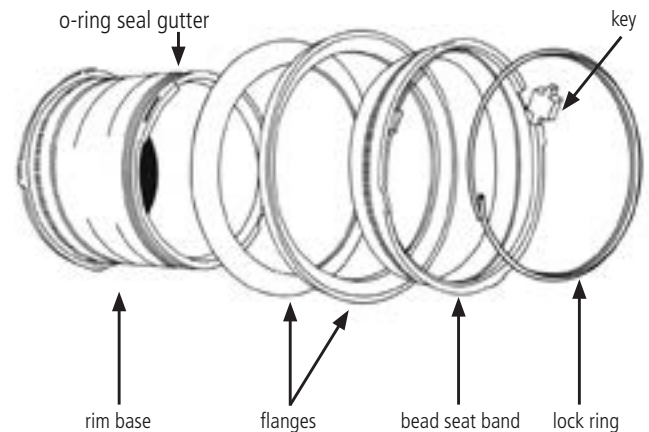

ROAD SURFACING PLANT

Plant manufacturing road coatings (mixture of gravel, sand and bitumen, applied in one or more layers to create road surfaces).

ROLLING DOWN

Action involving running a small handheld roller over a repair patch to ensure perfect bonding between the two rubber surfaces (of the tire and patch).

S

SIPING

Removal tread layer rubber to detach without exceeding the bottom of the sculpture.

See as well: Regrooving

SEAT

Term referring to the area of the rim base on which the base of the tire bead is seated.

SELF-TAPPING SCREW

Screw used to make a hole by cutting a thread in the surrounding material.

SHEAROGRAPHY

Analysis technique for viewing the inside of a tire.

The shearography device is fitted with a laser camera which transmits the internal architecture of the tire onto a screen, so that any deformation or expansion, however small, can be identified.

SPING

Creation of grooves (sipes) in a tread block (without removing any material) to increase tire adhesion on ice or snow-covered surfaces.

SKIVING

Treatment of a damaged area on a tire to remove all the damaged parts (cords, rubber, etc.).

SPINDLE

Tapered end of the axle onto which the hub is fitted.

STEERING ARM

Coupling link (also called steering arm) linking the hub-carriers to the steering rack or the steering cylinder.



T

TANDEM

System replacing the axle, driving two rim + tire assemblies placed one behind the other, and separate from the other lateral rim + tire assemblies.

TANDEM (TANDEM OR PUSH-PULL LOADING)

Combination of two driving machines coupled one behind the other to make use of their cumulative power. The rear vehicle pushes while the front vehicle pulls.

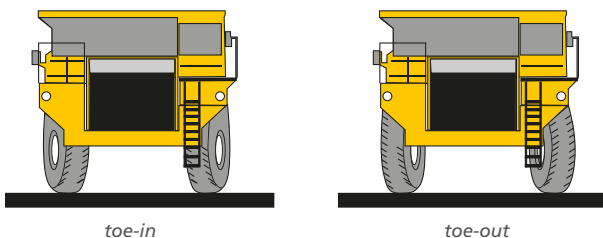

TOE-IN

Toe-in refers to the situation when the distance between the front of the wheels is less than that between the rear of the same wheels.

When the opposite occurs, this is referred to as toe-out.

Toe-in value: value (in the sense of «measurement») of the toe-in angle.

TOE-OUT

See Toe-in.

TORQUE CONVERTER

Generally replaces a mechanical clutch to transfer the power from the drive shaft to the axle.

Also used to vary the torque transmitted when the incoming and outgoing rotation speeds are different.

TPMS (TIRE PRESSURE MONITORING SYSTEM)

System for remotely monitoring the internal pressure and temperature of tires.

A pressure sensor (which can be combined with a temperature sensor) fixed inside the tire transmits information, via a receiver installed in the vehicle, to warning screens located on the vehicle's dashboard and/or to the site's operational control center.

TRACTION

Traction is the ability of the tire to pull the machine. It is aided by certain tread patterns with blocks.

TREAD BLOCK

Block consisting of one of the individual elements of a tread pattern.

A tire's tread pattern is made up of several differently shaped tread blocks, organized in a sequence around the tread and separated by crosswise and lengthwise grooves.

V

VALVE BASE

- Rubber component for fixing a valve on an inner tube.
- Metal component for fixing on the rim base, onto which the valve is screwed, for inflating a tubeless assembly.

W

WHEEL RIM CLAMP

Metal part with holes in it, overlapping one or two of the hub screws on a vehicle in order to attach the rim (single fitment) or the centering ring (dual fitment) on the hub.

NOTES

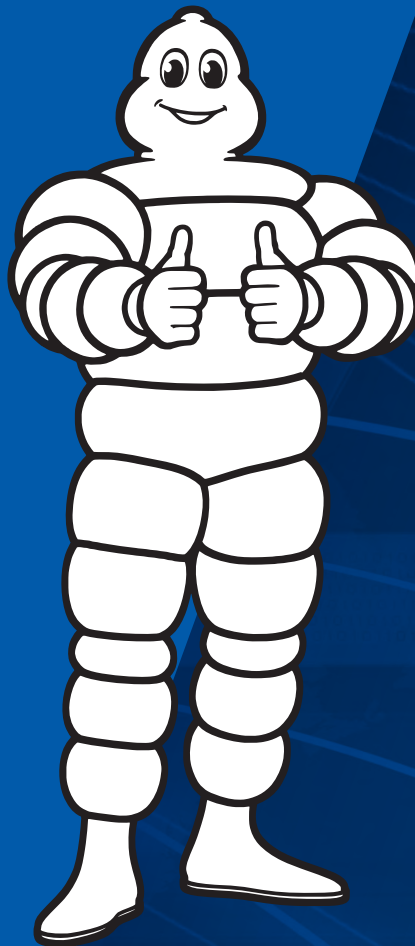

2021
MARCH 2021 EDITION

**MICHELIN EARTHMOVER
USE AND MAINTENANCE GUIDE**

HEADQUARTERS

Manufacture Française des Pneumatiques Michelin
partnership limited by shares with capital of 504 000 004 €
Registered office: Place des Carmes Déchaux - 63040 CLERMONT-FERRAND Cedex 9 - FRANCE
Tel.: +33(0)4 73 32 20 00

855 200 507 RCS Clermont-Ferrand

Copyright © 2021 Michelin North America, Inc. All rights reserved.
The Michelin Man is a registered trademark owned by Michelin.

