



MICHELIN AGRICULTURE

TYRE TECHNICAL DATA BOOK / 2019



 AGRICULTURAL.MICHELIN.CO.UK

 [@MICHELINAGRIUK](https://twitter.com/MICHELINAGRIUK)

 [MICHELIN AGRICULTURE](https://www.youtube.com/MICHELIN AGRICULTURE)



MICHELIN



**MICHELIN
AGRICULTURE**

PAGE 3



**MICHELIN
COMPACT LINE**

PAGE 131

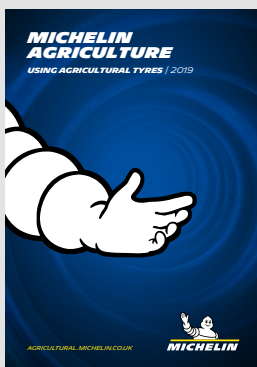

**USING
AGRICULTURAL TYRES**

PAGE 173

MICHELIN AGRICULTURE

TYRE TECHNICAL DATA BOOK | 2019



AGRICULTURAL.MICHELIN.CO.UK

MICHELIN

NOTES

A series of horizontal dotted lines for taking notes, spanning the width of the page.

SUMMARY

READING THE TECHNICAL DATA	6
EQUIVALENCE CHART	7
TYRES BY SIZES	9
ROLLING CIRCUMFERENCE CHART	14
LOAD INDEX	22
NEW LOAD/PRESSURE	23
ZEN@TERRA	24
TRACTORS	25
MICHELIN EVOBIB	25
MICHELIN ROADBIB	28
MICHELIN AXIOBIB 2	30
MICHELIN AXIOBIB	36
MICHELIN MACHXBIB	42
MICHELIN XEOBIB	48
MICHELIN MULTIBIB	52
MICHELIN OMNIBIB	60
MICHELIN YIELDBIB	67
MICHELIN AGRIBIB 2	71
MICHELIN AGRIBIB	77
HARVESTERS & FLOATERS	88
MICHELIN CEREXBIB 2	88
MICHELIN CEREXBIB	94
MICHELIN FLOATXBIB	99
MICHELIN MEGAXBIB 2	101
MICHELIN MEGAXBIB	104
ROW CROP	110
MICHELIN SPRAYBIB	110
MICHELIN AGRIBIB ROW CROP	114
TRAILERS & IMPLEMENTS	118
MICHELIN CARGOXBIB HIGH FLOTATION	118
MICHELIN CARGOXBIB HEAVY DUTY	122
MICHELIN CARGOXBIB	124
MICHELIN XP 27	127
MICHELIN XS	129

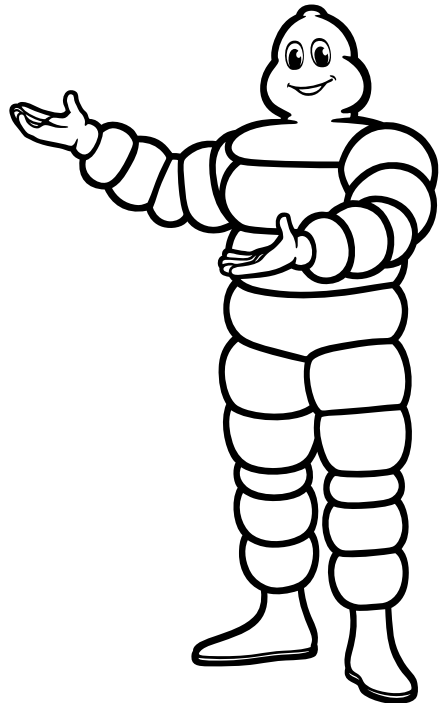

READING THE TECHNICAL DATA

Ø inches	Description	CAI	S mm	OD mm	LR mm	RC mm	Recommended Rim	Acceptable Rim	Tube (Code)	75% internal volume (litres)	Tread depth (mm)
30	VF 540/65 R30 158D/155E TL	296638	536	1460	641	4316	W18L	W16L (NRO)	754	332	48

(TL) Tubeless

Specific markings for very high technology tyres

- **IF: Improved Flexion**
(Tyres designed to operate at 20% higher rated load than standard metric tyres at the same inflation pressure.)
- **VF: Very High Flexion**
(Tyres designed to operate at 40% higher rated load than standard metric tyres at the same inflation pressure.)
- **CFO & CFO+: Improved Flexion Cyclic Field Operation**
(Cyclic Field Operating parameters for IF and VF designated tyres)

Bar	0.4	0.6	0.8	0.9	1	1.1	1.2	1.3	1.4	1.5	1.6	1.7	1.8	1.9	2
Psi	6	9	12	13	15	16	17	19	20	22	23	25	26	28	29
65 km/h		2180	2500	2690	2875	3065	3250	3405	3565	3720	3875	3970	4065	4155	4250
70 km/h		2000	2295	2470	2640	2815	2985	3130	3270	3415	3555	3640	3730	3815	3900
65 km/h Dual		1920	2180	2310	2440	2570	2700	2830	2960	3090	3220	3350	3480	3610	3740

Maximum speed in km/h

Load per tyre in kg



Important notes for tyre use appear at the end of technical data pages for each range.

EQUIVALENCE CHART

STAGE 1

Identify the relevant SRI using the original size.

SRI: «Speed Radius Index» is a parameter used to calculate the theoretical speed of vehicles for homologation procedures by vehicle manufacturers and for the interchangeability of different tyre sizes.

Ø	SIZES	SRI	Ø	SIZES	SRI	Ø	SIZES	SRI	Ø	SIZES	SRI
16	6.50R16	360	26	480/70R26	650	32	210/95R32 (8.3R32)	575	38	580/70R38	875
	7.50R16	390		23.1-26	750		230/95R32 (9.5R32)	600		620/70R38	875
	250/80R16	390		520/80R26	700		270/95R32 (11.2R32)	625		650/65R38	875
	260/70R16	360		540/65R26	650		320/85R32 (12.4R32)	650		650/75R38	925
	280/65R16	360		580/70R26	675		650/75R32 (24.5R32)	825		650/85R38	975
	280/70R16	390		620/70R26	725		680/75R32 (30.5LR32)	875		680/75R38	925
18	320/65R16	390	620/75R26	750	34	680/85R32	925	42	710/60R38	875	
	340/65R18	425	750/50R26	675		800/65R32	875		710/70R38	925	
	7.50R18	410	750/65R26	750		800/70R32	925		710/85R38	1025	
	280/70R18	410	9.5R28	550		900/60R32	925		750/65R38	925	
	320/65R18	410	250/85R28	550		1000/55R32	875		800/70R38	975	
	340/65R18	425	280/85R28 (11.2R28)	575		1050/50R32	875		900/60R38	975	
20	7.50R20	425	320/70R28	575	36	320/85R34	675	44	230/95R40 (9.5R40)	700	
	9.5R20	450	320/85R28 (12.4R28)	600		380/85R34	725		270/95R42 (11.2R42)	750	
	11.2R20	475	340/65R28	550		420/85R34 (16.9R34)	750		300/95R42 (12.4R42)	800	
	12.4R20	500	340/85R28 (13.6R28)	625		460/85R34 (18.4R34)	775		320/90R42	800	
	13.6R20	525	360/70R28	600		480/70R34	750		480/80R42 (18.4R42)	875	
	14.9LR20	525	380/70R28	625		520/70R34	775		520/85R42 (20.8R42)	925	
	260/80R20	450	380/85R28 (14.9R28)	625		520/75R34	775		580/85R42	975	
	280/70R20	425	420/65R28	600		540/65R34	750		620/70R42	925	
	280/85R20	475	420/70R28	650		600/60R34	750		650/65R42	925	
	300/70R20	450	420/75R28	650		600/65R34	775		650/85R42	1025	
	320/70R20	475	420/85R28 (16.9R28)	675		620/75R34	825		710/60R42	925	
	320/85R20	500	440/65R28	625		650/60R34	775		710/70R42	975	
24	340/65R20	450	440/60R28	625	38	650/65R34	825	46	710/75R42	1025	
	340/75R20	525	480/65R28	650		650/75R34	875		900/50R42	925	
	380/70R20	525	480/70R28	675		710/60R34	825		900/60R42	1025	
	420/65R20	500	520/60R28	650		710/75R34	925		210/95R44 (8.3R44)	725	
	440/65R20	525	540/65R28	675		210/95R36 (8.3R36)	625		230/95R44 (9.5R44)	750	
	8.3R24	475	600/60R28	675		230/95R36 (9.5R36)	650		270/95R44 (11.2R44)	775	
	250/85R24 (9.5R24)	500	600/65R28	700		270/95R36 (11.2R36)	675		270/95R46 (11.2R46)	800	
	280/85R24 (11.2R24)	525	600/70R28	725		320/85R36 (12.4R36)	700		300/95R46 (12.4R46)	825	
	300/70R24	500	600/70R28	725		340/85R36 (13.6R36)	725		320/90R46	825	
	320/70R24	525	380/85R30 (14.9R30)	675		270/95R38 (11.2R38)	700		340/85R46 (13.6R46)	825	
	320/85R24 (12.4R24)	550	420/70R30	700		320/85R38 (12.4R38)	725		380/90R46	875	
	340/85R24 (13.6R24)	575	420/90R30	725		340/85R38 (13.6R38)	750		420/80R46	875	
25	360/70R24	550	460/85R30 (18.4R30)	725	380/80R38	750	480/80R46	925			
	380/70R24	575	480/70R30	700	380/95R38	800	520/85R46 (20.8R46)	975			
	380/70R24	575	480/75R30	700	400/75R38 (15.5R38)	850	620/70R46	975			
	380/85R24 (14.9R24)	600	520/70R30	725	420/85R38 (16.9R38)	800	750/75R46	≥ 1075			
	400/70R24	575	520/85R30	775	460/85R38 (18.4R38)	825	900/65R46	≥ 1075			
	420/65R24	550	540/65R30	700	480/70R38	800	230/95R48 (9.5R48)	800			
	420/70R24	600	600/60R30	700	520/70R38	825	270/95R48 (11.2R48)	825			
	420/85R24 (16.9R24)	625	600/65R30	725	520/85R38 (20.8R38)	875	340/85R48 (13.6R48)	875			
	440/65R24	575	600/70R30	750	540/65R38	800	320/90R50	875			
	460/70R24	600	620/70R30	775	600/60R38	800	380/90R50	925			
	480/65R24	600	620/75R30	800	600/65R38	825	420/95R50	975			
	480/70R24	625	650/70R30	800	650/60R38	825	480/80R50	975			
500/70R24	625	710/55R30	725	710/55R30	725	480/95R50	1025				
540/65R24	625	710/60R30	750	710/60R30	750	52	300/95R52 (12.4R52)	925			
1000/50R25	750					54	270/95R54 (11.2R54)	925			
							320/90R54	925			
							380/90R54	975			

EQUIVALENCE CHART

STAGE 2

Based on the SRI obtained, establish the possible tyre size equivalents.

IMPORTANT :

- In no case does the SRI correspond to a specific tread circumference value. Its use in these tables is purely indicative. Verification measurements must be taken.
- Any changes mean you must calculate the axle ratios, evaluate weight distributions and check that the rim widths and diameters are compatible (see technical pages)

SRI	EQUIVALENTS	SRI	EQUIVALENTS	SRI	EQUIVALENTS	SRI	EQUIVALENTS			
360	6.50R16	625	210/95R36 // 8.3R36	750	230/95R44 // 9.5R44	875 (1.85m)	320/90R50			
	260/70R16		270/95R32 // 11.2R32		270/95R42 // 11.2R42		340/85R48 // 13.6R48			
	280/65R16		340/85R28 // 13.6R28		340/85R38 // 13.6R38		380/90R46			
7.50R16	380/70R28		380/80R38		420/80R46					
250/80R16	420/85R24 // 16.9R24		400/75R38 // 15.5R38		480/80R42 // 18.4R42					
280/70R16	440/65R28		420/85R34 // 16.9R34		520/85R38 // 20.8R38					
320/65R16	480/60R28		480/70R34		580/70R38					
7.50R18	480/70R24		540/65R34		620/70R38					
280/70R18	500/70R24		600/60R34		650/65R38					
320/65R18	540/65R24		600/70R30		650/75R34					
410	7.50R20	650	230/95R36 // 9.5R36	775	620/75R26 // 23.1R26	925 (1.95m)	680/75R32 // 30.5LR32			
	280/70R20		320/85R32 // 12.4R32		710/60R30		710/60R38			
	340/65R18		380/85R28 // 14.9R28		750/65R26		800/65R32			
9.5R20	420/70R28		1000/50R25		1000/55R32					
260/80R20	420/75R28		270/95R44 // 11.2R44		1050/50R32					
300/70R20	480/65R28		460/85R34 // 18.4R34		270/95R54 // 11.2R54					
340/65R20	480/70R26		520/85R30		300/95R52 // 12.4R52					
11.2R20	520/60R28		520/70R34		320/90R54					
280/85R20	540/65R26		520/75R34		380/90R50					
320/70R20	270/95R36 // 11.2R36		600/65R34		480/80R46					
8.3R24	320/85R34 // 12.4R34	620/70R30	520/85R42 // 20.8R42							
500	250/85R24 // 9.5R24	675	380/85R30 // 14.9R30	800	650/60R34	975 (2.05m)	620/70R42			
	300/70R24		420/70R30		230/95R48 // 9.5R48		650/65R42			
	320/85R20 // 12.4R24		420/85R28 // 16.9R28		270/95R46 // 11.2R46		650/75R38			
	340/75R20		480/70R28		300/95R42 // 12.4R42		680/75R38			
	360/70R20		540/65R28		320/90R42		680/85R32			
	420/65R20		580/70R26		380/95R38		710/60R42			
525	280/85R24 // 11.2R24		700		600/60R28		825 (1.75m)	420/85R38 // 16.9R38	975 (2.05m)	710/70R38
	320/70R24				750/50R26			480/70R38		710/75R34
	380/70R20				230/95R40 // 9.5R40			540/65R38		750/65R38
	380/75R20 // 13.6R20				270/95R38 // 11.2R38			600/60R38		800/70R32
	14.9LR20	320/85R36 // 12.4R36		620/75R30	900/50R42					
	440/65R20	420/85R30 // 16.9R30		650/70R30	900/60R32					
550	250/85R28 // 9.5R28	725		480/70R30	825 (1.75m)	650/75R30		1025 (2.15m)		380/90R54
	320/85R24 // 12.4R24			480/75R30		270/95R48 // 11.2R48				420/95R50
	340/65R28			520/80R26		300/95R46 // 12.4R46				480/80R50
	360/70R24			540/65R30		320/90R46				520/85R46 // 20.8R46
	420/65R24		600/60R30	340/85R46 // 13.6R46		580/85R42				
	210/95R32 // 8.3R32		600/65R28	460/85R38 // 18.4R38		620/70R46				
575	280/85R28 // 11.2R28		725	210/95R44 // 8.3R44		825 (1.75m)	520/70R38		1025 (2.15m)	650/85R38
	320/70R28			320/85R38 // 12.4R38			600/65R38			710/70R42
	340/85R24 // 13.6R24			340/85R36			620/75R34			800/70R38
	380/70R24			380/85R34			650/75R32 // 24.5R32			900/60R38
	400/70R24	420/90R30		650/65R34	480/95R50					
	440/65R24	460/85R30 // 18.4R30		650/60R38	650/85R42					
600	230/95R32 // 9.5R32	725		520/70R30	825 (1.75m)		710/60R34	1075 (2.30m)		710/75R42
	320/85R28 // 12.4R28			600/65R30			650/75R32			710/85R38
	360/70R28			600/70R28			650/60R34			900/60R42
	380/85R24 // 14.9R24			620/70R26			710/60R34			900/65R46
	420/65R28		710/55R30							
	420/70R24									
460/70R24										
480/65R24										

TYRES BY SIZES

DIAM	DIMENSION	EVOBIB	ROADBIB	AXIOBIB 2	AXIOBIB	MACHXBIB	XEOBIB	MULTIBIB	OMNIBIB	YELDBIB	AGNBIB 2	AGNBIB	CEREXBIB 2	CEREXBIB	FLOATXBIB	MEGAXBIB 2	MEGAXBIB	SPRAYBIB	AGRBIB RC	CARGO HF	CARGO HD	CARGOXBIB	XP27	XS
16	270/65 R16																						x	
16	320/65 R16							x																
18	270/65 R18																							x
18	320/65 R18							x																
18	340/65 R18							x															x	
20	420/65 R20							x																
20	440/65 R20							x																
20.5	24 R 20.5																							x
20.5	525/65 R 20.5																							x
22.5	500/60 R22.5																				x			
22.5	560/45 R22.5																				x			
22.5	560/60 R22.5																				x			
22.5	600/50 R22.5																					x		
22.5	710/45 R22.5																			x				
24	11.2 R24											x												
24	12.4 R24											x												
24	13.6 R24											x												
24	14.9 R24											x												
24	16.9 R24											x												
24	320/70 R24								x															
24	360/70 R24								x															
24	380/70 R24								x															
24	420/65 R24							x																
24	420/70 R24								x															
24	440/65 R24							x																
24	480/65 R24							x																
24	480/70 R24								x															
24	540/65 R24							x																
24	9.5 R24											x												
25	1000/50 R25															x								
26	28 LR 26																				x			
26	520/80 R26												VF	VF										
26	620/70 R26					x							VF	VF										
26	620/75 R26																x							
26	750/50 R26															x	x							
26	750/65 R26												VF	VF			x							
26.5	600/55 R26.5																				x			

TYRES BY SIZES

DIAM	DIMENSION	EVOBIB	ROADBIB	AXIOBIB 2	AXIOBIB	MACHXBIB	XEOBIB	MULTIBIB	OMNIBIB	YELDBIB	AGNBIB 2	AGNBIB	CEREXBIB 2	CEREXBIB	FLOATXBIB	MEGAXBIB 2	MEGAXBIB	SPRAYBIB	AGRBIB RC	CARGO HF	CARGO HD	CARGOXBIB	XP27	XS
26.5	650/55 R26.5																				x			
26.5	710/50 R26.5																				x			
26.5	800/45 R26.5																						x	
28	12.4 R28											x												
28	13.6 R28											x												
28	14.9 R28											x												
28	16.9 R28											x												
28	280/85 R28										x													
28	380/70 R28								x															
28	420/65 R28							x																
28	420/70 R28								x															
28	440/65 R28							x																
28	480/60 R28							VF																
28	480/65 R28							x																
28	480/70 R28								x															
28	520/60 R28							VF																
28	540/65 R28								x															
28	600/60 R28							VF																
28	600/65 R28						x																	
28	600/70 R28						x																	
30	16.9 R30											x												
30	18.4 R30											x												
30	380/85 R30										x	x												
30	420/90 R30										x	x												
30	480/70 R30								x															
30	520/85 R30												VF	VF										
30	540/65 R30				VF				x															
30	600/60 R30				VF			VF																
30	600/70 R30	VF	x	VF	IF	x																		
30	620/70 R30												VF	VF										
30	620/75 R30				VF	IF											x							
30	650/75 R30					IF																		
30	710/55 R30						x																	
30	710/65 R30												VF											
30.5	600/60 R30.5																							x
30.5	650/65 R30.5																				x			
30.5	710/50 R30.5																						x	

TYRES BY SIZES

DIAM	DIMENSION	EVQBIB	ROADBIB	AXIOBIB 2	AXIOBIB	MACHXBIB	XEOBIB	MULTIBIB	OMNIBIB	YELDBIB	AGRIBIB 2	AGRIBIB	CEREXBIB 2	CEREXBIB	FLOATXBIB	MEGAXBIB 2	MEGAXBIB	SPRAYBIB	AGRIBIB RC	CARGO HF	CARGO HD	CARGOXBIB	XP27	XS
30.5	750/60 R30.5																			x				
30.5	800/45 R30.5																						x	
30.5	850/50 R30.5																						x	
32	1000/55 R32													IF	IF									
32	1050/50 R32															x	x							
32	650/75 R32																x							
32	680/75 R32						x																	
32	680/85 R32														IF									
32	800/60 R32																				x			
32	800/65 R32													IF	IF		x							
32	800/70 R32													IF	IF		x							
32	900/60 R32													VF	IF		x							
34	18.4 R34											x												
34	320/85 R34										x	x												
34	380/85 R34								VF	x	x													
34	420/85 R34								VF	x	x													
34	480/70 R34							x																
34	500/85 R34												VF											
34	520/70 R34							x																
34	540/65 R34						x																	
34	600/60 R34					VF																		
34	600/65 R34						x																	
34	620/75 R34																x							
34	650/60 R34				IF																			
34	650/65 R34	VF			IF																			
34	710/60 R34				IF																			
34	710/75 R34																x							
36	12.4 R36											x												
38	12.4 R38											x												
38	13.6 R38											x												
38	18.4 R38											x												
38	20.8 R38											x												
38	320/85 R38																							
38	380/80 R38								VF	x	x													
38	380/95 R38								VF		x													
38	420/85 R38											x												
38	480/70 R38							x																

TYRES BY SIZES

DIAM	DIMENSION	EVOBIB	ROADBIB	AXIOBIB 2	AXIOBIB	MACHXBIB	XEOBIB	MULTIBIB	OMNIBIB	YELDBIB	AGNIBIB 2	AGRIBIB	CEREXBIB 2	CEREXBIB	FLOATXBIB	MEGAXBIB 2	MEGAXBIB	SPRAYBIB	AGRIBIB RC	CARGO HF	CARGO HD	CARGOXBIB	XP27	XS
38	520/70 R38								x															
38	520/85 R38										x	x												
38	540/65 R38							x																
38	580/70 R38								x															
38	600/60 R38						VF																	
38	600/65 R38							x																
38	620/70 R38																x							
38	650/60 R38						VF																	
38	650/65 R38				IF			x																
38	650/75 R38					x																		
38	650/85 R38				IF	x																		
38	680/75 R38																							
38	680/80 R38													IF										
38	710/60 R38				IF		VF																	
38	710/70 R38					x																		
38	710/85 R38				IF																			
38	800/70 R38				IF	x							IF	IF										
38	900/60 R38												VF	IF										
42	320/90 R42																							
42	480/80 R42										x	x						VF						
42	520/85 R42										x	x	VF	VF			x							
42	580/85 R42												VF											
42	620/70 R42								x								x							
42	650/65 R42				VF			x																
42	650/85 R42				VF																			
42	710/60 R42				VF		VF																	
42	710/70 R42	VF	x		IF	x							VF	IF										
42	710/75 R42	VF			IF																			
42	800/70 R42													IF										
42	900/50 R42					x																		
42	900/60 R42				IF								VF											
46	340/85 R46																							
46	380/90 R46																			x				
46	420/80 R46																	VF		x				
46	480/80 R46									VF	x	x												
46	520/85 R46										x	x							VF					
46	620/70 R46					x																		

TYRES BY SIZES

DIAM	DIMENSION	EVOBIB	ROADBIB	AXIOBIB 2	AXIOBIB	MACHXBIB	XEOBIB	MULTIBIB	OMNIBIB	YELDBIB	AGRIBIB 2	AGRIBIB	CEREXBIB 2	CEREXBIB	FLOATXBIB	MEGAXBIB 2	MEGAXBIB	SPRAYBIB	AGRIBIB RC	CARGO HF	CARGO HD	CARGOXBIB	XP27	XS
46	750/75 R46				IF																			
46	900/65 R46				IF																			
50	320/90 R50																		x					
50	380/90 R50																	VF	x					
50	420/95 R50																	VF						
50	480/80 R50									VF	x	x						VF						
50	480/95 R50									VF		x												
54	320/90 R54																		x					
54	380/90 R54										x							VF						

ROLLING CIRCUMFERENCE CHART

TYRE SIZE AND RANGE	CAI	MSPN	Minimum Dual Spacing		Tyre Diameter		Rolling Circumference		RCI	SRI
			mm	inches	mm	inches	mm	inches		
210/70 R15 117A8/117B IND TL BIBSTEEL AT	085459	20011	308	12.1	680	26.8	2033	80.0		320
270/65 R16 134A8/122A8 TL XP27	184332	4629	369	14.5	755	29.7	2300	90.6		360
260/70 R16.5 129A8/129B IND TL BIBSTEEL HS	275538	38281	364	14.3	773	30.4	2307	90.8		370
260/70 R16.5 129A8/129B IND TL BIBSTEEL AT	176281	19038	364	14.3	774	30.5	2310	90.9		370
250/80 R16 124A8/120D IND TL CROSSGRIP	564847	97221	352	13.9	804	31.7	2402	94.6		390
280/70 R 16 112D TL OMNIBIB	747196		389	15.3	805	31.7	2400	94.5	30	390
270/65 R18 136A8/124A8 TL XP27	133069	98595	369	14.5	810	31.9	2472	97.3		390
320/65 R16 107D TL MULTIBIB	494658	39517	410	16.1	827	32.6	2452	96.5		390
300/70 R16.5 137A8/137B IND TL BIBSTEEL HS	241265	84590	414	16.3	830	32.7	2477	97.5		400
300/70 R16.5 137A8/137B IND TL BIBSTEEL AT	625787	34034	414	16.3	832	32.8	2481	97.7		400
11 LR16 122A8 IND TL XM27	123207	13902	386	15.2	850	33.5	2515	99.0		
320/65 R18 109A8/106B TL XM108	123898	78520	422	16.6	875	34.4	2594	102.1		410
340/65 R18 149A8/137A8 TL XP27	415969	8185	462	18.2	891	35.1	2720	107.1		425
280/80 -18 132A8 IND TL POWER CL	281778	38882	348	13.7	902	35.5	2691	105.9		425
280/70 R20 116D TL OMNIBIB	263806		389	15.3	904	35.6	2690	105.9	32	450
280/80 R18 132A8/132B IND TL XMCL	779803	25391	389	15.3	908	35.7	2708	106.6		425
340/65 R18 113A8/110B TL XM108	123888	79647	438	17.2	911	35.9	2719	107.0	32	425
280/80 -20 133A8 IND TL POWER CL	694767	28486	348	13.7	947	37.3	2828	111.3		450
360/70 R17.5 148A8/148B IND TL BIBSTEEL AT	360353	17395	472	18.6	949	37.4	2823	111.1	33	450
280/80 R20 133A8/133B IND TL XMCL	747442	32621	389	15.3	958	37.7	2860	112.6		450
340/80 R18 143A8/143B IND TL BIBLOAD HS	415829	66605	462	18.2	990	39.0	2946	116.0		475
340/80 R18 143A8/143B IND TL XMCL	100054	24643	462	18.2	996	39.2	2959	116.5		475
400/70 R18 147A8/147B IND TL BIBLOAD HS	239365	9464	536	21.1	1006	39.6	2983	117.4		475
340/80 -18 143A8 IND TL POWER CL	610873	4967	415	16.3	1006	39.6	2988	117.6		475
400/70 R18 147A8/147B IND TL XMCL	133035	39817	536	21.1	1013	39.9	3008	118.4		475
340/80 R20 144A8/144B IND TL BIBLOAD HS	991253	23767	462	18.2	1041	41.0	3100	122.0		500
9.5 R24 112A8/109B TL AGRIBIB	200987		340	13.4	1045	41.1	3117	122.7	35	500
340/80 -20 144A8 IND TL POWER CL	495503	56730	415	16.3	1045	41.1	3112	122.5		500
340/80 R20 144A8/144B IND TL XMCL	948730	733	462	18.2	1047	41.2	3119	122.8		500
10.00-20 165A2/147B 16PR TT POWER DIGGER	263208	03227	341	13.4	1050	41.3	3144	123.8		
420/65 R20 125A8/125B TL XM108	122702	86582	528	20.8	1064	41.9	3135	123.4	35	500
400/70 -20 149A8 IND TL POWER CL	346809	18007	483	19.0	1065	41.9	3167	124.7		525
400/70 R20 149A8/149B IND TL BIBLOAD HS	793611	18143	536	21.1	1068	42.0	3174	125.0		525
400/70 R20 149A8/149B IND TL XMCL	474495	2871	536	21.1	1069	42.1	3177	125.1		525
380/75 R20 148A8/148B IND TL XMCL	187752	3424	507	20.0	1070	42.1	3180	125.2		525
405/70 R20 136G TL XM47	123708	43043	515	20.3	1076	42.4	3194	125.7		
560/45 R22.5 152D TL CARGOXBIB HD	743789	27334	702	27.6	1080	42.5	3191	125.6		525

ROLLING CIRCUMFERENCE CHART

TYRE SIZE AND RANGE	CAI	MSPN	Minimum Dual Spacing		Tyre Diameter		Rolling Circumference		RCI	SRI
			mm	inches	mm	inches	mm	inches		
			440/65 R20 128D TL MULTIBIB	675464	15810	580	22.8	1090		
11.2 R24 119A8/116B TL AGRIBIB	317247	92311	392	15.4	1095	43.1	3269	128.7	36	525
320/70 R24 116D TL OMNIBIB	415039	25416	434	17.1	1101	43.3	3274	128.9		525
445/70 R19.5 173A8/180A2 TL XF	489102	81617	585	23.0	1110	43.7	3331	131.1		
420/75 R20 154A8/154B IND TL XMCL	967201	19152	552	21.7	1138	44.8	3378	133.0		550
425/75 R20 148G TL XM47	123706	75328	556	21.9	1147	45.2	3398	133.8		
12.4 R24 119A8/116B TL AGRIBIB	123788	78449	429	16.9	1149	45.2	3420	134.6	37	550
360/70 R24 122D TL OMNIBIB	198698	45416	479	18.9	1153	45.4	3418	134.6	37	550
420/65 R 24 126D TL MULTIBIB	171560		540	21.3	1156	45.5	3416	134.5	37	550
420/65 R24 126A8/126B TL XM108	122712	77842	528	20.8	1160	45.7	3425	134.8	37	550
400/70 R24 152A8/152B IND TL XMCL	178690	92225	536	21.1	1170	46.1	3485	137.2	37	575
500/60 R22.5 155D TL CARGOXBIB HD	441880	36343	654	25.7	1172	46.1	3454	136.0		550
400/70 -24 158A8 IND TL POWER CL	407878	60752	483	19.0	1173	46.2	3497	137.7	37	575
600/50 R22.5 159D TL CARGOXBIB	048429	94336	784	30.9	1181	46.5	3478	136.9		550
440/65 R24 128D TL MULTIBIB	426389	4039	580	22.8	1187	46.7	3519	138.5		575
380/70 R24 125D TL OMNIBIB	085816	64778	507	20.0	1188	46.8	3520	138.6	38	575
445/70 R22.5 175A8/182A2 TL XF	073522	33819	585	23.0	1192	46.9	3582	141.0		
280/85 R28 123A8/120D TL AGRIBIB 2	392931	40217	401	15.8	1192	46.9	3563	140.3		575
525/65 R 20.5 XS TL 173F MI	109421	71848	687	27.0	1200	47.2	3640	143.3		575
13.6 R24 124A8/121B TL AGRIBIB	262831	06247	465	18.3	1200	47.2	3583	141.1	38	575
710/45 R22.5 165D TL CARGOXBIB HF	723051	6153	922	36.3	1208	47.6	3545	139.6		575
420/65 R28 135D TL MULTIBIB	778211	62700	528	20.8	1238	48.7	3680	144.9		600
445/70 R24 151G TL XM47	123642	45627	597	23.5	1239	48.8	3689	145.2		
480/65 R24 133D TL MULTIBIB	531721	3176	626	24.6	1240	48.8	3667	144.4	38	600
400/80 R24 156A8/151D IND TL CROSSGRIP	920345	76135	536	21.1	1240	48.8	3747	147.5		600
460/70 R24 159A8/159B IND TL BIBLOAD HS	372690	27534	609	24.0	1241	48.9	3688	145.2		600
460/70 -24 159A8 IND TL POWER CL	474764	86617	550	21.7	1241	48.9	3687	145.2		600
560/60 R22.5 161D TL CARGOXBIB HD	102433	20379	704	27.7	1242	48.9	3650	143.7		600
460/70 R24 159A8/154D IND TL CROSSGRIP	304047	11050	609	24.0	1246	49.1	3772	148.5		600
460/70 R24 159A8/159B IND TL XMCL	244268	70333	609	24.0	1248	49.1	3709	146.0		600
420/70 R24 130D TL OMNIBIB	829095	28067	552	21.7	1251	49.3	3702	145.7	39	600
400/80 -24 162A8 IND TL POWER CL	050267	53837	483	19.0	1257	49.5	3743	147.4		600
14.9 R24 130A8/127B TL AGRIBIB	601563	92158	504	19.8	1265	49.8	3769	148.4	39	600
12.4 R28 126A8/123B TL AGRIBIB	738964	20895	429	16.9	1265	49.8	3778	148.7		600
440/65 R28 131D TL MULTIBIB	386212	96372	580	22.8	1291	50.8	3833	150.9	39	625
380/70 R28 127D TL OMNIBIB	118587	24723	507	20.0	1294	50.9	3842	151.3	39	625
VF 480/60 R28 134D TL XEOBIB	312875	80140	615	24.2	1298	51.1	3831	150.8	39	625

ROLLING CIRCUMFERENCE CHART

TYRE SIZE AND RANGE	CAI	MSPN	Minimum Dual Spacing		Tyre Diameter		Rolling Circumference		RCI	SRI
			mm	inches	mm	inches	mm	inches		
500/70 R24 164A8/164B IND TL BIBLOAD HS	346709	19122	654	25.7	1299	51.1	3874	152.5		625
440/80 R24 161A8/161B IND TL BIBLOAD HS	814805	23762	580	22.8	1299	51.1	3860	152.0		625
500/70 R24 164A8/164B IND TL XMCL	542794	89582	654	25.7	1302	51.3	3866	152.2		625
13.6 R28 123A8/120B TL AGRIBIB	123782	87976	465	18.3	1308	51.5	3893	153.3	39	625
495/70 R24 155G TL XM47	123620	88892	650	25.6	1311	51.6	3883	152.9		
540/65 R24 140D TL MULTIBIB	097057	8801	687	27.0	1312	51.7	3873	152.5		625
440/80 R24 161A8/156D IND TL CROSSGRIP	131846	74806	580	22.8	1314	51.7	3977	156.6		625
440/80 R24 161A8/161B IND TL XMCL	954749	34933	580	22.8	1314	51.7	3907	153.8		625
500/70 -24 164A8 IND TL POWER CL	196220	6567	591	23.3	1315	51.8	3903	153.7		625
480/70 R24 138D TL OMNIBIB	375821	02475	626	24.6	1327	52.2	3916	154.2		625
440/80 -24 168A8 IND TL POWER CL	165629	56443	523	20.6	1328	52.3	3944	155.3		625
16.9 R24 134A8/131B TL AGRIBIB	123854	97341	566	22.3	1330	52.4	3935	154.9		625
VF 520/60 R28 138D TL XEOBIB	510495	80236	670	26.4	1338	52.7	3942	155.2	40	650
480/65 R28 136D TL MULTIBIB	897574	14369	626	24.6	1339	52.7	3970	156.3		650
540/70 R24 168A8/168B IND TL BIBLOAD HS	005412	34928	711	28.0	1341	52.8	3981	156.7	40	650
600/55 R26.5 165D TL CARGOXBIB HF	550621	32505	784	30.9	1341	52.8	3954	155.7		625
400/80 R28 158A8/153D IND TL CROSSGRIP	219659	38141	536	21.1	1354	53.3	4094	161.2	40	650
420/70 R28 133D TL OMNIBIB	532215	25705	552	21.7	1354	53.3	4012	158.0	40	650
540/70 R24 168A8/168B IND TL XMCL	959128	58268	711	28.0	1356	53.4	4026	158.5	40	650
14.9 R28 134A8/131B TL AGRIBIB	112235	25543	504	19.8	1365	53.7	4072	160.3	40	650
24 R 20.5 XS TL 176F MI	109174	44650	778	30.6	1374	54.1	4148	163.3		650
710/50 R26.5 170D TL CARGOXBIB HF	892516	29880	922	36.3	1380	54.3	4061	159.9		650
800/45 R26.5 174D TL CARGOXBIB	248959	81371	996	39.2	1395	54.9	4097	161.3		675
650/55 R26.5 169D TL CARGOXBIB HF	693431	15666	825	32.5	1402	55.2	4158	163.7		725
750/50 R26 160A8/154D TL MEGAXBIB 2	236906	81321	968	38.1	1406	55.4	4171	164.2	41	675
440/80 R28 163A8/163B IND TL BIBLOAD HS	195802	49461	580	22.8	1407	55.4	4188	164.9		675
440/80 R28 156A8/156B IND TL XMCL	316223	94482	580	22.8	1410	55.5	4200	165.4		675
440/80 R28 163A8/158D IND TL CROSSGRIP	439765	52613	580	22.8	1410	55.5	4283	168.6		675
440/80-28 163 A8 TL POWER CL	691578	95541	534	21.0	1412	55.6	4201	165.4		675
380/85 R30 140A8/140B TL AGRIBIB 2	151572	72163	519	20.4	1416	55.7	4219	166.1	41	675
480/80 -26 167A8 IND TL POWER CL	226486	32114	576	22.7	1417	55.8	4211	165.8		675
480/80 R26 167A8/167B IND TL BIBLOAD HS	886709	46166	638	25.1	1419	55.9	4215	165.9		675
320/85 R34 133A8/133B TL AGRIBIB 2	908266		434	17.1	1421	55.9	4243	167.0	41	675
480/80 R26 167A8/167B IND TL XMCL	425979	22312	626	24.6	1422	56.0	4218	166.1		675
480/70 R28 140D TL OMNIBIB	570026	27084	626	24.6	1427	56.2	4217	166.0	41	675
540/65 R28 142D TL MULTIBIB	792274	36062	687	27.0	1427	56.2	4223	166.3	41	675
VF 600/60 R28 146D TL XEOBIB	665184	80297	755	29.7	1429	56.3	4198	165.3	41	675

ROLLING CIRCUMFERENCE CHART

TYRE SIZE AND RANGE	CAI	MSPN	Minimum Dual Spacing		Tyre Diameter		Rolling Circumference		RCI	SRI
			mm	inches	mm	inches	mm	inches		
			420/80 -30 155A8 IND TL POWER CL	577845	29803	520	20.5	1432		
16.9 R28 141A8/138B TL AGRIBIB	984997	13991	566	22.3	1435	56.5	4278	168.4	41	675
12.4 R36 124A8/121B TL AGRIBIB	123952	3338	429	16.9	1460	57.5	4363	171.8	41	700
VF 540/65 R30 158D/155E TL AXIOBIB 2	296638	06869	686	27.0	1460	57.5	4316	169.9		700
VF 600/60 R30 162D/159E TL AXIOBIB 2	371968	06116	755	29.7	1468	57.8	4336	170.7	42	700
540/65 R30 143D TL MULTIBIB	223153	28553	687	27.0	1472	58.0	4353	171.4		700
16.9 R30 137A8/134B TL AGRIBIB	123870	41545	566	22.3	1480	58.3	4395	173.0	42	700
480/70 R30 141D TL OMNIBIB	599351	27236	626	24.6	1482	58.3	4388	172.8	42	700
VF 520/80 R26 CFO+ 168A8 TL CEREXBIB 2	850494	24394	658	25.9	1491	58.7	4400	173.2		700
VF 600/60 R30 147D TL XEOBIB	065253	3690	755	29.7	1493	58.8	4379	172.4	42	700
710/50 R30.5 173D TL CARGOXBIB	002786	92209	922	36.3	1495	58.9	4408	173.5		700
800/45 R30.5 176D TL CARGOXBIB	932951	53255	1044	41.1	1495	58.9	4408	173.5		725
600/60 R30.5 169D TL CARGOXBIB	236518	51915	755	29.7	1496	58.9	4417	173.9		700
12.4 R38 131A8/128B TL AGRIBIB	258138	15336	429	16.9	1500	59.1	4484	176.5	42	725
600/65 R28 154D TL MACHXBIB	055335	30734	784	30.9	1502	59.1	4449	175.2	42	700
320/85 R38 143A8/143B TL AGRIBIB RC	758001	50528	434	17.1	1508	59.4	4514	177.7	42	725
VF 380/85 R34 149A8/149B TL YELDBIB	305457	91239	498	19.6	1510	59.4	4471	176.0	42	725
VF 620/70 R26 CFO+ 173A8 TL CEREXBIB 2	228272	98039	778	30.6	1513	59.6	4461	175.6	42	725
380/85 R34 142A8/142B TL AGRIBIB 2	009860	84143	519	20.4	1516.4	59.7	4519	177.9	42	725
420/90 R30 147A8/147B TL AGRIBIB 2	508522	71308	552	21.7	1518	59.8	4513	177.7	42	700
710/55 R30 153D TL MACHXBIB	992342	3784	910	35.8	1518	59.8	4489	176.7		725
18.4 R30 142A8/139B TL AGRIBIB	123844	42060	611	24.1	1550	61.0	4602	181.2		725
13.6 R38 128A8/125B TL AGRIBIB	123992	66666	465	18.3	1565	61.6	4705	185.2	43	750
600/70 R30 158D/155E TL ROADBIB	217911	15131	784	30.9	1569	61.8	4630	182.3	43	750
600/70 R28 157D TL MACHXBIB	438598	4339	784	30.9	1572	61.9	4663	183.6	0	725
VF 600/70 R30 165D TL EVOBIB	266793	84559	774	30.5	1574	62.0	4616	181.7		750
540/65 R34 145D TL MULTIBIB	712064	22243	687	27.0	1574	62.0	4655	183.3	43	750
VF 600/70 R30 168D/165E TL AXIOBIB 2	426719	32376	774	30.5	1579	62.2	4659	183.4		750
28 LR 26 175D TL CARGOXBIB HF	224829		908	35.7	1581	62.2	4685	184.4	43	
VF 420/85 R34 154A8/154B TL YELDBIB	012445	58965	566	22.3	1582	62.3	4682	184.3	43	750
IF 600/70 R30 159D TL AXIOBIB	280086	96393	774	30.5	1585	62.4	4683	184.4	43	750
420/85 R34 147A8/147B TL AGRIBIB 2	183733	16801	576	22.7	1589	62.6	4730	186.2	43	750
540/65 R34 152D TL MULTIBIB	214036	99445	687	27.0	1590	62.6	4716	185.7	43	750
VF 380/80 R38 149A8/149B TL YELDBIB	870363	35470	498	19.6	1592	62.7	4851	191.0	43	750
480/70 R34 143D TL OMNIBIB	280033	25021	626	24.6	1593	62.7	4728	186.1	43	750
380/80 R38 142A8/139D TL AGRIBIB 2	187095	59112	507	20.0	1595	62.8	4755	187.2	43	750
VF 600/60 R34 149D TL XEOBIB	664777	78329	755	29.7	1595	62.8	4699	185.0	43	750

ROLLING CIRCUMFERENCE CHART

TYRE SIZE AND RANGE	CAI	MSPN	Minimum Dual Spacing		Tyre Diameter		Rolling Circumference		RCI	SRI
			mm	inches	mm	inches	mm	inches		
620/75 R26 166A8/166B TL MEGAXBIB	614320	89936	801	31.5	1602	63.1	4748	186.9	43	750
600/70 R30 TL 152D MACHXBIB	334318	76077	784	30.9	1605	63.2	4745	186.8	43	750
VF 620/70 R30 CFO+ 175A8 TL CEREXBIB 2	049288	53106	778	30.6	1615	63.6	4765	187.6		775
750/65 R26 171A8/171B TL MEGAXBIB	983217	36798	968	38.1	1621	63.8	4818	189.7		750
650/65 R30.5 176D TL CARGOXBIB HF	139310	28171	825	32.5	1622	63.9	4776	188.0		775
VF 750/65 R26 CFO+ 180A8 TL CEREXBIB 2	132266	33777	932	36.7	1623	63.9	4786	188.4		750
VF 520/85 R30 CFO+ 172A8 TL CEREXBIB 2	188276	86907	658	25.9	1624	63.9	4797	188.9	46	775
850/50 R30.5 182D TL CARGOXBIB	938016	69986	1085	42.7	1628	64.1	4778	188.1		775
VF 320/90 R42 163D TL SPRAYBIB	920383		438	17.2	1634.5	64.4	4890	192.5	44	800
320/90 R42 147A8/147B TL AGRIBIB RC	425361	64720	434	17.1	1638	64.5	4908	193.2	44	800
520/70 R34 148D TL OMNIBIB	939411	29601	652	25.7	1651	65.0	4887	192.4	44	775
VF 650/60 R34 168D/165E TL AXIOBIB 2	202185		831	32.7	1653	65.1	4895	192.7		775
600/65 R34 151D TL MULTIBIB	557189	16291	760	29.9	1654	65.1	4897	192.8	44	775
1000/50 R25 172A8/166D TL MEGAXBIB 2	852423	76362	1306	51.4	1654	65.1	4907	193.2		750
IF 650/60 R34 165D TL AXIOBIB	100511	94599	807	31.8	1661	65.4	4933	194.2		775
18.4 R34 149A8/146B TL AGRIBIB	679786	71754	611	24.1	1662	65.4	4940	194.5	44	775
650/60 R34 159D/155E TL MACHXBIB	549996		837	33.0	1663	65.5	4944	194.6		775
IF 620/75 R30 164D TL AXIOBIB	668406	96772	814	32.0	1670	65.7	4927	194.0	44	800
VF 620/75 R30 172D/169E TL AXIOBIB 2	702894	20861	814	32.0	1670	65.7	4919	193.7	44	800
750/60 R30.5 181D TL CARGOXBIB HF	101332	77049	956	37.6	1675	65.9	4936	194.3		800
540/65 R38 147D TL MULTIBIB	114518	28857	687	27.0	1675	65.9	4965	195.5	44	800
VF 500/85 R34 CFO+ 172A8 TL CEREXBIB2	038009	29877	642	25.3	1676	66.0	4961	195.3		825
420/85 R38 144A8/144B TL AGRIBIB	607820	84239	576	22.7	1676	66.0	4975	195.9	44	800
VF 710/65 R30 CFO+ 179A8 TL CEREXBIB2	608814	22560	876	34.5	1676	66.0	4952	195.0		800
380/95 R38 147A8/147B TL AGRIBIB	836033	65207	507	20.0	1689	66.5	5034	198.2		800
420/85 R38 149A8/149B TL AGRIBIB 2	048439		576	22.7	1690	66.5	5035	198.2	44	800
480/70 R38 145D TL OMNIBIB	936570	28503	626	24.6	1694	66.7	5030	198.0	44	800
IF 710/60 R34 164D TL AXIOBIB	712503	67777	900	35.4	1696	66.8	5030	198.0		825
VF 600/60 R38 151D TL XEOBIB	349257	80626	755	29.7	1698	66.9	5023	197.8	44	800
VF 380/95 R38 154A8/154B TL YELDBIB	873023	47225	510	20.1	1703	67.0	5044	198.6	44	800
VF 650/65 R34 167D TL EVOBIB	262107	73467	831	32.7	1707	67.2	5032	198.1		825
VF 650/65 R34 170D/167E TL AXIOBIB 2	101906		831	32.7	1710	67.3	5061	199.3		825
620/75 R30 168A8/168B TL MEGAXBIB	753673	63928	801	31.5	1710	67.3	5083	200.1	44	800
IF 650/65 R34 161D TL AXIOBIB	711975	26241	831	32.7	1721	67.8	5099	200.7		825
IF 650/75 R30 166D TL AXIOBIB	828322	96826	838	33.0	1721	67.8	5071	199.6	45	825
650/65 R34 161D/157E TL MACHXBIB	817386		837	33.0	1723	67.8	5125	201.8		825
VF 650/60 R38 155D TL XEOBIB	454365	80851	831	32.7	1735	68.3	5108	201.1	45	825

ROLLING CIRCUMFERENCE CHART

TYRE SIZE AND RANGE	CAI	MSPN	Minimum Dual Spacing		Tyre Diameter		Rolling Circumference		RCI	SRI
			mm	inches	mm	inches	mm	inches		
			VF 650/60 R38 170D/167E TL AXIOBIB 2	908973		831	32.7	1742		
340/85 R46 150A8/150B TL AGRIBIB RC	846786	94547	462	18.2	1747	68.8	5227	205.8	45	825
480/80 R38 166A8/161D IND TL CROSSGRIP	846732		626	24.6	1751	68.9	5272	207.6		825
520/70 R38 150D TL OMNIBIB	833744	28089	670	26.4	1766	69.5	5229	205.9	45	825
600/65 R38 153D TL MULTIBIB	228045	29767	760	29.9	1768	69.6	5229	205.9	45	825
18.4 R38 151A8/148B TL AGRIBIB	100097	63603	611	24.1	1770	69.7	5267	207.4	45	825
800/60 R32 185D IMP TL CARGOXBIB HF	322432		1032	40.6	1800	70.9	5300	208.7		875
VF 710/60 R38 160D TL XEOBIB	324138	81759	900	35.4	1814	71.4	5356	210.9	46	875
620/75 R34 170A8/170B TL MEGAXBIB	325025	83734	801	31.5	1814	71.4	5398	212.5		825
650/65 R38 157D TL MULTIBIB	292904	12871	825	32.5	1819	71.6	5380	211.8	46	875
650/75 R32 172A8/172B TL MEGAXBIB	468227	46686	837	33.0	1825	71.9	5423	213.5	45	875
IF 650/65 R38 169D TL AXIOBIB	508421	87017	831	32.7	1826	71.9	5446	214.4		875
580/70 R38 155D TL OMNIBIB	001240	31198	743	29.3	1836	72.3	5440	214.2	46	875
VF 480/80 R42 176D TL SPRAYBIB	929553	13814	626	24.6	1838	72.4	5471	215.4	46	875
800/65 R32 178A8/178B TL MEGAXBIB 2	135425		1032	40.6	1839	72.4	5471	215.4	46	875
800/65 R32 178A8/178B TL MEGAXBIB	521809	49342	1032	40.6	1840	72.4	5459	214.9	46	875
480/80 R42 156A8/156B TL AGRIBIB 2	539386	05745	638	25.1	1840	72.4	5470	215.4	46	875
VF 380/90 R46 173D TL SPRAYBIB	198604	27358	510	20.1	1842	72.5	5530	217.7	46	925
IF 710/60 R38 172D TL AXIOBIB	220975	69189	900	35.4	1844	72.6	5486	216.0		875
320/90 R50 150A8/150B TL AGRIBIB RC	130813	95098	434	17.1	1847	72.7	5539	218.1	46	925
520/85 R38 160A8/160B TL AGRIBIB 2	882358	05183	670	26.4	1849	72.8	5493	216.3	46	875
20.8 R38 159A8/156B TL AGRIBIB	813266	17548	684	26.9	1850	72.8	5506	216.8	46	875
VF 320/90 R50 166D TL SPRAYBIB	946508		438	17.2	1850	72.8	5682	223.7	46	925
420/80 R46 151A8/151B TL AGRIBIB 2	885138		552	21.7	1854	73.0	5524	217.5	46	925
IF 800/65 R32 CFO+ 181A8 TL CEREXBIB2	987406	25367	994	39.1	1855	73.0	5501	216.6	46	875
1050/50 R32 184A8/184B TL MEGAXBIB T2	829536	28613	1346	53.0	1856	73.1	5510	216.9	46	875
620/70 R38 170A8/170B TL MEGAXBIB	476088	99512	801	31.5	1864	73.4	5557	218.8	46	875
380/90 R46 157A8/157B TL AGRIBIB RC	799905	38865	519	20.4	1864	73.4	5583	219.8	46	925
680/75 R32 164A8/161B TL XM28	123582	80305	862	33.9	1865	73.4	5512	217.0	46	875
1050/50 R32 178A8/172D TL MEGAXBIB 2	424273	12011	1346	53.0	1866	73.5	5537	218.0	46	875
IF 1000/55 R32 CFO 191D/188E TL FLOATXBIB	564739		1258	49.5	1877	73.9	5540	218.1		925
VF 710/60 R42 176D/173E TL AXIOBIB 2	941770	78256	900	35.4	1885.3	74.2	5574	219.4	47	925
900/60 R32 181A8/181B TL MEGAXBIB	824122	40581	1114	43.9	1894	74.6	5626	221.5	46	925
900/60 R32 181A8/181B TL MEGAXBIB 2	166896		1114	43.9	1899	74.8	5635	221.9	46	925
710/75 R34 178A8/178B TL MEGAXBIB	543107	13589	910	35.8	1900	74.8	5637	221.9	47	925
1050/50 R32 178A8 TL MEGAXBIB M28	236234	94737	1346	53.0	1902	74.9	5649	222.4	46	875
VF 900/60 R32 CFO+ 191A8 TL CEREXBIB 2	430737	73624	1108	43.6	1903	74.9	5618	221.2		925

ROLLING CIRCUMFERENCE CHART

TYRE SIZE AND RANGE	CAI	MSPN	Minimum Dual Spacing		Tyre Diameter		Rolling Circumference		RCI	SRI
			mm	inches	mm	inches	mm	inches		
VF 710/60 R42 161D TL XEOBIB	144294	94391	900	35.4	1920	75.6	5675	223.4	47	925
VF 650/65 R42 174D/171E TL AXIOBIB 2	387916	43835	831	32.7	1920	75.6	5680	223.6	47	925
IF 1000/55 R32 CFO 188A8 TL CEREXBIB	131720	22858	1258	49.5	1931	76.0	5758	226.7		925
650/65 R42 158D TL MULTIBIB	167733		825	32.5	1931	76.0	5722	225.3	47	925
VF 480/80 R46 164A8/164B TL YELDBIB	842300	10807	626	24.6	1933	76.1	5732	225.7	47	925
380/90 R50 151A8/151B TL AGRIBIB RC	036849	15852	519	20.4	1935	76.2	5813	228.9	47	975
IF 680/85 R32 CFO 179A8 TL CEREXBIB	932041	18128	869	34.2	1935	76.2	5711	224.8	47	925
800/70 R32 181A8/181B TL MEGAXBIB	695992	68880	1032	40.6	1936	76.2	5725	225.4		925
520/85 R42 162A8/162B TL MEGAXBIB	645194	15488	694	27.3	1937	76.3	5783	227.7	47	925
VF 480/80 R46 177D TL SPRAYBIB	159186	21151	626	24.6	1943	76.5	5790	228.0	47	925
480/80 R46 158A8/158B TL AGRIBIB 2	622709	00639	638	25.1	1945	76.6	5804	228.5	47	925
650/75 R38 169A8/169B TL MACHXBIB	219467	86829	861	33.9	1948	76.7	5761	226.8	47	925
VF 320/90 R54 168D TL SPRAYBIB	044008		438	17.2	1950	76.8	5851	230.4		975
320/90 R54 151A8/151B TL AGRIBIB RC	272304	96185	434	17.1	1950	76.8	5852	230.4	47	975
IF 800/70 R32 CFO+ 185A8 TL CEREXBIB2	789156	71535	1004	39.5	1950	76.8	5800	228.3		925
VF 380/90 R50 175D TL SPRAYBIB	722276	28608	510	20.1	1951	76.8	5836	229.8	47	975
VF 520/85 R42 CFO+ 177A8 TL CEREXBIB 2	270459	15337	682	26.9	1953	76.9	5807	228.6	47	925
620/70 R42 160D TL OMNIBIB	989457	31015	801	31.5	1953	76.9	5781	227.6	47	925
520/85 R42 162A8/162B TL AGRIBIB 2	405859	13435	694	27.3	1958	77.1	5810	228.7	47	925
620/70 R42 166A8/166B TL MEGAXBIB	100268	15145	801	31.5	1961	77.2	5857	230.6	47	925
IF 680/75 R38 CFO 180A8 TL CEREXBIB	833220	02720	806	31.7	1965	77.4	5823	229.3		975
900/50 R42 168D TL MACHXBIB	832458	3779	1114	43.9	1970	77.6	5826	229.4	47	975
710/70 R38 171D TL MACHXBIB	708197	30751	910	35.8	1973	77.7	5804	228.5	47	925
IF 680/80 R38 CFO+ 182A8 TL CEREXBIB2	953912	20691	845	33.3	2020	79.5	6030	237.4		975
710/70 R42 173D/170E TL ROADBIB	885975	27650	910	35.8	2028	79.8	6025	237.2	48	975
VF 900/60 R38 CFO+ 193A8 TL CEREXBIB 2	439024	31193	1108	43.6	2029	79.9	5993	235.9		975
VF 480/80 R50 166A8/166B TL YELDBIB	309830	2098	614	24.2	2039	80.3	6034	237.6	48	975
VF 580/85 R42 CFO+ 183A8 TL CEREXBIB2	844076	45547	754	29.7	2040	80.3	6040	237.8		975
VF 710/70 R42 179D TL EVOBIB	363574	21253	910	35.8	2042	80.4	6003	236.3		975
VF 480/80 R50 179D TL SPRAYBIB	431251	50045	626	24.6	2045	80.5	6101	240.2	48	975
650/85 R38 173A8/173B TL MEGAXBIB	173491	19212	861	33.9	2048	80.6	6100	240.2	48	975
VF 380/90 R54 176D TL SPRAYBIB	816598	47923	510	20.1	2049	80.7	6131	241.4	48	1025
IF 650/85 R38 179D TL AXIOBIB	084900	97250	845	33.3	2050	80.7	6078	239.3	48	975
480/80 R50 159A8/159B TL AGRIBIB 2	263049	41183	626	24.6	2050	80.7	6116	240.8	48	975
IF 800/70 R38 CFO+ 187A8 TL CEREXBIB2	610997	25474	1004	39.5	2051	80.7	6079	239.3	48	975
VF 420/95 R50 177D TL SPRAYBIB	085405	82545	554	21.8	2052	80.8	6118	240.9	48	1025

ROLLING CIRCUMFERENCE CHART

TYRE SIZE AND RANGE	CAI	MSPN	Minimum Dual Spacing		Tyre Diameter		Rolling Circumference		RCI	SRI
			mm	inches	mm	inches	mm	inches		
380/90 R54 152A8/152B TL AGRIBIB 2	075615	28485	507	20.0	2054	80.9	6129	241.3	48	1025
520/85 R46 164A8/164B TL AGRIBIB 2	120922	17697	658	25.9	2059	81.1	6110	240.6	48	975
620/70 R46 162A8/162B TL XM28	122723	69879	801	31.5	2061	81.1	6122	241.0	48	975
IF 710/70 R42 179D TL AXIOBIB	771752	99783	910	35.8	2062	81.2	6115	240.7	48	975
650/85 R38 173A8/173B TL MACHXBIB	118628	89462	861	33.9	2063	81.2	6092	239.8	48	975
VF 650/85 R38 182D/179E TL AXIOBIB 2	655949		845	33.3	2063	81.2	6078	239.3		975
VF 710/70 R42 182D/179E TL AXIOBIB 2	523668		910	35.8	2066	81.3	6104	240.3		975
800/70 R 38 173D TL MACHXBIB	887730	29390	1008	39.7	2066	81.3	6093	239.9	48	975
IF 800/70 R38 179D TL AXIOBIB	528166	99142	1004	39.5	2067	81.4	6089	239.7	48	975
VF 800/70 R38 187D/184E TL AXIOBIB 2	136377		1004	39.5	2072	81.6	6086	239.6		975
710/70 R42 173D TL MACHXBIB	790388	31962	910	35.8	2088	82.2	6195	243.9	48	975
VF 710/70 R42 CFO+ 188A8 TL CEREXBIB 2	499992	60118	886	34.9	2097	82.6	6207	244.4		975
VF 900/60 R42 CFO+ 195A8 TL CEREXBIB2	856296	03717	1108	43.6	2118	83.4	6281	247.3		1025
IF 900/60 R42 186D TL AXIOBIB	111950	82481	1108	43.6	2123	83.6	6304	248.2	49	1025
VF 710/75 R42 181D TL EVOBIB	149217	78454	910	35.8	2133	84.0	6277	247.1	49	1025
IF 800/70 R42 CFO+ 189A8 TL CEREXBIB2	818789	91180	1004	39.5	2151	84.7	6387	251.5		1025
VF 710/75 R42 184D/180E TL AXIOBIB 2	259635		910	35.8	2153	84.8	6320	248.8	49	1025
710/75 R42 175D/171E TL MACHXBIB	015540		910	35.8	2158	85.0	6424	252.9	49	1025
IF 710/85 R38 178D TL AXIOBIB	992951	99013	918	36.1	2159	85.0	6365	250.6	49	1025
IF 710/75 R42 176D TL AXIOBIB	037489	25479	910	35.8	2161	85.1	6395	251.8	49	1025
VF 650/85 R42 183D/180E TL AXIOBIB 2	530764	06000	845	33.3	2164	85.2	6393	251.7	49	1025
480/95 R50 164A8/164B TL AGRIBIB	491183	54736	638	25.1	2175	85.6	6484	255.3		1075
VF 750/70 R44 186D/183E TL AXIOBIB 2	681569		941	37.0	2180	85.8	6438	253.5		1025
VF 480/95 R50 170A8/170B TL YELDBIB	252129	65206	614	24.2	2186	86.1	6661	262.2	49	1075
IF 750/75 R46 186D TL AXIOBIB	487001	7217	941	37.0	2287	90.0	6819	268.5	50	1125
IF 900/65 R46 190D TL AXIOBIB	162365	36973	1108	43.6	2322	91.4	6888	271.2	50	1125

LOAD INDEX

LOAD INDEX	KG	LBS
100	800	1764
101	825	1819
102	850	1874
103	875	1929
104	900	1984
105	925	2039
106	950	2094
107	975	2150
108	1000	2205
109	1030	2271
110	1060	2337
111	1090	2403
112	1120	2469
113	1150	2535
114	1180	2601
115	1215	2679
116	1250	2756
117	1285	2833
118	1320	2910
119	1360	2998
120	1400	3086
121	1450	3197
122	1500	3307
123	1550	3417
124	1600	3527
125	1650	3638
126	1700	3748
127	1750	3858
128	1800	3968
129	1850	4079
130	1900	4189
131	1950	4299
132	200	441

LOAD INDEX	KG	LBS
133	2060	4542
134	2120	4674
135	2180	4806
136	2240	4938
137	2300	5071
138	2360	5203
139	2430	5357
140	2500	5512
141	2575	5677
142	2650	5842
143	2725	6012
144	2800	6173
145	2900	6393
146	3000	6614
147	3075	6779
148	3150	6945
149	3250	7165
150	3350	7385
151	3450	7606
152	3550	7826
153	3650	8047
154	3750	8267
155	3875	8543
156	4000	8818
157	4125	9094
158	4250	9370
159	4375	9645
160	4500	9921
161	4625	10196
162	4750	10472
163	4875	10748
164	5000	11023
165	5150	11354

LOAD INDEX	KG	LBS
166	5300	11684
167	5450	12015
168	5600	12346
169	5800	12787
173	6000	13228
171	6150	13558
172	6300	13889
173	6500	14330
174	6700	14771
175	6900	15212
176	7100	15653
177	7300	16094
178	7500	16535
179	7750	17086
180	8000	17637
181	8250	18188
182	8500	18739
183	8750	19290
184	9000	19842
185	9250	20393
186	9500	20944
187	9750	21495
188	10000	22046
189	10300	22708
190	10600	23369
191	10900	24030
192	11200	24692
193	11500	25353
194	11800	26015
195	12150	26786
196	12500	27558
197	12850	28329
198	13200	29101

NEW LOAD/PRESSURE

NEW LOAD/PRESSURE TABLES AT 10 AND 30 KM/H FOR MICHELIN ULTRAFLEX TECHNOLOGY (MUT) TRACTOR TYRES

MICHELIN has always been an active promoter of innovation that enables its customers to benefit from the latest technological revolutions!

The remote inflation breakthrough for the agricultural market required changes to the Improved Flexion (IF) and Very high Flexion (VF) standards, something that was achieved in February 2019.



The new load/pressure curves at 10 and 30 km/h for MUT tractor tyres help to adapt tyre pressures to the intended use and context. Combined with a remote inflation system that optimizes these variations in real-time, MICHELIN ULTRAFLEX tyres can now offer their very best performance!

- At low pressure in the field, the soil is protected and productivity is optimal.
- At higher pressures on-road, speed is the objective while controlling fuel consumption and ensuring safety and driving comfort.



THE PROOF IN FIGURES

(Example of a calculation based on MACHXBIB (standard), AXIOBIB (IF) and AXIOBIB 2 (VF) – Size 710/70 R42)

PRESSURE DECREASE POSSIBLE WITH A LOAD OF 5500 KG

(bar)	10 km/h	30 km/h	65 km/h
Standard	1	1.3	1.6
IF	 1	 1.1	 1.2
VF	0.8	0.9	1

LOAD INCREASE POSSIBLE WITH A PRESSURE OF 1.2 BAR

(kg)	10 km/h	30 km/h	65 km/h
Standard	6200	5200	4500
IF	 6200	 5700	 5500
VF	7000	6400	6300

ZEN@TERRA[®]

BEYOND THE TYRE TO PROTECT YOUR SOIL



INCREASED SOIL PROTECTION

- +4% YIELD*

* 4% increase in yield proven by the Harper Adams University study since 2014 for Ultraflex technology



INCREASED PRODUCTIVITY

- +30% TRACTION**

** Internal study on MICHELIN EVOBIB vs MICHELIN AXIOBIB tyres.



INCREASED PROFITABILITY

- FUEL CONSUMPTION
- IMPROVED ON-ROAD SAFETY AND CONTROL

***compared to standard lugged tyres..

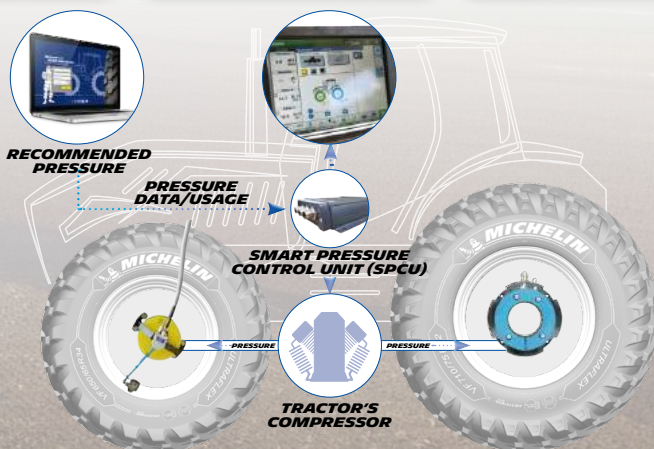

A MICHELIN TECHNOLOGY TYRE

Increase your profits even more by using a Michelin ULTRAFLEX tyre



A PTG REMOTE INFLATION SYSTEM

- that adapts the tyre pressure even while driving



ZEN@TERRA

A MICHELIN solution,
in partnership with



AUTOMATIC PRESSURE CONTROL

- with just 2 clicks on the tractor's Isobus dashboard



MICHELIN SUPPORT

- Setup assistance (via the ZEN@TERRA Agropressure application)
- Help learning to use the system
- Dedicated support hotline



MICHELIN EVOBIB

THE 2 IN 1 ADAPTIVE DESIGN TECHNOLOGY



For High-Powered tractor > 200 HP
Works best with CTIS (Central Tyre Inflation System)



'2 in 1' tyres technology

- adaptive design on the road or in the fields
- **VF** Very High Flexion



Productivity

- Durability
- Fuel savings
- 30% more traction⁽¹⁾



Soil protection

- 20% larger footprint⁽¹⁾
- Low pressure in the fields



Stability at high speed⁽²⁾

- Continuous central rib

(1) Internal study – France Ladoux, MICHELIN EVOBIB VF 710/70R42 vs AXIOBIB IF 710/70R42 at 12 psi

(2) Within the limits stipulated in the laws in force in the country

SIZES

VF 600/70 R30 165D TL

VF 650/65 R34 167D TL

VF 710/70 R42 179D TL

VF 710/75 R42 181D TL

MICHELIN EVOBIB

Tyre specifications and pressure table (bar & psi). Load per tyre in kg*

Ø inches	Description	CAI	S mm	OD mm	LR mm	RC mm	Recommended Rim		Acceptable Rim		Tube (Code)	75% internal volume (litres)	Tread depth (mm)
30	VF 600/70 R30 165D TL	266793	608	1574	668	4616	DW21B (A)		DW20B (A)		737	468	51
Bar	1.8(R)	1.8(R)	1.8(R)	1.8(R)	1.8(R)	1.8(R)	1.8(R)	1.8(R)	1.8(R)	1.8(R)	1.8(R)	2.0(R)	
	0.4(C)	0.5(C)	0.6(C)	0.7(C)	0.8(C)	0.9(C)	1.0(C)	1.1(C)	1.2(C)	1.3(C)	1.4(C)	1.5(C)	1.6(C)
Psi	26(R)	26(R)	26(R)	26(R)	26(R)	26(R)	26(R)	26(R)	26(R)	26(R)	28(R)	29(R)	
	6(C)	7(C)	9(C)	10(C)	12(C)	13(C)	15(C)	16(C)	17(C)	19(C)	20(C)	22(C)	23(C)
10 km/h		3080	3330	3575	3850	4125	4400	4675	4925	5170	5420	5665	
30 km/h		2855	3085	3315	3570	3825	4080	4335	4565	4795	5025	5255	
65 km/h		2800	3025	3250	3500	3750	4000	4250	4475	4700	4925	5150	
65 km/h Dual	2075 2270	2470	2665	2860	3080	3300	3520	3740	3940	4135	4335	4530	

Ø inches	Description	CAI	S mm	OD mm	LR mm	RC mm	Recommended Rim		Acceptable Rim		Tube (Code)	75% internal volume (litres)	Tread depth (mm)
34	VF 650/65 R34 167D TL	262107	638	1707	741	5032	DW23B (A)					555	51
Bar	1.8(R)	1.8(R)	1.8(R)	1.8(R)	1.8(R)	1.8(R)	1.8(R)	1.8(R)	1.8(R)	1.8(R)	1.8(R)	2.0(R)	
	0.4(C)	0.5(C)	0.6(C)	0.7(C)	0.8(C)	0.9(C)	1.0(C)	1.1(C)	1.2(C)	1.3(C)	1.4(C)	1.5(C)	1.6(C)
Psi	26(R)	26(R)	26(R)	26(R)	26(R)	26(R)	26(R)	26(R)	26(R)	26(R)	28(R)	29(R)	
	6(C)	7(C)	9(C)	10(C)	12(C)	13(C)	15(C)	16(C)	17(C)	19(C)	20(C)	22(C)	23(C)
10 km/h		3385	3645	3905	4200	4500	4795	5090	5315	5545	5770	5995	
30 km/h		3135	3380	3620	3895	4170	4445	4720	4930	5140	5350	5560	
65 km/h		3075	3315	3550	3820	4090	4355	4625	4830	5040	5245	5450	
65 km/h Dual	2265 2480	2695	2910	3125	3360	3600	3835	4070	4250	4435	4615	4795	

Ø inches	Description	CAI	S mm	OD mm	LR mm	RC mm	Recommended Rim		Acceptable Rim		Tube (Code)	75% internal volume (litres)	Tread depth (mm)
42	VF 710/70 R42 179D TL	363574	725	2042	875	6003	DW25B (A)		DW23B (A) MW25B (A)		802	867	54
Bar	1.8(R)	1.8(R)	1.8(R)	1.8(R)	1.8(R)	1.8(R)	1.8(R)	1.8(R)	1.8(R)	1.8(R)	1.8(R)	2.0(R)	
	0.4(C)	0.5(C)	0.6(C)	0.7(C)	0.8(C)	0.9(C)	1.0(C)	1.1(C)	1.2(C)	1.3(C)	1.4(C)	1.5(C)	1.6(C)
Psi	26(R)	26(R)	26(R)	26(R)	26(R)	26(R)	26(R)	26(R)	26(R)	26(R)	28(R)	29(R)	
	6(C)	7(C)	9(C)	10(C)	12(C)	13(C)	15(C)	16(C)	17(C)	19(C)	20(C)	22(C)	23(C)
10 km/h		4675	5090	5500	5860	6215	6575	6930	7330	7730	8125	8525	
30 km/h		4335	4720	5100	5430	5765	6095	6425	6795	7165	7535	7905	
65 km/h		4250	4625	5000	5325	5650	5975	6300	6665	7025	7390	7750	
65 km/h Dual	3125 3445	3765	4080	4400	4685	4975	5260	5545	5865	6185	6500	6820	

* Refer to the notes at the end of the tables of this range

MICHELIN EVOBIB

Tyre specifications and pressure table (bar & psi). Load per tyre in kg*

Ø inches	Description	CAI	S min	OD mm	LR mm	RC mm	Recommended Rim		Acceptable Rim		Tube (Code)	75% internal volume (litres)	Tread depth (mm)
42	VF 710/75 R42 181D TL	149217	717	2133	919	6277	DW25B (A)					952	56
Bar	1.8(R) 1.8(R) 1.8(R) 1.8(R) 1.8(R) 1.8(R) 1.8(R) 1.8(R) 1.8(R) 1.8(R) 1.8(R) 2.0(R)	0.4(C) 0.5(C) 0.6(C) 0.7(C) 0.8(C) 0.9(C) 1.0(C) 1.1(C) 1.2(C) 1.3(C) 1.4(C) 1.5(C) 1.6(C)											
Psi	26(R) 26(R) 26(R) 26(R) 26(R) 26(R) 26(R) 26(R) 26(R) 26(R) 26(R) 28(R) 29(R)	6(C) 7(C) 9(C) 10(C) 12(C) 13(C) 15(C) 16(C) 17(C) 19(C) 20(C) 22(C) 23(C)											
10 km/h		4950	5390	5830	6215	6600	6985	7370	7795	8225	8650	9075	
30 km/h		4590	5000	5405	5765	6120	6480	6835	7230	7625	8020	8415	
65 km/h		4500	4900	5300	5650	6000	6350	6700	7090	7475	7865	8250	
65 km/h Dual	3300 3640	3985	4325	4665	4975	5280	5590	5895	6235	6580	6920	7260	

***IMPORTANT:**

The inflation pressure must always be appropriate for the load per tyre, the speed of travel and the work to be done. Our recommendations above were correct as of the time of publication of these tables (June 2018). Technical data is subject to change without prior notice.

- When using single tyre configuration:
 - add 0.4 bar for use on slopes of more than 20%
 - add 0.4 bar for intense road use exceeding 50%
- (R) Road Pressure
- (C) Field Pressure

**NEW**

MICHELIN ROADBIB

**THE SOLUTION
FOR HEAVY ROAD USE
(> 80% OF HOURS ON
THE ROAD)**



FUEL SAVINGS

- A wide footprint combined with an optimised tread depth provides low rolling resistance and thus reduced fuel consumption.



LONG LIFE

- Extraordinary performance in terms of longevity: +20% more rubber to the ground vs. MachXBib
- Exclusive design: new tread pattern
- Directional tyres



GREAT COMFORT

- Smooth central rib improves comfort on roads
- Reduced space between tread blocks (compared to traditional sculptures) limits cabin vibrations
- Quiet running tyre



HANDLING & SAFETY

- Improved ride quality thanks to a new sculpture similar to that of a truck tyre
- Good tyre adhesion on wet roads thanks to vertical evacuation paths

SIZES

600/70 R30 158D/155E TL

710/70 R42 173D/170E TL

MICHELIN ROADBIB

Tyre specifications and pressure table (bar & psi). Load per tyre in kg*

Ø inches	Description	CAI	S mm	OD mm	LR mm	RC mm	Recommended Rim		Acceptable Rim		Tube (Code)	75% internal volume (litres)	Tread depth (mm)
30	600/70 R30 158D/155E TL	217911	610	1569	684	4630	DW20B (A)		DW18L DW21B (A)		802	468	40
Bar	0.4 0.6 0.8	1.0 1.2	1.4 1.6	1.8 2.0	2.2 2.4	2.6 2.8							
Psi	6 9 12	15 17	20 23	26 29	32 35	38 41							
10 km/h	2475 2830 3185	3540 3955	4375 4790	5210 5625	5815 6000	6190 6375							
30 km/h	1900 2285 2665	3050 3435	3815 4200	4375 4545	4720 4890								
40 km/h	2190 2550 2910	3275 3635	3995 4160	4325 4490	4655								
50 km/h	2100 2445 2795	3140 3490	3835 3995	4150 4310	4465								
65 km/h	2360 2685 3005	3325 3650	3800 3950	4100 4250									
70 km/h	2150 2445 2735	3030 3320	3460 3600	3735 3875									

Ø inches	Description	CAI	S mm	OD mm	LR mm	RC mm	Recommended Rim		Acceptable Rim		Tube (Code)	75% internal volume (litres)	Tread depth (mm)
42	710/70 R42 173D/170E TL	885975	710	2028	915	6025	DW23B (A)		DW25B (A)		802	867	38
Bar	0.4 0.6 0.8	1.0 1.2	1.4 1.6	1.8 2.0	2.2 2.4	2.6 2.8							
Psi	6 9 12	15 17	20 23	26 29	32 35	38 41							
10 km/h	3750 4275 4800	5325 6000	6675 7350	8025 8700	8965 9225	9490 9750							
30 km/h	2875 3470 4065	4660 5250	5845 6440	6700 6960	7215 7475								
40 km/h	3285 3855 4425	4990 5560	6130 6380	6625 6875	7120								
50 km/h	3150 3695 4240	4790 5335	5880 6115	6355 6590	6825								
65 km/h	3550 4065 4575	5090 5600	5825 6050	6275 6500									
70 km/h	3230 3695 4165	4630 5095	5320 5550	5775 6000									

***IMPORTANT:**

The inflation pressure must always be appropriate for the load per tyre, the speed of travel and the work to be done. Our recommendations above were correct as of the time of publication of these tables (June 2018). Technical data is subject to change without prior notice.

- For ploughing and other field applications subject to high torque, use the 30 km/h column.
 - When using single tyre configuration:
 - add 0.4 bar for use on slopes of more than 20%
 - add 0.4 bar for intense road use exceeding 50%
- **10 km/h LT (Low Torque) (max speed 10 km/h).



MICHELIN AXIOBIB 2

**HIGH TRACTION CAPACITY
FOR HEAVY LOADS**



For tractors from **160 to 550 HP**



VF Very High Flexion



Soil protection thanks to low pressure,

- Carry up to 40% more load at the same pressure versus non-VF radial tyre in the same size



More **traction** ⁽¹⁾



Better **productivity** from **+7% to +11%** ⁽¹⁾

Potential increase in yields of up to 4% year ⁽²⁾

(1) Internal test 2016, depending on the size. Comparing MICHELIN AXIOBIB 2 VF 650/85 R42 vs MICHELIN MACHXBIB 650/85 R38
(2) Harper Adams University 2014/2016

SIZES

VF 540/65 R30 158D/155E TL

VF 600/60 R30 162D/159E TL

VF 600/70 R30 168D/165E TL

VF 620/75 R30 172D/169E TL

VF 650/60 R34 168D/165E TL **NEW**

VF 650/65 R34 170D/167E TL **NEW**

VF 650/60 R38 170D/167E TL **NEW**

VF 650/85 R38 182D/179E TL **NEW**

VF 800/70 R38 187D/184E TL **NEW**

VF 710/60 R42 176D/173E TL

VF 650/65 R42 174D/171E TL

VF 710/70 R42 182D/179E TL **NEW**

VF 710/75 R42 184D/180E TL **NEW**

VF 650/85 R42 183D/180E TL

VF 750/70 R44 186D/183E TL

MICHELIN AXIOBIB 2

Tyre specifications and pressure table (bar & psi). Load per tyre in kg*

Ø inches	Description	CAI	S mm	OD mm	LR mm	RC mm	Recommended Rim		Acceptable Rim		Tube (Code)	75% internal volume (litres)	Tread depth (mm)		
30	VF 540/65 R30 158D/155E TL	296638	536	1460	641	4316	W18L		W16L (NRO)		754	332	48		
Bar	0.4	0.6	0.8	0.9	1.0	1.1	1.2	1.3	1.4	1.5	1.6	1.7	1.8	1.9	2.0
Psi	6	9	12	13	15	16	17	19	20	22	23	25	26	28	29
10 km/h	2400	2750	2940	3130	3320	3510	3695	3885	4075	4265	4370	4470	4575	4675	
30 km/h	2225	2550	2725	2900	3075	3255	3430	3605	3780	3955	4050	4145	4240	4335	
65 km/h	2180	2500	2670	2845	3015	3190	3360	3530	3705	3875	3970	4065	4155	4250	
70 km/h	2000	2330	2495	2655	2820	2985	3130	3270	3415	3555	3640	3730	3815	3900	
65 km/h Dual	1920	2180	2310	2440	2570	2700	2830	2960	3090	3220	3350	3480	3610	3740	

Ø inches	Description	CAI	S mm	OD mm	LR mm	RC mm	Recommended Rim		Acceptable Rim		Tube (Code)	75% internal volume (litres)	Tread depth (mm)		
30	VF 600/60 R30 162D/159E TL	371968	597	1468	643	4336	DW20B (A)		DW18L (NRO)		757	381	49		
Bar	0.4	0.6	0.8	0.9	1.0	1.1	1.2	1.3	1.4	1.5	1.6	1.7	1.8	1.9	2.0
Psi	6	9	12	13	15	16	17	19	20	22	23	25	26	28	29
10 km/h	2530	2965	3180	3395	3605	3820	4035	4250	4460	4675	4815	4950	5090	5225	
30 km/h	2345	2750	2950	3145	3345	3545	3740	3940	4135	4335	4465	4590	4720	4845	
65 km/h	2300	2695	2890	3085	3280	3475	3665	3860	4055	4250	4375	4500	4625	4750	
70 km/h	2095	2445	2620	2790	2965	3140	3325	3505	3690	3870	3985	4100	4210	4325	
65 km/h Dual	1715	2055	2390	2550	2715	2875	3035	3210	3390	3565	3740	3850	3960	4070	4180

Ø inches	Description	CAI	S mm	OD mm	LR mm	RC mm	Recommended Rim		Acceptable Rim		Tube (Code)	75% internal volume (litres)	Tread depth (mm)		
30	VF 600/70 R30 168D/165E TL	426719	624	1579	689	4659	DW21B (A)		DW20B (A)		737	468	58		
Bar	0.4	0.6	0.8	0.9	1.0	1.1	1.2	1.3	1.4	1.5	1.6	1.7	1.8	1.9	2.0
Psi	6	9	12	13	15	16	17	19	20	22	23	25	26	28	29
10 km/h	3080	3575	3835	4100	4360	4620	4880	5145	5405	5665	5790	5915	6035	6160	
30 km/h	2855	3315	3560	3800	4045	4285	4530	4770	5015	5255	5370	5485	5595	5710	
65 km/h	2800	3250	3490	3725	3965	4200	4440	4675	4915	5150	5265	5375	5490	5600	
70 km/h	2550	2990	3210	3430	3650	3870	4075	4280	4480	4685	4790	4890	4995	5095	
65 km/h Dual	2075	2470	2860	3080	3300	3520	3740	3940	4135	4335	4530	4630	4730	4830	4930

* Refer to the notes at the end of the tables of this range

MICHELIN AXIOBIB 2

Tyre specifications and pressure table (bar & psi). Load per tyre in kg*

Ø inches	Description	CAI	S mm	OD mm	LR mm	RC mm	Recommended Rim		Acceptable Rim		Tube (Code)	75% internal volume (litres)	Tread depth (mm)		
30	VF 620/75 R30 172D/169E TL	702894	662	1670	722	4919	DW23B (A)		DW20B (A) DW21B (A)		737	556	58		
Bar	0.4	0.6	0.8	0.9	1.0	1.1	1.2	1.3	1.4	1.5	1.6	1.7	1.8	1.9	2.0
Psi	6	9	12	13	15	16	17	19	20	22	23	25	26	28	29
10 km/h	3465	4015	4310	4605	4900	5200	5495	5790	6085	6380	6520	6655	6795	6930	
30 km/h	3215	3725	4000	4275	4545	4820	5095	5370	5640	5915	6045	6170	6300	6425	
65 km/h	3150	3650	3920	4190	4455	4725	4995	5265	5530	5800	5925	6050	6175	6300	
70 km/h	2890	3380	3625	3870	4115	4360	4600	4845	5085	5325	5440	5555	5670	5785	
65 km/h Dual	2770	3165	3365	3565	3760	3960	4160	4355	4555	4750	4950	5150	5345	5545	

Ø inches	Description	CAI	S mm	OD mm	LR mm	RC mm	Recommended Rim		Acceptable Rim		Tube (Code)	75% internal volume (litres)	Tread depth (mm)		
34	VF 650/60 R34 168D/165E TL NEW	202185	672	1661	735	4918	DW23B (A)		DW21B (A) DW24B (A)		823	500	58		
Bar	0.4	0.6	0.8	0.9	1.0	1.1	1.2	1.3	1.4	1.5	1.6	1.7	1.8	1.9	2.0
Psi	6	9	12	13	15	16	17	19	20	22	23	25	26	28	29
10 km/h	3080	3565	3830	4090	4355	4615	4880	5140	5405	5665	5790	5915	6035	6160	
30 km/h	2855	3305	3550	3795	4035	4280	4525	4770	5010	5255	5370	5485	5595	5710	
65 km/h	2800	3240	3480	3720	3955	4195	4435	4675	4910	5150	5265	5375	5490	5600	
70 km/h	2580	2985	3190	3395	3595	3800	4035	4275	4510	4745	4850	4955	5055	5160	
65 km/h Dual	2025	2445	2860	3055	3245	3440	3630	3855	4080	4305	4530	4630	4730	4830	4930

Ø inches	Description	CAI	S mm	OD mm	LR mm	RC mm	Recommended Rim		Acceptable Rim		Tube (Code)	75% internal volume (litres)	Tread depth (mm)		
34	VF 650/65 R34 170D/167E TL NEW	101906	679	1710	756	5061	DW23B (A)				823	600	58		
Bar	0.4	0.6	0.8	0.9	1.0	1.1	1.2	1.3	1.4	1.5	1.6	1.7	1.8	1.9	2.0
Psi	6	9	12	13	15	16	17	19	20	22	23	25	26	28	29
10 km/h	3385	3950	4205	4460	4715	4975	5230	5485	5740	5995	6145	6300	6450	6600	
30 km/h	3135	3660	3900	4135	4375	4610	4850	5085	5325	5560	5700	5840	5980	6120	
65 km/h	3075	3590	3825	4055	4290	4520	4755	4985	5220	5450	5590	5725	5865	6000	
70 km/h	2830	3305	3545	3785	4020	4260	4450	4640	4830	5020	5145	5275	5400	5525	
65 km/h Dual	2265	2695	3125	3360	3600	3835	4070	4250	4435	4615	4795	4915	5040	5160	5280

* Refer to the notes at the end of the tables of this range

MICHELIN AXIOBIB 2

Tyre specifications and pressure table (bar & psi). Load per tyre in kg*

Ø inches	Description	CAI	S mm	OD mm	LR mm	RC mm	Recommended Rim		Acceptable Rim	Tube (Code)	75% internal volume (litres)	Tread depth (mm)			
38	VF 650/60 R38 170D/167E TL NEW	908973	668	1742	772	5145	1.3	1.4	DW23B (A) DW20B(A) (NRO) MW23B(A)	825	540	58			
Bar	0.4	0.6	0.8	0.9	1.0	1.1	1.2	1.3	1.4	1.5	1.6	1.7	1.8	1.9	2.0
Psi	6	9	12	13	15	16	17	19	20	22	23	25	26	28	29
10 km/h	3190	3795	4050	4305	4560	4815	5065	5320	5575	5830	6025	6215	6410	6600	
30 km/h	2960	3520	3755	3990	4225	4465	4700	4935	5170	5405	5585	5765	5940	6120	
65 km/h	2900	3450	3680	3915	4145	4375	4605	4840	5070	5300	5475	5650	5825	6000	
70 km/h	2640	3085	3310	3535	3755	3980	4190	4405	4615	4825	4985	5145	5300	5460	
65 km/h Dual	2140	2590	3035	3240	3445	3645	3850	4055	4260	4460	4665	4820	4975	5125	5280

Ø inches	Description	CAI	S mm	OD mm	LR mm	RC mm	Recommended Rim		Acceptable Rim	Tube (Code)	75% internal volume (litres)	Tread depth (mm)			
38	VF 650/85 R38 182D/179E TL NEW	655949	680	2063	913	6078	1.3	1.4	DW23B (A) DW20B (A) DW21B	804	857	63			
Bar	0.4	0.6	0.8	0.9	1.0	1.1	1.2	1.3	1.4	1.5	1.6	1.7	1.8	1.9	2.0
Psi	6	9	12	13	15	16	17	19	20	22	23	25	26	28	29
10 km/h	4675	5365	5760	6155	6550	6945	7340	7735	8130	8525	8730	8940	9145	9350	
30 km/h	4335	4975	5340	5710	6075	6440	6805	7175	7540	7905	8095	8290	8480	8670	
65 km/h	4250	4875	5235	5595	5955	6315	6670	7030	7390	7750	7940	8125	8315	8500	
70 km/h	3870	4490	4805	5115	5425	5735	6065	6395	6725	7055	7230	7405	7575	7750	
65 km/h Dual	3125	3710	4290	4605	4920	5230	5545	5865	6185	6500	6820	6985	7150	7315	7480

Ø inches	Description	CAI	S mm	OD mm	LR mm	RC mm	Recommended Rim		Acceptable Rim	Tube (Code)	75% internal volume (litres)	Tread depth (mm)			
38	VF 800/70 R38 187D/184E TL NEW	136377	821	2072	883	6086	1.3	1.4	DW27B (A) DW25B (A)	804	1,073,25	63			
Bar	0.4	0.6	0.8	0.9	1.0	1.1	1.2	1.3	1.4	1.5	1.6	1.7	1.8	1.9	2.0
Psi	6	9	12	13	15	16	17	19	20	22	23	25	26	28	29
10 km/h	5365	6380	6820	7260	7700	8140	8580	9020	9460	9900	10105	10315	10520	10725	
30 km/h	4975	5915	6325	6730	7140	7550	7955	8365	8770	9180	9370	9565	9755	9945	
65 km/h	4875	5800	6200	6600	7000	7400	7800	8200	8600	9000	9190	9375	9565	9750	
70 km/h	4435	5170	5540	5910	6275	6645	7030	7420	7805	8190	8360	8535	8705	8875	
65 km/h Dual	3630	4370	5105	5435	5765	6095	6425	6800	7175	7545	7920	8085	8250	8415	8580

* Refer to the notes at the end of the tables of this range

MICHELIN AXIOBIB 2

Tyre specifications and pressure table (bar & psi). Load per tyre in kg*

Ø inches	Description	CAI	S mm	OD mm	LR mm	RC mm	Recommended Rim		Acceptable Rim		Tube (Code)	75% internal volume (litres)	Tread depth (mm)		
42	VF 710/60 R42 176D/173E TL	941770	730	1885	830	5574	DW25B (A)		DW23B (A) (NRO) MW25B (A)		802	710	58		
Bar	0.4	0.6	0.8	0.9	1.0	1.1	1.2	1.3	1.4	1.5	1.6	1.7	1.8	1.9	2.0
Psi	6	9	12	13	15	16	17	19	20	22	23	25	26	28	29
10 km/h	3795	4540	4865	5195	5520	5845	6170	6495	6825	7150	7315	7480	7645	7810	
30 km/h	3520	4210	4515	4815	5120	5420	5725	6025	6330	6630	6785	6935	7090	7240	
65 km/h	3450	4125	4420	4720	5015	5315	5610	5905	6205	6500	6650	6800	6950	7100	
70 km/h	3140	3700	3985	4265	4545	4825	5100	5370	5645	5915	6050	6190	6325	6460	
65 km/h Dual	2550	3090	3630	3890	4150	4405	4665	4930	5195	5455	5720	5855	6120	6250	

Ø inches	Description	CAI	S mm	OD mm	LR mm	RC mm	Recommended Rim		Acceptable Rim		Tube (Code)	75% internal volume (litres)	Tread depth (mm)		
42	VF 650/65 R42 174D/171E TL	387916	666	1920	847	5680	DW23B (A)		DW20B (A) (NRO) DW21B(A)		802	643	58		
Bar	0.4	0.6	0.8	0.9	1.0	1.1	1.2	1.3	1.4	1.5	1.6	1.7	1.8	1.9	2.0
Psi	6	9	12	13	15	16	17	19	20	22	23	25	26	28	29
10 km/h	3685	4400	4675	4950	5225	5500	5775	6050	6325	6600	6795	6985	7180	7370	
30 km/h	3415	4080	4335	4590	4845	5100	5355	5610	5865	6120	6300	6480	6655	6835	
65 km/h	3350	4000	4250	4500	4750	5000	5250	5500	5750	6000	6175	6350	6525	6700	
70 km/h	3075	3580	3835	4085	4340	4590	4820	5050	5275	5505	5665	5830	5990	6150	
65 km/h Dual	2465	2995	3520	3740	3960	4180	4400	4620	4840	5060	5280	5435	5590	5740	5895

Ø inches	Description	CAI	S mm	OD mm	LR mm	RC mm	Recommended Rim		Acceptable Rim		Tube (Code)	75% internal volume (litres)	Tread depth (mm)		
42	VF 710/70 R42 182D/179E TL NEW	523668	731	2066	906	6104	DW25B (A)		DW23B (A) MW25B (A)		802	867	63		
Bar	0.4	0.6	0.8	0.9	1.0	1.1	1.2	1.3	1.4	1.5	1.6	1.7	1.8	1.9	2.0
Psi	6	9	12	13	15	16	17	19	20	22	23	25	26	28	29
10 km/h	4675	5500	5880	6255	6635	7015	7390	7770	8145	8525	8730	8940	9145	9350	
30 km/h	4335	5100	5450	5800	6150	6505	6855	7205	7555	7905	8095	8290	8480	8670	
65 km/h	4250	5000	5345	5690	6030	6375	6720	7065	7405	7750	7940	8125	8315	8500	
70 km/h	3870	4490	4805	5115	5425	5735	6065	6395	6725	7055	7230	7405	7575	7750	
65 km/h Dual	3125	3765	4400	4685	4975	5260	5545	5865	6185	6500	6820	6985	7150	7315	7480

* Refer to the notes at the end of the tables of this range

MICHELIN AXIOBIB 2

Tyre specifications and pressure table (bar & psi). Load per tyre in kg*

Ø inches	Description	CAI	S mm	OD mm	LR mm	RC mm	Recommended Rim	Acceptable Rim	Tube (Code)	75% internal volume (litres)	Tread depth (mm)				
42	VF 710/75 R42 184D/180E TL NEW	259635	737	2153	916	6320	DW25B (A)		802	945	65				
Bar	0.4	0.6	0.8	0.9	1.0	1.1	1.2	1.3	1.4	1.5	1.6	1.7	1.8	1.9	2.0
Psi	6	9	12	13	15	16	17	19	20	22	23	25	26	28	29
10 km/h	4950	5760	6175	6590	7005	7420	7830	8245	8660	9075	9280	9490	9695	9900	
30 km/h	4590	5340	5725	6110	6495	6880	7260	7645	8030	8415	8605	8800	8990	9180	
65 km/h	4500	5235	5610	5990	6365	6745	7120	7495	7875	8250	8440	8625	8815	9000	
70 km/h	4145	4820	5160	5495	5835	6170	6530	6885	7245	7600	7700	7800	7900	8000	
65 km/h Dual	3300	3985	4665	4975	5280	5590	5895	6235	6580	6920	7260	7425	7590	7755	7920

Ø inches	Description	CAI	S mm	OD mm	LR mm	RC mm	Recommended Rim	Acceptable Rim	Tube (Code)	75% internal volume (litres)	Tread depth (mm)				
42	VF 650/85 R42 183D/180E TL	530764	670	2164	948	6393	DW23B (A)	DW21B(A)	802	914	61				
Bar	0.4	0.6	0.8	0.9	1.0	1.1	1.2	1.3	1.4	1.5	1.6	1.7	1.8	1.9	2.0
Psi	6	9	12	13	15	16	17	19	20	22	23	25	26	28	29
10 km/h	4815	5665	6055	6450	6840	7235	7625	8015	8410	8800	9005	9215	9420	9625	
30 km/h	4465	5255	5620	5980	6345	6710	7070	7435	7795	8160	8350	8545	8735	8925	
65 km/h	4375	5150	5505	5865	6220	6575	6930	7290	7645	8000	8190	8375	8565	8750	
70 km/h	4015	4665	4990	5315	5640	5965	6310	6655	7000	7345	7515	7690	7860	8030	
65 km/h Dual	3850	4400	4675	4950	5225	5500	5775	6050	6325	6600	6875	7150	7425	7700	

Ø inches	Description	CAI	S mm	OD mm	LR mm	RC mm	Recommended Rim	Acceptable Rim	Tube (Code)	75% internal volume (litres)	Tread depth (mm)				
44	VF 750/70 R44 186D/183E TL	681569	763	2180	956	6438	DW25B (A)	MW24B(A) MW25B(A) DW24B(A)		1,016	64				
Bar	0.4	0.6	0.8	0.9	1.0	1.1	1.2	1.3	1.4	1.5	1.6	1.7	1.8	1.9	2.0
Psi	6	9	12	13	15	16	17	19	20	22	23	25	26	28	29
10 km/h	5225	6090	6530	6975	7415	7860	8300	8740	9185	9625	9830	10040	10245	10450	
30 km/h	4845	5645	6055	6465	6875	7285	7695	8105	8515	8925	9115	9310	9500	9690	
65 km/h	4750	5535	5935	6340	6740	7145	7545	7945	8350	8750	8940	9125	9315	9500	
70 km/h	4375	5095	5460	5820	6180	6540	6920	7300	7680	8060	8235	8405	8580	8750	
65 km/h Dual	3410	4105	4795	5160	5525	5885	6250	6615	6975	7340	7700	7865	8030	8195	8360

***IMPORTANT:**

The inflation pressure must always be appropriate for the load per tyre, the speed of travel and the work to be done. Our recommendations above were correct as of the time of publication of these tables (June 2018). Technical data is subject to change without prior notice.

- When using single tyre configuration:
 - add 0.4 bar for use on slopes of more than 20%
 - add 0.4 bar for intense road use exceeding 50%
- (NRO) - Narrow rim option - when using NRO add 0.2 bar.



MICHELIN AXIOBIB

IMPROVED TRACTION & SOIL PROTECTION FOR VERY HIGH-POWERED TRACTORS



For High-Powered tractors **250 HP and over**



Improved Flexion Standard (IF)

Carry up to 20% more load at the same pressure versus non-IF radial tyre in the same size



Better Yields +4% /Year⁽¹⁾



Fuel Savings up to **15%** when working in the field⁽²⁾



+11% traction with AXIOBIB IF 710/70R42 vs standard 710/70R42



Soil Protection thanks to low pressure capability

(1) Harper Adams University 2014/2016

(2) On average, observed versus standard equipment during field demonstrations.

SIZES

IF 600/70 R30 159D TL

IF 620/75 R30 164D TL

IF 650/75 R30 166D TL

IF 650/60 R34 165D TL

IF 710/60 R34 164D TL

IF 650/65 R34 161D TL

IF 650/65 R38 169D TL

IF 710/60 R38 172D TL

IF 650/85 R38 179D TL

IF 800/70 R38 179D TL

IF 710/85 R38 178D TL

IF 710/70 R42 179D TL

IF 900/60 R42 186D TL

IF 710/75 R42 176D TL

IF 750/75 R46 186D TL

IF 900/65 R46 190D TL

MICHELIN AXIOBIB

Tyre specifications and pressure table (bar & psi). Load per tyre in kg*

Ø inches	Description	CAI	S mm	OD mm	LR mm	RC mm	Recommended Rim		Acceptable Rim		Tube (Code)	75% internal volume (litres)			Tread depth (mm)
30	IF 600/70 R30 159D TL	280086	613	1585	695	4683	DW21B (A)		DW20B (A)		737	450			56
Bar	0.4	0.6	0.8	1.0	1.2	1.4	1.6	1.7	1.8	1.9	2.0	2.1	2.2	2.3	2.4
Psi	6	9	12	15	17	20	23	25	26	28	29	30	32	33	35
10 km/h		3220	3710	4200	4615	5030									
30 km/h		2910	3355	3795	4175	4550									
65 km/h		2800	3225	3650	4015	4375									
65 km/h Dual	1760 2110	2460	2835	3210	3530	3850									

Ø inches	Description	CAI	S mm	OD mm	LR mm	RC mm	Recommended Rim		Acceptable Rim		Tube (Code)	75% internal volume (litres)			Tread depth (mm)
30	IF 600/75 R30 164D TL	668406	659	1670	728	4927	DW23B (A)		DW21B (A) MW23B(A)		737	570			58
Bar	0.4	0.6	0.8	1.0	1.2	1.4	1.6	1.7	1.8	1.9	2.0	2.1	2.2	2.3	2.4
Psi	6	9	12	15	17	20	23	25	26	28	29	30	32	33	35
10 km/h		3620	4110	4600	5175	5750									
30 km/h		3275	3720	4160	4680	5200									
65 km/h		3150	3575	4000	4500	5000									
65 km/h Dual	1970 2370	2770	3145	3520	3960	4400									

Ø inches	Description	CAI	S mm	OD mm	LR mm	RC mm	Recommended Rim		Acceptable Rim		Tube (Code)	75% internal volume (litres)			Tread depth (mm)
30	IF 650/75 R30 166D TL	828322	679	1721	745	5071	DW23B (A)		MW23B(A)			638			57
Bar	0.4	0.6	0.8	1.0	1.2	1.4	1.6	1.7	1.8	1.9	2.0	2.1	2.2	2.3	2.4
Psi	6	9	12	15	17	20	23	25	26	28	29	30	32	33	35
10 km/h		3965	4500	5030	5565	6095									
30 km/h		3590	4070	4550	5030	5510									
65 km/h		3450	3915	4375	4840	5300									
65 km/h Dual	2140 2590	3040	3445	3850	4255	4660									

Ø inches	Description	CAI	S mm	OD mm	LR mm	RC mm	Recommended Rim		Acceptable Rim		Tube (Code)	75% internal volume (litres)			Tread depth (mm)
34	IF 650/60 R34 165D TL	100511	633	1661	745	4933	DW23B (A)		DW21B (A) DW24B (A)		823	500			58
Bar	0.4	0.6	0.8	1.0	1.2	1.4	1.6	1.7	1.8	1.9	2.0	2.1	2.2	2.3	2.4
Psi	6	9	12	15	17	20	23	25	26	28	29	30	32	33	35
10 km/h		3220	3675	4130	4580	5030	5145	5255	5370	5480	5590	5700	5810	5920	
30 km/h		2910	3325	3735	4145	4550	4650	4755	4855	4955	5055	5155	5255	5355	
65 km/h		2800	3195	3590	3985	4375	4475	4570	4670	4765	4860	4960	5055	5150	
65 km/h Dual	1760 2115	2465	2815	3160	3505	3850	3935	4020	4105	4190	4275	4360	4445	4530	

* Refer to the notes at the end of the tables of this range

MICHELIN AXIOBIB

Tyre specifications and pressure table (bar & psi). Load per tyre in kg*

Ø inches	Description	CAI	S mm	OD mm	LR mm	RC mm	Recommended Rim		Acceptable Rim		Tube (Code)	75% internal volume (litres)		Tread depth (mm)	
34	IF 710/60 R34 164D TL	712503	708	1696	756	5030	DW25B (A)					615		58	
Bar	0.4	0.6	0.8	1.0	1.2	1.4	1.6	1.7	1.8	1.9	2.0	2.1	2.2	2.3	2.4
Psi	6	9	12	15	17	20	23	25	26	28	29	30	32	33	35
10 km/h			3620	4185	4745	5250	5750								
30 km/h			3275	3785	4290	4745	5200								
65 km/h			3150	3640	4125	4565	5000								
65 km/h Dual	1970	2370	2770	3200	3630	4015	4400								

Ø inches	Description	CAI	S mm	OD mm	LR mm	RC mm	Recommended Rim		Acceptable Rim		Tube (Code)	75% internal volume (litres)		Tread depth (mm)	
34	IF 650/65 R34 161D TL	711975	653	1721	764	5099	DW23B (A)				823	555		58	
Bar	0.4	0.6	0.8	1.0	1.2	1.4	1.6	1.7	1.8	1.9	2.0	2.1	2.2	2.3	2.4
Psi	6	9	12	15	17	20	23	25	26	28	29	30	32	33	35
10 km/h			3535	4070	4600	4960	5320								
30 km/h			3200	3680	4160	4485	4810								
65 km/h			3075	3540	4000	4315	4625								
65 km/h Dual	1920	2315	2710	3115	3520	3795	4070								

Ø inches	Description	CAI	S mm	OD mm	LR mm	RC mm	Recommended Rim		Acceptable Rim		Tube (Code)	75% internal volume (litres)		Tread depth (mm)	
38	IF 650/65 R38 169D TL	508421	649	1826	833	5446	DW23B (A)		MN21B(A)		825	599		58	
Bar	0.4	0.6	0.8	1.0	1.2	1.4	1.6	1.7	1.8	1.9	2.0	2.1	2.2	2.3	2.4
Psi	6	9	12	15	17	20	23	25	26	28	29	30	32	33	35
10 km/h			3735	4240	4745	5175	5605	5740	5875	6005	6140	6275	6405	6540	6670
30 km/h			3380	3835	4290	4680	5070	5190	5315	5435	5555	5675	5795	5910	6030
65 km/h			3250	3690	4125	4500	4875	4990	5110	5225	5340	5455	5570	5685	5800
65 km/h Dual	2025	2445	2860	3245	3630	3960	4290	4390	4495	4595	4695	4795	4900	5000	5100

Ø inches	Description	CAI	S mm	OD mm	LR mm	RC mm	Recommended Rim		Acceptable Rim		Tube (Code)	75% internal volume (litres)		Tread depth (mm)	
38	IF 710/60 R38 172D TL	220975	710	1844	834	5486	DW25B (A)				825	661		58	
Bar	0.4	0.6	0.8	1.0	1.2	1.4	1.6	1.7	1.8	1.9	2.0	2.1	2.2	2.3	2.4
Psi	6	9	12	15	17	20	23	25	26	28	29	30	32	33	35
10 km/h			3850	4415	4975	5535	6095	6240	6385	6525	6670	6815	6960	7100	7245
30 km/h			3485	3995	4500	5005	5510	5640	5770	5900	6030	6160	6290	6420	6550
65 km/h			3350	3840	4325	4815	5300	5425	5550	5675	5800	5925	6050	6175	6300
65 km/h Dual	2360	2680	3000	3410	3815	4220	4625	4740	4855	4970	5085	5200	5315	5430	5545

* Refer to the notes at the end of the tables of this range

MICHELIN AXIOBIB

Tyre specifications and pressure table (bar & psi). Load per tyre in kg*

Ø inches	Description	CAI	S mm	OD mm	LR mm	RC mm	Recommended Rim		Acceptable Rim		Tube (Code)	75% internal volume (litres)	Tread depth (mm)		
38	IF 650/85 R38 179D TL	084900	692	2050	913	6078	DW23B (A)		MW23B (A)		804	900	63		
Bar	0.4	0.6	0.8	1.0	1.2	1.4	1.6	1.7	1.8	1.9	2.0	2.1	2.2	2.3	2.4
Psi	6	9	12	15	17	20	23	25	26	28	29	30	32	33	35
10 km/h			4890	5580	6265	6985	7705	7880	8050	8225	8395	8525	8655	8785	8915
30 km/h			4420	5045	5670	6320	6970	7125	7280	7435	7590	7710	7825	7945	8060
65 km/h			4250	4850	5450	6075	6700	6850	7000	7150	7300	7415	7525	7640	7750
65 km/h Dual	2640	3190	3740	4270	4800	5350	5900	6030	6160	6290	6420	6520	6620	6720	6820

Ø inches	Description	CAI	S mm	OD mm	LR mm	RC mm	Recommended Rim		Acceptable Rim		Tube (Code)	75% internal volume (litres)	Tread depth (mm)		
38	IF 800/70 R38 179D TL	528166	810	2067	894	6089	DW27B (A)				804	1,088	63		
Bar	0.4	0.6	0.8	1.0	1.2	1.4	1.6	1.7	1.8	1.9	2.0	2.1	2.2	2.3	2.4
Psi	6	9	12	15	17	20	23	25	26	28	29	30	32	33	35
10 km/h			5605	6425	7245	8080	8915								
30 km/h			5070	5810	6550	7305	8060								
65 km/h			4875	5590	6300	7025	7750								
65 km/h Dual	3040	3665	4290	4915	5540	6180	6820								

Ø inches	Description	CAI	S mm	OD mm	LR mm	RC mm	Recommended Rim		Acceptable Rim		Tube (Code)	75% internal volume (litres)	Tread depth (mm)		
38	IF 710/85 R38 178D TL	992951	734	2159	937	6365	DW25B (A)		MW25B (A)		804	1,088	65		
Bar	0.4	0.6	0.8	1.0	1.2	1.4	1.6	1.7	1.8	1.9	2.0	2.1	2.2	2.3	2.4
Psi	6	9	12	15	17	20	23	25	26	28	29	30	32	33	35
10 km/h			5605	6340	7070	7850	8625								
30 km/h			5070	5735	6395	7100	7800								
65 km/h			4875	5515	6150	6825	7500								
65 km/h Dual	3040	3665	4290	4850	5410	6005	6600								

Ø inches	Description	CAI	S mm	OD mm	LR mm	RC mm	Recommended Rim		Acceptable Rim		Tube (Code)	75% internal volume (litres)	Tread depth (mm)		
42	IF 710/70 R42 179D TL	771752	742	2062	919	6115	DW25B (A)		DW23B MW25B (A)		802	870	63		
Bar	0.4	0.6	0.8	1.0	1.2	1.4	1.6	1.7	1.8	1.9	2.0	2.1	2.2	2.3	2.4
Psi	6	9	12	15	17	20	23	25	26	28	29	30	32	33	35
10 km/h			4890	5580	6265	6985	7705	7880	8050	8225	8395	8525	8655	8785	8915
30 km/h			4420	5045	5670	6320	6970	7125	7280	7435	7590	7710	7825	7945	8060
65 km/h			4250	4850	5450	6075	6700	6850	7000	7150	7300	7415	7525	7640	7750
65 km/h Dual	2640	3190	3740	4270	4800	5350	5900	6030	6160	6290	6420	6520	6620	6720	6820

* Refer to the notes at the end of the tables of this range

MICHELIN AXIOBIB

Tyre specifications and pressure table (bar & psi). Load per tyre in kg*

Ø inches	Description	CAI	S mm	OD mm	LR mm	RC mm	Recommended Rim		Acceptable Rim		Tube (Code)	75% internal volume (litres)	Tread depth (mm)		
42	IF 900/60 R42 186D TL	111950	881	2123	952	6304	DW30B (A)					1,230	65		
Bar	0.4	0.6	0.8	1.0	1.2	1.4	1.6	1.7	1.8	1.9	2.0	2.1	2.2	2.3	2.4
Psi	6	9	12	15	17	20	23	25	26	28	29	30	32	33	35
10 km/h			5750	6615	7475	8340	9200	9415	9635	9850	10065	10280	10495	10710	10925
30 km/h			5200	5980	6760	7540	8320	8515	8710	8905	9100	9295	9490	9685	9880
65 km/h			5000	5750	6500	7250	8000	8190	8375	8565	8750	8940	9125	9315	9500
65 km/h Dual	3210	3805	4400	5060	5720	6380	7040	7205	7370	7535	7700	7865	8030	8195	8360

Ø inches	Description	CAI	S mm	OD mm	LR mm	RC mm	Recommended Rim		Acceptable Rim		Tube (Code)	75% internal volume (litres)	Tread depth (mm)		
42	IF 710/75 R42 176D TL	037489	715	2161	954	6395	DW25B (A)				802	953	66		
Bar	0.4	0.6	0.8	1.0	1.2	1.4	1.6	1.7	1.8	1.9	2.0	2.1	2.2	2.3	2.4
Psi	6	9	12	15	17	20	23	25	26	28	29	30	32	33	35
10 km/h			5190	5935	6680	7425	8165								
30 km/h			4695	5370	6040	6715	7385								
65 km/h			4515	5165	5810	6455	7100								
65 km/h Dual	2845	3415	3980	4550	5115	5685	6250								

Ø inches	Description	CAI	S mm	OD mm	LR mm	RC mm	Recommended Rim		Acceptable Rim		Tube (Code)	75% internal volume (litres)	Tread depth (mm)		
46	IF 750/75 R46 186D TL	487001	761	2287	1043	6819	DW25B (A)					1,147	71		
Bar	0.4	0.6	0.8	1.0	1.2	1.4	1.6	1.7	1.8	1.9	2.0	2.1	2.2	2.3	2.4
Psi	6	9	12	15	17	20	23	25	26	28	29	30	32	33	35
10 km/h			5920	6700	7475	8340	9200	9415	9635	9850	10065	10280	10495	10710	10925
30 km/h			5355	6060	6760	7540	8320	8515	8710	8905	9100	9295	9490	9685	9880
65 km/h			5150	5825	6500	7250	8000	8190	8375	8565	8750	8940	9125	9315	9500
65 km/h Dual	3210	3870	4530	5125	5720	6380	7040	7205	7370	7535	7700	7865	8030	8195	8360

* Refer to the notes at the end of the tables of this range

MICHELIN AXIOBIB

Tyre specifications and pressure table (bar & psi). Load per tyre in kg*

Ø inches	Description			CAI	S mm	OD mm	LR mm	RC mm	Recommended Rim		Acceptable Rim		Tube (Code)	75% internal volume (litres)		Tread depth (mm)
46	IF 900/65 R46 190D TL			162365	915	2322	1038	6888	MW30B (A)					1,450		71
Bar	0.4	0.6	0.8	1.0	1.2	1.4	1.6	1.7	1.8	1.9	2.0	2.1	2.2	2.3	2.4	
Psi	6	9	12	15	17	20	23	25	26	28	29	30	32	33	35	
10 km/h				6670	7650	8625	9345	10065	10330	10595	10860	11125	11390	11660	11925	12190
30 km/h				6030	6915	7800	8450	9100	9340	9580	9820	10060	10300	10545	10785	11025
65 km/h				5800	6650	7500	8125	8750	8980	9215	9445	9675	9905	10140	10370	10600
65 km/h Dual	3630	4370		5105	5855	6600	7150	7700	7905	8110	8310	8515	8720	8925	9125	9330

***IMPORTANT:**

The inflation pressure must always be appropriate for the load per tyre, the speed of travel and the work to be done. Our recommendations above were correct as of the time of publication of these tables (June 2018). Technical data is subject to change without prior notice.

- When using single tyre configuration:
 - add 0.4 bar for use on slopes of more than 20%
 - add 0.4 bar for intense road use exceeding 50%



MICHELIN MACHXBIB

**EXCEPTIONAL VALUE
& VERSALITY FOR
HIGH-POWERED TRACTORS**



For High-Powered tractors **160 HP and over**



VERSATILE: ideal for road transport & efficient in the field

- Speed of up to 65 km/h⁽¹⁾
- Load capacity in the field
- Damage resistance



4% FUEL SAVINGS, 1 litre/hr compared to the main market competitor⁽²⁾
(for a consumption on the road of 25 l/hr)



Excellent **TRACTIVE PERFORMANCE**



Proven **CASING ROBUSTNESS**

(1) When authorized by the laws in force in the country - depending on the size

(2) Analytic Test at MICHELIN Tracks Ladoux Centre, in June 2014 comparing Fuel Consumption of 710/70R42 Michelin MachxBib and 710/70R42 Trelleborg TM900

SIZES

600/65 R28 154D TL

600/70 R28 157D TL

710/55 R30 153D TL

600/70 R30 TL 152D

680/75 R32 164A8/161B TL XM28

650/60 R34 159D/155E TL **NEW**

650/65 R34 161D/157E TL **NEW**

650/75 R38 169A8/169B TL

710/70 R38 171D TL

650/85 R38 173A8/173B TL

800/70 R38 173D TL

900/50 R42 168D TL

710/70 R42 173D TL

710/75 R42 175D/171E TL **NEW**

620/70 R46 162A8/162B TL XM28

MICHELIN MACHXBIB

Tyre specifications and pressure table (bar & psi). Load per tyre in kg*

Ø inches	Description	CAI	S mm	OD mm	LR mm	RC mm	Recommended Rim		Acceptable Rim		Tube (Code)	75% internal volume (litres)	Tread depth (mm)
28	600/65 R28 154D TL	055335	615	1502	666	4449	DW20B (A)	DW18LW18L	717	425	51		
Bar	0.4 0.6 0.8 1.0 1.2 1.4 1.6 1.7 1.8 1.9 2.0 2.2 2.4 2.6 2.8	1.0 1.2 1.4 1.6 1.7 2.0 2.3 2.5 2.6 2.8 2.9 3.2 3.5 3.8 4.1											
Psi	6 9 12 15 17 20 23 25 26 28 29 32 35 38 41												
10 km/h **	2250 2605 2960	3315 3660 4005	4350 4455 4565	4670 4775 4990	5205 5415 5630								
30 km/h	1690 2010 2335	2655 2975 3300	3705 3795 3880	3965 4140 4310									
40 km/h	1915 2250	2580 2870 3160	3450 3530 3615	3695 3780 3940	4105								
50 km/h	1840 2155	2465 2780 3045	3305 3385 3465	3545 3625 3780	3940								
65 km/h		2360 2625 2885	3150 3225 3300	3375 3450 3600	3750								
40 km/h Dual	1415 1700 1985	2270 2525 2780	3035 3110 3180	3255 3325 3470	3615								

Ø inches	Description	CAI	S mm	OD mm	LR mm	RC mm	Recommended Rim		Acceptable Rim		Tube (Code)	75% internal volume (litres)	Tread depth (mm)
28	600/70 R28 157D TL	438598	614	1572	701	4663	DW20B (A)	DW18L	717	495	52		
Bar	0.4 0.6 0.8 1.0 1.2 1.4 1.6 1.7 1.8 1.9 2.0 2.2 2.4 2.6 2.8	1.0 1.2 1.4 1.6 1.7 2.0 2.3 2.5 2.6 2.8 2.9 3.2 3.5 3.8 4.1											
Psi	6 9 12 15 17 20 23 25 26 28 29 32 35 38 41												
10 km/h **	2475 2860 3245	3630 4045 4460	4875 5025 5175	5325 5475 5655	5835 6010 6190								
30 km/h	1860 2230 2600	2970 3340 3710	4080 4165 4245	4330 4415 4580	4745								
40 km/h	2135 2480	2825 3180 3530	3885 3965 4045	4120 4200 4360	4515								
50 km/h	2050 2380	2715 3045 3385	3725 3800 3875	3950 4030 4180	4330								
65 km/h		2580 2905 3225	3550 3620 3695	3765 3840 3980	4125								
40 km/h Dual	1560 1870 2180	2490 2800 3110	3420 3490 3560	3630 3700 3835	3975								

Ø inches	Description	CAI	S mm	OD mm	LR mm	RC mm	Recommended Rim		Acceptable Rim		Tube (Code)	75% internal volume (litres)	Tread depth (mm)
30	710/55 R30 153D TL	992342	678	1518	668	4489	DW23B (A)					506	50
Bar	0.4 0.6 0.8 1.0 1.2 1.4 1.6 1.7 1.8 1.9 2.0 2.2 2.4 2.6 2.8	1.0 1.2 1.4 1.6 1.7 2.0 2.3 2.5 2.6 2.8 2.9 3.2 3.5 3.8 4.1											
Psi	6 9 12 15 17 20 23 25 26 28 29 32 35 38 41												
10 km/h **	2475 2960 3370	3775 4185 4590	5000 5160 5320	5480									
30 km/h	1900 2270 2655	3040 3430 3815	4200										
40 km/h	2165 2530	2900 3265 3635	4000										
50 km/h	2075 2425	2775 3130 3480	3830										
65 km/h		2300 2650 2985	3315 3650										
40 km/h Dual	1590 1905 2225	2550 2870 3195	3515										

* Refer to the notes at the end of the tables of this range

MICHELIN MACHXBIB

Tyre specifications and pressure table (bar & psi). Load per tyre in kg*

Ø inches	Description	CAI	S mm	OD mm	LR mm	RC mm	Recommended Rim		Acceptable Rim	Tube (Code)	75% internal volume (litres)	Tread depth (mm)			
30	600/70 R30 TL 152D	334318	613	1605	706	4745	DW20B (A)		DW18L	737	456	56			
Bar	0.4	0.6	0.8	1.0	1.2	1.4	1.6	1.7	1.8	1.9	2.0	2.2	2.4	2.6	2.8
Psi	6	9	12	15	17	20	23	25	26	28	29	32	35	38	41
10 km/h **	2500	3000	3250	3750	4175	4600	5025	5125	5230	5330					
30 km/h	1915	2300	2680	3060	3440	3820	4200								
40 km/h		2190	2550	2910	3275	3635	3995								
50 km/h		2100	2445	2790	3140	3485	3830								
65 km/h			2335	2665	2960	3255	3550								
40 km/h Dual	1605	1930	2250	2565	2885	3200	3520								

Ø inches	Description	CAI	S mm	OD mm	LR mm	RC mm	Recommended Rim		Acceptable Rim	Tube (Code)	75% internal volume (litres)	Tread depth (mm)			
32	680/75 R32 164A8/161B TL XM28	123582	675	1865	819	5512	DW21B (A)		DW20B (A)	831	743	58			
Bar	0.4	0.6	0.8	1.0	1.2	1.4	1.6	1.7	1.8	1.9	2.0	2.2	2.4	2.6	2.8
Psi	6	9	12	15	17	20	23	25	26	28	29	32	35	38	41
10 km/h	3230	4430	4900	5375	5845	6320	6790	7030	7265	7500					
30 km/h	2510	3480	3855	4230	4600	4975	5350								
40 km/h		3250	3600	3950	4300	4650	5000								
50 km/h		3050	3365	3680	4000	4315	4630								
40 km/h Dual	1970	2860	3170	3475	3785	4090	4400								

Ø inches	Description	CAI	S mm	OD mm	LR mm	RC mm	Recommended Rim		Acceptable Rim	Tube (Code)	75% internal volume (litres)	Tread depth (mm)			
34	650/60 R34 159D/155E TL NEW	549996	655	1663	750	4944	DW21B (A)		DW20B (A) DW23B (A)	823	500	58			
Bar	0.4	0.6	0.8	1.0	1.2	1.4	1.6	1.7	1.8	1.9	2.0	2.2	2.4	2.6	2.8
Psi	6	9	12	15	17	20	23	25	26	28	29	32	35	38	41
10 km/h **	2475	2800	3125	3450	3885	4320	4755	4975	5190	5410	5625	5860	6095	6330	6565
30 km/h	1900	2285	2665	3050	3435	3815	4200	4305	4410	4510	4615	4825	5030		
40 km/h		2190	2550	2910	3275	3635	3995	4095	4195	4295	4395	4590	4790		
50 km/h		2100	2445	2795	3140	3490	3835	3930	4025	4120	4215	4405	4595		
65 km/h			2300	2640	2975	3310	3650	3740	3830	3920	4015	4195	4375		
70 km/h				2095	2400	2710	3015	3320	3390	3460	3530	3600	3735	3875	
40 km/h Dual	1590	1910	2230	2555	2875	3195	3515	3605	3690	3780	3865	4040	4215		

* Refer to the notes at the end of the tables of this range

MICHELIN MACHXBIB

Tyre specifications and pressure table (bar & psi). Load per tyre in kg*

Ø inches	Description	CAI	S mm	OD mm	LR mm	RC mm	Recommended Rim	Acceptable Rim	Tube (Code)	75% internal volume (litres)	Tread depth (mm)				
34	650/65 R34 161D/157E TL NEW	817386	657	1723	779	5125	DW21B (A)	DW20B (A) DW23B (A)	823	555	58				
Bar	0.4 0.6 0.8 1.0 1.2 1.4 1.6 1.7 1.8 1.9 2.0	1.0 1.2 1.4 1.6 1.7 1.8 1.9 2.0 2.2 2.4 2.6 2.8													
Psi	6 9 12 15 17 20 23 25 26 28 29 32 35 38 41														
10 km/h **	2700	3090	3475	3865	4290	4720	5145	5360	5575	5785	6000	6235	6470	6705	6940
30 km/h	2070	2470	2865	3265	3660	4055	4455	4565	4670	4780	4890	5105	5320		
40 km/h		2385	2755	3130	3500	3875	4245	4350	4450	4555	4655	4860	5065		
50 km/h		2290	2645	3000	3360	3715	4070	4170	4265	4365	4465	4660	4855		
65 km/h			2575	2900	3225	3550	3875	3970	4065	4155	4250	4440	4625		
70 km/h			2345	2640	2935	3230	3525	3600	3675	3750	3825	3975	4125		
40 km/h Dual	1735	2070	2400	2735	3070	3400	3735	3825	3915	4005	4095	4275	4455		

Ø inches	Description	CAI	S mm	OD mm	LR mm	RC mm	Recommended Rim	Acceptable Rim	Tube (Code)	75% internal volume (litres)	Tread depth (mm)				
38	650/75 R38 169A8/169B TL	219467	664	1948	880	5761	DW23B (A)	MW23B (A)	804	731	61				
Bar	0.4 0.6 0.8 1.0 1.2 1.4 1.6 1.7 1.8 1.9 2.0 2.2 2.4 2.6 2.8														
Psi	6 9 12 15 17 20 23 25 26 28 29 32 35 38 41														
10 km/h **	3360	4150	4940	5730	6050	6370	6690	6860	7025	7195	7360	7695	8030	8365	8700
30 km/h	2410	3075	3745	4410	4680	4950	5220	5345	5470	5590	5715	5965	6210		
40 km/h		2725	3435	4140	4385	4630	4875	4990	5105	5220	5340	5570	5800		
50 km/h			2725	3435	4140	4385	4630	4875	4990	5105	5220	5340	5800		
40 km/h Dual	1965	2525	3085	3645	3860	4075	4290	4390	4495	4595	4700	4900	5105		

Ø inches	Description	CAI	S mm	OD mm	LR mm	RC mm	Recommended Rim	Acceptable Rim	Tube (Code)	75% internal volume (litres)	Tread depth (mm)					
38	710/70 R38 171D TL	708197	713	1973	871	5804	DW23B (A)	DW25B (A) MW23B (A) MW25B (A)	804	811	62					
Bar	0.4 0.6 0.8 1.0 1.2 1.4 1.6 1.7 1.8 1.9 2.0 2.2 2.4 2.6 2.8															
Psi	6 9 12 15 17 20 23 25 26 28 29 32 35 38 41															
10 km/h **	3640	4250	4860	5470	6010	6550	7095	7365	7635	7905	8175	8440	8700	8965	9225	
30 km/h	2790	3340	3890	4445	4995	5545	6095	6215	6340	6460	6585	6825	7070			
40 km/h		3190	3725	4255	4770	5290	5805	5920	6040	6155	6270	6505	6735			
50 km/h			3060	3570	4080	4575	5070	5565	5675	5790	5900	6010	6235	6455		
65 km/h				3350	3840	4325	4815	5300	5405	5515	5620	5725	5940	6150		
40 km/h Dual	2340	2800	3260	3725	4185	4645	5105	5210	5310	5415	5515	5720	5925			

* Refer to the notes at the end of the tables of this range

MICHELIN MACHXBIB

Tyre specifications and pressure table (bar & psi). Load per tyre in kg*

Ø inches	Description	CAI	S mm	OD mm	LR mm	RC mm	Recommended Rim	Acceptable Rim	Tube (Code)	75% internal volume (litres)	Tread depth (mm)				
38	650/85 R38 173A8/173B TL	118628	686	2063	924	6092	DW23B (A)	DW20B (A) MW23B (A)	804	860	64				
Bar	0.4	0.6	0.8	1.0	1.2	1.4	1.6	1.7	1.8	1.9	2.0	2.2	2.4	2.6	2.8
Psi	6	9	12	15	17	20	23	25	26	28	29	32	35	38	41
10 km/h Cyc Dual				6400	6760	7120	7480	7665	7855	8040	8230	8605	8975	9350	9725
10 km/h **	3750	4640	5530	6420	6780	7140	7500	7690	7875	8065	8250	8625	9000	9375	9750
30 km/h	2700	3445	4195	4940	5245	5545	5850	5990	6125	6265	6405	6680	6955		
40 km/h		3000	3820	4640	4910	5180	5450	5580	5715	5845	5975	6240	6500		
50 km/h		3000	3820	4640	4910	5180	5450	5580	5715	5845	5975	6240	6500		
40 km/h Dual	2200	2830	3455	4085	4320	4560	4795	4910	5025	5140	5260	5490	5720		

Ø inches	Description	CAI	S mm	OD mm	LR mm	RC mm	Recommended Rim	Acceptable Rim	Tube (Code)	75% internal volume (litres)	Tread depth (mm)				
38	800/70 R38 173D TL	887730	809	2066	899	6093	DW25B (A)	DW27B (A) MW25B (A)		1,071	61				
Bar	0.4	0.6	0.8	1.0	1.2	1.4	1.6	1.7	1.8	1.9	2.0	2.2	2.4	2.6	2.8
Psi	6	9	12	15	17	20	23	25	26	28	29	32	35	38	41
10 km/h Cyc Dual				5260	6155	7045	7940	8390	8835	9280	9725				
10 km/h **	4400	5115	5825	6540	7255	7965	8680	9035	9395	9750					
30 km/h	3375	4060	4740	5425	6110	6790	7475								
40 km/h		3860	4510	5165	5815	6470	7120								
50 km/h		3700	4325	4950	5575	6200	6825								
65 km/h			4115	4710	5305	5905	6500								
40 km/h Dual	2825	3400	3970	4545	5115	5690	6260								

Ø inches	Description	CAI	S mm	OD mm	LR mm	RC mm	Recommended Rim	Acceptable Rim	Tube (Code)	75% internal volume (litres)	Tread depth (mm)				
42	900/50 R42 168D TL	832458	853	1970	870	5826	DW27B (A)	DW28B (A) DW30B (A)		923	55				
Bar	0.4	0.6	0.8	1.0	1.2	1.4	1.6	1.7	1.8	1.9	2.0	2.2	2.4	2.6	2.8
Psi	6	9	12	15	17	20	23	25	26	28	29	32	35	38	41
10 km/h **	3825	4575	5195	5810	6430	7045	7665	7910	8155	8400					
30 km/h	2930	3510	4095	4680	5270	5855	6440								
40 km/h		3340	3900	4455	5015	5570	6130								
50 km/h		3200	3735	4270	4810	5345	5880								
65 km/h			3550	4090	4595	5095	5600								
40 km/h Dual	2455	2940	3430	3925	4415	4910	5400								

* Refer to the notes at the end of the tables of this range

MICHELIN MACHXBIB

Tyre specifications and pressure table (bar & psi). Load per tyre in kg*

Ø inches	Description	CAI	S mm	OD mm	LR mm	RC mm	Recommended Rim		Acceptable Rim	Tube (Code)	75% internal volume (litres)	Tread depth (mm)			
42	710/70 R42 173D TL	790388	721	2088	932	6195	DW23B (A)		DW25B (A) MW23B (A) MW25B (A)	802	872	64			
Bar	0.4	0.6	0.8	1.0	1.2	1.4	1.6	1.7	1.8	1.9	2.0	2.2	2.4	2.6	2.8
Psi	6	9	12	15	17	20	23	25	26	28	29	32	35	38	41
10 km/h Cyc Dual				4390	5190	5985	6785	7185	7580	7980	8380	8715	9050	9390	9725
10 km/h **	3750	4375	5000	5625	6210	6795	7380	7675	7965	8260	8550	8850	9150	9450	9750
30 km/h	2875	3470	4065	4660	5250	5845	6440	6570	6700	6830	6960	7215	7475		
40 km/h		3285	3835	4380	4965	5545	6130	6255	6380	6500	6625	6875	7120		
50 km/h		3150	3675	4200	4760	5320	5880	6000	6115	6235	6355	6590	6825		
65 km/h				4000	4535	5065	5600	5715	5825	5940	6050	6275	6500		
40 km/h Dual	2410	2910	3405	3905	4405	4900	5400	5510	5615	5725	5835	6050	6265		

Ø inches	Description	CAI	S mm	OD mm	LR mm	RC mm	Recommended Rim		Acceptable Rim	Tube (Code)	75% internal volume (litres)	Tread depth (mm)			
42	710/75 R42 175D/171E TL NEW	015540	693	2158	975	6424	DW23B (A)		DW25B (A)	802	867	61			
Bar	0.4	0.6	0.8	1.0	1.2	1.4	1.6	1.7	1.8	1.9	2.0	2.2	2.4	2.6	2.8
Psi	6	9	12	15	17	20	23	25	26	28	29	32	35	38	41
10 km/h **	3975	4775	5575	6375	7050	7725	8400	8740	9075	9415	9750	10125	10500	10875	11250
30 km/h	3050	3690	4335	4975	5615	6260	6900	7030	7160	7290	7420	7675	7935		
40 km/h		3560	4160	4765	5365	5970	6570	6695	6815	6940	7065	7310	7555		
50 km/h		3415	3990	4570	5145	5725	6300	6420	6535	6655	6775	7010	7245		
65 km/h			3750	4315	4875	5440	6000	6115	6225	6340	6450	6675	6900		
70 km/h			3415	3925	4440	4950	5460	5545	5635	5720	5805	5980	6150		
40 km/h Dual	2555	3095	3630	4170	4705	5245	5780	5890	6000	6105	6215	6435	6650		

Ø inches	Description	CAI	S mm	OD mm	LR mm	RC mm	Recommended Rim		Acceptable Rim	Tube (Code)	75% internal volume (litres)	Tread depth (mm)			
46	620/70 R46 162A8/162B TL XM28	122723	621	2061	926	6122	DW20B (A)			834	698	57			
Bar	0.4	0.6	0.8	1.0	1.2	1.4	1.6	1.7	1.8	1.9	2.0	2.2	2.4	2.6	2.8
Psi	6	9	12	15	17	20	23	25	26	28	29	32	35	38	41
10 km/h	3060	4200	4650	5100	5550	6005	6455	6680	6905	7130					
30 km/h	2390	3300	3655	4010	4370	4725	5080								
40 km/h		3090	3420	3755	4085	4420	4750								
50 km/h		3090	3420	3755	4085	4420	4750								
40 km/h Dual	1865	2720	3010	3305	3595	3890	4180								

***IMPORTANT:**

The inflation pressure must always be appropriate for the load per tyre, the speed of travel and the work to be done. Our recommendations above were correct as of the time of publication of these tables (June 2018). Technical data is subject to change without prior notice.

- For ploughing and other field applications subject to high torque, use the 30 km/h column.
- When using single tyre configuration:
 - add 0.4 bar for use on slopes of more than 20%
 - add 0.4 bar for intense road use exceeding 50%
- **10 km/h LT (Low Torque) (max speed 10 km/h).



MICHELIN XEOBIB

**EVERY DAY TRACTION
ON ALL SURFACES
AT LESS THAN 15 PSI 1 BAR**



For tractors from 80 to 220 HP

(for high load / torque, use MICHELIN MACHXBIB / AXIOBIB / AXIOBIB 2)



Very High Flexion Standard (VF)



YIELDS

- Potential increase in yields of up to 4% year⁽¹⁾
- Excellent **SERVICE LIFE**



FUEL SAVINGS

- Supports fuel saving in field operations



COMFORT

- Absorbs shocks & surface irregularities

(1) Harper Adams University 2014/2016

SIZES

VF 480/60 R28 134D TL

VF 520/60 R28 138D TL

VF 600/60 R28 146D TL

VF 600/60 R30 147D TL

VF 600/60 R34 149D TL

VF 600/60 R38 151D TL

VF 650/60 R38 155D TL

VF 710/60 R38 160D TL

VF 650/60 R42 157D TL

VF 710/60 R42 161D TL

MICHELIN XEOBIB

Tyre specifications and pressure table (bar & psi). Load per tyre in kg*

Ø inches	Description	CAI	S mm	OD mm	LR mm	RC mm	Recommended Rim	Acceptable Rim	Tube (Code)	75% internal volume (litres)	Tread depth (mm)
28	VF 480/60 R28 134D TL	312875	488	1298	567	3831	DW16L	W16L	821	218	45
Bar	0.4	0.5	0.6	0.7	0.8	0.9	1.0	1.8			
Psi	6	7	9	10	12	13	15	26			
10 km/h	1450	1605	1760	1900	2035	2185	2330				
30 km/h	1345	1490	1630	1760	1885	2025	2160				
65 km/h	1320	1460	1600	1725	1850	1985	2120				
65 km/h Dual	1160	1285	1410	1520	1630	1750	1865				
10 km/h Charg Fr							3000				

Ø inches	Description	CAI	S mm	OD mm	LR mm	RC mm	Recommended Rim	Acceptable Rim	Tube (Code)	75% internal volume (litres)	Tread depth (mm)
28	VF 520/60 R28 138D TL	510495	534	1338	579	3942	DW18L	W18L	822	260	46
Bar	0.4	0.5	0.6	0.7	0.8	0.9	1.0	1.8			
Psi	6	7	9	10	12	13	15	26			
10 km/h	1650	1815	1980	2125	2265	2430	2595				
30 km/h	1530	1685	1835	1970	2100	2255	2405				
65 km/h	1500	1650	1800	1930	2060	2210	2360				
65 km/h Dual	1320	1455	1585	1700	1815	1945	2075				
10 km/h Charg Fr							3350				

Ø inches	Description	CAI	S mm	OD mm	LR mm	RC mm	Recommended Rim	Acceptable Rim	Tube (Code)	75% internal volume (litres)	Tread depth (mm)
28	VF 600/60 R28 146D TL	665184	597	1429	610	4198	DW20B (A)		822	365	48
Bar	0.4	0.5	0.6	0.7	0.8	0.9	1.0	1.8			
Psi	6	7	9	10	12	13	15	26			
10 km/h	2035	2250	2465	2690	2915	3110	3300				
30 km/h	1885	2085	2285	2495	2705	2885	3060				
65 km/h	1850	2045	2240	2445	2650	2825	3000				
65 km/h Dual	1630	1800	1970	2150	2330	2485	2640				
10 km/h Charg Fr							4250				

Ø inches	Description	CAI	S mm	OD mm	LR mm	RC mm	Recommended Rim	Acceptable Rim	Tube (Code)	75% internal volume (litres)	Tread depth (mm)
30	VF 600/60 R30 147D TL	065253	603	1493	633	4379	DW20B (A)		757	383	50
Bar	0.4	0.5	0.6	0.7	0.8	0.9	1.0	1.8			
Psi	6	7	9	10	12	13	15	26			
10 km/h	2145	2340	2530	2765	3000	3195	3385				
30 km/h	1990	2170	2345	2565	2780	2960	3135				
65 km/h	1950	2125	2300	2515	2725	2900	3075				
65 km/h Dual	1715	1870	2025	2215	2400	2555	2705				
10 km/h Charg Fr							4375				

* Refer to the notes at the end of the tables of this range

MICHELIN XEOBIB

Tyre specifications and pressure table (bar & psi). Load per tyre in kg*

Ø inches	Description	CAI	S mm	OD mm	LR mm	RC mm	Recommended Rim	Acceptable Rim	Tube (Code)	75% internal volume (litres)	Tread depth (mm)
34	VF 600/60 R34 149D TL	664777	595	1595	690	4699	DW20B (A)		823	416	48
Bar	0.4	0.5	0.6	0.7	0.8	0.9	1.0	1.8			
Psi	6	7	9	10	12	13	15	26			
10 km/h	2265	2470	2675	2935	3190	3385	3575				
30 km/h	2100	2290	2480	2720	2960	3140	3315				
65 km/h	2060	2245	2430	2665	2900	3075	3250				
65 km/h Dual	1815	1980	2140	2345	2550	2705	2860				
10 km/h Charg Fr								4550			

Ø inches	Description	CAI	S mm	OD mm	LR mm	RC mm	Recommended Rim	Acceptable Rim	Tube (Code)	75% internal volume (litres)	Tread depth (mm)
38	VF 600/60 R38 151D TL	349257	549	1698	749	5023	DW20B (A)	MW20B (A)	824	452	52
Bar	0.4	0.5	0.6	0.7	0.8	0.9	1.0	1.8			
Psi	6	7	9	10	12	13	15	26			
10 km/h	2400	2620	2835	3070	3300	3550	3795				
30 km/h	2225	2425	2625	2845	3060	3290	3520				
65 km/h	2180	2380	2575	2790	3000	3225	3450				
65 km/h Dual	1920	2095	2265	2455	2640	2840	3035				

Ø inches	Description	CAI	S mm	OD mm	LR mm	RC mm	Recommended Rim	Acceptable Rim	Tube (Code)	75% internal volume (litres)	Tread depth (mm)
38	VF 650/60 R38 155D TL	454365	677	1735	749	5108	DW23B (A)	MW23B (A)	825	539	52
Bar	0.4	0.5	0.6	0.7	0.8	0.9	1.0	1.8			
Psi	6	7	9	10	12	13	15	26			
10 km/h	2675	2935	3190	3495	3795	4030	4265				
30 km/h	2480	2720	2960	3240	3520	3740	3955				
65 km/h	2430	2665	2900	3175	3450	3665	3875				
65 km/h Dual	2140	2345	2550	2795	3035	3225	3410				

Ø inches	Description	CAI	S mm	OD mm	LR mm	RC mm	Recommended Rim	Acceptable Rim	Tube (Code)	75% internal volume (litres)	Tread depth (mm)
38	VF 710/60 R38 160D TL	324138	712	1814	794	5356	DW25B (A)	MW25B (A)	825	665	54
Bar	0.4	0.5	0.6	0.7	0.8	0.9	1.0	1.8			
Psi	6	7	9	10	12	13	15	26			
10 km/h	3080	3385	3685	3975	4265	4610	4950				
30 km/h	2855	3135	3415	3685	3955	4275	4590				
65 km/h	2800	3075	3350	3615	3875	4190	4500				
65 km/h Dual	2465	2710	2950	3180	3410	3685	3960				

* Refer to the notes at the end of the tables of this range

MICHELIN XEOBIB

Tyre specifications and pressure table (bar & psi). Load per tyre in kg*

Ø inches	Description	CAI	S mm	OD mm	LR mm	RC mm	Recommended Rim	Acceptable Rim	Tube (Code)	75% internal volume (litres)	Tread depth (mm)
42	VF 650/60 R42 157D TL	220583	660	1840	810	5441	DW23B (A)	DW20B(A) (NRO)	802	645	58
Bar	0.4	0.5	0.6	0.7	0.8	0.9	1.0	1.8			
Psi	6	7	9	10	12	13	15	26			
10 km/h	2835	3110	3385	3645	3905	4225	4540				
30 km/h	2625	2880	3135	3380	3620	3915	4210				
65 km/h	2575	2825	3075	3315	3550	3840	4125				
65 km/h Dual	2265	2485	2705	2915	3125	3380	3630				

Ø inches	Description	CAI	S mm	OD mm	LR mm	RC mm	Recommended Rim	Acceptable Rim	Tube (Code)	75% internal volume (litres)	Tread depth (mm)
42	VF 710/60 R42 161D TL	144294	716	1920	843	5675	DW25B (A)	MW25B (A)	802	713	57
Bar	0.4	0.5	0.6	0.7	0.8	0.9	1.0	1.8			
Psi	6	7	9	10	12	13	15	26			
10 km/h	3190	3495	3795	4170	4540	4815	5090				
30 km/h	2960	3240	3520	3865	4210	4465	4720				
65 km/h	2900	3175	3450	3790	4125	4375	4625				
65 km/h Dual	2550	2795	3035	3335	3630	3850	4070				

***IMPORTANT:**

The inflation pressure must always be appropriate for the load per tyre, the speed of travel and the work to be done. Our recommendations above were correct as of the time of publication of these tables (June 2018). Technical data is subject to change without prior notice.

- When using single tyre configuration:
 - add 0.4 bar for use on slopes of more than 20%
 - add 0.4 bar for intense road use exceeding 50%
- 10 km/h Fr Loader: application with front-end loader at max. speed of 10 km/h.



MICHELIN MULTIBIB

**EXCELLENT LONGEVITY
FOR INCREASED MILEAGE**



For tractors from 80 to 220 HP

(for high load / torque, use MICHELIN MACHXBIB / AXIOBIB / AXIOBIB 2)



VERSATILITY

- Great performance in the field & on the road



PRODUCTIVITY

- High traction to save time & fuel
- Soil protection
- Capable of speeds of up to 65 kph⁽¹⁾



SERVICE LIFE

- Extra deep tread compared to competitors⁽²⁾



COMFORT

- Excellent road handling
- Increased ride comfort

(1) When authorised by the laws in force in the country

(2) For 650/65 R42 size

SIZES

320/65 R16 107D TL

320/65 R18 109A8/106B TL XM108

340/65 R18 113A8/110B TL XM108

420/65 R20 125A8/125B TL XM108

440/65 R20 128D TL

420/65 R24 126D TL

420/65 R24 126A8/126B TL XM108

440/65 R24 128D TL

480/65 R24 133D TL

540/65 R24 140D TL

420/65 R28 135D TL

440/65 R28 131D TL

480/65 R28 136D TL

540/65 R28 142D TL

540/65 R30 143D TL

540/65 R34 145D TL

540/65 R34 152D TL

600/65 R34 151D TL

540/65 R38 147D TL

600/65 R38 153D TL

650/65 R38 157D TL

650/65 R42 158D TL

MICHELIN MULTIBIB

Tyre specifications and pressure table (bar & psi). Load per tyre in kg*

Ø inches	Description	CAI	S mm	OD mm	LR mm	RC mm	Recommended Rim	Acceptable Rim	Tube (Code)	75% internal volume (litres)	Tread depth (mm)				
16	320/65 R16 107D TL	494658	300	827	368	2452	W8	W10L W8L W9	827	65	29				
Bar	0.4	0.5	0.6	0.8	1.0	1.2	1.4	1.6	1.7	1.8	1.9	2.0	2.2	2.4	2.7
Psi	6	7	9	12	15	17	20	23	25	26	28	29	32	35	39
10 km/h	530	580	630	760	885	1015	1140	1270	1395	1460					
30 km/h	520	570	620	720	820	920	1025	1125							
40 km/h		530	580	680	775	875	975	1070							
50 km/h		510	555	650	745	840	935	1025							
65 km/h		490	535	625	710	800	890	975							

Ø inches	Description	CAI	S mm	OD mm	LR mm	RC mm	Recommended Rim	Acceptable Rim	Tube (Code)	75% internal volume (litres)	Tread depth (mm)				
18	320/65 R18 109A8/106B TL XM108	123898	309	875	389	2594	W9	W10	444	64	28				
Bar	0.4	0.5	0.6	0.8	1.0	1.2	1.4	1.6	1.7	1.8	1.9	2.0	2.2	2.4	2.7
Psi	6	7	9	12	15	17	20	23	25	26	28	29	32	35	39
10 km/h	400	535	670	805	940	1075	1210	1345	1415	1480	1550				
30 km/h	390	500	610	710	805	905	1000	1100							
40 km/h		460	570	665	755	850	940	1030							
50 km/h		430	520	605	690	780	865	950							

Ø inches	Description	CAI	S mm	OD mm	LR mm	RC mm	Recommended Rim	Acceptable Rim	Tube (Code)	75% internal volume (litres)	Tread depth (mm)				
18	340/65 R18 113A8/110B TL XM108	123888	319	911	407	2719	W9	W10	444	76	29				
Bar	0.4	0.5	0.6	0.8	1.0	1.2	1.4	1.6	1.7	1.8	1.9	2.0	2.2	2.4	2.7
Psi	6	7	9	12	15	17	20	23	25	26	28	29	32	35	39
10 km/h	450	600	750	900	1050	1200	1355	1505	1580	1655	1730				
30 km/h	440	560	680	790	900	1010	1120	1230							
40 km/h		520	630	735	840	945	1050	1150							
50 km/h		480	580	675	770	870	965	1060							

Ø inches	Description	CAI	S mm	OD mm	LR mm	RC mm	Recommended Rim	Acceptable Rim	Tube (Code)	75% internal volume (litres)	Tread depth (mm)				
20	420/65 R20 125A8/125B TL XM108	122702	396	1064	461	3135	W11	W10 W12	664	140	36				
Bar	0.4	0.5	0.6	0.8	1.0	1.2	1.4	1.6	1.7	1.8	1.9	2.0	2.2	2.4	2.7
Psi	6	7	9	12	15	17	20	23	25	26	28	29	32	35	39
10 km/h	970	1140	1310	1525	1735	1950	2160	2375	2480						
30 km/h	770	925	1080	1255	1425	1600	1770								
40 km/h		830	1010	1170	1330	1490	1650								
50 km/h		830	1010	1115	1225	1330	1435	1545	1595	1650					

* Refer to the notes at the end of the tables of this range

MICHELIN MULTIBIB

Tyre specifications and pressure table (bar & psi). Load per tyre in kg*

Ø inches	Description	CAI	S mm	OD mm	LR mm	RC mm	Recommended Rim		Acceptable Rim		Tube (Code)	75% internal volume (litres)	Tread depth (mm)		
20	440/65 R20 128D TL	675464	445	1090	475	3260	W14L		W13 W15L		664	157	44		
Bar	0.4	0.5	0.6	0.8	1.0	1.2	1.4	1.6	1.7	1.8	1.9	2.0	2.2	2.4	2.7
Psi	6	7	9	12	15	17	20	23	25	26	28	29	32	35	39
10 km/h	1200	1295	1390	1570	1750	1930	2125	2315		2510	2605	2700			
30 km/h	920	1020	1120	1305	1485	1670	1870	2070							
40 km/h			1070	1245	1415	1590	1780	1970							
50 km/h			1025	1165	1310	1450	1670	1890							
65 km/h			975	1135	1290	1450	1625	1800							
40 km/h Dual	770	855	940	1095	1245	1400	1570	1735							

Ø inches	Description	CAI	S mm	OD mm	LR mm	RC mm	Recommended Rim		Acceptable Rim		Tube (Code)	75% internal volume (litres)	Tread depth (mm)		
24	420/65 R24 126D TL	171560	392	1156	508	3416	W12		11 DW12 W11		700	159	38		
Bar	0.4	0.5	0.6	0.8	1.0	1.2	1.4	1.6	1.7	1.8	1.9	2.0	2.2	2.4	2.7
Psi	6	7	9	12	15	17	20	23	25	26	28	29	32	35	39
10 km/h	1200	1315	1425	1575	1725	1875	2025	2175		2365	2455	2550			
30 km/h	920	1010	1095	1290	1480	1670	1815	1955							
40 km/h			1040	1225	1410	1590	1725	1860							
50 km/h			1000	1175	1350	1525	1655	1785							
65 km/h			950	1120	1285	1450	1575	1700							

Ø inches	Description	CAI	S mm	OD mm	LR mm	RC mm	Recommended Rim		Acceptable Rim		Tube (Code)	75% internal volume (litres)	Tread depth (mm)		
24	420/65 R24 126A8/126B TL XM108	122712	395	1160	507	3425	W11		W10 W12		700	150	37		
Bar	0.4	0.5	0.6	0.8	1.0	1.2	1.4	1.6	1.7	1.8	1.9	2.0	2.2	2.4	2.7
Psi	6	7	9	12	15	17	20	23	25	26	28	29	32	35	39
10 km/h	990	1170	1350	1570	1785	2005	2225	2440	2550						
30 km/h	790	950	1110	1290	1465	1645	1820								
40 km/h		850	1040	1205	1370	1535	1700								
50 km/h		850	1040	1150	1260	1370	1480	1590	1645	1700					

* Refer to the notes at the end of the tables of this range

MICHELIN MULTIBIB

Tyre specifications and pressure table (bar & psi). Load per tyre in kg*

Ø inches	Description	CAI	S mm	OD mm	LR mm	RC mm	Recommended Rim	Acceptable Rim	Tube (Code)	75% internal volume (litres)	Tread depth (mm)
24	440/65 R24 128D TL	426389	439	1187	529	3519	DW14L	DW13 DW15L W13 W14L W15L	703	178	44
Bar	0.4 0.5 0.6 0.8 1.0 1.2 1.4 1.6 1.7	0.8 1.0 1.2 1.4 1.6 1.7 1.8 1.9 2.0	2.2 2.4 2.7								
Psi	6 7 9 12 15 17 20 23 25	12 15 17 20 23 26 28 29 32	35 39								
10 km/h	1285 1370 1450 1655 1855 2060 2225 2395	2560 2640 2725									
30 km/h	980 1080 1180 1380 1580 1780 1925 2070										
40 km/h	1130 1320 1510 1700 1835 1970										
50 km/h	1080 1265 1445 1630 1760 1890										
65 km/h	1030 1205 1375 1550 1675 1800										
40 km/h Dual	820 910 995 1160 1330 1495 1615 1735										

Ø inches	Description	CAI	S mm	OD mm	LR mm	RC mm	Recommended Rim	Acceptable Rim	Tube (Code)	75% internal volume (litres)	Tread depth (mm)
24	480/65 R24 133D TL	531721	483	1240	546	3667	DW15L	DW14L W14L W15L	710	218	46
Bar	0.4 0.5 0.6 0.8 1.0 1.2 1.4 1.6 1.7	1.8 1.9 2.0 2.2 2.4 2.7									
Psi	6 7 9 12 15 17 20 23 25	26 28 29 32 35 39									
10 km/h	1450 1575 1700 1920 2140 2360 2560 2755	2955 3050 3150									
30 km/h	1120 1240 1360 1575 1795 2010 2190 2370										
40 km/h	1290 1500 1710 1920 2090 2260										
50 km/h	1240 1440 1640 1840 2000 2160										
65 km/h	1180 1370 1560 1750 1905 2060										
40 km/h Dual	940 1040 1135 1320 1505 1690 1840 1990										

Ø inches	Description	CAI	S mm	OD mm	LR mm	RC mm	Recommended Rim	Acceptable Rim	Tube (Code)	75% internal volume (litres)	Tread depth (mm)
24	540/65 R24 140D TL	097057	532	1312	573	3873	DW16L	DW18L W16L W18L	710	287	48
Bar	0.4 0.5 0.6 0.8 1.0 1.2 1.4 1.6 1.7	1.8 1.9 2.0 2.2 2.4 2.7									
Psi	6 7 9 12 15 17 20 23 25	26 28 29 32 35 39									
10 km/h	1750 1875 2000 2265 2535 2800 3040 3275	3515 3630 3750									
30 km/h	1360 1485 1610 1885 2165 2440 2660 2880										
40 km/h	1530 1795 2055 2320 2530 2740										
50 km/h	1470 1725 1975 2230 2430 2630										
65 km/h	1400 1640 1880 2120 2310 2500										
40 km/h Dual	1140 1245 1345 1575 1810 2040 2225 2410										

* Refer to the notes at the end of the tables of this range

MICHELIN MULTIBIB

Tyre specifications and pressure table (bar & psi). Load per tyre in kg*

Ø inches	Description	CAI	S mm	OD mm	LR mm	RC mm	Recommended Rim		Acceptable Rim		Tube (Code)	75% internal volume (litres)	Tread depth (mm)		
28	420/65 R28 135D TL	778211	390	1238	558	3680	W11	W12	W12	W12	732	177	44		
Bar	0.4	0.5	0.6	0.8	1.0	1.2	1.4	1.6	1.7	1.8	1.9	2.0	2.2	2.4	2.7
Psi	6	7	9	12	15	17	20	23	25	26	28	29	32	35	39

Ø inches	Description	CAI	S mm	OD mm	LR mm	RC mm	Recommended Rim		Acceptable Rim		Tube (Code)	75% internal volume (litres)	Tread depth (mm)		
28	440/65 R28 131D TL	386212	437	1291	579	3833	DW14L	DW15L W13 W14L W15L	DW15L W13 W14L W15L	DW15L W13 W14L W15L	821	198	43		
Bar	0.4	0.5	0.6	0.8	1.0	1.2	1.4	1.6	1.7	1.8	1.9	2.0	2.2	2.4	2.7
Psi	6	7	9	12	15	17	20	23	25	26	28	29	32	35	39
10 km/h	1360	1480	1600	1795	1985	2180	2360	2540	2720	2810	2900				
30 km/h	1060	1155	1250	1465	1685	1900	2070	2240							
40 km/h			1190	1395	1605	1810	1975	2140							
50 km/h			1140	1335	1535	1730	1890	2050							
65 km/h			1090	1275	1465	1650	1800	1950							
40 km/h Dual	890	970	1045	1230	1410	1595	1740	1885							

Ø inches	Description	CAI	S mm	OD mm	LR mm	RC mm	Recommended Rim		Acceptable Rim		Tube (Code)	75% internal volume (litres)	Tread depth (mm)		
28	480/65 R28 136D TL	897574	476	1339	596	3970	DW15L	DW14L W14L W15L	DW14L W14L W15L	DW14L W14L W15L	822	242	45		
Bar	0.4	0.5	0.6	0.8	1.0	1.2	1.4	1.6	1.7	1.8	1.9	2.0	2.2	2.4	2.7
Psi	6	7	9	12	15	17	20	23	25	26	28	29	32	35	39
10 km/h	1550	1675	1800	2035	2265	2500	2715	2925	3140	3245	3350				
30 km/h	1180	1310	1440	1690	1940	2190	2385	2580							
40 km/h			1370	1605	1845	2080	2265	2450							
50 km/h			1310	1540	1770	2000	2175	2350							
65 km/h			1250	1465	1685	1900	2070	2240							
40 km/h Dual	990	1100	1205	1415	1620	1830	1995	2155							

Ø inches	Description	CAI	S mm	OD mm	LR mm	RC mm	Recommended Rim		Acceptable Rim		Tube (Code)	75% internal volume (litres)	Tread depth (mm)		
28	540/65 R28 142D TL	792274	529	1427	630	4223	DW16L	DW18L W16L W18L	DW18L W16L W18L	DW18L W16L W18L	822	318	48		
Bar	0.4	0.5	0.6	0.8	1.0	1.2	1.4	1.6	1.7	1.8	1.9	2.0	2.2	2.4	2.7
Psi	6	7	9	12	15	17	20	23	25	26	28	29	32	35	39
10 km/h	1900	2040	2180	2455	2725	3000	3250	3500	3750	3875	4000				
30 km/h	1440	1585	1730	2015	2295	2580	2815	3050							
40 km/h			1640	1910	2180	2450	2675	2900							
50 km/h			1580	1835	2095	2350	2565	2780							
65 km/h			1500	1745	1995	2240	2445	2650							
40 km/h Dual	1205	1325	1445	1680	1920	2155	2355	2550							

* Refer to the notes at the end of the tables of this range

MICHELIN MULTIBIB

Tyre specifications and pressure table (bar & psi). Load per tyre in kg*

Ø inches	Description	CAI	S mm	OD mm	LR mm	RC mm	Recommended Rim	Acceptable Rim	Tube (Code)	75% internal volume (litres)	Tread depth (mm)				
30	540/65 R30 143D TL	223153	527	1472	648	4353	DW16L	DW18L W16L W18L	754	333	48				
Bar	0.4	0.5	0.6	0.8	1.0	1.2	1.4	1.6	1.7	1.8	1.9	2.0	2.2	2.4	2.7
Psi	6	7	9	12	15	17	20	23	25	26	28	29	32	35	39
10 km/h	1950	2095	2240	2520	2795	3075	3340	3600		3865	3995	4125			
30 km/h	1480	1630	1780	2070	2360	2650	2890	3130							
40 km/h			1700	1975	2245	2520	2750	2980							
50 km/h			1630	1895	2155	2420	2640	2860							
65 km/h			1550	1800	2050	2300	2515	2725							
40 km/h Dual	1240	1370	1495	1735	1980	2220	2420	2620							

Ø inches	Description	CAI	S mm	OD mm	LR mm	RC mm	Recommended Rim	Acceptable Rim	Tube (Code)	75% internal volume (litres)	Tread depth (mm)				
34	540/65 R34 145D TL	712064	530	1574	693	4655	DW16L	DW18L W16L W18L	704	364	48				
Bar	0.4	0.5	0.6	0.8	1.0	1.2	1.4	1.6	1.7	1.8	1.9	2.0	2.2	2.4	2.7
Psi	6	7	9	12	15	17	20	23	25	26	28	29	32	35	39
10 km/h	2060	2210	2360	2655	2955	3250	3530	3815		4095	4235	4375			
30 km/h	1560	1730	1900	2225	2555	2880	3110	3340							
40 km/h			1810	2120	2430	2740	2960	3180							
50 km/h			1730	2030	2330	2630	2840	3050							
65 km/h			1650	1935	2215	2500	2700	2900							
40 km/h Dual	1310	1455	1595	1865	2140	2410	2605	2800							

Ø inches	Description	CAI	S mm	OD mm	LR mm	RC mm	Recommended Rim	Acceptable Rim	Tube (Code)	75% internal volume (litres)	Tread depth (mm)				
34	540/65 R34 152D TL	214036	530	1590	709	4716	DW16L	DW18L W16L W18L	704	364	48				
Bar	0.4	0.5	0.6	0.8	1.0	1.2	1.4	1.6	1.7	1.8	1.9	2.0	2.2	2.4	2.7
Psi	6	7	9	12	15	17	20	23	25	26	28	29	32	35	39
10 km/h	2060	2210	2360	2655	2955	3250	3530	3815		4095	4235	4375	4625	4875	5215
30 km/h	1560	1730	1900	2225	2555	2880	3110	3340		3525	3620	3710	3895	4080	
40 km/h			1810	2120	2430	2740	2960	3180		3360	3445	3535	3715	3890	
50 km/h			1730	2030	2330	2630	2840	3050		3220	3305	3390	3560	3730	
65 km/h			1650	1935	2215	2500	2700	2900		3065	3145	3225	3390	3550	
40 km/h Dual	1310	1455	1595	1865	2140	2410	2605	2800		2955	3035	3110	3265	3420	

* Refer to the notes at the end of the tables of this range

MICHELIN MULTIBIB

Tyre specifications and pressure table (bar & psi). Load per tyre in kg*

Ø inches	Description	CAI	S mm	OD mm	LR mm	RC mm	Recommended Rim	Acceptable Rim	Tube (Code)	75% internal volume (litres)	Tread depth (mm)				
34	600/65 R34 151D TL	557189	594	1654	732	4897	DW20B (A)	DW18LW18L	823	464	54				
Bar	0.4	0.5	0.6	0.8	1.0	1.2	1.4	1.6	1.7	1.8	1.9	2.0	2.2	2.4	2.7
Psi	6	7	9	12	15	17	20	23	25	26	28	29	32	35	39
10 km/h	2430	2615	2800	3160	3515	3875	4195	4515	4830	4990	5150				
30 km/h	1840	2040	2240	2605	2975	3340	3655	3970							
40 km/h			2140	2485	2835	3180	3480	3780							
50 km/h			2050	2385	2715	3050	3335	3620							
65 km/h			1950	2265	2585	2900	3175	3450							
40 km/h Dual	1540	1715	1885	2190	2495	2800	3065	3325							

Ø inches	Description	CAI	S mm	OD mm	LR mm	RC mm	Recommended Rim	Acceptable Rim	Tube (Code)	75% internal volume (litres)	Tread depth (mm)				
38	540/65 R38 147D TL	114518	529	1675	745	4965	DW16L	DW18LW16LW18L	824	394	48				
Bar	0.4	0.5	0.6	0.8	1.0	1.2	1.4	1.6	1.7	1.8	1.9	2.0	2.2	2.4	2.7
Psi	6	7	9	12	15	17	20	23	25	26	28	29	32	35	39
10 km/h	2180	2340	2500	2815	3135	3450	3745	4040	4330	4480	4625				
30 km/h	1670	1840	2010	2325	2645	2960	3250	3540							
40 km/h			1920	2220	2520	2820	3095	3370							
50 km/h			1840	2125	2415	2700	2965	3230							
65 km/h			1750	2025	2300	2575	2825	3075							
40 km/h Dual	1400	1545	1690	1955	2215	2480	2725	2965							

Ø inches	Description	CAI	S mm	OD mm	LR mm	RC mm	Recommended Rim	Acceptable Rim	Tube (Code)	75% internal volume (litres)	Tread depth (mm)				
38	600/65 R38 153D TL	228045	595	1768	779	5229	DW20B (A)	DW18LW18L	825	500	53				
Bar	0.4	0.5	0.6	0.8	1.0	1.2	1.4	1.6	1.7	1.8	1.9	2.0	2.2	2.4	2.7
Psi	6	7	9	12	15	17	20	23	25	26	28	29	32	35	39
10 km/h	2575	2775	2970	3355	3740	4125	4455	4790	5120	5285	5450				
30 km/h	1960	2165	2370	2760	3150	3540	3870	4200							
40 km/h			2260	2630	3000	3370	3685	4000							
50 km/h			2160	2515	2875	3230	3530	3830							
65 km/h			2060	2400	2735	3075	3365	3650							
40 km/h Dual	1645	1820	1990	2315	2640	2965	3245	3520							

* Refer to the notes at the end of the tables of this range

MICHELIN MULTIBIB

Tyre specifications and pressure table (bar & psi). Load per tyre in kg*

Ø inches	Description	CAI	S mm	OD mm	LR mm	RC mm	Recommended Rim	Acceptable Rim	Tube (Code)	75% internal volume (litres)	Tread depth (mm)				
38	650/65 R38 157D TL	292904	646	1819	801	5380	DW20B (A)		825	602	56				
Bar	0.4	0.5	0.6	0.8	1.0	1.2	1.4	1.6	1.7	1.8	1.9	2.0	2.2	2.4	2.7
Psi	6	7	9	12	15	17	20	23	25	26	28	29	32	35	39
10 km/h	2900	3125	3350	3775	4200	4625	5005	5390		5770	5960	6150			
30 km/h	2190	2420	2650	3090	3530	3970	4355	4740							
40 km/h			2520	2940	3360	3780	4150	4520							
50 km/h			2420	2820	3220	3620	3975	4330							
65 km/h			2300	2685	3065	3450	3790	4125							
40 km/h Dual	1835	2030	2220	2590	2955	3325	3655	3980							

Ø inches	Description	CAI	S mm	OD mm	LR mm	RC mm	Recommended Rim	Acceptable Rim	Tube (Code)	75% internal volume (litres)	Tread depth (mm)				
42	650/65 R42 158D TL	167733	638	1931	858	5722	DW20B (A)		802	647	57				
Bar	0.4	0.5	0.6	0.8	1.0	1.2	1.4	1.6	1.7	1.8	1.9	2.0	2.2	2.4	2.7
Psi	6	7	9	12	15	17	20	23	25	26	28	29	32	35	39
10 km/h	3000	3225	3450	3885	4315	4750	5155	5565		5970	6170	6375			
30 km/h	2300	2545	2790	3260	3730	4200	4545	4890							
40 km/h			2660	3105	3555	4000	4325	4650							
50 km/h			2550	2975	3405	3830	4145	4460							
65 km/h			2430	2835	3245	3650	3950	4250							
40 km/h Dual	1930	2135	2340	2735	3125	3520	3805	4090							

***IMPORTANT:**

The inflation pressure must always be appropriate for the load per tyre, the speed of travel and the work to be done. Our recommendations above were correct as of the time of publication of these tables (June 2018). Technical data is subject to change without prior notice.

- For ploughing and other field applications subject to high torque, use the 30 km/h column.
- When using single tyre configuration:
 - add 0.4 bar for use on slopes of more than 20%
 - add 0.4 bar for intense road use exceeding 50%
- **10 km/h LT (Low Torque) (max speed 10 km/h).



MICHELIN OMNIBIB

**GREATER VERSATILITY
TO OPTIMISE YOUR COSTS**



For tractors from **70 to 180 HP**

(for high load / torque, use MICHELIN MACHXBIB / AXIOBIB / AXIOBIB 2)



VERSATILITY

- Specially designed to withstand the stresses of work with front loaders
- Up to 14%⁽¹⁾ more **LOAD CAPACITY** versus equivalent standard radial sizes
- Excellent **STABILITY & MANOEUVRABILITY** for work with livestock
- Super **TRACTION** capacity



SERVICE LIFE

- Proven casing endurance
- Damage resistance

(1) Depending on tyre sizes & compared with the equivalent size in MICHELIN AGRIBIB

SIZES

280/70 R16 112D TL
280/70 R20 116D TL
320/70 R24 116D TL
360/70 R24 122D TL
380/70 R24 125D TL
420/70 R24 130D TL

480/70 R24 138D TL
380/70 R28 127D TL
420/70 R28 133D TL
480/70 R28 140D TL
480/70 R30 141D TL
480/70 R34 143D TL

520/70 R34 148D TL
480/70 R38 145D TL
520/70 R38 150D TL
580/70 R38 155D TL
620/70 R42 160D TL

MICHELIN OMNIBIB

Tyre specifications and pressure table (bar & psi). Load per tyre in kg*

Ø inches	Description	CAI	S mm	OD mm	LR mm	RC mm	Recommended Rim		Acceptable Rim		Tube (Code)	75% internal volume (litres)	Tread depth (mm)		
16	280/70 R16 112D TL	747196	276	805	360	2400	W9		W10L W8 W8L		184	45	29		
Bar	0.4	0.5	0.6	0.7	0.8	0.9	1.0	1.2	1.4	1.5	1.6	1.7	1.8	1.9	2.0
Psi	6	7	9	10	12	13	15	17	20	22	23	25	26	28	29
10 km/h	580	625	665	710	755	795	840	930	1015	1060	1100	1145	1190	1230	1275
30 km/h	445	490	535	580	625	670	715	800	890	935	980	1020	1060	1095	1135
40 km/h			505	550	590	635	675	760	845	890	930	965	1005	1040	1080
50 km/h			485	525	565	610	650	730	815	855	895	930	965	1000	1035
65 km/h			460	500	540	575	615	695	770	810	850	885	920	950	985
40 km/h Dual	375	410	445	485	520	560	595	670	745	785	820	855	885	920	950

Ø inches	Description	CAI	S mm	OD mm	LR mm	RC mm	Recommended Rim		Acceptable Rim		Tube (Code)	75% internal volume (litres)	Tread depth (mm)		
20	280/70 R20 116D TL	263806	268	904	409	2690	W9		W10 W8		533	61	29		
Bar	0.4	0.5	0.6	0.7	0.8	0.9	1.0	1.2	1.4	1.5	1.6	1.7	1.8	1.9	2.0
Psi	6	7	9	10	12	13	15	17	20	22	23	25	26	28	29
10 km/h	640	690	740	785	835	885	935	1035	1130	1180	1230	1280	1325	1375	1425
30 km/h	490	540	590	640	690	740	795	895	995	1045	1095	1140	1180	1225	1270
40 km/h			565	615	660	710	755	850	945	995	1040	1080	1125	1165	1205
50 km/h			540	585	630	680	725	815	910	955	1000	1040	1080	1120	1160
65 km/h			515	560	600	645	690	775	865	905	950	990	1025	1065	1100

Ø inches	Description	CAI	S mm	OD mm	LR mm	RC mm	Recommended Rim		Acceptable Rim		Tube (Code)	75% internal volume (litres)	Tread depth (mm)		
24	320/70 R24 116D TL	415039	323	1101	497	3274	W10		W11 W9		692	94	40		
Bar	0.4	0.5	0.6	0.7	0.8	0.9	1.0	1.2	1.4	1.5	1.6	1.7	1.8	1.9	2.0
Psi	6	7	9	10	12	13	15	17	20	22	23	25	26	28	29
10 km/h	870	935	995	1060	1125	1185	1250	1375	1500	1565	1630	1690	1755	1815	1880
30 km/h	670	735	800	865	925	990	1055	1185	1310	1375	1440				
40 km/h			760	820	880	945	1005	1125	1250	1310	1370				
50 km/h			720	780	840	895	955	1075	1190	1250	1310				
65 km/h			690	745	800	860	915	1025	1140	1195	1250				
40 km/h Dual	560	615	670	720	775	830	885	990	1100	1150	1205				

* Refer to the notes at the end of the tables of this range

MICHELIN OMNIBIB

Tyre specifications and pressure table (bar & psi). Load per tyre in kg*

Ø inches	Description	CAI	S mm	OD mm	LR mm	RC mm	Recommended Rim		Acceptable Rim		Tube (Code)	75% internal volume (litres)	Tread depth (mm)		
24	360/70 R24 122D TL	198698	373	1153	513	3418	W11		W10 W12L		692	137	43		
Bar	0.4	0.5	0.6	0.7	0.8	0.9	1.0	1.2	1.4	1.5	1.6	1.7	1.8	1.9	2.0
Psi	6	7	9	10	12	13	15	17	20	22	23	25	26	28	29
10 km/h	1040	1115	1190	1265	1345	1420	1495	1645	1795	1870	1950	2025	2100	2175	2250
30 km/h	790	870	945	1025	1105	1180	1260	1415	1575	1650	1730				
40 km/h			900	975	1050	1120	1195	1345	1490	1565	1640				
50 km/h			870	940	1010	1085	1155	1295	1440	1510	1580				
65 km/h			825	895	960	1030	1095	1230	1365	1435	1500				
40 km/h Dual	665	730	795	860	925	990	1055	1185	1315	1380	1445				

Ø inches	Description	CAI	S mm	OD mm	LR mm	RC mm	Recommended Rim		Acceptable Rim		Tube (Code)	75% internal volume (litres)	Tread depth (mm)		
24	380/70 R24 125D TL	085816	399	1188	528	3520	W12		W11 W13		700	161	45		
Bar	0.4	0.5	0.6	0.7	0.8	0.9	1.0	1.2	1.4	1.5	1.6	1.7	1.8	1.9	2.0
Psi	6	7	9	10	12	13	15	17	20	22	23	25	26	28	29
10 km/h	1130	1215	1300	1385	1470	1550	1635	1805	1975	2060	2145	2225	2310	2395	2480
30 km/h	860	945	1035	1120	1205	1295	1380	1555	1725	1815	1900				
40 km/h			990	1070	1155	1235	1320	1480	1645	1730	1810				
50 km/h			950	1030	1105	1185	1260	1420	1575	1650	1730				
65 km/h			900	975	1050	1125	1200	1350	1500	1575	1650				
40 km/h Dual	725	795	865	940	1010	1085	1155	1300	1445	1520	1590				

Ø inches	Description	CAI	S mm	OD mm	LR mm	RC mm	Recommended Rim		Acceptable Rim		Tube (Code)	75% internal volume (litres)	Tread depth (mm)		
24	420/70 R24 130D TL	829095	436	1251	553	3702	W13		DW14L W12L W14L		703	203	46		
Bar	0.4	0.5	0.6	0.7	0.8	0.9	1.0	1.2	1.4	1.5	1.6	1.7	1.8	1.9	2.0
Psi	6	7	9	10	12	13	15	17	20	22	23	25	26	28	29
10 km/h	1310	1405	1505	1600	1695	1790	1890	2080	2275	2370	2465	2560	2660	2755	2850
30 km/h	1010	1110	1205	1305	1405	1500	1600	1795	1995	2090	2190				
40 km/h			1130	1225	1320	1415	1510	1700	1890	1985	2080				
50 km/h			1080	1170	1265	1355	1450	1630	1815	1910	2000				
65 km/h			1030	1115	1205	1290	1380	1550	1725	1815	1900				
40 km/h Dual	845	920	995	1080	1160	1245	1330	1495	1665	1745	1830				

* Refer to the notes at the end of the tables of this range

MICHELIN OMNIBIB

Tyre specifications and pressure table (bar & psi). Load per tyre in kg*

Ø inches	Description	CAI	S mm	OD mm	LR mm	RC mm	Recommended Rim		Acceptable Rim	Tube (Code)	75% internal volume (litres)	Tread depth (mm)
24	480/70 R24 138D TL	375821	494	1327	578	3916	DW15L		DW14L DW16L W14LW15L W16L	710	276	48
Bar	0.4 0.5 0.6 0.7 0.8 0.9 1.0 1.2 1.4	1.5 1.6 1.7 1.8 1.9 2.0										
Psi	6 7 9 10 12 13 15 17 20	22 23 25 26 28 29										
10 km/h	1590 1710 1835 1955 2080 2200 2320 2565 2810	2930 3055 3175 3295 3420 3540										
30 km/h	1220 1345 1470 1595 1715 1840 1965 2215 2460	2585 2710										
40 km/h	1410 1525 1645 1760 1880 2110 2345	2465 2580										
50 km/h	1350 1465 1575 1690 1800 2030 2255	2365 2480										
65 km/h	1285 1395 1500 1610 1715 1930 2145	2255 2360										
40 km/h Dual	1020 1130 1240 1345 1445 1550 1655 1860 2070	2170 2275										

Ø inches	Description	CAI	S mm	OD mm	LR mm	RC mm	Recommended Rim		Acceptable Rim	Tube (Code)	75% internal volume (litres)	Tread depth (mm)
28	380/70 R28 127D TL	118587	390	1294	580	3842	W12		W11 W13	732	179	45
Bar	0.4 0.5 0.6 0.7 0.8 0.9 1.0 1.2 1.4	1.5 1.6 1.7 1.8 1.9 2.0										
Psi	6 7 9 10 12 13 15 17 20	22 23 25 26 28 29										
10 km/h	1200 1290 1380 1470 1560 1645 1735 1915 2095	2185 2275 2360 2450 2540 2630										
30 km/h	920 1010 1100 1195 1285 1375 1465 1645 1830	1920 2010										
40 km/h	1040 1130 1215 1305 1390 1570 1745	1830 1920										
50 km/h	1000 1085 1170 1250 1335 1505 1670	1755 1840										
65 km/h	950 1030 1110 1190 1270 1430 1590	1670 1750										
40 km/h Dual	770 845 915 990 1070 1145 1225 1375 1530	1610 1685										

Ø inches	Description	CAI	S mm	OD mm	LR mm	RC mm	Recommended Rim		Acceptable Rim	Tube (Code)	75% internal volume (litres)	Tread depth (mm)
28	420/70 R28 133D TL	532215	436	1354	602	4012	W13		DW14L W12 W14L	821	231	46
Bar	0.4 0.5 0.6 0.7 0.8 0.9 1.0 1.2 1.4	1.5 1.6 1.7 1.8 1.9 2.0										
Psi	6 7 9 10 12 13 15 17 20	22 23 25 26 28 29										
10 km/h	1390 1495 1605 1710 1815 1920 2030 2240 2455	2560 2665 2770 2880 2985 3090										
30 km/h	1060 1170 1280 1390 1495 1605 1715 1935 2150	2260 2370										
40 km/h	1230 1335 1435 1540 1640 1850 2055	2155 2260										
50 km/h	1180 1280 1375 1475 1570 1770 1965	2060 2160										
65 km/h	1120 1215 1310 1400 1495 1685 1870	1965 2060										
40 km/h Dual	890 985 1080 1170 1260 1350 1440 1625 1805	1895 1985										

* Refer to the notes at the end of the tables of this range

MICHELIN OMNIBIB

Tyre specifications and pressure table (bar & psi). Load per tyre in kg*

Ø inches	Description	CAI	S mm	OD mm	LR mm	RC mm	Recommended Rim	Acceptable Rim	Tube (Code)	75% internal volume (litres)	Tread depth (mm)				
28	480/70 R28 140D TL	570026	500	1427	632	4217	DW15L	DW14L DW16L W14L W15L W16L	822	302	48				
Bar	0.4	0.5	0.6	0.7	0.8	0.9	1.0	1.2	1.4	1.5	1.6	1.7	1.8	1.9	2.0
Psi	6	7	9	10	12	13	15	17	20	22	23	25	26	28	29
10 km/h	1730	1855	1985	2110	2235	2360	2490	2740	2995	3120	3245	3370	3500	3625	3750
30 km/h	1320	1450	1580	1710	1840	1970	2100	2360	2620	2750	2880				
40 km/h			1490	1615	1740	1865	1990	2240	2490	2615	2740				
50 km/h			1430	1550	1670	1790	1910	2150	2390	2510	2630				
65 km/h			1360	1475	1590	1700	1815	2045	2270	2385	2500				
40 km/h Dual	1110	1210	1310	1420	1530	1640	1750	1970	2190	2300	2410				

Ø inches	Description	CAI	S mm	OD mm	LR mm	RC mm	Recommended Rim	Acceptable Rim	Tube (Code)	75% internal volume (litres)	Tread depth (mm)				
30	480/70 R30 141D TL	599351	498	1482	656	4388	DW15L	DW14L DW16L W14L W15L W16L	754	317	48				
Bar	0.4	0.5	0.6	0.7	0.8	0.9	1.0	1.2	1.4	1.5	1.6	1.7	1.8	1.9	2.0
Psi	6	7	9	10	12	13	15	17	20	22	23	25	26	28	29
10 km/h	1770	1900	2030	2160	2295	2425	2555	2815	3075	3205	3340	3470	3600	3730	3860
30 km/h	1360	1495	1625	1760	1895	2025	2160	2425	2695	2825	2960				
40 km/h			1530	1660	1790	1915	2045	2305	2560	2690	2820				
50 km/h			1470	1595	1715	1840	1960	2210	2455	2575	2700				
65 km/h			1400	1520	1635	1755	1870	2105	2340	2460	2575				
40 km/h Dual	1135	1245	1350	1465	1575	1690	1800	2030	2255	2365	2480				

Ø inches	Description	CAI	S mm	OD mm	LR mm	RC mm	Recommended Rim	Acceptable Rim	Tube (Code)	75% internal volume (litres)	Tread depth (mm)				
34	480/70 R34 143D TL	280033	497	1593	713	4728	DW15L	DW14L DW16L W14L W15L W16L	704	345	50				
Bar	0.4	0.5	0.6	0.7	0.8	0.9	1.0	1.2	1.4	1.5	1.6	1.7	1.8	1.9	2.0
Psi	6	7	9	10	12	13	15	17	20	22	23	25	26	28	29
10 km/h	1880	2020	2155	2295	2435	2570	2710	2985	3260	3400	3540	3675	3815	3950	4090
30 km/h	1440	1580	1720	1865	2005	2145	2285	2565	2850	2990	3130				
40 km/h			1640	1775	1910	2040	2175	2445	2710	2845	2980				
50 km/h			1580	1710	1835	1965	2090	2350	2605	2730	2860				
65 km/h			1500	1625	1745	1870	1990	2235	2480	2605	2725				
40 km/h Dual	1205	1325	1445	1565	1680	1800	1915	2155	2390	2505	2625				

* Refer to the notes at the end of the tables of this range

MICHELIN OMNIBIB

Tyre specifications and pressure table (bar & psi). Load per tyre in kg*

Ø inches	Description	CAI	S mm	OD mm	LR mm	RC mm	Recommended Rim		Acceptable Rim		Tube (Code)	75% internal volume (litres)	Tread depth (mm)		
34	520/70 R34 148D TL	939411	535	1651	730	4887	DW16L		DW15L DW18L W15L W16L W18L		823	422	53		
Bar	0.4	0.5	0.6	0.7	0.8	0.9	1.0	1.2	1.4	1.5	1.6	1.7	1.8	1.9	2.0
Psi	6	7	9	10	12	13	15	17	20	22	23	25	26	28	29
10 km/h	2100	2265	2430	2595	2760	2920	3085	3415	3745	3910	4075	4235	4400	4565	4730
30 km/h	1610	1780	1945	2115	2280	2450	2615	2950	3285	3455	3620				
40 km/h			1860	2020	2180	2335	2495	2815	3130	3290	3450				
50 km/h			1790	1940	2095	2245	2400	2700	3005	3160	3310				
65 km/h			1700	1845	1990	2135	2280	2570	2860	3005	3150				
40 km/h Dual	1350	1495	1640	1780	1920	2060	2200	2475	2755	2895	3035				

Ø inches	Description	CAI	S mm	OD mm	LR mm	RC mm	Recommended Rim		Acceptable Rim		Tube (Code)	75% internal volume (litres)	Tread depth (mm)		
38	480/70 R38 145D TL	936570	498	1694	759	5030	DW15L		DW14L DW16L W14L W15L W16L		786	377	52		
Bar	0.4	0.5	0.6	0.7	0.8	0.9	1.0	1.2	1.4	1.5	1.6	1.7	1.8	1.9	2.0
Psi	6	7	9	10	12	13	15	17	20	22	23	25	26	28	29
10 km/h	1980	2130	2275	2425	2575	2720	2870	3165	3460	3610	3760	3905	4055	4200	4350
30 km/h	1520	1670	1825	1975	2125	2280	2430	2735	3035	3190	3340				
40 km/h			1750	1895	2035	2180	2320	2610	2895	3035	3180				
50 km/h			1680	1815	1955	2090	2230	2500	2775	2915	3050				
65 km/h			1600	1730	1860	1990	2120	2380	2640	2770	2900				
40 km/h Dual	1270	1405	1540	1665	1790	1915	2040	2295	2545	2670	2795				

Ø inches	Description	CAI	S mm	OD mm	LR mm	RC mm	Recommended Rim		Acceptable Rim		Tube (Code)	75% internal volume (litres)	Tread depth (mm)		
38	520/70 R38 150D TL	833744	539	1766	782	5229	DW16L		DW15L DW18L W15L W16L W18L		824	464	53		
Bar	0.4	0.5	0.6	0.7	0.8	0.9	1.0	1.2	1.4	1.5	1.6	1.7	1.8	1.9	2.0
Psi	6	7	9	10	12	13	15	17	20	22	23	25	26	28	29
10 km/h	2250	2425	2600	2770	2945	3120	3295	3640	3990	4160	4335	4510	4685	4855	5030
30 km/h	1730	1905	2085	2260	2435	2615	2790	3145	3495	3675	3850				
40 km/h			1970	2140	2310	2480	2650	2990	3330	3500	3670				
50 km/h			1890	2055	2215	2380	2540	2870	3195	3355	3520				
65 km/h			1800	1955	2110	2265	2420	2730	3040	3195	3350				
40 km/h Dual	1445	1590	1735	1885	2035	2185	2335	2630	2930	3080	3230				

* Refer to the notes at the end of the tables of this range

MICHELIN OMNIBIB

Tyre specifications and pressure table (bar & psi). Load per tyre in kg*

Ø inches	Description	CAI	S mm	OD mm	LR mm	RC mm	Recommended Rim		Acceptable Rim		Tube (Code)	75% internal volume (litres)		Tread depth (mm)	
38	580/70 R38 155D TL	001240	601	1836	815	5440	DW18L	W18L	825	590	56				
Bar	0.4	0.5	0.6	0.7	0.8	0.9	1.0	1.2	1.4	1.5	1.6	1.7	1.8	1.9	2.0
Psi	6	7	9	10	12	13	15	17	20	22	23	25	26	28	29
10 km/h	2630	2830	3030	3225	3425	3625	3825	4220	4620	4815	5015	5215	5415	5610	5810
30 km/h	2010	2215	2420	2625	2825	3030	3235	3645	4050	4255	4460				
40 km/h			2320	2510	2705	2895	3090	3470	3855	4050	4240				
50 km/h			2230	2415	2600	2780	2965	3335	3700	3885	4070				
65 km/h			2120	2295	2470	2645	2820	3175	3525	3700	3875				
40 km/h Dual	1685	1865	2045	2215	2385	2550	2720	3060	3395	3565	3735				

Ø inches	Description	CAI	S mm	OD mm	LR mm	RC mm	Recommended Rim		Acceptable Rim		Tube (Code)	75% internal volume (litres)		Tread depth (mm)	
42	620/70 R42 160D TL	989457	639	1953	863	5781	DW20B (A)	DW18L	802	658	58				
Bar	0.4	0.5	0.6	0.7	0.8	0.9	1.0	1.2	1.4	1.5	1.6	1.7	1.8	1.9	2.0
Psi	6	7	9	10	12	13	15	17	20	22	23	25	26	28	29
10 km/h	3090	3320	3550	3775	4005	4235	4465	4920	5380	5605	5835	6065	6295	6520	6750
30 km/h	2370	2605	2840	3075	3305	3540	3775	4245	4710	4945	5180				
40 km/h			2660	2885	3115	3340	3570	4020	4475	4705	4930				
50 km/h			2550	2770	2985	3205	3420	3860	4295	4510	4730				
65 km/h			2430	2635	2845	3050	3260	3670	4085	4295	4500				
40 km/h Dual	1985	2165	2340	2540	2740	2940	3140	3535	3935	4135	4335				

***IMPORTANT:**

The inflation pressure must always be appropriate for the load per tyre, the speed of travel and the work to be done. Our recommendations above were correct as of the time of publication of these tables (June 2018). Technical data is subject to change without prior notice.

- For ploughing and other field applications subject to high torque, use the 30 km/h column.
- When using single tyre configuration:
 - add 0.4 bar for use on slopes of more than 20%
 - add 0.4 bar for intense road use exceeding 50%
- **10 km/h LT (Low Torque) (max speed 10 km/h).



MICHELIN YELDBIB

**THE LOW-PRESSURE TYRE
FOR HIGH-POWERED
ROW-CROP APPLICATIONS**



For tractors from **160 to 550 HP**



VF Very High Flexion



SOIL PROTECTION

- **+27%** wider **FOOTPRINT** ⁽¹⁾ to protect soil from **COMPACTION** and improve yields



More **TRACTION** from 2 additional 45 degree lugs ⁽²⁾



PRODUCTIVITY

- Carry up to **40%** more load at the same pressure versus non-VF radial tyre in the same size



Has a **STUBBLE GUARD**

(1) Michelin test 2016, VF 480/80 R50 Yieldbib vs 480/80 R50 AGRIBIB.

(2) Compared to Competitors' standard tyres with 23 lugs.

SIZES

VF 380/85 R34 149A8/149B TL

VF 420/85 R34 154A8/154B TL

VF 380/80 R38 149A8/149B TL

VF 380/95 R38 154A8/154B TL

VF 480/80 R46 164A8/164B TL

VF 480/80 R50 166A8/166B TL

VF 480/95 R50 170A8/170B TL

MICHELIN YELDBIB

Tyre specifications and pressure table (bar & psi). Load per tyre in kg*

Ø inches	Description	CAI	S mm	OD mm	LR mm	RC mm	Recommended Rim		Acceptable Rim		Tube (Code)	75% internal volume (litres)	Tread depth (mm)
34	VF 380/85 R34 149A8/149B TL	305457	372	1510	668	4471	W13	W12	704	230	44		
Bar	0.4 0.5 0.6 0.7 0.8 0.9 1.0 1.1 1.2 1.3 1.4 1.5 1.6												
Psi	6 7 9 10 12 13 15 16 17 19 20 22 23												
10 km/h	1595 1760 1925 2090 2255 2420 2585 2750 2915 3080 3245 3410 3575												
30 km/h	1480 1635 1785 1940 2090 2245 2400 2550 2705 2860 3010 3165 3315												
50 km/h	1450 1600 1750 1900 2050 2200 2350 2500 2650 2800 2950 3100 3250												
30 km/h Dual	1300 1435 1570 1705 1840 1975 2110 2245 2380 2515 2650 2780 2915												
50 km/h Dual	1280 1410 1545 1675 1805 1940 2070 2205 2335 2465 2600 2730 2860												
50 km/h Triple	1190 1315 1435 1560 1680 1805 1930 2050 2175 2300 2420 2545 2665												
30 km/h Triple	1215 1340 1465 1590 1715 1840 1970 2095 2220 2345 2470 2595 2720												

Ø inches	Description	CAI	S mm	OD mm	LR mm	RC mm	Recommended Rim		Acceptable Rim		Tube (Code)	75% internal volume (litres)	Tread depth (mm)
34	VF 420/85 R34 154A8/154B TL	012445	432	1582	699	4682	DW15L	DW14A (L) W14L W15A (L)	704	287	48		
Bar	0.4 0.5 0.6 0.7 0.8 0.9 1.0 1.1 1.2 1.3 1.4 1.5 1.6												
Psi	6 7 9 10 12 13 15 16 17 19 20 22 23												
10 km/h	1870 2060 2250 2440 2630 2820 3010 3195 3385 3570 3755 3940 4125												
30 km/h	1735 1910 2090 2265 2440 2615 2790 2960 3135 3310 3480 3655 3825												
50 km/h	1700 1875 2045 2220 2390 2560 2735 2905 3075 3245 3415 3580 3750												
30 km/h Dual	1525 1680 1835 1990 2145 2300 2455 2605 2760 2910 3065 3215 3365												
50 km/h Dual	1500 1650 1805 1955 2105 2255 2405 2555 2705 2855 3005 3150 3300												
50 km/h Triple	1395 1535 1680 1820 1960 2100 2240 2380 2520 2660 2800 2935 3075												
30 km/h Triple	1425 1570 1715 1855 2000 2145 2285 2430 2570 2710 2855 2995 3135												

Ø inches	Description	CAI	S mm	OD mm	LR mm	RC mm	Recommended Rim		Acceptable Rim		Tube (Code)	75% internal volume (litres)	Tread depth (mm)
38	VF 380/80 R38 149A8/149B TL	870363	366	1592	711	4851	DW12A	W12 W13	796 795	230	45		
Bar	0.4 0.5 0.6 0.7 0.8 0.9 1.0 1.1 1.2 1.3 1.4 1.5 1.6												
Psi	6 7 9 10 12 13 15 16 17 19 20 22 23												
10 km/h	1595 1760 1930 2095 2260 2425 2590 2755 2920 3085 3250 3410 3575												
30 km/h	1480 1635 1790 1940 2095 2250 2405 2555 2710 2860 3015 3165 3315												
50 km/h	1450 1600 1755 1905 2055 2205 2355 2505 2655 2805 2955 3100 3250												
30 km/h Dual	1300 1435 1575 1710 1845 1980 2115 2250 2385 2520 2650 2785 2915												
50 km/h Dual	1280 1415 1550 1680 1815 1945 2080 2210 2340 2470 2600 2730 2860												
50 km/h Triple	1190 1315 1440 1560 1685 1810 1935 2055 2180 2300 2425 2545 2665												
30 km/h Triple	1215 1340 1470 1595 1720 1845 1970 2095 2220 2345 2470 2595 2720												

* Refer to the notes at the end of the tables of this range

MICHELIN YIELDBIB

Tyre specifications and pressure table (bar & psi). Load per tyre in kg*

Ø inches	Description	CAI	S mm	OD mm	LR mm	RC mm	Recommended Rim		Acceptable Rim		Tube (Code)	75% internal volume (litres)	Tread depth (mm)
38	VF 380/95 R38 154A8/154B TL	873023	377	1703	755	5044	DW12A	W12	795	796	286	47	
Bar	0.4	0.5	0.6	0.7	0.8	0.9	1.0	1.1	1.2	1.3	1.4	1.5	1.6
Psi	6	7	9	10	12	13	15	16	17	19	20	22	23
10 km/h	1870	2060	2250	2435	2625	2810	3000	3185	3370	3560	3750	3935	4125
30 km/h	1735	1910	2085	2260	2435	2610	2780	2955	3125	3300	3475	3650	3825
50 km/h	1700	1870	2045	2215	2385	2555	2725	2895	3065	3235	3410	3580	3750
30 km/h Dual	1525	1680	1835	1990	2145	2295	2450	2600	2750	2905	3060	3210	3365
50 km/h Dual	1500	1650	1800	1950	2100	2250	2400	2550	2700	2850	3000	3150	3300
50 km/h Triple	1400	1540	1680	1815	1955	2095	2235	2375	2515	2655	2795	2935	3075
30 km/h Triple	1425	1570	1710	1855	1995	2140	2280	2425	2565	2710	2850	2995	3135

Ø inches	Description	CAI	S mm	OD mm	LR mm	RC mm	Recommended Rim		Acceptable Rim		Tube (Code)	75% internal volume (litres)	Tread depth (mm)
46	VF 480/80 R46 164A8/164B TL	842300	480	1933	861	5732	DW16A	DW15L DW16B DW16L W16A	834	449	52		
Bar	0.4	0.5	0.6	0.7	0.8	0.9	1.0	1.1	1.2	1.3	1.4	1.5	1.6
Psi	6	7	9	10	12	13	15	16	17	19	20	22	23
10 km/h	2530	2780	3025	3275	3520	3770	4015	4265	4510	4760	5005	5255	5500
30 km/h	2345	2575	2805	3035	3265	3495	3725	3950	4180	4410	4640	4870	5100
50 km/h	2300	2525	2750	2975	3200	3425	3650	3875	4100	4325	4550	4775	5000
30 km/h Dual	2065	2270	2470	2675	2875	3075	3280	3480	3680	3885	4085	4290	4490
50 km/h Dual	2025	2225	2420	2620	2815	3015	3215	3410	3610	3810	4005	4205	4400
50 km/h Triple	1885	2070	2255	2440	2625	2810	2995	3175	3360	3545	3730	3915	4100
30 km/h Triple	1925	2115	2300	2490	2675	2865	3055	3240	3430	3620	3805	3995	4180

Ø inches	Description	CAI	S mm	OD mm	LR mm	RC mm	Recommended Rim		Acceptable Rim		Tube (Code)	75% internal volume (litres)	Tread depth (mm)
50	VF 480/80 R50 166A8/166B TL	309830	468	2039	901	6034	DW16A (L)	DW15B(A) W15B (A) DW16B W16B DW15L		479	49		
Bar	0.4	0.5	0.6	0.7	0.8	0.9	1.0	1.1	1.2	1.3	1.4	1.5	1.6
Psi	6	7	9	10	12	13	15	16	17	19	20	22	23
10 km/h	2595	2855	3115	3375	3635	3895	4155	4415	4675	4965	5255	5540	5830
30 km/h	2405	2645	2890	3130	3370	3610	3855	4095	4335	4605	4870	5140	5405
50 km/h	2360	2595	2835	3070	3305	3540	3780	4015	4250	4515	4775	5040	5300
30 km/h Dual	2115	2330	2540	2755	2965	3180	3390	3605	3815	4050	4285	4520	4755
50 km/h Dual	2075	2285	2495	2700	2910	3120	3325	3535	3740	3970	4200	4430	4660
50 km/h Triple	1930	2125	2320	2515	2710	2905	3100	3295	3490	3705	3920	4135	4350
30 km/h Triple	1970	2170	2370	2565	2765	2965	3160	3360	3555	3775	3995	4210	4430

* Refer to the notes at the end of the tables of this range

MICHELIN YIELDBIB

Tyre specifications and pressure table (bar & psi). Load per tyre in kg*

Ø inches	Description	CAI	S mm	OD mm	LR mm	RC mm	Recommended Rim			Acceptable Rim		Tube (Code)	75% internal volume (litres)	Tread depth (mm)
50	VF 480/95 R50 170A8/170B TL	252129	477	2186	962	6661	DW16A (L)			DW15B(A) W15B(A) DW16B W16B DW15L			593	51
Bar	0.4	0.5	0.6	0.7	0.8	0.9	1.0	1.1	1.2	1.3	1.4	1.5	1.6	
Psi	6	7	9	10	12	13	15	16	17	19	20	22	23	
10 km/h	3000	3315	3625	3940	4250	4565	4875	5190	5500	5775	6050	6325	6600	
30 km/h	2780	3070	3360	3650	3940	4230	4520	4810	5100	5355	5610	5865	6120	
50 km/h	2725	3010	3295	3580	3865	4150	4435	4715	5000	5250	5500	5750	6000	
30 km/h Dual	2445	2700	2955	3210	3465	3720	3980	4235	4490	4715	4940	5160	5385	
50 km/h Dual	2400	2650	2900	3150	3400	3650	3900	4150	4400	4620	4840	5060	5280	
50 km/h Triple	2235	2470	2705	2935	3170	3405	3635	3870	4100	4305	4510	4715	4920	
30 km/h Triple	2280	2520	2755	2995	3230	3470	3705	3945	4180	4390	4600	4810	5020	

***IMPORTANT:**

The inflation pressure must always be appropriate for the load per tyre, the speed of travel and the work to be done. Our recommendations above were correct as of the time of publication of these tables (June 2018). Technical data is subject to change without prior notice.

- When using single tyre configuration:
 - add 0.4 bar for use on slopes of more than 20%
 - add 0.4 bar for intense road use exceeding 50%



MICHELIN AGRIBIB 2

**HIGH LEVELS
OF PERFORMANCE
THROUGHOUT ITS LIFE**



For tractors from **60 to 170 HP**
and up to **500HP with dual and triple fitments**
(42", 46", 50")



Optimal TRACTION with 45° lug angle



SERVICE LIFE thanks to deep tread lugs
• Deeper tread than leading competitors⁽¹⁾



ROBUSTNESS
• Up to 18% higher load index⁽²⁾

(1) Analytic test on MICHELIN test tracks Ladoux Centre in Clay/Chalky Soil – Size 18.4 R38

(2) Depending on size & for size 520/85 R46 164A8/164B

SIZES

280/85 R28 123A8/120D TL

380/85 R30 140A8/140B TL

420/90 R30 147A8/147B TL

320/85 R34 133A8/133B TL

380/85 R34 142A8/142B TL

420/85 R34 147A8/147B TL

380/80 R38 142A8/139D TL

420/85 R38 149A8/149B TL **NEW**

520/85 R38 160A8/160B TL

480/80 R42 156A8/156B TL

520/85 R42 162A8/162B TL

420/80 R46 151A8/151B TL

480/80 R46 158A8/158B TL

520/85 R46 164A8/164B TL

480/80 R50 159A8/159B TL

380/90 R54 152A8/152B TL

MICHELIN AGRIBIB 2

Tyre specifications and pressure table (bar & psi). Load per tyre in kg*

Ø inches	Description	CAI	S mm	OD mm	LR mm	RC mm	Recommended Rim	Acceptable Rim	Tube (Code)	75% internal volume (litres)	Tread depth (mm)
28	280/85 R28 123A8/120D TL <i>11, R28</i>	392931	299	1192	545	3563	W10	W9	725	98	40
Bar	0.4 0.6 0.8 1.0 1.2 1.4 1.6 1.8 2.0 2.2 2.4 2.6 2.8										
Psi	6 9 12 15 17 20 23 26 29 32 35 38 41										
10 km/h	900 1075 1245 1420 1590 1680 1770 1905 2040 2110 2185 2255 2325										
30 km/h	640 760 885 1010 1135 1275 1410 1475 1535 1600 1660										
40 km/h	710 825 945 1060 1190 1320 1380 1435 1495 1550										
50 km/h	645 750 860 965 1085 1200 1255 1305 1360 1410										
65 km/h	645 750 860 965 1085 1200 1255 1305 1360 1410										
40 km/h Dual	625 725 830 935 1050 1160 1210 1265 1315 1365										

Ø inches	Description	CAI	S mm	OD mm	LR mm	RC mm	Recommended Rim	Acceptable Rim	Tube (Code)	75% internal volume (litres)	Tread depth (mm)
30	380/85 R30 140A8/140B TL <i>14,9 R30</i>	151572	394	1416	644	4219	W12	W13	734	229	47
Bar	0.4 0.6 0.8 1.0 1.2 1.4 1.6 1.8 2.0 2.2 2.4 2.6 2.8										
Psi	6 9 12 15 17 20 23 26 29 32 35 38 41										
10 km/h	1465 1755 2045 2335 2625 2775 2925 3145 3360 3460 3555 3655 3750										
30 km/h	1045 1265 1455 1665 1875 2105 2335 2420 2505 2590 2675										
40 km/h	1180 1360 1555 1750 1965 2180 2260 2340 2420 2500										
50 km/h	1180 1360 1555 1750 1965 2180 2260 2340 2420 2500										
40 km/h Dual	1040 1195 1370 1540 1730 1920 1990 2060 2130 2200										

Ø inches	Description	CAI	S mm	OD mm	LR mm	RC mm	Recommended Rim	Acceptable Rim	Tube (Code)	75% internal volume (litres)	Tread depth (mm)
30	420/90 R30 147A8/147B TL	508522	418	1518	684	4513	DW13	DW14L W13 W14L	754	284	50
Bar	0.4 0.6 0.8 1.0 1.2 1.4 1.6 1.8 2.0 2.2 2.4 2.6 2.8										
Psi	6 9 12 15 17 20 23 26 29 32 35 38 41										
10 km/h	1825 2120 2420 2715 3015 3310 3605 3905 4200 4305 4410 4510 4615										
30 km/h	1300 1550 1810 2075 2335 2585 2835 2970 3105 3200 3290										
40 km/h	1450 1700 1940 2180 2415 2650 2775 2900 2990 3075										
50 km/h	1450 1700 1940 2180 2415 2650 2775 2900 2990 3075										
40 km/h Dual	1070 1275 1495 1710 1920 2125 2330 2425 2520 2610 2705										

* Refer to the notes at the end of the tables of this range

MICHELIN AGRIBIB 2

Tyre specifications and pressure table (bar & psi). Load per tyre in kg*

Ø inches	Description	CAI	S mm	OD mm	LR mm	RC mm	Recommended Rim		Acceptable Rim		Tube (Code)	75% internal volume (litres)	Tread depth (mm)
34	320/85 R34 133A8/133B TL <i>12.4 R34</i>	908266	312	1421	653	4243	W10					155	44
Bar	0.4	0.6	0.8	1.0	1.2	1.4	1.6	1.8	2.0	2.2	2.4	2.6	2.8
Psi	6	9	12	15	17	20	23	26	29	32	35	38	41
10 km/h	1200	1445	1690	1930	2175	2290	2400	2550	2700	2800	2895	2995	3090
30 km/h	855	1045	1200	1375	1550	1715	1875	1960	2040	2125	2205		
40 km/h		975	1120	1285	1450	1600	1750	1830	1905	1985	2060		
50 km/h		975	1120	1285	1450	1600	1750	1830	1905	1985	2060		
40 km/h Dual	705	860	985	1130	1275	1410	1540	1610	1680	1745	1815		

Ø inches	Description	CAI	S mm	OD mm	LR mm	RC mm	Recommended Rim		Acceptable Rim		Tube (Code)	75% internal volume (litres)	Tread depth (mm)
34	380/85 R34 142A8/142B TL <i>14.9 R34</i>	009860	378	1516	691	4519	W12		W13		704	286	47
Bar	0.4	0.6	0.8	1.0	1.2	1.4	1.6	1.8	2.0	2.2	2.4	2.6	2.8
Psi	6	9	12	15	17	20	23	26	29	32	35	38	41
10 km/h	1545	1855	2160	2470	2775	2935	3090	3315	3540	3650	3760	3865	3975
30 km/h	1100	1340	1550	1765	1980	2220	2460	2555	2650	2740	2835		
40 km/h		1250	1450	1650	1850	2075	2300	2390	2475	2565	2650		
50 km/h		1250	1450	1650	1850	2075	2300	2390	2475	2565	2650		
40 km/h Dual	1100	1275	1455	1630	1830	2025	2100	2180	2255	2330			

Ø inches	Description	CAI	S mm	OD mm	LR mm	RC mm	Recommended Rim		Acceptable Rim		Tube (Code)	75% internal volume (litres)	Tread depth (mm)
34	420/85 R34 147A8/147B TL <i>16.9 R34</i>	183733	449	1589	720	4730	DW15L		DW14L W13 W14L W15L		704	287	49
Bar	0.4	0.6	0.8	1.0	1.2	1.4	1.6	1.8	2.0	2.2	2.4	2.6	2.8
Psi	6	9	12	15	17	20	23	26	29	32	35	38	41
10 km/h	1825	1795	2285	2780	3270	3460	3645	3870	4090	4220	4355	4485	4615
30 km/h	1300	1550	1820	2080	2335	2585	2835	2950	3065	3175	3290		
40 km/h		1450	1700	1940	2180	2415	2650	2755	2865	2970	3075		
50 km/h		1450	1700	1940	2180	2415	2650	2755	2865	2970	3075		
40 km/h Dual	1070	1275	1495	1710	1920	2125	2330	2425	2520	2610	2705		

* Refer to the notes at the end of the tables of this range

MICHELIN AGRIBIB 2

Tyre specifications and pressure table (bar & psi). Load per tyre in kg*

Ø inches	Description	CAI	S mm	OD mm	LR mm	RC mm	Recommended Rim	Acceptable Rim	Tube (Code)	75% internal volume (litres)	Tread depth (mm)		
38	380/80 R38 142A8/139D TL	187095	380	1595	729	4755	DW12A	DW12 DW13 W12 W13	796 795	230	46		
Bar	0.4	0.6	0.8	1.0	1.2	1.4	1.6	1.8	2.0	2.2	2.4	2.6	2.8
Psi	6	9	12	15	17	20	23	26	29	32	35	38	41
10 km/h	1545	1870	2200	2525	2850	2970	3090	3315	3540	3650	3760	3865	3975
30 km/h	1100	1340	1550	1795	2035	2250	2460	2555	2650	2740	2835		
40 km/h		1250	1450	1675	1900	2100	2300	2390	2475	2565	2650		
50 km/h		1250	1450	1675	1900	2100	2300	2390	2475	2565	2650		
65 km/h		1140	1320	1525	1730	1915	2095	2175	2255	2330	2410		
40 km/h Dual		1100	1275	1475	1670	1850	2025	2100	2180	2255	2330		

Ø inches	Description	CAI	S mm	OD mm	LR mm	RC mm	Recommended Rim	Acceptable Rim	Tube (Code)	75% internal volume (litres)	Tread depth (mm)		
38	420/85 R38 149A8/149B TL NEW <i>16.9 R38</i>	048439	450	1690	769	5035	DW15L	DW14L W14L W15L	786	293	49		
Bar	0.4	0.6	0.8	1.0	1.2	1.4	1.6	1.8	2.0	2.2	2.4	2.6	2.8
Psi	6	9	12	15	17	20	23	26	29	32	35	38	41
10 km/h	1930	2250	2575	2895	3215	3535	3860	4180	4500	4595	4690	4780	4875
30 km/h	1375	1660	1925	2195	2460	2730	2995	3145	3290	3385	3480		
40 km/h		1550	1800	2050	2300	2550	2800	2940	3075	3165	3250		
50 km/h		1550	1800	2050	2300	2550	2800	2940	3075	3165	3250		
40 km/h Dual		1130	1365	1585	1805	2025	2245	2465	2565	2665	2760	2860	

Ø inches	Description	CAI	S mm	OD mm	LR mm	RC mm	Recommended Rim	Acceptable Rim	Tube (Code)	75% internal volume (litres)	Tread depth (mm)		
38	520/85 R38 160A8/160B TL <i>20.8 R38</i>	882358	533	1849	831	5493	DW16L	DD16 DD18 DW18L W16A W18A	825	508	55		
Bar	0.4	0.6	0.8	1.0	1.2	1.4	1.6	1.8	2.0	2.2	2.4	2.6	2.8
Psi	6	9	12	15	17	20	23	26	29	32	35	38	41
10 km/h	2625	3070	3515	3960	4410	4855	5300	5745	6190	6330	6470	6610	6750
30 km/h	1875	2270	2635	3005	3370	3760	4145	4350	4550	4685	4815		
40 km/h		2120	2500	2825	3150	3515	3875	4065	4250	4375	4500		
50 km/h		2120	2500	2825	3150	3515	3875	4065	4250	4375	4500		
40 km/h Dual		1540	1865	2200	2485	2770	3090	3410	3550	3685	3825	3960	

* Refer to the notes at the end of the tables of this range

MICHELIN AGRIBIB 2

Tyre specifications and pressure table (bar & psi). Load per tyre in kg*

Ø inches	Description	CAI	S mm	OD mm	LR mm	RC mm	Recommended Rim	Acceptable Rim	Tube (Code)	75% internal volume (litres)	Tread depth (mm)
42	480/80 R42 156A8/156B TL <i>18.4 R42</i>	539386	489	1840	837	5470	DW16A	DD16W16A	831	412	52
Bar	0.4 0.6 0.8 1.0 1.2 1.4 1.6 1.8 2.0 2.2 2.4 2.6 2.8										
Psi	6 9 12 15 17 20 23 26 29 32 35 38 41										
10 km/h	2325 2720 3115 3505 3900 4295 4690 5080 5475 5605 5740 5870 6000										
30 km/h	1660 1980 2320 2655 2995 3345 3690 3855 4015 4150 4280										
40 km/h	1850 2180 2490 2800 3125 3450 3600 3750 3875 4000										
50 km/h	1850 2180 2490 2800 3125 3450 3600 3750 3875 4000										
40 km/h Dual	1365 1630 1920 2195 2465 2750 3035 3155 3280 3400 3520										

Ø inches	Description	CAI	S mm	OD mm	LR mm	RC mm	Recommended Rim	Acceptable Rim	Tube (Code)	75% internal volume (litres)	Tread depth (mm)
42	520/85 R42 162A8/162B TL <i>20.8 R42</i>	405859	542	1958	886	5810	DW18A	DD18W18A	802	545	55
Bar	0.4 0.6 0.8 1.0 1.2 1.4 1.6 1.8 2.0 2.2 2.4 2.6 2.8										
Psi	6 9 12 15 17 20 23 26 29 32 35 38 41										
10 km/h	2775 3250 3725 4195 4670 5145 5620 6090 6565 6705 6845 6985 7125										
30 km/h	1980 2395 2790 3190 3585 4000 4415 4615 4815 4950 5085										
40 km/h	2240 2575 2965 3350 3740 4125 4315 4500 4625 4750										
50 km/h	2240 2575 2965 3350 3740 4125 4315 4500 4625 4750										
40 km/h Dual	1630 1970 2265 2610 2950 3290 3630 3770 3905 4045 4180										

Ø inches	Description	CAI	S mm	OD mm	LR mm	RC mm	Recommended Rim	Acceptable Rim	Tube (Code)	75% internal volume (litres)	Tread depth (mm)
46	420/80 R46 151A8/151B TL	885138	410	1854	844	5524	DW13	DW12	835	334	50
Bar	0.4 0.6 0.8 1.0 1.2 1.4 1.6 1.8 2.0 2.2 2.4 2.6 2.8										
Psi	6 9 12 15 17 20 23 26 29 32 35 38 41										
10 km/h	1980 2395 2815 3230 3645 3810 3975 4240 4500 4670 4840 5005 5175										
30 km/h	1410 1710 1980 2290 2600 2855 3105 3250 3400 3545 3690										
40 km/h	1600 1850 2140 2430 2665 2900 3040 3175 3315 3450										
50 km/h	1600 1850 2140 2430 2665 2900 3040 3175 3315 3450										
40 km/h Dual	1160 1410 1630 1885 2140 2345 2550 2670 2795 2915 3035										

Ø inches	Description	CAI	S mm	OD mm	LR mm	RC mm	Recommended Rim	Acceptable Rim	Tube (Code)	75% internal volume (litres)	Tread depth (mm)
46	480/80 R46 158A8/158B TL <i>18.4 R46</i>	622709	486	1945	891	5804	DW16A	DD16 DW16L W16A	834	449	52
Bar	0.4 0.6 0.8 1.0 1.2 1.4 1.6 1.8 2.0 2.2 2.4 2.6 2.8										
Psi	6 9 12 15 17 20 23 26 29 32 35 38 41										
10 km/h	2475 2945 3415 3880 4350 4615 4875 5175 5475 5700 5925 6150 6375										
30 km/h	1765 2085 2460 2785 3105 3455 3800 3990 4175 4365 4550										
40 km/h	1950 2300 2600 2900 3225 3550 3725 3900 4075 4250										
50 km/h	1950 2300 2600 2900 3225 3550 3725 3900 4075 4250										
40 km/h Dual	1715 2025 2290 2550 2840 3125 3280 3435 3585 3740										

* Refer to the notes at the end of the tables of this range

MICHELIN AGRIBIB 2

Tyre specifications and pressure table (bar & psi). Load per tyre in kg*

Ø inches	Description	CAI	S mm	OD mm	LR mm	RC mm	Recommended Rim		Acceptable Rim	Tube (Code)	75% internal volume (litres)	Tread depth (mm)
46	520/85 R46 164A8/164B TL	120922	518	2059	931	6110	DW16A		DW16L DW18A	834	560	55
	DW18L W16A W16L W18A W18L											
Bar	0.4 0.6 0.8 1.0 1.2 1.4 1.6 1.8 2.0	1.0 1.2 1.4 1.6 1.8 2.0	2.2 2.4	2.6 2.8								
Psi	6 9 12 15 17 20 23 26 29	32 35	38 41									
10 km/h	2925 3425 3930 4430 4935 5435 5935 6440 6940	7035 7130	7220 7315									
30 km/h	2085 2460 2870 3280 3690 4120 4550 4750 4950	5150 5350										
40 km/h	2300 2725 3090 3450 3850 4250 4440 4625	4815 5000										
50 km/h	2300 2725 3090 3450 3850 4250 4440 4625	4815 5000										
40 km/h Dual	1715 2025 2400 2720 3035 3390 3740 3905 4070	4235 4400										

Ø inches	Description	CAI	S mm	OD mm	LR mm	RC mm	Recommended Rim		Acceptable Rim	Tube (Code)	75% internal volume (litres)	Tread depth (mm)
50	480/80 R50 159A8/159B TL	263049	465	2050	938	6116	DW15A		DW16A		483	52
	DW18A											
Bar	0.4 0.6 0.8 1.0 1.2 1.4 1.6 1.8 2.0	1.0 1.2 1.4 1.6 1.8 2.0	2.2 2.4	2.6 2.8								
Psi	6 9 12 15 17 20 23 26 29	32 35	38 41									
10 km/h	2550 3065 3585 4100 4615 4895 5175 5495 5815	6005 6190	6380 6565									
30 km/h	1820 2205 2525 2910 3290 3655 4015 4180 4350	4515 4680										
40 km/h	2060 2360 2720 3075 3415 3750 3905 4065	4220 4375										
50 km/h	2060 2360 2720 3075 3415 3750 3905 4065	4220 4375										
40 km/h Dual	1815 2075 2390 2705 3005 3300 3440 3575	3715 3850										

Ø inches	Description	CAI	S mm	OD mm	LR mm	RC mm	Recommended Rim		Acceptable Rim	Tube (Code)	75% internal volume (litres)	Tread depth (mm)
54	380/90 R54 152A8/152B TL	075615	386	2054	949	6129	W12A		DW13B		334	50
	DW14B											
Bar	0.4 0.6 0.8 1.0 1.2 1.4 1.6 1.8 2.0	1.0 1.2 1.4 1.6 1.8 2.0	2.2 2.4	2.6 2.8								
Psi	6 9 12 15 17 20 23 26 29	32 35	38 41									
10 km/h	2040 2470 2895 3325 3750 3920 4090 4410 4725	4875 5025	5175 5325									
30 km/h	1455 1765 2085 2380 2675 2945 3210 3360 3505	3655 3805										
40 km/h	1650 1950 2225 2500 2750 3000 3140 3275	3415 3550										
50 km/h	1650 1950 2225 2500 2750 3000 3140 3275	3415 3550										
40 km/h Dual	1450 1715 1960 2200 2420 2640 2760 2885	3005 3125										

***IMPORTANT:**

The inflation pressure must always be appropriate for the load per tyre, the speed of travel and the work to be done. Our recommendations above were correct as of the time of publication of these tables (June 2018). Technical data is subject to change without prior notice.

- For ploughing and other field applications subject to high torque, use the 30 km/h column.
- When using single tyre configuration:
 - add 0.4 bar for use on slopes of more than 20%
 - add 0.4 bar for intense road use exceeding 50%
- **10 km/h LT (Low Torque) (max speed 10 km/h).

TRACTORS

LOW & MEDIUM POWER



MICHELIN AGRIBIB

**HIGH PERFORMANCE
WITH OPTIMAL TRACTION**



For tractors from 60 to 170 HP

and up to 500HP with dual and triple fitments (42", 46", 50")



OPTIMAL TRACTION:

- Maintains traction throughout its life, even when worn



EXCELLENT SERVICE LIFE thanks to deep tread lugs



ROBUSTNESS:

- Proven radial casing endurance
- Damage-resistant rubber

SIZES

9.5 R24 112A8/109B TL

16.9 R28 141A8/138B TL

12.4 R36 124A8/121B TL

520/85 R42 157A8/157B TL

11.2 R24 119A8/116B TL

380/85 R30 135A8/135B TL

12.4 R38 131A8/128B TL

420/80 R46 151A8/148B TL

12.4 R24 119A8/116B TL

16.9 R30 137A8/134B TL

13.6 R38 128A8/125B TL

480/80 R46 158A8/158B TL

13.6 R24 124A8/121B TL

420/90 R30 147A8/147B TL

420/85 R38 144A8/144B TL

520/85 R46 158A8/155B TL

14.9 R24 130A8/127B TL

18.4 R30 142A8/139B TL

380/95 R38 147A8/147B TL

480/80 R50 159A8/159B TL

16.9 R24 134A8/131B TL

320/85 R34 133A8/130B TL

18.4 R38 151A8/148B TL

480/95 R50 164A8/164B TL

12.4 R28 126A8/123B TL

380/85 R34 137A8/137B TL

20.8 R38 159A8/156B TL

13.6 R28 123A8/120B TL

420/85 R34 147A8/147B TL

520/85 R38 155A8/155B TL

14.9 R28 134A8/131B TL

18.4 R34 149A8/146B TL

480/80 R42 156A8/156B TL

MICHELIN AGRIBIB

Tyre specifications and pressure table (bar & psi). Load per tyre in kg*

Ø inches	Description	CAI	S mm	OD mm	LR mm	RC mm	Recommended Rim	Acceptable Rim	Tube (Code)	75% internal volume (litres)	Tread depth (mm)				
24	9.5 R24 112A8/109B TL	200987	253	1045	481	3117	W8	W7	686	65	32				
Bar	0.4	0.5	0.6	0.8	1.0	1.2	1.4	1.6	1.8	2.0	2.1	2.3	2.4	2.6	2.8
Psi	6	7	9	12	15	17	20	23	26	29	30	33	35	38	41
10 km/h	675	745	815	960	1100	1240	1280	1315	1395	1475	1515	1595	1635		
30 km/h	535	605	675	745	815	885	965	1045	1105	1170	1200				
40 km/h			630	695	760	825	900	975	1035	1090	1120				
50 km/h			575	640	710	775	830	885	940	995	1020				
40 km/h Dual	385	470	555	615	675	740	800	860	910	960	985				

Ø inches	Description	CAI	S mm	OD mm	LR mm	RC mm	Recommended Rim	Acceptable Rim	Tube (Code)	75% internal volume (litres)	Tread depth (mm)				
24	11.2 R24 119A8/116B TL	317247	288	1095	503	3269	W10	W9	692	92	37				
Bar	0.4	0.5	0.6	0.8	1.0	1.2	1.4	1.6	1.8	2.0	2.1	2.3	2.4	2.6	2.8
Psi	6	7	9	12	15	17	20	23	26	29	30	33	35	38	41
10 km/h	840	925	1005	1170	1335	1500	1570	1635	1720	1810	1850	1935	1980		
30 km/h	660	745	830	910	990	1070	1170	1265	1340	1415	1455				
40 km/h			775	850	925	1000	1090	1180	1250	1325	1360				
50 km/h			705	780	860	935	1005	1075	1140	1205	1240				
40 km/h Dual	480	580	680	750	825	895	970	1040	1100	1165	1195				

Ø inches	Description	CAI	S mm	OD mm	LR mm	RC mm	Recommended Rim	Acceptable Rim	Tube (Code)	75% internal volume (litres)	Tread depth (mm)				
24	12.4 R24 119A8/116B TL	123788	324	1149	520	3420	W11	W10	692	116	41				
Bar	0.4	0.5	0.6	0.8	1.0	1.2	1.4	1.6	1.8	2.0	2.1	2.3	2.4	2.6	2.8
Psi	6	7	9	12	15	17	20	23	26	29	30	33	35	38	41
10 km/h		1040	1200	1330	1460	1590	1715	1845	1975						
30 km/h		810	950	1050	1155	1255	1360	1460							
40 km/h			880	975	1070	1170	1265	1360							
50 km/h			830	915	1000	1080	1165	1250							

* Refer to the notes at the end of the tables of this range

MICHELIN AGRIBIB

Tyre specifications and pressure table (bar & psi). Load per tyre in kg*

Ø inches	Description	CAI	S mm	OD mm	LR mm	RC mm	Recommended Rim	Acceptable Rim	Tube (Code)	75% internal volume (litres)	Tread depth (mm)				
24	13.6 R24 124A8/121B TL	262831	370	1200	551	3583	W12	W11	700	144	43				
Bar	0.4	0.5	0.6	0.8	1.0	1.2	1.4	1.6	1.8	2.0	2.1	2.3	2.4	2.6	2.8
Psi	6	7	9	12	15	17	20	23	26	29	30	33	35	38	41
5 km/h	1105	1215	1320	1505	1690	1875	2060	2245	2365	2485	2540	2660	2720		
10 km/h	975	1075	1175	1375	1570	1770	1850	1930	2030	2130	2175	2275	2325		
15 km/h	870	955	1040	1220	1400	1580	1705	1830	1955	2080	2145				
30 km/h	760	865	965	1065	1165	1265	1385	1500	1585	1670	1710				
40 km/h			900	995	1085	1180	1290	1400	1480	1560	1600				
50 km/h			820	915	1010	1105	1190	1275	1345	1420	1455				
40 km/h Dual	555	675	790	880	965	1055	1140	1230	1300	1375	1410				
40 km/h FRT								1550	1680	1775	1825	1920	1960	2040	

Ø inches	Description	CAI	S mm	OD mm	LR mm	RC mm	Recommended Rim	Acceptable Rim	Tube (Code)	75% internal volume (litres)	Tread depth (mm)				
24	14.9 R24 130A8/127B TL	601563	397	1265	575	3769	W13	W11 W12	703	188	48				
Bar	0.4	0.5	0.6	0.8	1.0	1.2	1.4	1.6	1.8	2.0	2.1	2.3	2.4	2.6	2.8
Psi	6	7	9	12	15	17	20	23	26	29	30	33	35	38	41
10 km/h	1165	1280	1400	1635	1865	2100	2175	2250	2380	2515	2580	2710	2775		
30 km/h	910	1040	1165	1275	1390	1500	1635	1765	1875	1980	2035				
40 km/h			1090	1195	1295	1400	1525	1650	1750	1850	1900				
50 km/h			990	1100	1210	1320	1410	1500	1590	1685	1730				
40 km/h Dual	660	810	960	1060	1155	1255	1350	1450	1540	1625	1670				

Ø inches	Description	CAI	S mm	OD mm	LR mm	RC mm	Recommended Rim	Acceptable Rim	Tube (Code)	75% internal volume (litres)	Tread depth (mm)				
24	16.9 R24 134A8/131B TL	123854	460	1330	586	3935	DW15L	DW14L W14L W15L	710	244	55				
Bar	0.4	0.5	0.6	0.8	1.0	1.2	1.4	1.6	1.8	2.0	2.1	2.3	2.4	2.6	2.8
Psi	6	7	9	12	15	17	20	23	26	29	30	33	35	38	41
10 km/h		1620	1880	2080	2280	2480	2680	2880	3080						
30 km/h		1270	1470	1630	1790	1950	2110	2270							
40 km/h			1380	1530	1675	1825	1970	2120							
50 km/h			1290	1420	1555	1685	1820	1950							
40 km/h Dual	790	1005	1215	1345	1475	1605	1735	1865							

* Refer to the notes at the end of the tables of this range

MICHELIN AGRIBIB

Tyre specifications and pressure table (bar & psi). Load per tyre in kg*

Ø inches	Description	CAI	S mm	OD mm	LR mm	RC mm	Recommended Rim		Acceptable Rim		Tube (Code)	75% internal volume (litres)	Tread depth (mm)		
28	12.4 R28 126A8/123B TL	738964	322	1265	586	3778	W11		W10		726	134	40		
Bar	0.4	0.5	0.6	0.8	1.0	1.2	1.4	1.6	1.8	2.0	2.1	2.3	2.4	2.6	2.8
Psi	6	7	9	12	15	17	20	23	26	29	30	33	35	38	41
10 km/h	1035	1140	1245	1455	1665	1875	1960	2040	2150	2260	2310	2420	2475		
30 km/h	805	925	1045	1145	1240	1340	1475	1605	1690	1775	1820				
40 km/h			975	1065	1160	1250	1375	1500	1580	1660	1700				
50 km/h			885	980	1075	1170	1270	1365	1435	1510	1545				
40 km/h Dual	590	725	860	950	1045	1135	1230	1320	1390	1460	1495				

Ø inches	Description	CAI	S mm	OD mm	LR mm	RC mm	Recommended Rim		Acceptable Rim		Tube (Code)	75% internal volume (litres)	Tread depth (mm)		
28	13.6 R28 123A8/120B TL	123782	372	1308	592	3893	W12		W11		732	173	46		
Bar	0.4	0.5	0.6	0.8	1.0	1.2	1.4	1.6	1.8	2.0	2.1	2.3	2.4	2.6	2.8
Psi	6	7	9	12	15	17	20	23	26	29	30	33	35	38	41
10 km/h			1190	1370	1520	1665	1815	1960	2110	2255					
30 km/h			930	1080	1195	1310	1430	1545	1660						
40 km/h			1010	1120	1225	1335	1440	1550							
50 km/h			920	1015	1110	1210	1305	1400							
40 km/h Dual	590	740	890	985	1080	1175	1270	1365							

Ø inches	Description	CAI	S mm	OD mm	LR mm	RC mm	Recommended Rim		Acceptable Rim		Tube (Code)	75% internal volume (litres)	Tread depth (mm)		
28	14.9 R28 134A8/131B TL	112235	393	1365	624	4072	W13		W12		821	210	47		
Bar	0.4	0.5	0.6	0.8	1.0	1.2	1.4	1.6	1.8	2.0	2.1	2.3	2.4	2.6	2.8
Psi	6	7	9	12	15	17	20	23	26	29	30	33	35	38	41
10 km/h	1240	1365	1495	1745	2000	2250	2365	2475	2625	2775	2825	2925	2980	3080	3180
30 km/h	885	980	1070	1230	1420	1605	1765	1925	2010	2100	2140	2225	2270		
40 km/h			1000	1150	1325	1500	1650	1800	1880	1960	2000	2080	2120		
50 km/h			910	1045	1205	1365	1505	1640	1715	1785	1820	1895	1930		

Ø inches	Description	CAI	S mm	OD mm	LR mm	RC mm	Recommended Rim		Acceptable Rim		Tube (Code)	75% internal volume (litres)	Tread depth (mm)		
28	16.9 R28 141A8/138B TL	984997	454	1435	655	4278	DW15L		DW14L W14L W15L		822	272	51		
Bar	0.4	0.5	0.6	0.8	1.0	1.2	1.4	1.6	1.8	2.0	2.1	2.3	2.4	2.6	2.8
Psi	6	7	9	12	15	17	20	23	26	29	30	33	35	38	41
10 km/h	1500	1650	1800	2100	2400	2700	2850	3000	3180	3360	3425	3550	3615	3740	3865
30 km/h	1070	1185	1300	1500	1715	1925	2130	2335	2440	2545	2600	2705	2755		
40 km/h			1215	1400	1600	1800	1990	2180	2280	2380	2425	2525	2575		
50 km/h			1105	1275	1460	1640	1815	1985	2075	2165	2210	2300	2345		

* Refer to the notes at the end of the tables of this range

MICHELIN AGRIBIB

Tyre specifications and pressure table (bar & psi). Load per tyre in kg*

Ø inches	Description	CAI	S mm	OD mm	LR mm	RC mm	Recommended Rim		Acceptable Rim		Tube (Code)	75% internal volume (litres)	Tread depth (mm)		
30	380/85 R30 135A8/135B TL (14.9 R30)	836509	386	1416	628	4194	W12	W13	W13	W13		209	46		
Bar	0.4	0.5	0.6	0.8	1.0	1.2	1.4	1.6	1.8	2.0	2.1	2.3	2.4	2.6	2.8
Psi	6	7	9	12	15	17	20	23	26	29	30	33	35	38	41
10 km/h	1450	1565	1680	1905	2135	2360	2580	2800	3100						
30 km/h	1060	1155	1250	1450	1675	1900	2100	2300							
40 km/h			1180	1360	1555	1750	1965	2180							
50 km/h			1180	1360	1550	1750	1965	2180							
40 km/h Dual	860	950	1040	1195	1370	1540	1730	1920							

Ø inches	Description	CAI	S mm	OD mm	LR mm	RC mm	Recommended Rim		Acceptable Rim		Tube (Code)	75% internal volume (litres)	Tread depth (mm)		
30	16.9 R30 137A8/134B TL	123870	447	1480	664	4395	DW15L	DW14L W14L W15L	DW14L W14L W15L	DW14L W14L W15L	754	285	49		
Bar	0.4	0.5	0.6	0.8	1.0	1.2	1.4	1.6	1.8	2.0	2.1	2.3	2.4	2.6	2.8
Psi	6	7	9	12	15	17	20	23	26	29	30	33	35	38	41
10 km/h		1760	2040	2255	2475	2690	2910	3125	3340						
30 km/h		1380	1600	1770	1945	2115	2290	2460							
40 km/h			1500	1660	1820	1980	2140	2300							
50 km/h			1400	1545	1690	1830	1975	2120							
40 km/h Dual	880	1100	1320	1460	1600	1745	1885	2025							

Ø inches	Description	CAI	S mm	OD mm	LR mm	RC mm	Recommended Rim		Acceptable Rim		Tube (Code)	75% internal volume (litres)	Tread depth (mm)		
30	420/90 R30 147A8/147B TL	953332	443	1533	690	4556	DW13	DW14L W13 W14L	DW14L W13 W14L	DW14L W13 W14L	754	284	44		
Bar	0.4	0.5	0.6	0.8	1.0	1.2	1.4	1.6	1.8	2.0	2.1	2.3	2.4	2.6	2.8
Psi	6	7	9	12	15	17	20	23	26	29	30	33	35	38	41
10 km/h	1800	1955	2110	2415	2725	3035	3340	3650	3950	4250	4315	4440	4500	4565	4625
30 km/h	1285	1420	1550	1800	2050	2300	2550	2800	2940	3075	3145	3280	3350		
40 km/h			1450	1700	1940	2175	2415	2650	2775	2900	2945	3030	3075		
50 km/h			1450	1700	1940	2175	2415	2650	2775	2900	2945	3030	3075		
40 km/h Dual	1070	1175	1275	1495	1705	1915	2120	2330	2440	2550	2590	2665	2705		

Ø inches	Description	CAI	S mm	OD mm	LR mm	RC mm	Recommended Rim		Acceptable Rim		Tube (Code)	75% internal volume (litres)	Tread depth (mm)		
30	18.4 R30 142A8/139B TL	123844	504	1550	695	4602	DW16L	DW15L W15L W16L	DW15L W15L W16L	DW15L W15L W16L	757	353	54		
Bar	0.4	0.5	0.6	0.8	1.0	1.2	1.4	1.6	1.8	2.0	2.1	2.3	2.4	2.6	2.8
Psi	6	7	9	12	15	17	20	23	26	29	30	33	35	38	41
10 km/h		2030	2350	2600	2850	3100	3355	3605	3855						
30 km/h		1590	1840	2040	2240	2440	2640	2840							
40 km/h			1720	1905	2090	2280	2465	2650							
50 km/h			1600	1765	1930	2100	2265	2430							
40 km/h Dual	1040	1280	1515	1680	1840	2005	2165	2330							

* Refer to the notes at the end of the tables of this range

MICHELIN AGRIBIB

Tyre specifications and pressure table (bar & psi). Load per tyre in kg*

Ø inches	Description	CAI	S mm	OD mm	LR mm	RC mm	Recommended Rim		Acceptable Rim		Tube (Code)	75% internal volume (litres)	Tread depth (mm)		
34	320/85 R34 133A8/130B TL (12.4 R34)	122760	320	1420	651	4239	W10					155	39		
Bar	0.4	0.5	0.6	0.8	1.0	1.2	1.4	1.6	1.8	2.0	2.1	2.3	2.4	2.6	2.8
Psi	6	7	9	12	15	17	20	23	26	29	30	33	35	38	41
10 km/h	1215	1315	1410	1610	1805	2000	2215	2430	2615	2800	2835	2905	2940	3005	3075
30 km/h	850	940	1030	1215	1385	1550	1725	1900	1980	2060	2090	2150	2180		
40 km/h			975	1120	1285	1450	1600	1750	1850	1950	1980	2035	2060		
50 km/h			900	1030	1180	1320	1460	1600	1700	1800	1825	1875	1900		
40 km/h Dual	705	785	860	985	1130	1275	1410	1540	1630	1715	1740	1790	1815		

Ø inches	Description	CAI	S mm	OD mm	LR mm	RC mm	Recommended Rim		Acceptable Rim		Tube (Code)	75% internal volume (litres)	Tread depth (mm)		
34	380/85 R34 137A8/137B TL (14.9 R34)	122781	394	1503	673	4461	W12		W13		704	230	44		
Bar	0.4	0.5	0.6	0.8	1.0	1.2	1.4	1.6	1.8	2.0	2.1	2.3	2.4	2.6	2.8
Psi	6	7	9	12	15	17	20	23	26	29	30	33	35	38	41
10 km/h	1550	1670	1790	2025	2265	2500	2750	3000	3300						
30 km/h	1120	1220	1320	1550	1775	2000	2215	2430							
40 km/h			1250	1450	1650	1850	2075	2300							
50 km/h			1250	1450	1650	1850	2075	2300							
40 km/h Dual	905	1005	1100	1275	1455	1630	1830	2025							

Ø inches	Description	CAI	S mm	OD mm	LR mm	RC mm	Recommended Rim		Acceptable Rim		Tube (Code)	75% internal volume (litres)	Tread depth (mm)		
34	420/85 R34 147A8/147B TL (16.9 R34)	788910	455	1595	725	4751	DW15L		DW14L W13 W14L W15L		704	287	51		
Bar	0.4	0.5	0.6	0.8	1.0	1.2	1.4	1.6	1.8	2.0	2.1	2.3	2.4	2.6	2.8
Psi	6	7	9	12	15	17	20	23	26	29	30	33	35	38	41
10 km/h	1800	1940	2075	2350	2625	2900	3175	3450	3800	4045	4115	4260	4330	4475	4615
30 km/h	1300	1430	1560	1815	2075	2330	2585	2835	2950	3065	3120	3235	3290		
40 km/h			1450	1695	1935	2180	2415	2650	2755	2865	2915	3020	3075		
50 km/h			1450	1695	1935	2180	2415	2650	2755	2865	2915	3020	3075		
40 km/h Dual			1280	1495	1705	1920	2125	2330	2425	2520	2570	2665	2710		

Ø inches	Description	CAI	S mm	OD mm	LR mm	RC mm	Recommended Rim		Acceptable Rim		Tube (Code)	75% internal volume (litres)	Tread depth (mm)		
34	18.4 R34 149A8/146B TL	679786	491	1662	830	4940	DW16L		DW15L W15L W16L		823	395	54		
Bar	0.4	0.5	0.6	0.8	1.0	1.2	1.4	1.6	1.8	2.0	2.1	2.3	2.4	2.6	2.8
Psi	6	7	9	12	15	17	20	23	26	29	30	33	35	38	41
10 km/h	1980	2175	2370	2760	3150	3540	3705	3865	4080	4295	4405	4620	4725		
30 km/h	1550	1765	1980	2160	2345	2525	2760	2995	3190	3385	3480	3585			
40 km/h			1850	2020	2190	2360	2580	2800	2980	3160	3250				
50 km/h			1685	1860	2035	2210	2380	2550	2715	2880	2960				
40 km/h Dual	1130	1380	1630	1795	1965	2130	2300	2465	2625	2780	2860				

* Refer to the notes at the end of the tables of this range

MICHELIN AGRIBIB

Tyre specifications and pressure table (bar & psi). Load per tyre in kg*

Ø inches	Description	CAI	S mm	OD mm	LR mm	RC mm	Recommended Rim		Acceptable Rim		Tube (Code)	75% internal volume (litres)	Tread depth (mm)		
36	12.4 R36 124A8/121B TL	123952	318	1460	673	4363	W11		W10		779	165	33		
Bar	0.4	0.5	0.6	0.8	1.0	1.2	1.4	1.6	1.8	2.0	2.1	2.3	2.4	2.6	2.8
Psi	6	7	9	12	15	17	20	23	26	29	30	33	35	38	41
10 km/h		1220	1420	1570	1720	1870	2025	2175	2325						
30 km/h		960	1110	1230	1350	1470	1590	1710							
40 km/h			1040	1150	1265	1375	1490	1600							
50 km/h			960	1060	1155	1255	1350	1450							

Ø inches	Description	CAI	S mm	OD mm	LR mm	RC mm	Recommended Rim		Acceptable Rim		Tube (Code)	75% internal volume (litres)	Tread depth (mm)		
38	12.4 R38 131A8/128B TL	258138	325	1500	697	4484	W11		DW10 W10		779	165	35		
Bar	0.4	0.5	0.6	0.8	1.0	1.2	1.4	1.6	1.8	2.0	2.1	2.3	2.4	2.6	2.8
Psi	6	7	9	12	15	17	20	23	26	29	30	33	35	38	41
10 km/h	1200	1315	1425	1650	1875	2100	2215	2325	2440	2550	2605	2720	2775		
30 km/h	935	1070	1200	1300	1400	1500	1660	1820	1925	2030	2085				
40 km/h			1120	1215	1305	1400	1550	1700	1800	1900	1950				
50 km/h			1020	1120	1220	1320	1435	1545	1635	1730	1775				
40 km/h Dual	680	835	985	1085	1190	1290	1395	1495	1585	1670	1715				

Ø inches	Description	CAI	S mm	OD mm	LR mm	RC mm	Recommended Rim		Acceptable Rim		Tube (Code)	75% internal volume (litres)	Tread depth (mm)		
38	13.6 R38 128A8/125B TL	123992	358	1565	722	4705	DW12		W11 W12		795	218	45		
Bar	0.4	0.5	0.6	0.8	1.0	1.2	1.4	1.6	1.8	2.0	2.1	2.3	2.4	2.6	2.8
Psi	6	7	9	12	15	17	20	23	26	29	30	33	35	38	41
10 km/h		1380	1590	1760	1930	2100	2275	2445	2615						
30 km/h		1080	1250	1385	1520	1660	1795	1930							
40 km/h			1170	1140	1250	1365	1475	1800							
50 km/h			1090	1200	1315	1425	1540	1650							
40 km/h Dual	685	860	1030	1140	1250	1365	1475	1585							

Ø inches	Description	CAI	S mm	OD mm	LR mm	RC mm	Recommended Rim		Acceptable Rim		Tube (Code)	75% internal volume (litres)	Tread depth (mm)		
38	420/85 R38 144A8/144B TL (16.9 R38)	607820	455	1676	750	4975	DW15L		DW14L W14L W15L		786	311	51		
Bar	0.4	0.5	0.6	0.8	1.0	1.2	1.4	1.6	1.8	2.0	2.1	2.3	2.4	2.6	2.8
Psi	6	7	9	12	15	17	20	23	26	29	30	33	35	38	41
10 km/h	1900	2045	2190	2485	2775	3065	3360	3650	4015						
30 km/h	1375	1510	1645	1915	2190	2460	2730	3000							
40 km/h			1550	1800	2050	2300	2550	2800							
50 km/h			1550	1800	2050	2300	2550	2800							
40 km/h Dual	1130	1240	1355	1575	1800	2020	2245	2465							
max 40 km/h FRT				2160	2460	2760	3060	3360							

* Refer to the notes at the end of the tables of this range

MICHELIN AGRIBIB

Tyre specifications and pressure table (bar & psi). Load per tyre in kg*

Ø inches	Description	CAI	S mm	OD mm	LR mm	RC mm	Recommended Rim		Acceptable Rim		Tube (Code)	75% internal volume (litres)	Tread depth (mm)		
38	380/95 R38 147A8/147B TL	836033	392	1689	769	5034	W12	W13	W13	W13	795	286	47		
Bar	0.4	0.5	0.6	0.8	1.0	1.2	1.4	1.6	1.8	2.0	2.1	2.3	2.4	2.6	2.8
Psi	6	7	9	12	15	17	20	23	26	29	30	33	35	38	41
10 km/h	1825	1980	2130	2440	2745	3055	3360	3670	3975	4100	4165	4295	4355	4485	4610
30 km/h	1300	1430	1555	1810	2070	2325	2580	2835	2950	3065	3120	3235	3290		
40 km/h			1450	1690	1930	2170	2410	2650	2755	2865	2915	3020	3075		
50 km/h			1450	1690	1930	2170	2410	2650	2755	2865	2915	3020	3075		
40 km/h Dual	1070	1150	1235	1395	1560	1725	1890	2050	2215	2380	2460	2625	2705		

Ø inches	Description	CAI	S mm	OD mm	LR mm	RC mm	Recommended Rim		Acceptable Rim		Tube (Code)	75% internal volume (litres)	Tread depth (mm)		
38	18.4 R38 151A8/148B TL	100097	494	1770	808	5267	DW16L	DW15L	W15L	W16L	824	431	54		
Bar	0.4	0.5	0.6	0.8	1.0	1.2	1.4	1.6	1.8	2.0	2.1	2.3	2.4	2.6	2.8
Psi	6	7	9	12	15	17	20	23	26	29	30	33	35	38	41
10 km/h	2100	2305	2515	2925	3340	3750	3920	4090	4325	4560	4675	4910	5025		
30 km/h	1660	1875	2085	2280	2480	2675	2945	3210	3400	3595	3690				
40 km/h			1950	2135	2315	2500	2750	3000	3180	3360	3450				
50 km/h			1775	1965	2155	2345	2540	2730	2895	3060	3140				
40 km/h Dual	1195	1455	1715	1900	2085	2270	2455	2640	2800	2955	3035				

Ø inches	Description	CAI	S mm	OD mm	LR mm	RC mm	Recommended Rim		Acceptable Rim		Tube (Code)	75% internal volume (litres)	Tread depth (mm)		
38	20.8 R38 159A8/156B TL	813266	541	1850	837	5506	DW18L	DW16L	W16L	W18L	825	524	57		
Bar	0.4	0.5	0.6	0.8	1.0	1.2	1.4	1.6	1.8	2.0	2.1	2.3	2.4	2.6	2.8
Psi	6	7	9	12	15	17	20	23	26	29	30	33	35	38	41
10 km/h	2550	2810	3065	3585	4100	4615	4895	5175	5495	5815	5910	6095	6190	6380	6565
30 km/h	1820	2015	2205	2525	2910	3290	3655	4015	4180	4350	4430	4595	4680		
40 km/h			2060	2360	2720	3075	3415	3750	3905	4065	4140	4295	4375		
50 km/h			1875	2150	2475	2800	3110	3415	3555	3700	3770	3910	3980		
40 km/h Dual			1810	2075	2390	2705	3005	3300	3440	3575	3645	3780	3850		

* Refer to the notes at the end of the tables of this range

MICHELIN AGRIBIB

Tyre specifications and pressure table (bar & psi). Load per tyre in kg*

Ø inches	Description	CAI	S mm	OD mm	LR mm	RC mm	Recommended Rim	Acceptable Rim	Tube (Code)	75% internal volume (litres)	Tread depth (mm)
38	520/85 R38 155A8/155B TL (20.8 R38)	303668	530	1855	821	5529	DW16L	DD16 DD18 DW16A W16A W18A	825	509	51
Bar	0.4 0.5 0.6 0.8 1.0 1.2 1.4 1.6 1.8							2.0 2.1 2.3 2.4 2.6 2.8			
Psi	6 7 9 12 15 17 20 23 26							29 30 33 35 38 41			
10 km/h	2650 2850 3050 3450 3850 4250 4625 5000 5535										
30 km/h	1900 2100 2300 2650 3050 3450 3790 4125										
40 km/h	2120 2500 2825 3150 3515 3875										
50 km/h	2120 2500 2800 3160 3515 3875										
40 km/h Dual	1540 1705 1865 2200 2485 2770 3090 3410										
max 40 km/h FRT	3000 3415 3825 4240 4650										

Ø inches	Description	CAI	S mm	OD mm	LR mm	RC mm	Recommended Rim	Acceptable Rim	Tube (Code)	75% internal volume (litres)	Tread depth (mm)
42	480/80 R42 156A8/156B TL (18.4 R42)	404096	494	1858	847	5538	DW16A	DD16 W16A	801	420	55
Bar	0.4 0.5 0.6 0.8 1.0 1.2 1.4 1.6 1.8							2.0 2.1 2.3 2.4 2.6 2.8			
Psi	6 7 9 12 15 17 20 23 26							29 30 33 35 38 41			
10 km/h	2325 2505 2690 3050 3415 3775 4140 4500 4750 5000 5125 5375 5500 5750 6000										
30 km/h	1660 1830 2000 2335 2675 3015 3350 3690 3840 3985 4060 4205 4280										
40 km/h	1850 2170 2490 2810 3130 3450 3590 3725 3795 3930 4000										
50 km/h	1850 2170 2490 2810 3130 3450 3590 3725 3795 3930 4000										
40 km/h Dual	1320 1465 1605 1890 2180 2465 2750 3035 3155 3280 3340 3460 3520										
max 40 km/h FRT	2600 2955 3315 3670 4030 4385 4455 4595 4660 4800										

Ø inches	Description	CAI	S mm	OD mm	LR mm	RC mm	Recommended Rim	Acceptable Rim	Tube (Code)	75% internal volume (litres)	Tread depth (mm)
42	520/85 R42 157A8/157B TL (20.8 R42)	122791	539	1945	869	5771	DW18A	DD18 W18A	802	545	59
Bar	0.4 0.5 0.6 0.8 1.0 1.2 1.4 1.6 1.8							2.0 2.1 2.3 2.4 2.6 2.8			
Psi	6 7 9 12 15 17 20 23 26							29 30 33 35 38 41			
10 km/h	2800 3015 3225 3650 4075 4500 4900 5300 5865										
30 km/h	2000 2180 2360 2800 3175 3550 3965 4375										
40 km/h	2240 2575 2965 3350 3740 4125										
50 km/h	2240 2575 3000 3350 3740 4125										
40 km/h Dual	1630 1800 1970 2265 2610 2950 3290 3630										
max 40 km/h FRT	3090 3555 4020 4485 4950										

* Refer to the notes at the end of the tables of this range

MICHELIN AGRIBIB

Tyre specifications and pressure table (bar & psi). Load per tyre in kg*

Ø inches	Description	CAI	S mm	OD mm	LR mm	RC mm	Recommended Rim	Acceptable Rim	Tube (Code)	75% internal volume (litres)	Tread depth (mm)				
46	420/80 R46 151A8/148B TL	122770	410	1872	861	5555	DW13	DW12	835	334	51				
Bar	0.4	0.5	0.6	0.8	1.0	1.2	1.4	1.6	1.8	2.0	2.1	2.3	2.4	2.6	2.8
Psi	6	7	9	12	15	17	20	23	26	29	30	33	35	38	41
10 km/h	2000	2170	2340	2675	3015	3350	3675	4000	4315	4625	4720	4905	5000	5075	5150
30 km/h	1450	1575	1700	2000	2290	2575	2865	3150	3300	3450	3500	3600	3650		
40 km/h			1600	1850	2140	2430	2665	2900	3075	3250	3300	3400	3450		
50 km/h			1450	1700	1950	2240	2445	2650	2800	3000	3040	3115	3150		
40 km/h Dual	1160	1285	1410	1630	1885	2140	2345	2550	2705	2860	2905	2990	3035		

Ø inches	Description	CAI	S mm	OD mm	LR mm	RC mm	Recommended Rim	Acceptable Rim	Tube (Code)	75% internal volume (litres)	Tread depth (mm)				
46	480/80 R46 158A8/158B TL <i>(18.4 R46)</i>	637231	499	1948	889	5874	DW16A	DD16 DW16L W16A	834	449	54				
Bar	0.4	0.5	0.6	0.8	1.0	1.2	1.4	1.6	1.8	2.0	2.1	2.3	2.4	2.6	2.8
Psi	6	7	9	12	15	17	20	23	26	29	30	33	35	38	41
10 km/h	2475	2675	2875	3275	3675	4075	4475	4875	5125	5375	5500	5755	5880	6130	6380
30 km/h	1770	1940	2110	2445	2785	3125	3460	3800	3990	4175	4270	4455	4550		
40 km/h			1950	2270	2590	2910	3230	3550	3725	3900	3990	4165	4250		
50 km/h			1950	2270	2590	2910	3230	3550	3725	3900	3990	4165	4250		
40 km/h Dual	1450	1585	1715	1940	2165	2390	2615	2840	3065	3290	3405	3630	3740		
max 40 km/h FRT				2725	3095	3465	3830	4200	4570	4660	4835	4925	5100		

Ø inches	Description	CAI	S mm	OD mm	LR mm	RC mm	Recommended Rim	Acceptable Rim	Tube (Code)	75% internal volume (litres)	Tread depth (mm)				
46	520/85 R46 158A8/155B TL <i>(20.8 R46)</i>	122780	515	2050	920	6088	DW16A	DW16L DW18A DW18L W16A W18A W18L	834	581	58				
Bar	0.4	0.5	0.6	0.8	1.0	1.2	1.4	1.6	1.8	2.0	2.1	2.3	2.4	2.6	2.8
Psi	6	7	9	12	15	17	20	23	26	29	30	33	35	38	41
10 km/h	2900	3115	3325	3750	4175	4600	5025	5450	6070						
30 km/h	2090	2295	2500	2910	3320	3730	4140	4550							
40 km/h			2300	2690	3080	3470	3860	4250							
50 km/h			2120	2470	2820	3175	3525	3875							
40 km/h Dual	1715	1885	2055	2390	2730	3065	3400	3740							
max 40 km/h FRT				3230	3700	4165	4635	5100							

* Refer to the notes at the end of the tables of this range

MICHELIN AGRIBIB

Tyre specifications and pressure table (bar & psi). Load per tyre in kg*

Ø inches	Description	CAI	S mm	OD mm	LR mm	RC mm	Recommended Rim		Acceptable Rim		Tube (Code)	75% internal volume (litres)	Tread depth (mm)		
50	480/80 R50 159A8/159B TL	471947	474	2056	942	6135	DW15A	DW16A				479	56		
Bar	0.4	0.5	0.6	0.8	1.0	1.2	1.4	1.6	1.8	2.0	2.1	2.3	2.4	2.6	2.8
Psi	6	7	9	12	15	17	20	23	26	29	30	33	35	38	41
10 km/h	2575	2785	2995	3415	3830	4250	4700	5150	5575	6000	6075	6225	6300	6400	6500
30 km/h	1800	1990	2180	2575	2915	3250	3625	4000	4190	4375	4440	4565	4625		
40 km/h			2060	2360	2720	3075	3415	3750	3940	4125	4190	4315	4375		
50 km/h			2060	2360	2725	3075	3415	3750	3875	4125	4190	4315	4375		
40 km/h Dual	1495	1655	1815	2075	2390	2705	3005	3300	3465	3630	3685	3795	3850		
max 40 km/h FRT				2830	3230	3635	4035	4440	4840	4910	5045	5115	5250		

Ø inches	Description	CAI	S mm	OD mm	LR mm	RC mm	Recommended Rim		Acceptable Rim		Tube (Code)	75% internal volume (litres)	Tread depth (mm)		
50	480/95 R50 164A8/164B TL	491183	515	2175	992	6484	DW16B (A)	DW15B (A)				593	53		
Bar	0.4	0.5	0.6	0.8	1.0	1.2	1.4	1.6	1.8	2.0	2.1	2.3	2.4	2.6	2.8
Psi	6	7	9	12	15	17	20	23	26	29	30	33	35	38	41
10 km/h	2925	3100	3270	3780	4285	4795	5300	5810	6185	6560	6750	7125	7310	7405	7500
30 km/h	2085	2305	2525	2955	3385	3820	4250	4680	4850	5015	5100	5265	5350		
40 km/h			2360	2765	3165	3570	3970	4375	4530	4690	4765	4920	5000		
50 km/h			2360	2765	3165	3570	3970	4375	4530	4690	4765	4920	5000		
40 km/h Dual	1720	1900	2080	2435	2790	3140	3495	3850	3990	4125	4195	4330	4400		
max 40 km/h FRT				3320	3760	4205	4645	5090	5530	5610	5765	5845	6000		

***IMPORTANT:**

The inflation pressure must always be appropriate for the load per tyre, the speed of travel and the work to be done. Our recommendations above were correct as of the time of publication of these tables (June 2018). Technical data is subject to change without prior notice.

- For ploughing and other field applications subject to high torque, use the 20 mph column.
- When using single tyre configuration:
 - add 6 psi for use on slopes of more than 20%
 - add 6 psi for intense road use exceeding 50%
- **10 km/h LT (Low Torque) (max speed 6 mph).
- FRT: Free Rolling Tyre



MICHELIN CEREXBIB 2

**HIGH PRODUCTIVITY
& OUTSTANDING SOIL
PROTECTION**



FOR HARVESTING MACHINES



CFO+ RATED TYRE

- Carry more load at 10 km/h cyclic in the field
- -45% pressure vs non CFO+ radial tyre in the same size⁽¹⁾



BETTER YIELDS

- Potential increase in yields of up to 4% year⁽²⁾



SOIL PROTECTION

- Low pressure in the fields



TRACTION & FLOTATION



LARGE FOOTPRINT

- Soil protection and optimisation of future harvests

(1) For 12 000 kg, compared to a 900/60R32 Michelin Megaxbib standard radial (2) Harper Adams University 2014/2016

SIZES

VF 520/80 R26 CFO+ 168A8 TL
VF 620/70 R26 CFO+ 173A8 TL
VF 750/65 R26 CFO+ 180A8 TL
VF 620/70 R30 CFO+ 175A8 TL
VF 520/85 R30 CFO+ 172A8 TL
VF 710/65 R30 CFO+ 179A8 TL

IF 800/65 R32 CFO+ 181A8 TL
VF 900/60 R32 CFO+ 191A8 TL
IF 800/70 R32 CFO+ 185A8 TL
VF 500/85 R34 CFO+ 172A8 TL
IF 680/80 R38 CFO+ 182A8 TL
VF 900/60 R38 CFO+ 193A8 TL

IF 800/70 R38 CFO+ 187A8 TL
VF 520/85 R42 CFO+ 177A8 TL
VF 580/85 R42 CFO+ 183A8 TL
VF 710/70 R42 CFO+ 188A8 TL
VF 900/60 R42 CFO+ 195A8 TL
IF 800/70 R42 CFO+ 189A8 TL

MICHELIN CEREXBIB 2

Tyre specifications and pressure table (bar & psi). Load per tyre in kg*

Ø inches	Description	CAI	S mm	OD mm	LR mm	RC mm	Recommended Rim	Acceptable Rim	Tube (Code)	75% internal volume (litres)	Tread depth (mm)				
26	VF 520/80 R26 CFO+ 168A8 TL	850494	503	1491	649	4400	DW16L	DW18LW16L	716	366	44				
Bar	1.2	1.4	1.6	1.7	1.8	1.9	2.0	2.1	2.2	2.3	2.4	2.5	2.6	2.7	2.8
Psi	17	20	23	25	26	28	29	30	32	33	35	36	38	39	41
10 km/h Cyc	5230	5805	6375	6510	6645	6775	6910	7045	7175	7310	7440	7600	7760	7915	8075
15 km/h Cyc	4765	5290	5815	5935	6060	6180	6300	6420	6540	6660	6780	6925	7075	7220	7365
40 km/h	3550	3965	4375	4470	4570	4665	4760	4860	4955	5055	5150	5265	5375	5490	5600

Ø inches	Description	CAI	S mm	OD mm	LR mm	RC mm	Recommended Rim	Acceptable Rim	Tube (Code)	75% internal volume (litres)	Tread depth (mm)				
26	VF 620/70 R26 CFO+ 173A8 TL	228272	606	1513	655	4461	DW20B (A)		716	463	45				
Bar	1.2	1.4	1.6	1.7	1.8	1.9	2.0	2.1	2.2	2.3	2.4	2.5	2.6	2.7	2.8
Psi	17	20	23	25	26	28	29	30	32	33	35	36	38	39	41
10 km/h Cyc	6035	6740	7440	7605	7770	7935	8100	8265	8430	8590	8755	8945	9140	9330	9520
15 km/h Cyc	5505	6145	6780	6930	7080	7230	7380	7530	7685	7835	7985	8160	8335	8505	8680
40 km/h	4125	4640	5150	5255	5365	5470	5575	5680	5790	5895	6000	6125	6250	6375	6500

Ø inches	Description	CAI	S mm	OD mm	LR mm	RC mm	Recommended Rim	Acceptable Rim	Tube (Code)	75% internal volume (litres)	Tread depth (mm)				
26	VF 750/65 R26 CFO+ 180A8 TL	132266	748	1623	701	4786	DW25B (A)		833	659	48				
Bar	1.2	1.4	1.6	1.7	1.8	1.9	2.0	2.1	2.2	2.3	2.4	2.5	2.6	2.7	2.8
Psi	17	20	23	25	26	28	29	30	32	33	35	36	38	39	41
10 km/h Cyc	7440	8225	9010	9225	9435	9650	9860	10075	10285	10500	10710	10965	11220	11475	11730
15 km/h Cyc	6780	7500	8215	8410	8605	8795	8990	9185	9380	9570	9765	10000	10230	10465	10695
40 km/h	5150	5650	6150	6295	6440	6580	6725	6870	7015	7155	7300	7475	7650	7825	8000

Ø inches	Description	CAI	S mm	OD mm	LR mm	RC mm	Recommended Rim	Acceptable Rim	Tube (Code)	75% internal volume (litres)	Tread depth (mm)				
30	VF 620/70 R30 CFO+ 175A8 TL	049288	608	1615	700	4765	DW20B (A)		737	506	43				
Bar	1.2	1.4	1.6	1.7	1.8	1.9	2.0	2.1	2.2	2.3	2.4	2.5	2.6	2.7	2.8
Psi	17	20	23	25	26	28	29	30	32	33	35	36	38	39	41
10 km/h Cyc	6375	7120	7865	8040	8215	8390	8565	8740	8915	9090	9265	9500	9735	9965	10200
15 km/h Cyc	5815	6495	7170	7330	7490	7650	7810	7970	8130	8290	8450	8665	8875	9090	9300
40 km/h	4500	4975	5450	5555	5665	5770	5875	5980	6090	6195	6300	6450	6600	6750	6900

* Refer to the notes at the end of the tables of this range

MICHELIN CEREXBIB 2

Tyre specifications and pressure table (bar & psi). Load per tyre in kg*

Ø inches	Description	CAI	S mm	OD mm	LR mm	RC mm	Recommended Rim	Acceptable Rim	Tube (Code)	75% internal volume (litres)	Tread depth (mm)				
30	VF 520/85 R30 CFO+ 172A8 TL	188276	522	1624	709	4797	W16L		737	435	46				
Bar	1.2	1.4	1.6	1.7	1.8	1.9	2.0	2.1	2.2	2.3	2.4	2.5	2.6	2.7	2.8
Psi	17	20	23	25	26	28	29	30	32	33	35	36	38	39	41
10 km/h Cyc	5865	6545	7225	7360	7495	7625	7760	7895	8025	8160	8290	8535	8780	9020	9265
15 km/h Cyc	5350	5970	6590	6710	6830	6950	7070	7190	7315	7435	7555	7780	8005	8225	8450
40 km/h	4000	4440	4875	4990	5110	5225	5340	5455	5570	5685	5800	5925	6050	6175	6300

Ø inches	Description	CAI	S mm	OD mm	LR mm	RC mm	Recommended Rim	Acceptable Rim	Tube (Code)	75% internal volume (litres)	Tread depth (mm)				
30	VF 710/65 R30 CFO+ 179A8 TL	608814	694	1676	735	4952	DW25B (A)	DW23B (A)		630	46				
Bar	1.2	1.4	1.6	1.7	1.8	1.9	2.0	2.1	2.2	2.3	2.4	2.5	2.6	2.7	2.8
Psi	17	20	23	25	26	28	29	30	32	33	35	36	38	39	41
10 km/h Cyc	7225	7990	8755	8970	9180	9395	9605	9820	10030	10245	10455	10690	10925	11155	11390
15 km/h Cyc	6590	7290	7985	8180	8375	8565	8760	8955	9150	9340	9535	9750	9960	10175	10385
40 km/h	5000	5500	6000	6140	6275	6415	6550	6690	6825	6965	7100	7265	7425	7590	7750

Ø inches	Description	CAI	S mm	OD mm	LR mm	RC mm	Recommended Rim	Acceptable Rim	Tube (Code)	75% internal volume (litres)	Tread depth (mm)				
32	IF 800/65 R32 CFO+ 181A8 TL	987406	772	1855	826	5501	DW27B (A)		831	903	57				
Bar	1.2	1.4	1.6	1.7	1.8	1.9	2.0	2.1	2.2	2.3	2.4	2.5	2.6	2.7	2.8
Psi	17	20	23	25	26	28	29	30	32	33	35	36	38	39	41
10 km/h Cyc	9010	9860	10710	10965	11220	11475	11730	11985	12240	12495	12750	13070	13390	13705	14025
15 km/h Cyc	8215	8990	9765	10000	10230	10465	10695	10930	11160	11395	11625	11915	12210	12500	12790
40 km/h	5300	5800	6300	6450	6600	6750	6900	7050	7200	7350	7500	7690	7875	8065	8250

Ø inches	Description	CAI	S mm	OD mm	LR mm	RC mm	Recommended Rim	Acceptable Rim	Tube (Code)	75% internal volume (litres)	Tread depth (mm)				
32	VF 900/60 R32 CFO+ 191A8 TL	430737	893	1903	827	5618	DW27B (A)	DW30B (A)	831	1,033	58				
Bar	1.2	1.4	1.6	1.7	1.8	1.9	2.0	2.1	2.2	2.3	2.4	2.5	2.6	2.7	2.8
Psi	17	20	23	25	26	28	29	30	32	33	35	36	38	39	41
10 km/h Cyc	9860	10965	12070	12370	12665	12965	13260	13560	13855	14155	14450	14770	15090	15405	15725
15 km/h Cyc	8990	10000	11005	11275	11550	11820	12090	12360	12635	12905	13175	13465	13760	14050	14340
40 km/h	6700	7475	8250	8470	8690	8905	9125	9345	9565	9780	10000	10225	10450	10675	10900

* Refer to the notes at the end of the tables of this range

MICHELIN CEREXBIB 2

Tyre specifications and pressure table (bar & psi). Load per tyre in kg*

Ø inches	Description	CAI	S mm	OD mm	LR mm	RC mm	Recommended Rim	Acceptable Rim	Tube (Code)	75% internal volume (litres)	Tread depth (mm)				
32	IF 800/70 R32 CFO+ 185A8 TL	789156	796	1950	864	5800	DW27B (A)		831	966	55				
Bar	1.2	1.4	1.6	1.7	1.8	1.9	2.0	2.1	2.2	2.3	2.4	2.5	2.6	2.7	2.8
Psi	17	20	23	25	26	28	29	30	32	33	35	36	38	39	41
10 km/h Cyc	9860	10965	12070	12370	12665	12965	13260	13560	13855	14155	14450	14770	15090	15405	15725
15 km/h Cyc	8990	10000	11005	11275	11550	11820	12090	12360	12635	12905	13175	13465	13760	14050	14340
40 km/h	5800	6450	7100	7275	7450	7625	7800	7975	8150	8325	8500	8690	8875	9065	9250

Ø inches	Description	CAI	S mm	OD mm	LR mm	RC mm	Recommended Rim	Acceptable Rim	Tube (Code)	75% internal volume (litres)	Tread depth (mm)				
34	VF 500/85 R34 CFO+ 172A8 TL	038009	497	1676	741	4961	DW16L	DW18L		431	46				
Bar	1.2	1.4	1.6	1.7	1.8	1.9	2.0	2.1	2.2	2.3	2.4	2.5	2.6	2.7	2.8
Psi	17	20	23	25	26	28	29	30	32	33	35	36	38	39	41
10 km/h Cyc	5870	6445	7020	7180	7340	7495	7655	7815	7975	8130	8290	8470	8650	8830	9010
15 km/h Cyc	5350	5875	6400	6545	6690	6835	6980	7125	7270	7415	7560	7725	7890	8055	8220
40 km/h	4000	4440	4875	4965	5060	5150	5240	5330	5420	5510	5600	5775	5950	6125	6300

Ø inches	Description	CAI	S mm	OD mm	LR mm	RC mm	Recommended Rim	Acceptable Rim	Tube (Code)	75% internal volume (litres)	Tread depth (mm)				
38	IF 680/80 R38 CFO+ 182A8 TL	953912	646	2020	904	6030	DW21B	DW23B (A)	804	877	59				
Bar	1.2	1.4	1.6	1.7	1.8	1.9	2.0	2.1	2.2	2.3	2.4	2.5	2.6	2.7	2.8
Psi	17	20	23	25	26	28	29	30	32	33	35	36	38	39	41
10 km/h Cyc	9265	10330	11390	11615	11835	12060	12285	12505	12730	12950	13175	13495	13815	14130	14450
15 km/h Cyc	8450	9420	10385	10590	10795	10995	11200	11405	11610	11810	12015	12305	12595	12885	13175
30 km/h Cyc	7085	7900	8710	8880	9050	9220	9395	9565	9735	9905	10075	10320	10565	10805	11050
40 km/h	5450	6075	6700	6830	6965	7095	7225	7355	7490	7620	7750	7940	8125	8315	8500

Ø inches	Description	CAI	S mm	OD mm	LR mm	RC mm	Recommended Rim	Acceptable Rim	Tube (Code)	75% internal volume (litres)	Tread depth (mm)				
38	VF 900/60 R38 CFO+ 193A8 TL	439024	879	2029	889	5993	DW30B (A)			1,149	58				
Bar	1.2	1.4	1.6	1.7	1.8	1.9	2.0	2.1	2.2	2.3	2.4	2.5	2.6	2.7	2.8
Psi	17	20	23	25	26	28	29	30	32	33	35	36	38	39	41
10 km/h Cyc	10455	11605	12750	13070	13390	13705	14025	14345	14665	14980	15300	15725	16150	16575	17000
15 km/h Cyc	9765	10885	12000	12245	12490	12730	12975	13220	13465	13705	13950	14350	14750	15150	15550
40 km/h	7300	8025	8750	8980	9215	9445	9675	9905	10140	10370	10600	10825	11050	11275	11500

* Refer to the notes at the end of the tables of this range

MICHELIN CEREXBIB 2

Tyre specifications and pressure table (bar & psi). Load per tyre in kg*

Ø inches	Description	CAI	S mm	OD mm	LR mm	RC mm	Recommended Rim		Acceptable Rim		Tube (Code)	75% internal volume (litres)	Tread depth (mm)		
38	IF 800/70 R38 CFO+ 187A8 TL	610997	790	2051	912	6079	DW27B (A)				804	1,088	57		
Bar	1.2 1.4 1.6	1.7 1.8 1.9	2.0 2.1 2.2	2.3 2.4 2.5	2.6 2.7 2.8	2.8 2.9 3.0	3.1 3.2 3.3	3.4 3.5 3.6	3.7 3.8 3.9	4.0 4.1 4.2					
Psi	17 20 23	25 26 28	29 30 32	33 35 36	38 39 41	42 43 44	45 46 47	48 49 50	51 52 53	54 55 56					
10 km/h Cyc	10710	11945	13175	13440	13705	13970	14240	14505	14770	15035	15300	15620	15940	16255	16575
15 km/h Cyc	9765	10885	12000	12245	12490	12730	12975	13220	13465	13705	13950	14240	14530	14820	15110
40 km/h	6300	7025	7750	7905	8065	8220	8375	8530	8690	8845	9000	9190	9375	9565	9750

Ø inches	Description	CAI	S mm	OD mm	LR mm	RC mm	Recommended Rim		Acceptable Rim		Tube (Code)	75% internal volume (litres)	Tread depth (mm)		
42	VF 520/85 R42 CFO+ 177A8 TL	270459	541	1953	881	5807	DW18B(A)		DD18 W18L		802	545	55		
Bar	1.2 1.4 1.6	1.7 1.8 1.9	2.0 2.1 2.2	2.3 2.4 2.5	2.6 2.7 2.8	2.8 2.9 3.0	3.1 3.2 3.3	3.4 3.5 3.6	3.7 3.8 3.9	4.0 4.1 4.2					
Psi	17 20 23	25 26 28	29 30 32	33 35 36	38 39 41	42 43 44	45 46 47	48 49 50	51 52 53	54 55 56					
10 km/h Cyc Dual	5985	6640	7295	7470	7640	7815	7985	8160	8330	8505	8675	8865	9050	9240	9425
15 km/h Cyc Dual	5455	6055	6650	6810	6965	7125	7280	7440	7595	7755	7910	8080	8255	8425	8595
40 km/h	4625	5215	5800	5915	6025	6140	6250	6365	6475	6590	6700	6850	7000	7150	7300

Ø inches	Description	CAI	S mm	OD mm	LR mm	RC mm	Recommended Rim		Acceptable Rim		Tube (Code)	75% internal volume (litres)	Tread depth (mm)		
42	VF 580/85 R42 CFO+ 183A8 TL	844076	580	2040	903	6040	DW18B(A)				802	701	58		
Bar	1.2 1.4 1.6	1.7 1.8 1.9	2.0 2.1 2.2	2.3 2.4 2.5	2.6 2.7 2.8	2.8 2.9 3.0	3.1 3.2 3.3	3.4 3.5 3.6	3.7 3.8 3.9	4.0 4.1 4.2					
Psi	17 20 23	25 26 28	29 30 32	33 35 36	38 39 41	42 43 44	45 46 47	48 49 50	51 52 53	54 55 56					
10 km/h Cyc	8075	8970	9860	10050	10245	10435	10625	10815	11010	11200	11390	11730	12070	12410	12750
15 km/h Cyc	7365	8180	8990	9165	9340	9515	9690	9860	10035	10210	10385	10695	11005	11315	11625
10 km/h Cyc Dual	7110	7895	8680	8850	9015	9185	9350	9520	9685	9855	10020	10320	10620	10920	11220
15 km/h Cyc Dual	6480	7195	7910	8065	8220	8370	8525	8680	8835	8985	9140	9415	9685	9960	10230
40 km/h	5450	6075	6700	6865	7025	7190	7350	7515	7675	7840	8000	8190	8375	8565	8750

Ø inches	Description	CAI	S mm	OD mm	LR mm	RC mm	Recommended Rim		Acceptable Rim		Tube (Code)	75% internal volume (litres)	Tread depth (mm)		
42	VF 710/70 R42 CFO+ 188A8 TL	499992	705	2097	927	6207	DW23B (A)		DW25B (A)		802	867	64		
Bar	1.2 1.4 1.6	1.7 1.8 1.9	2.0 2.1 2.2	2.3 2.4 2.5	2.6 2.7 2.8	2.8 2.9 3.0	3.1 3.2 3.3	3.4 3.5 3.6	3.7 3.8 3.9	4.0 4.1 4.2					
Psi	17 20 23	25 26 28	29 30 32	33 35 36	38 39 41	42 43 44	45 46 47	48 49 50	51 52 53	54 55 56					
10 km/h Cyc	9265	10330	11390	11615	11835	12060	12280	12505	12730	12950	13175	13495	13815	14130	14450
15 km/h Cyc	8450	9420	10385	10590	10795	10995	11200	11405	11610	11810	12015	12305	12595	12885	13175
40 km/h		7750	7905	8065	8220	8375	8530	8690	8845	9000	9250	9500	9750	10000	

* Refer to the notes at the end of the tables of this range

MICHELIN CEREXBIB 2

Tyre specifications and pressure table (bar & psi). Load per tyre in kg*

Ø inches	Description	CAI	S mm	OD mm	LR mm	RC mm	Recommended Rim		Acceptable Rim		Tube (Code)	75% internal volume (litres)		Tread depth (mm)	
42	VF 900/60 R42 CFO+ 195A8 TL	856296	843	2118	930	6281	DW30B (A)		TW30B			1,227		59	
Bar	1.2	1.4	1.6	1.7	1.8	1.9	2.0	2.1	2.2	2.3	2.4	2.5	2.6	2.7	2.8
Psi	17	20	23	25	26	28	29	30	32	33	35	36	38	39	41
10 km/h Cyc	11050	12325	13600	13920	14240	14555	14875	15195	15515	15830	16150	16490	16830	17170	17510
15 km/h Cyc	10075	11240	12400	12690	12985	13275	13565	13855	14145	14435	14725	15035	15345	15655	15965
30 km/h Cyc	8450	9425	10400	10645	10890	11130	11375	11620	11865	12105	12350	12610	12870	13130	13390
40 km/h	7500	8375	9250	9515	9775	10040	10300	10525	10750	10975	11200	11440	11675	11915	12150

Ø inches	Description	CAI	S mm	OD mm	LR mm	RC mm	Recommended Rim		Acceptable Rim		Tube (Code)	75% internal volume (litres)		Tread depth (mm)	
42	IF 800/70 R42 CFO+ 189A8 TL	818789	770	2151	964	6387	DW27B (A)		DW25B (A) DW28B (A)			1,145		58	
Bar	1.2	1.4	1.6	1.7	1.8	1.9	2.0	2.1	2.2	2.3	2.4	2.5	2.6	2.7	2.8
Psi	17	20	23	25	26	28	29	30	32	33	35	36	38	39	41
10 km/h Cyc	11050	12325	13600	13920	14240	14555	14875	15195	15515	15830	16150	16490	16830	17170	17510
15 km/h Cyc	10075	11240	12400	12690	12980	13270	13565	13855	14145	14435	14725	15035	15345	15655	15965
30 km/h Cyc	8450	9425	10400	10645	10890	11130	11375	11620	11865	12105	12350	12610	12870	13130	13390
40 km/h	6500	7250	8000	8190	8375	8565	8750	8940	9125	9315	9500	9700	9900	10100	10300

***IMPORTANT:**

The inflation pressure must always be appropriate for the load per tyre, the speed of travel and the work to be done. Our recommendations above were correct as of the time of publication of these tables (June 2018). Technical data is subject to change without prior notice.

- For standard or slope correction machines working on slopes of over 20% (11°), increase the usage pressure by 0.5 bar without exceeding the maximum load.
- Add 0.4 bar for use on slopes of more than 20%
- Add 0.4 bar for intense road use exceeding 50% of time on road.
- 10 km/h Cyc: Harvesting work with cyclic loads at 10 km/h.
- 15 km/h Cyc: Harvesting work with cyclic loads at 15 km/h.
- 30 km/h Cyc: Harvesting work with cyclic loads at 30 km/h.
- CFO+: Cyclic Field Operation generating a bonus for cyclic loads in the field at 10 km/h and 15 km/h. (1,5 km maximum distance fully loaded)



MICHELIN CEREXBIB

**HIGH LOAD CAPACITY
AT LOW PRESSURE
FOR LARGE HARVESTING
MACHINERY**



For **harvesting machines**



BETTER YIELDS

- Potential increase in yields of up to 4% year⁽¹⁾



Superb **LOAD CAPACITY**



MORE TRACTION

- Improved traction on slopes
- Ability to work on wet ground
- +25%⁽³⁾ bigger footprint



LOWER PRESSURE

- Operates at up to 1 bar lower pressure compared to previous generation tyre (-35%)⁽²⁾



LARGE FOOTPRINT

- Less compacted soil
- Shallower ruts

(1) Harper Adams University 2014/2016 (2) IF 1000/55 R32 CFO MICHELIN CEREXBIB vs 1050/50 R32 MICHELIN MEGAXBIB

SIZES

VF 520/80 R26 CFO 168A8 TL

VF 620/70 R26 CFO 173A8 TL

VF 750/65 R26 CFO 177A8 TL

VF 620/70 R30 CFO 172A8 TL

VF 520/85 R30 CFO 172A8 TL

IF 800/65 R32 CFO 178A8 TL

IF 900/60 R32 CFO 185A8 TL

IF 1000/55 R32 CFO 188A8 TL

IF 680/85 R32 CFO 179A8 TL

IF 800/70 R32 CFO 182A8 TL

IF 680/75 R38 CFO 180A8 TL

IF 900/60 R38 CFO 188A8 TL

IF 900/60 R38 CFO 184A8 TL

IF 800/70 R38 CFO 184A8 TL

IF 800/70 R38 CFO 187A8 TL

VF 520/85 R42 CFO 177A8 TL

IF 710/70 R42 CFO 182A8 TL

MICHELIN CEREXBIB

Tyre specifications and pressure table (bar & psi). Load per tyre in kg*

Ø inches	Description	CAI	S mm	OD mm	LR mm	RC mm	Recommended Rim	Acceptable Rim	Tube (Code)	75% internal volume (litres)	Tread depth (mm)				
26	VF 520/80 R26 CFO 168A8 TL	972024	503	1491	649	4397	DW16L	DW18LW16L	716	366	44				
Bar	1.2 1.4 1.6	1.7 1.8 1.9	2.0 2.1 2.2	2.3 2.4	2.5 2.6 2.7	2.8									
Psi	17 20 23	25 26 28	29 30 32	33 35	36 38 39	41									
15 km/h Cyc	4720	5270	5820	5950	6080	6205	6335	6465	6595	6720	6850	7000	7150	7300	7450
40 km/h	3550	3965	4375	4470	4570	4665	4765	4860	4955	5055	5150	5265	5375	5490	5600

Ø inches	Description	CAI	S mm	OD mm	LR mm	RC mm	Recommended Rim	Acceptable Rim	Tube (Code)	75% internal volume (litres)	Tread depth (mm)				
26	VF 620/70 R26 CFO 173A8 TL	656967	606	1513	655	4458	DW20B (A)		716	463	45				
Bar	1.2 1.4 1.6	1.7 1.8 1.9	2.0 2.1 2.2	2.3 2.4	2.5 2.6 2.7	2.8									
Psi	17 20 23	25 26 28	29 30 32	33 35	36 38 39	41									
15 km/h Cyc	5485	6170	6850	6990	7135	7275	7415	7555	7700	7840	7980	8150	8315	8485	8650
40 km/h	4125	4640	5150	5255	5365	5470	5575	5680	5790	5895	6000	6125	6250	6375	6500

Ø inches	Description	CAI	S mm	OD mm	LR mm	RC mm	Recommended Rim	Acceptable Rim	Tube (Code)	75% internal volume (litres)	Tread depth (mm)				
26	VF 750/65 R26 CFO 177A8 TL	811382	743	1623	701	4780	DW25B (A)		833	659	48				
Bar	1.2 1.4 1.6	1.7 1.8 1.9	2.0 2.1 2.2	2.3 2.4	2.5 2.6 2.7	2.8									
Psi	17 20 23	25 26 28	29 30 32	33 35	36 38 39	41									
15 km/h Cyc	6850	7515	8180	8370	8565	8755	8945	9135	9330	9520	9710				
40 km/h	5150	5650	6150	6295	6440	6580	6725	6870	7015	7155	7300				

Ø inches	Description	CAI	S mm	OD mm	LR mm	RC mm	Recommended Rim	Acceptable Rim	Tube (Code)	75% internal volume (litres)	Tread depth (mm)				
30	VF 620/70 R30 CFO 172A8 TL <i>Tyre for harvesting machinery</i>	886789	598	1615	700	4760	DW20B (A)		737	506	43				
Bar	1.2 1.4 1.6	1.7 1.8 1.9	2.0 2.1 2.2	2.3 2.4	2.5 2.6 2.7	2.8									
Psi	17 20 23	25 26 28	29 30 32	33 35	36 38 39	41									
15 km/h Cyc	5985	6620	7250	7390	7535	7675	7815	7955	8100	8240	8380				
40 km/h	4500	4975	5450	5555	5665	5770	5875	5980	6090	6195	6300				

Ø inches	Description	CAI	S mm	OD mm	LR mm	RC mm	Recommended Rim	Acceptable Rim	Tube (Code)	75% internal volume (litres)	Tread depth (mm)				
30	VF 520/85 R30 CFO 172A8 TL	795916	522	1624	709	4794	W16L		737	435	46				
Bar	1.2 1.4 1.6	1.7 1.8 1.9	2.0 2.1 2.2	2.3 2.4	2.5 2.6 2.7	2.8									
Psi	17 20 23	25 26 28	29 30 32	33 35	36 38 39	41									
15 km/h Cyc	5320	5905	6485	6640	6795	6945	7100	7255	7410	7560	7715	7880	8050	8215	8380
40 km/h	4000	4440	4875	4990	5105	5220	5340	5455	5570	5685	5800	5925	6050	6175	6300

* Refer to the notes at the end of the tables of this range

MICHELIN CEREXBIB

Tyre specifications and pressure table (bar & psi). Load per tyre in kg*

Ø inches	Description	CAI	S mm	OD mm	LR mm	RC mm	Recommended Rim		Acceptable Rim	Tube (Code)	75% internal volume (litres)	Tread depth (mm)	
32	IF 800/65 R32 CFO 178A8 TL <i>Tyre for harvesting machinery</i>	651074	768	1855	818	5493	DW27B (A)		DW30B (A)	831	903	57	
Bar	1.2 1.4 1.6	1.7	1.8	1.9	2.0	2.1	2.2	2.3	2.4	2.5	2.6	2.7	2.8
Psi	17 20 23	25	26	28	29	30	32	33	35	36	38	39	41
15 km/h Cyc	8215 8990 9765	10000	10230	10465	10695	10930	11160	11395	11625				
40 km/h	5300 5800 6300	6450	6600	6750	6900	7050	7200	7350	7500				

Ø inches	Description	CAI	S mm	OD mm	LR mm	RC mm	Recommended Rim		Acceptable Rim	Tube (Code)	75% internal volume (litres)	Tread depth (mm)	
32	IF 900/60 R32 CFO 185A8 TL	752825	856	1906	844	5643	DW27B (A)		DW30B (A)	831	1,033	58	
Bar	1.2 1.4 1.6 1.7	1.8	1.9	2.0	2.1	2.2	2.3	2.4	2.5	2.6	2.7	2.8	
Psi	17 20 23 25	26	28	29	30	32	33	35	36	38	39	41	
15 km/h Cyc	8990 9995 11000	11270	11545	11815	12090	12360	12630	12905	13175	13465	13760	14050	14340
40 km/h	5800 6450 7100	7275	7450	7625	7800	7975	8150	8325	8500	8690	8875	9065	9250

Ø inches	Description	CAI	S mm	OD mm	LR mm	RC mm	Recommended Rim		Acceptable Rim	Tube (Code)	75% internal volume (litres)	Tread depth (mm)	
32	IF 1000/55 R32 CFO 188A8 TL	131720	1040	1931	882	5758	36.00VA			Joint OR2052	1,178	59	
Bar	1.2 1.4 1.6 1.7	1.8	1.9	2.0	2.1	2.2	2.3	2.4	2.5	2.6	2.7	2.8	
Psi	17 20 23 25	26	28	29	30	32	33	35	36	38	39	41	
15 km/h Cyc	9765 10890 12015	12305	12595	12885	13180	13470	13760	14050	14340	14630	14920	15210	15500
40 km/h	6300 7025 7750	7940	8125	8315	8500	8690	8875	9065	9250	9440	9625	9815	10000

Ø inches	Description	CAI	S mm	OD mm	LR mm	RC mm	Recommended Rim		Acceptable Rim	Tube (Code)	75% internal volume (litres)	Tread depth (mm)
32	IF 800/65 R32 CFO 179A8 TL	932041	682	1935	844	5711	DW23B (A)		DW21B (A)	831	859	46
Bar	1.2 1.4 1.6 1.7	1.8	1.9	2.0	2.1	2.2	2.3	2.4	2.5	2.6	2.7	2.8
Psi	17 20 23 25	26	28	29	30	32	33	35	36	38	39	41
15 km/h Cyc	8450 9420 10385	10590	10795	10995	11200	11405	11610	11810	12015			
40 km/h	5450 6075 6700	6830	6965	7095	7225	7355	7490	7620	7750			

Ø inches	Description	CAI	S mm	OD mm	LR mm	RC mm	Recommended Rim		Acceptable Rim	Tube (Code)	75% internal volume (litres)	Tread depth (mm)
32	IF 800/70 R32 CFO 182A8 TL	525718	784	1958	864	5788	DW27B (A)			831	966	55
Bar	1.2 1.4 1.6 1.7	1.8	1.9	2.0	2.1	2.2	2.3	2.4	2.5	2.6	2.7	2.8
Psi	17 20 23 25	26	28	29	30	32	33	35	36	38	39	41
15 km/h Cyc	8990 10000 11005	11275	11550	11820	12090	12360	12635	12905	13175			
40 km/h	5800 6450 7100	7275	7450	7625	7800	7975	8150	8325	8500			

* Refer to the notes at the end of the tables of this range

MICHELIN CEREXBIB

Tyre specifications and pressure table (bar & psi). Load per tyre in kg*

Ø inches	Description	CAI	S mm	OD mm	LR mm	RC mm	Recommended Rim		Acceptable Rim		Tube (Code)	75% internal volume (litres)	Tread depth (mm)
38	IF 680/75 R38 CFO 180A8 TL	833220	663	1965	874	5823	DW23B (A)		DW21B (A)			803	59
Bar	1.2 1.4 1.6	1.7 1.8 1.9	2.0 2.1 2.2	2.3 2.4 2.5	2.6 2.7 2.8	2.8 2.9 3.0	3.1 3.2 3.3	3.4 3.5 3.6	3.7 3.8 3.9	4.0 4.1 4.2			
Psi	17 20 23	25 26 28	29 30 32	33 35 36	38 39 41	42 43 44	45 46 47	48 49 50	51 52 53	54 55 56			
15 km/h Cyc	7980 8875 9765	10000 10230 10465	10695 10930 11160	11395 11625 11820	12015 12205 12400								
15 km/h Cyc > slope 20%		7980 8425 8875	9320 9765 10000	10230 10465 10695	10930 11160 11395								
40 km/h	5150 5725 6300	6450 6600 6750	6900 7050 7200	7350 7500 7625	7750 7875 8000								

Ø inches	Description	CAI	S mm	OD mm	LR mm	RC mm	Recommended Rim		Acceptable Rim		Tube (Code)	75% internal volume (litres)	Tread depth (mm)
38	IF 900/60 R38 CFO 188A8 TL <i>Textile belted</i>	853436	879	2029	902	6017	DW30B (A)					1,149	58
Bar	1.2 1.4 1.6	1.7 1.8 1.9	2.0 2.1 2.2	2.3 2.4 2.5	2.6 2.7 2.8	2.8 2.9 3.0	3.1 3.2 3.3	3.4 3.5 3.6	3.7 3.8 3.9	4.0 4.1 4.2			
Psi	17 20 23	25 26 28	29 30 32	33 35 36	38 39 41	42 43 44	45 46 47	48 49 50	51 52 53	54 55 56			
15 km/h Cyc	9765 10885 12000	12245 12490 12730	12975 13220 13465	13705 13950 14350	14750 15150 15550								
40 km/h	6300 7025 7750	7905 8065 8220	8375 8530 8690	8845 9000 9250	9500 9750 10000								

Ø inches	Description	CAI	S mm	OD mm	LR mm	RC mm	Recommended Rim		Acceptable Rim		Tube (Code)	75% internal volume (litres)	Tread depth (mm)
38	IF 900/60 R38 CFO 184A8 TL <i>Textile belted</i>	296920	874	2033	904	6017	DW30B (A)					1,149	58
Bar	1.2 1.4 1.6	1.7 1.8 1.9	2.0 2.1 2.2	2.3 2.4 2.5	2.6 2.7 2.8	2.8 2.9 3.0	3.1 3.2 3.3	3.4 3.5 3.6	3.7 3.8 3.9	4.0 4.1 4.2			
Psi	17 20 23	25 26 28	29 30 32	33 35 36	38 39 41	42 43 44	45 46 47	48 49 50	51 52 53	54 55 56			
15 km/h Cyc	9765 10885 12000	12245 12490 12730	12975 13220 13465	13705 13950									
40 km/h	6300 7025 7750	7905 8065 8220	8375 8530 8690	8845 9000									

Ø inches	Description	CAI	S mm	OD mm	LR mm	RC mm	Recommended Rim		Acceptable Rim		Tube (Code)	75% internal volume (litres)	Tread depth (mm)
38	IF 800/70 R38 CFO 184A8 TL	646846	781	2048	908	6072	DW27B (A)				804	1,088	57
Bar	1.2 1.4 1.6	1.7 1.8 1.9	2.0 2.1 2.2	2.3 2.4 2.5	2.6 2.7 2.8	2.8 2.9 3.0	3.1 3.2 3.3	3.4 3.5 3.6	3.7 3.8 3.9	4.0 4.1 4.2			
Psi	17 20 23	25 26 28	29 30 32	33 35 36	38 39 41	42 43 44	45 46 47	48 49 50	51 52 53	54 55 56			
15 km/h Cyc	9765 10885 12000	12245 12490 12730	12975 13220 13465	13705 13950									
40 km/h	6300 7025 7750	7905 8065 8220	8375 8530 8690	8845 9000									

Ø inches	Description	CAI	S mm	OD mm	LR mm	RC mm	Recommended Rim		Acceptable Rim		Tube (Code)	75% internal volume (litres)	Tread depth (mm)
38	IF 800/70 R38 CFO 187A8 TL	445898	790	2051	912	6079	DW27B (A)				804	1,088	57
Bar	1.2 1.4 1.6	1.7 1.8 1.9	2.0 2.1 2.2	2.3 2.4 2.5	2.6 2.7 2.8	2.8 2.9 3.0	3.1 3.2 3.3	3.4 3.5 3.6	3.7 3.8 3.9	4.0 4.1 4.2			
Psi	17 20 23	25 26 28	29 30 32	33 35 36	38 39 41	42 43 44	45 46 47	48 49 50	51 52 53	54 55 56			
15 km/h Cyc	9765 10885 12000	12245 12490 12730	12975 13220 13465	13705 13950 14240	14530 14820 15110								
40 km/h	6300 7025 7750	7905 8065 8220	8375 8530 8690	8845 9000 9190	9375 9565 9750								

* Refer to the notes at the end of the tables of this range

MICHELIN CEREXBIB

Tyre specifications and pressure table (bar & psi). Load per tyre in kg*

Ø inches	Description	CAI	S mm	OD mm	LR mm	RC mm	Recommended Rim	Acceptable Rim	Tube (Code)	75% internal volume (litres)	Tread depth (mm)
42	VF 520/85 R42 CFO 177A8 TL	934265	541	1953	881	5807	DW18B(A)	DD18 DW18L	802	545	55
Bar	1.2 1.4 1.6	1.7 1.8 1.9	2.0 2.1 2.2	2.3 2.4 2.5	2.6 2.7 2.8	2.8 2.9 3.0	3.1 3.2 3.3	3.4 3.5 3.6	3.7 3.8 3.9	4.0 4.1 4.2	4.3 4.4 4.5
Psi	17 20 23	25 26 28	29 30 32	33 35 36	38 39 41	42 43 44	45 46 47	48 49 50	51 52 53	54 55 56	57 58 59
15 km/h Cyc Dual	5455 5865 6275	6480 6685 6885	7090 7295 7500	7705 7910 8080	8255 8425 8595						
40 km/h	4625 4970 5315	5490 5665 5835	6010 6180 6355	6525 6700 6850	7000 7150 7300						

Ø inches	Description	CAI	S mm	OD mm	LR mm	RC mm	Recommended Rim	Acceptable Rim	Tube (Code)	75% internal volume (litres)	Tread depth (mm)
42	IF 710/70 R42 CFO 182A8 TL	003912	705	2097	942	6230	DW23B (A)		802	872	64
Bar	1.2 1.4 1.6	1.7 1.8 1.9	2.0 2.1 2.2	2.3 2.4 2.5	2.6 2.7 2.8	2.9 3.0 3.1	3.2 3.3 3.4	3.5 3.6 3.7	3.8 3.9 4.0	4.1 4.2 4.3	4.4 4.5 4.6
Psi	17 20 23	25 26 28	29 30 32	33 35 36	38 39 41	42 43 44	45 46 47	48 49 50	51 52 53	54 55 56	57 58 59
15 km/h Cyc	9300 10385 10590	10790 10995 11200	11400 11605 11805	12010 12300 12595	12885 13175 13465						
40 km/h	6000 6700 6830	6965 7095 7225	7355 7490 7620	7750 7940 8125	8315 8500 8685						

***IMPORTANT:**

The inflation pressure must always be appropriate for the load per tyre, the speed of travel and the work to be done. Our recommendations above were correct as of the time of publication of these tables (June 2018). Technical data is subject to change without prior notice.

CEREXBIB tyres carrying the markings IF or VF and CFO have been developed to comply with the experimental ETRTO standard. IF CFO was introduced in 2014 and is currently adopted as a standard. VF CFO has been developed to comply with the experimental ETRTO standard, introduced in 2016 for a period of 4 years, prior to the possible adoption of a new standard. Tyres which meet this new experimental standard must carry the letters IF or VF as a prefix to the size and the letters CFO as a suffix, and tolerate the increase in load indicated in the table above.

Tyres not carrying this special marking cannot tolerate an increase in load in cyclic load conditions.

- For standard or slope correction machines working on slopes of over 20% (11°), increase the usage pressure by 0.5 bar without exceeding the maximum load
- Add 0.4 bar for use on slopes of more than 20%
- Add 0.4 bar for intense road use exceeding 50% of time on road.
- 15 km/h Cyc: Harvesting work with cyclic loads at 15 km/h.
- CFO: Cyclic Field Operation generating a bonus for cyclic loads in the field at 15 km/h. (1.5 km maximum distance fully loaded)



NEW



MICHELIN FLOATXBIB

**THE HIGHEST LOAD
CAPACITY IN THE FIELD
AND HIGHEST SPEED INDEX
ON ROADS**



FOR FLOATERS AND APPLICATORS



EXCELLENT PRODUCTIVITY ⁽¹⁾

- Even pressure distribution across the contact patch
- Improved stubble resistance & wear
- New Innovative tread pattern and new rubber compound providing ULTRAFLEX benefits: low pressure, high load and speed capacity
- 1st IF CFO index E for floater usage
(CFO allows an increased load capacity of 55% when operating under 15 km/h)



SUPPORTS HIGHER YIELDS

- Rounded shoulders enable vegetation protection
- Doubled & reinforced shoulder lugs improve contact patch



DRIVER COMFORT

- Reinforced central area with special lug design

(1) Compared to Michelin MegaXbib. Tests conducted on MICHELIN Tracks Ladoux Centre, in 2016, 2017 & 2018 and Fleet Survey tests with end users from 2015 to 2018

SIZES

IF 1000/55 R32 CFO 191D/188E TL

MICHELIN FLOATXBIB

Tyre specifications and pressure table (bar & psi). Load per tyre in kg*

Ø inches	Description	CAI	S mm	OD mm	LR mm	RC mm	Recommended Rim		Acceptable Rim		Tube (Code)	75% internal volume (litres)	Tread depth (mm)
32	IF 1000/55 R32 CFO 191D/188E TL	564739	1042	1877	825	5549	36.00VA				Joint OR2052	1,177	38
Bar	1.2 1.4 1.6 1.8 2.0 2.2 2.4 2.6 2.8 3.0 3.2												
Psi	17 20 23 26 29 32 35 38 41 44 46												
15 km/h Cyc	9765 10890 12013 12595 13175 13755 14338 14920 15500 16200 16895												
30 km/h Cyc	8190 9135 10075 10565 11050 11540 12025 12515 13000 13585 14170												
65 km/h	6300 7025 7750 8125 8500 8875 9250 9625 10000 10450 10900												
70 km/h	5800 6450 7100 7425 7750 8125 8500 8875 9250 9625 10000												

***IMPORTANT:**

The inflation pressure must always be appropriate for the load per tyre, the speed of travel and the work to be done. Our recommendations above were correct as of the time of publication of these tables (June 2018). Technical data is subject to change without prior notice.

- For standard or slope correction machines working on slopes of over 20% (11°), increase the usage pressure by 0.5 bar without exceeding the maximum load.
- Add 0.4 bar for use on slopes of more than 20%
- Add 0.4 bar for intense road use exceeding 50% of time on road
- 15 km/h Cyc: Harvesting work with cyclic loads at 15 km/h.
- CFO: Cyclic Field Operation generating a bonus for cyclic loads in the field at 15 km/h. (1,5 km maximum distance fully loaded)



MICHELIN MEGAXBIB 2

THE GREAT VALUE TYRE
FOR HARVESTING AND
SPREADING



FOR FLOATERS AND HARVESTERS



ROBUST AND RESISTANT TO STUBBLE

- Reinforced carcass
- Long tyre life



MEGAXBIB RANGE BENEFITS

- Excellent road handling
- High load/speed capacities



NEW MARKING

- Stubble Shield



REINFORCED CARCASS

- Great stability

SIZES

1000/50 R25 172A8/166D TL

750/50 R26 160A8/154D TL

800/65 R32 178A8/178B TL

1050/50 R32 178A8/172D TL

900/60 R32 181A8/181B TL

MICHELIN MEGAXBIB 2

Tyre specifications and pressure table (bar & psi). Load per tyre in kg*

Ø inches	Description	CAI	S mm	OD mm	LR mm	RC mm	Recommended Rim	Acceptable Rim	Tube (Code)	75% internal volume (litres)	Tread depth (mm)				
25	1000/50 R25 172A8/166D TL	852423	1033	1654	732	4907	36.0TH		Joint R1438	892	46				
Bar	1.0	1.3	1.6	1.9	2.2	2.3	2.4	2.5	2.6	2.7	2.8	2.9	3.2	3.5	3.8
Psi	15	19	23	28	32	33	35	36	38	39	41	42	46	51	55
10 km/h Cyc			8290	9005	9725	9960	10200	10330	10455	10585	10710				
30 km/h Cyc			6565	7480	8390	8695	9000	9115	9225	9340	9450				
10 km/h	5815	6940	7740	8385	9025	9235	9450								
30 km/h	4145	4950	5670	6070	6475	6605	6740								
40 km/h	3875	4625	5300	5675	6050	6175	6300								
65 km/h	3255	3885	4450	4765	5080	5185	5290								

Ø inches	Description	CAI	S mm	OD mm	LR mm	RC mm	Recommended Rim	Acceptable Rim	Tube (Code)	75% internal volume (litres)	Tread depth (mm)				
26	750/50 R26 160A8/154D TL	236906	742	1406	629	4171	DW25B (A)			466	39				
Bar	1.0	1.3	1.6	1.9	2.2	2.3	2.4	2.5	2.6	2.7	2.8	2.9	3.2	3.5	3.8
Psi	15	19	23	28	32	33	35	36	38	39	41	42	46	51	55
10 km/h Cyc			5230	5660	6090	6230	6375	6535	6695	6855	7015	7170	7650		
30 km/h Cyc			4200	4735	5270	5445	5625	5765	5910	6050	6190	6330	6750		
10 km/h	3750	4400	5175	5555	5935	6065	6190	6330	6470	6610	6750				
30 km/h	2675	3135	3690	3960	4235	4325	4415	4515	4615	4715	4815				
40 km/h	2500	2930	3450	3705	3955	4040	4125	4220	4310	4405	4500				
65 km/h	2100	2465	2900	3110	3325	3395	3465	3545	3620	3700	3780				

Ø inches	Description	CAI	S mm	OD mm	LR mm	RC mm	Recommended Rim	Acceptable Rim	Tube (Code)	75% internal volume (litres)	Tread depth (mm)				
32	800/65 R32 178A8/178B TL	135425	786	1839	832	5471	DW27B (A)	DH27(B) DW25B(A)	831	871	56				
Bar	1.0	1.3	1.6	1.9	2.2	2.3	2.4	2.5	2.6	2.7	2.8	2.9	3.2	3.5	3.8
Psi	15	19	23	28	32	33	35	36	38	39	41	42	46	51	55
10 km/h Cyc	5865	7080	8290	8880	9470	9665	9860	10075	10285	10500	10710	10915	11525	12140	12750
10 km/h	5175	6060	6940	7600	8260	8480	8700	8890	9075	9265	9450	9630	10170	10710	11250
25 km/h	4440	5165	5885	6300	6720	6855	6995	7160	7330	7495	7660	7825	8325		
30 km/h	4280	4975	5670	6070	6475	6605	6740	6900	7065	7225	7385	7545	8025		
40 km/h	4000	4650	5300	5675	6050	6175	6300	6450	6600	6750	6900	7050	7500		
50 km/h	4000	4650	5300	5675	6050	6175	6300	6450	6600	6750	6900	7050	7500		

* Refer to the notes at the end of the tables of this range

MICHELIN MEGAXBIB 2

Tyre specifications and pressure table (bar & psi). Load per tyre in kg*

Ø inches	Description	CAI	S mm	OD mm	LR mm	RC mm	Recommended Rim		Acceptable Rim		Tube (Code)	75% internal volume (litres)	Tread depth (mm)		
32	1050/50 R32 178A8/172D TL	424273	1037	1866	828	5537	36.00VA				Joint OR2052	1,233	42		
Bar	1.0	1.3	1.6	1.9	2.2	2.3	2.4	2.5	2.6	2.7	2.8	2.9	3.2	3.5	3.8
Psi	15	19	23	28	32	33	35	36	38	39	41	42	46	51	55
10 km/h Cyc			9860	10690	11520	11795	12070	12240	12410	12580	12750				
30 km/h Cyc			7725	8820	9920	10285	10650	10800	10950	11100	11250				
10 km/h	6940	8260	9450	10125	10800	11025	11250								
30 km/h	4950	5890	6740	7220	7705	7865	8025								
40 km/h	4625	5505	6300	6750	7200	7350	7500								
65 km/h	3885	4625	5290	5670	6050	6175	6300								

Ø inches	Description	CAI	S mm	OD mm	LR mm	RC mm	Recommended Rim		Acceptable Rim		Tube (Code)	75% internal volume (litres)	Tread depth (mm)		
32	900/60 R32 181A8/181B TL	166896	862	1899	848	5635	DW27B (A)		DW30B(A)		831	1,033	57		
Bar	1.0	1.3	1.6	1.9	2.2	2.3	2.4	2.5	2.6	2.7	2.8	2.9	3.2	3.5	3.8
Psi	15	19	23	28	32	33	35	36	38	39	41	42	46	51	55
10 km/h Cyc	6375	7695	9010	9775	10540	10795	11050	11305	11560	11815	12070	12265	12850	13440	14025
10 km/h	5625	6675	7725	8485	9245	9495	9750	9975	10200	10425	10650	10825	11340	11860	12375
25 km/h	4720	5580	6440	6980	7520	7700	7880	8060	8245	8425	8605	8745	9160		
30 km/h	4550	5380	6205	6725	7250	7420	7595	7770	7945	8120	8295	8430	8830		
40 km/h	4250	5025	5800	6290	6775	6940	7100	7265	7425	7590	7750	7875	8250		
50 km/h	4250	5025	5800	6290	6775	6940	7100	7265	7425	7590	7750	7875	8250		

***IMPORTANT:**

The inflation pressure must always be appropriate for the load per tyre, the speed of travel and the work to be done. Our recommendations above were correct as of the time of publication of these tables (June 2018). Technical data is subject to change without prior notice.

- For standard or slope correction machines working on slopes of over 20% (11°), use the 10 km/h non-cyclic curve
- For harvesters, use 10 km/h non-cyclic table and the 30 km/h non-cyclic table for floaters.
- Add 0.4 bar for use on slopes of more than 20%
- Add 0.4 bar for intense road use exceeding 50% of time on road
- 10 km/h or 30 km/h cyclic load, use in the field only, travel with full load not to exceed 1,5 km.



MICHELIN MEGAXBIB

**EXCELLENT VALUE
FOR HARVESTERS
& HEAVY EQUIPMENT**



For **harvesting machines**



LOAD CAPACITY

- Up to 30 600 kg⁽¹⁾ per axle



ENDURANCE

- Up to +46%⁽²⁾ vs main competitor



COMFORT



STEEL CROWN BELTS

- Great stability
- Excellent puncture resistance and load distribution.

(1) 1050/50 R32 184A8/184B - 6 mph cyc. (2) Internal test (Ladoux - France) study on 800/65R32 178A8/178B compared with MITAS 800/65R32 178A8

SIZES

620/75 R26 166A8/166B TL
750/65 R26 171A8/171B TL
620/75 R30 168A8/168B TL
650/75 R32 172A8/172B TL
800/65 R32 178A8/178B TL
1050/50 R32 184A8/184B TL T2

900/60 R32 181A8/181B TL
1050/50 R32 178A8 TL M28
800/70 R32 181A8/181B TL
620/75 R34 170A8/170B TL
710/75 R34 178A8/178B TL
620/70 R38 170A8/170B TL

650/85 R38 173A8/173B TL
520/85 R42 162A8/162B TL
620/70 R42 166A8/166B TL

MICHELIN MEGAXBIB

Tyre specifications and pressure table (bar & psi). Load per tyre in kg*

Ø inches	Description	CAI	S mm	OD mm	LR mm	RC mm	Recommended Rim		Acceptable Rim		Tube (Code)	75% internal volume (litres)	Tread depth (mm)		
26	620/75 R26 166A8/166B TL	614320	588	1602	712	4748	DW20B (A)		DW18L		830	516	46		
Bar	1.0	1.3	1.6	1.9	2.2	2.3	2.4	2.5	2.6	2.7	2.8	2.9	3.2	3.5	3.8
Psi	15	19	23	28	32	33	35	36	38	39	41	42	46	51	55
10 km/h Cyc	4410	4820	5230	5745	6260	6435	6605	6775	6950	7120	7290	7465	7980	8495	9010
10 km/h	3910	4405	4900	5315	5730	5870	6010	6150	6285	6425	6565	6700	7120	7535	7950
25 km/h	3170	3610	4050	4395	4735	4850	4965	5080	5195	5310	5425	5535	5880		
30 km/h	3060	3480	3900	4230	4565	4675	4785	4895	5005	5115	5230	5340	5670		
40 km/h	2860	3250	3640	3950	4265	4365	4470	4575	4680	4780	4885	4990	5300		
50 km/h	2860	3250	3640	3950	4265	4365	4470	4575	4680	4780	4885	4990	5300		

Ø inches	Description	CAI	S mm	OD mm	LR mm	RC mm	Recommended Rim		Acceptable Rim		Tube (Code)	75% internal volume (litres)	Tread depth (mm)		
26	750/65 R26 171A8/171B TL	983217	732	1621	730	4818	DW25B (A)				833	677	46		
Bar	1.0	1.3	1.6	1.9	2.2	2.3	2.4	2.5	2.6	2.7	2.8	2.9	3.2	3.5	3.8
Psi	15	19	23	28	32	33	35	36	38	39	41	42	46	51	55
10 km/h Cyc	4930	5865	6675	7360	7920	8100	8285	8470	8650	8815	8975	9140	9590	10020	10455
10 km/h	4350	5080	5760	6380	6940	7110	7285	7460	7630	7775	7920	8060	8460	8845	9225
25 km/h	3610	4175	4735	5240	5630	5765	5895	6030	6160	6270	6380	6495	6825		
30 km/h	3480	4025	4570	5055	5420	5550	5680	5810	5940	6045	6155	6260	6580		
40 km/h	3250	3760	4265	4720	5070	5190	5310	5430	5550	5650	5750	5850	6150		
50 km/h	3250	3760	4265	4720	5070	5190	5310	5430	5550	5650	5750	5850	6150		

Ø inches	Description	CAI	S mm	OD mm	LR mm	RC mm	Recommended Rim		Acceptable Rim		Tube (Code)	75% internal volume (litres)	Tread depth (mm)		
30	620/75 R30 168A8/168B TL	753673	604	1710	770	5083	DW20B (A)		DW18L		737	559	46		
Bar	1.0	1.3	1.6	1.9	2.2	2.3	2.4	2.5	2.6	2.7	2.8	2.9	3.2	3.5	3.8
Psi	15	19	23	28	32	33	35	36	38	39	41	42	46	51	55
10 km/h Cyc	4660	5090	5520	6065	6610	6795	6975	7155	7340	7520	7700	7885	8430	8975	9520
10 km/h	4130	4650	5170	5610	6050	6200	6345	6490	6640	6785	6930	7080	7520	7960	8400
25 km/h	3360	3815	4270	4635	5000	5120	5240	5360	5485	5605	5725	5845	6210		
30 km/h	3240	3680	4120	4470	4820	4940	5055	5170	5290	5405	5525	5640	5990		
40 km/h	3030	3440	3850	4180	4505	4615	4725	4835	4945	5055	5165	5270	5600		
50 km/h	3030	3440	3850	4180	4505	4615	4725	4835	4945	5055	5165	5270	5600		

* Refer to the notes at the end of the tables of this range

MICHELIN MEGAXBIB

Tyre specifications and pressure table (bar & psi). Load per tyre in kg*

Ø inches	Description	CAI	S mm	OD mm	LR mm	RC mm	Recommended Rim		Acceptable Rim	Tube (Code)	75% internal volume (litres)	Tread depth (mm)			
32	650/75 R32 172A8/172B TL	468227	657	1825	821	5423	DW21B (A)		DW20B (A) DW23B (A)	831	698	59			
Bar	1.0	1.3	1.6	1.9	2.2	2.3	2.4	2.5	2.6	2.7	2.8	2.9	3.2	3.5	3.8
Psi	15	19	23	28	32	33	35	36	38	39	41	42	46	51	55
10 km/h Cyc	4900	5710	6520	7090	7665	7855	8045	8235	8425	8615	8805	8995	9565	10140	10710
10 km/h	4500	5220	5940	6420	6895	7055	7215	7375	7535	7695	7855	8015	8495	8970	9450
25 km/h	3630	4235	4840	5245	5645	5780	5915	6050	6185	6320	6455	6585	6990		
30 km/h	3500	4085	4670	5060	5445	5575	5705	5835	5965	6095	6225	6350	6740		
40 km/h	3280	3820	4360	4725	5090	5210	5330	5450	5575	5695	5815	5935	6300		
50 km/h	3280	3820	4360	4725	5090	5210	5330	5450	5575	5695	5815	5935	6300		

Ø inches	Description	CAI	S mm	OD mm	LR mm	RC mm	Recommended Rim		Acceptable Rim	Tube (Code)	75% internal volume (litres)	Tread depth (mm)			
32	800/65 R32 178A8/178B TL	521809	793	1840	822	5459	DW27B (A)		DHB27 DW25B (A)	831	903	56			
Bar	1.0	1.3	1.6	1.9	2.2	2.3	2.4	2.5	2.6	2.7	2.8	2.9	3.2	3.5	3.8
Psi	15	19	23	28	32	33	35	36	38	39	41	42	46	51	55
10 km/h Cyc	5865	7080	8290	8880	9470	9665	9860	10075	10285	10500	10710	10915	11525	12140	12750
10 km/h	5175	6060	6940	7600	8260	8480	8700	8890	9075	9265	9450	9630	10170	10710	11250
25 km/h	4440	5165	5885	6300	6720	6855	6995	7160	7330	7495	7660	7825	8325		
30 km/h	4280	4975	5670	6070	6475	6605	6740	6900	7065	7225	7385	7545	8025		
40 km/h	4000	4650	5300	5675	6050	6175	6300	6450	6600	6750	6900	7050	7500		
50 km/h	4000	4650	5300	5675	6050	6175	6300	6450	6600	6750	6900	7050	7500		

Ø inches	Description	CAI	S mm	OD mm	LR mm	RC mm	Recommended Rim		Acceptable Rim	Tube (Code)	75% internal volume (litres)	Tread depth (mm)			
32	1050/50 R32 184A8/184B TL T2 <i>Tyre for spreading machinery</i>	829536	1040	1856	831	5510	36.00VA			Joint OR2052	1,159	41			
Bar	1.0	1.3	1.6	1.9	2.2	2.3	2.4	2.5	2.6	2.7	2.8	2.9	3.2	3.5	3.8
Psi	15	19	23	28	32	33	35	36	38	39	41	42	46	51	55
10 km/h Cyc	6800	8330	9860	10710	11475	11730	11985	12240	12495	12750	13005	13260	14025	14665	15300
30 km/h Cyc	6240	7370	8500	9045	9695	9910	10125	10380	10630	10885	11140	11390	12150	12825	13500
25 km/h	5135	6065	6995	7495	7995	8160	8325	8535	8745	8950	9160	9370	9990		
30 km/h	4950	5845	6740	7220	7705	7865	8025	8225	8430	8630	8830	9030	9630		
40 km/h	4625	5465	6300	6750	7200	7350	7500	7690	7875	8065	8250	8440	9000		
50 km/h	4625	5465	6300	6750	7200	7350	7500	7690	7875	8065	8250	8440	9000		

* Refer to the notes at the end of the tables of this range

MICHELIN MEGAXBIB

Tyre specifications and pressure table (bar & psi). Load per tyre in kg*

Ø inches	Description	CAI	S mm	OD mm	LR mm	RC mm	Recommended Rim		Acceptable Rim		Tube (Code)	75% internal volume (litres)	Tread depth (mm)		
32	900/60 R32 181A8/181B TL	824122	868	1894	850	5626	DW27B (A)		DW30B (A)		831	1,033	56		
Bar	1.0	1.3	1.6	1.9	2.2	2.3	2.4	2.5	2.6	2.7	2.8	2.9	3.2	3.5	3.8
Psi	15	19	23	28	32	33	35	36	38	39	41	42	46	51	55
10 km/h Cyc	6375	7695	9010	9775	10540	10795	11050	11305	11560	11815	12070	12265	12850	13440	14025
10 km/h	5625	6675	7725	8485	9245	9495	9750	9975	10200	10425	10650	10825	11340	11860	12375
25 km/h	4720	5580	6440	6980	7520	7700	7880	8060	8245	8425	8605	8745	9160		
30 km/h	4550	5380	6205	6725	7250	7420	7595	7770	7945	8120	8295	8430	8830		
50 km/h	4250	5025	5800	6290	6775	6940	7100	7265	7425	7590	7750	7875	8250		

Ø inches	Description	CAI	S mm	OD mm	LR mm	RC mm	Recommended Rim		Acceptable Rim		Tube (Code)	75% internal volume (litres)	Tread depth (mm)		
32	1050/50 R32 178A8 TL M28 <i>Tyre for harvesting machinery</i>	236234	1038	1902	854	5649	36.00VA				Joint OR2052	1,250	60		
Bar	1.0	1.3	1.6	1.9	2.2	2.3	2.4	2.5	2.6	2.7	2.8	2.9	3.2	3.5	3.8
Psi	15	19	23	28	32	33	35	36	38	39	41	42	46	51	55
10 km/h Cyc	7420	8630	9840	10635	11425	11690	11955	12220	12485	12750					
15 km/h Cyc	5350	6675	8000	9330	10390	10700	11010	11165	11320	11475	11630				
10 km/h	6860	7925	8990	9605	10225	10430	10635	10840	11045	11250					
25 km/h	5570	6505	7440	7775	8110	8220	8330								
30 km/h	5370	6270	7170	7495	7815	7925	8030								
40 km/h	5020	5860	6700	7000	7300	7400	7500								

Ø inches	Description	CAI	S mm	OD mm	LR mm	RC mm	Recommended Rim		Acceptable Rim		Tube (Code)	75% internal volume (litres)	Tread depth (mm)		
32	800/70 R32 181A8/181B TL	695992	793	1936	871	5725	DW27B (A)		DW25B (A)		831	966	58		
Bar	1.0	1.3	1.6	1.9	2.2	2.3	2.4	2.5	2.6	2.7	2.8	2.9	3.2	3.5	3.8
Psi	15	19	23	28	32	33	35	36	38	39	41	42	46	51	55
10 km/h Cyc	6375	7820	9265	9965	10625	10840	11050	11220	11390	11560	11730	11960	12650	13335	14025
10 km/h	5625	6675	7725	8830	9475	9615	9750	9900	10050	10200	10350	10555	11160	11770	12375
20 km/h	5335	6360	7380	7795	8210	8345	8485	8695	8900	9110	9320	9525	10150		
25 km/h	4815	5740	6660	7035	7410	7535	7660	7850	8035	8225	8410	8600	9160		
30 km/h	4680	5550	6420	6780	7140	7260	7380	7560	7745	7925	8105	8285	8830		
40 km/h	4375	5190	6000	6340	6675	6790	6900	7070	7240	7405	7575	7745	8250		

* Refer to the notes at the end of the tables of this range

MICHELIN MEGAXBIB

Tyre specifications and pressure table (bar & psi). Load per tyre in kg*

Ø inches	Description	CAI	S mm	OD mm	LR mm	RC mm	Recommended Rim		Acceptable Rim		Tube (Code)	75% internal volume (litres)	Tread depth (mm)		
34	620/75 R34 170A8/170B TL	325025	590	1814	821	5398	DW20B (A)		DW18L			612	46		
Bar	1.0	1.3	1.6	1.9	2.2	2.3	2.4	2.5	2.6	2.7	2.8	2.9	3.2	3.5	3.8
Psi	15	19	23	28	32	33	35	36	38	39	41	42	46	51	55
10 km/h Cyc	5010	5565	6120	6680	7235	7420	7605	7790	7975	8160	8345	8530	9090	9645	10200
10 km/h	4560	5035	5510	5985	6465	6620	6780	6940	7095	7255	7415	7575	8050	8525	9000
25 km/h	3710	4110	4515	4915	5320	5455	5585	5720	5855	5990	6125	6260	6660		
30 km/h	3580	3965	4355	4740	5130	5260	5385	5515	5645	5775	5905	6035	6420		
40 km/h	3350	3710	4075	4435	4795	4915	5035	5155	5275	5400	5520	5640	6000		
50 km/h	3350	3710	4075	4435	4795	4915	5035	5155	5275	5400	5520	5640	6000		

Ø inches	Description	CAI	S mm	OD mm	LR mm	RC mm	Recommended Rim		Acceptable Rim		Tube (Code)	75% internal volume (litres)	Tread depth (mm)		
34	710/75 R34 178A8/178B TL	543107	690	1900	848	5637	DW23B (A)		DW21B (A) MW23B (A)		765	863	58		
Bar	1.0	1.3	1.6	1.9	2.2	2.3	2.4	2.5	2.6	2.7	2.8	2.9	3.2	3.5	3.8
Psi	15	19	23	28	32	33	35	36	38	39	41	42	46	51	55
10 km/h Cyc	6260	6955	7650	8345	9040	9275	9505	9735	9970	10200	10430	10665	11360	12055	12750
10 km/h	5700	6295	6890	7485	8080	8275	8475	8675	8870	9070	9270	9465	10060	10655	11250
25 km/h	4650	5150	5655	6155	6655	6825	6990	7160	7325	7495	7660	7830	8330		
30 km/h	4480	4965	5450	5930	6415	6580	6740	6900	7060	7225	7385	7545	8030		
40 km/h	4190	4640	5095	5545	5995	6145	6295	6445	6595	6750	6900	7050	7500		
50 km/h	4190	4640	5095	5545	5995	6145	6295	6445	6595	6750	6900	7050	7500		

Ø inches	Description	CAI	S mm	OD mm	LR mm	RC mm	Recommended Rim		Acceptable Rim		Tube (Code)	75% internal volume (litres)	Tread depth (mm)		
38	620/70 R38 170A8/170B TL	476088	608	1864	850	5557	DW20B (A)		DW18L		825	587	55		
Bar	1.0	1.3	1.6	1.9	2.2	2.3	2.4	2.5	2.6	2.7	2.8	2.9	3.2	3.5	3.8
Psi	15	19	23	28	32	33	35	36	38	39	41	42	46	51	55
10 km/h Cyc	5010	5565	6120	6680	7235	7420	7605	7790	7975	8160	8345	8530	9090	9645	10200
10 km/h	4560	5035	5510	5985	6465	6620	6780	6940	7095	7255	7415	7575	8050	8525	9000
25 km/h	3710	4110	4515	4915	5320	5455	5585	5720	5855	5990	6125	6260	6660		
30 km/h	3580	3965	4355	4740	5130	5260	5385	5515	5645	5775	5905	6035	6420		
40 km/h	3350	3710	4075	4435	4795	4915	5035	5155	5275	5400	5520	5640	6000		
50 km/h	3350	3710	4075	4435	4795	4915	5035	5155	5275	5400	5520	5640	6000		

* Refer to the notes at the end of the tables of this range

MICHELIN MEGAXBIB

Tyre specifications and pressure table (bar & psi). Load per tyre in kg*

Ø inches	Description	CAI	S mm	OD mm	LR mm	RC mm	Recommended Rim		Acceptable Rim		Tube (Code)	75% internal volume (litres)	Tread depth (mm)
38	650/85 R38 173A8/173B TL <i>Textile belted</i>	173491	699	2048	931	6100	DW23B (A)				804	857	63
Bar	1.0 1.3 1.6	1.9 2.2 2.3	2.4 2.5 2.6	2.7 2.8	2.9 3.2 3.5	3.8							3.8
Psi	15 19 23	28 32 33	35 36 38	39 41	42 46 51	55							
10 km/h Cyc Dual	5610 6545 7480	8040 8600 8790	8975 9165 9350	9535 9724									
10 km/h	5815 6660 7500	8065 8625 8815	9000 9190 9375	9565 9750									
25 km/h	4440 5245 6050	6485 6925 7070	7215										
30 km/h	4280 5055 5830	6250 6675 6815	6955										
40 km/h	4000 4725 5450	5845 6240 6370	6500										
50 km/h	4000 4725 5450	5845 6240 6370	6500										

Ø inches	Description	CAI	S mm	OD mm	LR mm	RC mm	Recommended Rim		Acceptable Rim		Tube (Code)	75% internal volume (litres)	Tread depth (mm)
42	520/85 R42 162A8/162B TL <i>Textile belted</i>	645194	537	1937	889	5783	DW18L		DD18 W18L		802	545	56
Bar	1.0 1.3 1.6	1.9 2.2 2.3	2.4 2.5 2.6	2.7 2.8	2.9 3.2 3.5	3.8							3.8
Psi	15 19 23	28 32 33	35 36 38	39 41	42 46 51	55							
10 km/h Cyc Dual	3850 4575 5300	6170 6500 6620	6740 6865 6985	7105									
10 km/h	3990 4900 5810	6395 6830 6975	7070 7170 7265	7360									
25 km/h	3330 3955 4580	4890 5135 5205	5275										
30 km/h	3210 3815 4415	4715 4950 5020	5085										
50 km/h	3000 3565 4125	4405 4625 4690	4750										
30 km/h Dual	2825 3355 3885	4150 4355 4415	4475										

Ø inches	Description	CAI	S mm	OD mm	LR mm	RC mm	Recommended Rim		Acceptable Rim		Tube (Code)	75% internal volume (litres)	Tread depth (mm)
42	620/70 R42 166A8/166B TL <i>Textile belted</i>	100268	639	1961	885	5857	DW20B (A)		DW18L MW20B (A)		802	658	56
Bar	1.0 1.3 1.6	1.9 2.2 2.3	2.4 2.5 2.6	2.7 2.8	2.9 3.2 3.5	3.8							3.8
Psi	15 19 23	28 32 33	35 36 38	39 41	42 46 51	55							
10 km/h Cyc Dual	4080 4875 5670	6465 7030 7180	7330 7480 7630	7780 7930									
10 km/h	4090 4890 5685	6485 7050 7200	7350 7500 7650	7800 7950									
40 km/h	3250 3875 4500	4800 5100 5200	5300										
50 km/h	3250 3875 4500	4800 5100 5200	5300										
30 km/h Dual	3060 3650 4240	4520 4805 4895	4990										

***IMPORTANT:**

The inflation pressure must always be appropriate for the load per tyre, the speed of travel and the work to be done. Our recommendations above were correct as of the time of publication of these tables (June 2018). Technical data is subject to change without prior notice.

- For standard or slope correction machines working on slopes of over 20% (11°), use the 10 km/h non-cyclic curve
- Add 0.4 bar for use on slopes of more than 20%
- Add 0.4 bar for intense road use exceeding 50% of time on road
- 10, 15 or 30 km/h cyclic load, use in the field only, travel with full load not to exceed 1,5 km.



MICHELIN SPRAYBIB

**HIGH LOAD CAPACITY
FOR SPRAYERS**



FOR **SPRAYERS AND ROW CROP APPLICATIONS**



VERY HIGH FLEXION (VF)



PRODUCTIVITY

- +16%⁽¹⁾ load vs IF tyre at the same pressure



SOIL PROTECTION

- 25%⁽¹⁾ lower air pressure for the same load as an IF tyre



COMFORT

- Excellent stability at high speeds (up to 65 km/h)

(1) Internal test 2015 (Ladoux – France)

SIZES

VF 380/80 R38 167D TL **NEW**

VF 320/90 R42 163D TL **NEW**

VF 480/80 R42 176D TL

VF 380/90 R46 173D TL

VF 480/80 R46 177D TL

VF 320/90 R50 166D TL **NEW**

VF 380/90 R50 175D TL

VF 480/80 R50 179D TL

VF 420/95 R50 177D TL

VF 320/90 R54 168D TL **NEW**

VF 380/90 R54 176D TL

MICHELIN SPRAYBIB

Tyre specifications and pressure table (bar & psi). Load per tyre in kg*

Ø inches	Description	CAI	S mm	OD mm	LR mm	RC mm	Recommended Rim		Acceptable Rim		Tube (Code)	75% internal volume (litres)	Tread depth (mm)	
38	VF 380/80 R38 167D TL NEW	352109	382	1577	726	4712	DW13		DW12		795	231	38	
Bar	1.8 2.0 2.2 2.4 2.6 2.8 3.0 3.2 3.4	3.5 3.75 4.0 4.25 4.5 4.75 5.0 5.25 5.5	3940 4125 4315 4500 4625	4750 4875	5000	5225 5450								
Psi	26 29 32 35 38 41 44 46 49	52 55 58 61 64												
65 km/h		3650	3750	3940	4125	4315	4500	4625	4750	4875	5000	5225	5450	

Ø inches	Description	CAI	S mm	OD mm	LR mm	RC mm	Recommended Rim		Acceptable Rim		Tube (Code)	75% internal volume (litres)	Tread depth (mm)	
42	VF 320/90 R42 163D TL NEW	920383	322	1634	758	4890	DW11		DW10			195	36	
Bar	1.8 2.0 2.2 2.4 2.6 2.8 3.0 3.2 3.4	3.5 3.75 4.0 4.25 4.5 4.75 5.0 5.25 5.5	3500 3650 3825	4000 4125	4250 4405	4565 4720 4875								
Psi	26 29 32 35 38 41 44 46 49	52 55 58 61 64												
65 km/h		3250	3350	3500	3650	3825	4000	4125	4250	4405	4565	4720	4875	

Ø inches	Description	CAI	S mm	OD mm	LR mm	RC mm	Recommended Rim		Acceptable Rim		Tube (Code)	75% internal volume (litres)	Tread depth (mm)	
42	VF 480/80 R42 176D TL	929553	489	1838	833	5471	DW16A		DD16 W16A		801	420	38	
Bar	1.8 2.0 2.2 2.4 2.6 2.8 3.0 3.2 3.4	3.5 3.75 4.0 4.25 4.5 4.75 5.0 5.25 5.5	5875 6150 6425	6700 6900	7100									
Psi	26 29 32 35 38 41 44 46 49	52 55 58 61 64												
65 km/h		5000	5200	5400	5600	5875	6150	6425	6700	6900	7100			

Ø inches	Description	CAI	S mm	OD mm	LR mm	RC mm	Recommended Rim		Acceptable Rim		Tube (Code)	75% internal volume (litres)	Tread depth (mm)	
46	VF 380/90 R46 173D TL	198604	383	1842	848	5530	DW13A		DW12A W12 W12A W13 W13A		835	308	38	
Bar	1.8 2.0 2.2 2.4 2.6 2.8 3.0 3.2 3.4	3.5 3.75 4.0 4.25 4.5 4.75 5.0 5.25 5.5	4815 5000 5225	5450 5625	5800 5900	6250 6500								
Psi	26 29 32 35 38 41 44 46 49	52 55 58 61 64												
65 km/h		4375	4625	4815	5000	5225	5450	5625	5800	5900	6000	6250	6500	

Ø inches	Description	CAI	S mm	OD mm	LR mm	RC mm	Recommended Rim		Acceptable Rim		Tube (Code)	75% internal volume (litres)	Tread depth (mm)	
46	VF 480/90 R46 177D TL	159186	485	1943	885	5790	DW16A (L)		DW15L DW16B W16A		834	449	38	
Bar	1.8 2.0 2.2 2.4 2.6 2.8 3.0 3.2 3.4	3.5 3.75 4.0 4.25 4.5 4.75 5.0 5.25 5.5	6075 6350 6625	6900 7100	7300									
Psi	26 29 32 35 38 41 44 46 49	52 55 58 61 64												
65 km/h		5300	5465	5635	5800	6075	6350	6625	6900	7100	7300			

* Refer to the notes at the end of the tables of this range

MICHELIN SPRAYBIB

Tyre specifications and pressure table (bar & psi). Load per tyre in kg*

Ø inches	Description	CAI	S mm	OD mm	LR mm	RC mm	Recommended Rim		Acceptable Rim	Tube (Code)	75% internal volume (litres)	Tread depth (mm)	
50	VF 320/90 R50 166D TL NEW	946508	320	1850	866	5682	DW11		DW10 W10 W11	816	209	36	
Bar	1.8 2.0 2.2 2.4 2.6 2.8 3.0 3.2 3.4	3.6 3.8	4.0 4.2 4.4										
Psi	26 29 32 35 38 41 44 46 49	52 55	58 61 64										
65 km/h		3650	3750	3875	4000	4190	4375	4500	4625	4795	4965	5130	5300

Ø inches	Description	CAI	S mm	OD mm	LR mm	RC mm	Recommended Rim		Acceptable Rim	Tube (Code)	75% internal volume (litres)	Tread depth (mm)	
50	VF 380/90 R50 175D TL	722276	384	1951	903	5836	DW13B		DW12A W12A W12B W13A W13B		329	38	
Bar	1.8 2.0 2.2 2.4 2.6 2.8 3.0 3.2 3.4	3.6 3.8	4.0 4.2 4.4										
Psi	26 29 32 35 38 41 44 46 49	52 55	58 61 64										
65 km/h		4625	4750	4950	5150	5375	5600	5800	6000	6150	6300	6600	6900

Ø inches	Description	CAI	S mm	OD mm	LR mm	RC mm	Recommended Rim		Acceptable Rim	Tube (Code)	75% internal volume (litres)	Tread depth (mm)	
50	VF 480/80 R50 179D TL	431251	485	2045	935	6101	DW16A(L)		DW15B (A) DW15L DW16B W15B (A) W16B		479	38	
Bar	1.8 2.0 2.2 2.4 2.6 2.8 3.0 3.2 3.4	3.6 3.8	4.0 4.2 4.4										
Psi	26 29 32 35 38 41 44 46 49	52 55	58 61 64										
65 km/h		5450	5685	5915	6150	6440	6725	7015	7300	7525	7750		

Ø inches	Description	CAI	S mm	OD mm	LR mm	RC mm	Recommended Rim		Acceptable Rim	Tube (Code)	75% internal volume (litres)	Tread depth (mm)	
50	VF 420/95 R50 177D TL	085405	423	2052	937	6118	DW14B (A)		DW13B (A) W13B (A) W14B (A)		440	38	
Bar	1.8 2.0 2.2 2.4 2.6 2.8 3.0 3.2 3.4	3.6 3.8	4.0 4.2 4.4										
Psi	26 29 32 35 38 41 44 46 49	52 55	58 61 64										
65 km/h		5150	5365	5585	5800	6075	6350	6625	6900	7100	7300		

Ø inches	Description	CAI	S mm	OD mm	LR mm	RC mm	Recommended Rim		Acceptable Rim	Tube (Code)	75% internal volume (litres)	Tread depth (mm)	
54	VF 320/90 R54 168D TL NEW	044008	323	1950	914	5851	DW11		DW10 W10 W11	816	240	36	
Bar	1.8 2.0 2.2 2.4 2.6 2.8 3.0 3.2 3.4	3.6 3.8	4.0 4.2 4.4										
Psi	26 29 32 35 38 41 44 46 49	52 55	58 61 64										
65 km/h		3750	3875	4065	4250	4440	4625	4750	4875	5055	5240	5420	5600

* Refer to the notes at the end of the tables of this range

MICHELIN SPRAYBIB

Tyre specifications and pressure table (bar & psi). Load per tyre in kg*

Ø inches	Description	CAI	S mm	OD mm	LR mm	RC mm	Recommended Rim		Acceptable Rim		Tube (Code)	75% internal volume (litres)	Tread depth (mm)
54	VF 380/90 R54 176D TL	816598	384	2049	950	6131	DW13A		W12A			350	37
Bar	1.8 2.0 2.2	2.4	2.6	2.8	3.0	3.2	3.4	3.6	3.8	4.0	4.2	4.4	
Psi	26 29 32	35	38	41	44	46	49	52	55	58	61	64	
65 km/h		4875	5000	5190	5375	5565	5750	5940	6125	6315	6500	6800	7100

***IMPORTANT:**

The inflation pressure must always be appropriate for the load per tyre, the speed of travel and the work to be done. Our recommendations above were correct as of the time of publication of these tables (June 2018). Technical data is subject to change without prior notice.

- For use on side slopes: add 0.4 bar.
- For heavy road use, add 0.4 bar.



MICHELIN AGRIBIB ROW CROP

*SPECIALLY DESIGNED FOR
ROW CROP WORK WITH
EXCELLENT TRACTION*



FOR ROW CROP TRACTORS AND IMPLEMENTS



TRACTION

- Lug design aids traction in the field



CROP PROTECTION

- Rounded shoulders help protect crops

SIZES

320/85 R38 143A8/143B TL

320/90 R42 147A8/147B TL

340/85 R46 150A8/150B TL

380/90 R46 157A8/157B TL

320/90 R50 150A8/150B TL

380/90 R50 151A8/151B TL

320/90 R54 151A8/151B TL

MICHELIN AGRIBIB ROW CROP

Tyre specifications and pressure table (bar & psi). Load per tyre in kg*

Ø inches	Description	CAI	S mm	OD mm	LR mm	RC mm	Recommended Rim		Acceptable Rim		Tube (Code)	75% internal volume (litres)	Tread depth (mm)		
38	320/85 R38 143A8/143B TL (12.4 R38)	758001	315	1508	699	4514	W10		DW10A DW11A W11		779	170	42		
Bar	1.2	1.4	1.6	1.8	2.0	2.2	2.4	2.6	2.8	3.0	3.2	3.4	3.6	3.8	4.0
Psi	17	20	23	26	29	32	35	38	41	44	46	49	52	55	58
10 km/h Cyc			2330	2520	2710	2900	3090	3205	3315	3430	3540	3700	3860	3975	4090
25 km/h Cyc	1890	2075	2260	2360	2460	2560	2660	2780	2900	3020	3140	3230	3320		
30 km/h Cyc	1770	1940	2110	2205	2300	2395	2490	2605	2715	2830	2940	3025	3110		
25 km/h	1720	1885	2050	2145	2235	2330	2420	2530	2640	2750	2860	2940	3020		
30 km/h	1660	1820	1980	2070	2155	2245	2330	2440	2545	2655	2760	2840	2920		
50 km/h	1550	1700	1850	1935	2015	2100	2180	2280	2380	2475	2575	2650	2725		

Ø inches	Description	CAI	S mm	OD mm	LR mm	RC mm	Recommended Rim		Acceptable Rim		Tube (Code)	75% internal volume (litres)	Tread depth (mm)		
42	320/90 R42 147A8/147B TL	425361	312	1638	764	4908	DW10L		W10L W9L			197	42		
Bar	1.2	1.4	1.6	1.8	2.0	2.2	2.4	2.6	2.8	3.0	3.2	3.4	3.6	3.8	4.0
Psi	17	20	23	26	29	32	35	38	41	44	46	49	52	55	58
10 km/h Cyc			2850	3025	3195	3370	3540	3650	3760	3865	3975	4165	4350	4480	4610
25 km/h Cyc	2075	2295	2510	2625	2740	2850	2965	3110	3255	3395	3540	3645	3750		
30 km/h Cyc	1940	2225	2510	2575	2640	2705	2770	2905	3040	3170	3305	3405	3505		
25 km/h	1890	2090	2290	2395	2495	2600	2700	2830	2960	3090	3220	3320	3415		
30 km/h	1820	2010	2200	2300	2400	2500	2600	2725	2850	2975	3100	3195	3290		
50 km/h	1700	1880	2060	2155	2245	2340	2430	2550	2665	2785	2900	2990	3075		

Ø inches	Description	CAI	S mm	OD mm	LR mm	RC mm	Recommended Rim		Acceptable Rim		Tube (Code)	75% internal volume (litres)	Tread depth (mm)		
46	340/85 R46 150A8/150B TL (13.6 R46)	846786	338	1747	810	5227	W12		DW10A W10 W12A		835	225	41		
Bar	1.2	1.4	1.6	1.8	2.0	2.2	2.4	2.6	2.8	3.0	3.2	3.4	3.6	3.8	4.0
Psi	17	20	23	26	29	32	35	38	41	44	46	49	52	55	58
10 km/h Cyc			2780	3025	3265	3510	3750	3900	4050	4200	4350	4540	4730	4880	5030
25 km/h Cyc	2260	2495	2730	2855	2980	3105	3230	3385	3535	3690	3840	3965	4090		
30 km/h Cyc	2110	2330	2550	2670	2785	2905	3020	3165	3305	3450	3590	3705	3820		
25 km/h	2050	2270	2490	2605	2715	2830	2940	3080	3220	3360	3500	3610	3720		
30 km/h	1980	2190	2400	2510	2620	2730	2840	2975	3105	3240	3370	3475	3580		
50 km/h	1850	2045	2240	2345	2445	2550	2650	2775	2900	3025	3150	3250	3350		

* Refer to the notes at the end of the tables of this range

MICHELIN AGRIBIB ROW CROP

Tyre specifications and pressure table (bar & psi). Load per tyre in kg*

Ø inches	Description	CAI	S mm	OD mm	LR mm	RC mm	Recommended Rim		Acceptable Rim			Tube (Code)	75% internal volume (litres)	Tread depth (mm)	
46	380/90 R46 157A8/157B TL (14.9 R46)	799905	401	1864	867	5583	W13A		DW13 W12	DW13A W13	835	308	46		
Bar	1.2	1.4	1.6	1.8	2.0	2.2	2.4	2.6	2.8	3.0	3.2	3.4	3.6	3.8	4.0
Psi	17	20	23	26	29	32	35	38	41	44	46	49	52	55	58
10 km/h Cyc			3450	3740	4030	4320	4610	4790	4970	5150	5330	5570	5810	6000	6190
25 km/h Cyc	2810	3115	3420	3560	3695	3835	3970	4160	4350	4540	4730	4880	5030		
30 km/h Cyc	2620	2905	3190	3320	3450	3580	3710	3890	4065	4245	4420	4560	4700		
25 km/h	2550	2830	3110	3235	3360	3485	3610	3785	3955	4130	4300	4440	4580		
30 km/h	2460	2730	3000	3120	3240	3360	3480	3650	3815	3985	4150	4280	4410		
50 km/h	2300	2550	2800	2915	3025	3140	3250	3405	3565	3720	3875	4000	4125		

Ø inches	Description	CAI	S mm	OD mm	LR mm	RC mm	Recommended Rim		Acceptable Rim		Tube (Code)	75% internal volume (litres)	Tread depth (mm)		
50	320/90 R50 150A8/150B TL	130813	314	1847	862	5539	W10		DW10A W10A	816	226	39			
Bar	1.2	1.4	1.6	1.8	2.0	2.2	2.4	2.6	2.8	3.0	3.2	3.4	3.6	3.8	4.0
Psi	17	20	23	26	29	32	35	38	41	44	46	49	52	55	58
10 km/h Cyc			2780	3025	3265	3510	3750	3900	4050	4200	4350	4540	4730	4880	5030
25 km/h Cyc	2260	2495	2730	2855	2980	3105	3230	3385	3535	3690	3840	3965	4090		
30 km/h Cyc	2110	2330	2550	2670	2785	2905	3020	3165	3305	3450	3590	3705	3820		
25 km/h	2050	2270	2490	2605	2715	2830	2940	3080	3220	3360	3500	3610	3720		
30 km/h	1980	2190	2400	2510	2620	2730	2840	2975	3105	3240	3370	3475	3580		
50 km/h	1850	2045	2240	2345	2445	2550	2650	2775	2900	3025	3150	3250	3350		

Ø inches	Description	CAI	S mm	OD mm	LR mm	RC mm	Recommended Rim		Acceptable Rim		Tube (Code)	75% internal volume (litres)	Tread depth (mm)			
50	380/90 R50 151A8/151B TL	036849	393	1935	912	5813	DW13A		DW12A W12A W13A			329	47			
Bar	1.2	1.4	1.6	1.8	2.0	2.2	2.4	2.6	2.8	3.0	3.2	3.4	3.6	3.8	4.0	
Psi	17	20	23	26	29	32	35	38	41	44	46	49	52	55	58	
10 km/h Cyc			3540	3945	4350	4555	4765	4970								5175
25 km/h Cyc	2880	3210	3540	3710	3875	4045	4210									
30 km/h Cyc	2690	3000	3305	3465	3620	3780	3935									
25 km/h	2620	2920	3220	3375	3525	3680	3830									
30 km/h	2525	2815	3100	3250	3395	3545	3690									
50 km/h	2360	2630	2900	3040	3175	3315	3450									

* Refer to the notes at the end of the tables of this range

MICHELIN AGRIBIB ROW CROP

Tyre specifications and pressure table (bar & psi). Load per tyre in kg*

Ø inches	Description	CAI	S mm	OD mm	LR mm	RC mm	Recommended Rim		Acceptable Rim		Tube (Code)	75% internal volume (litres)	Tread depth (mm)	
54	320/90 R54 151A8/151B TL	272304	315	1950	915	5852	W10				816	240	39	
Bar	1.2 1.4 1.6 1.8 2.0 2.2 2.4 2.6 2.8 3.0 3.2 3.4 3.6 3.8 4.0													
Psi	17 20 23 26 29 32 35 38 41 44 46 49 52 55 58													
10 km/h Cyc		2930	3165	3395	3630	3860	4020	4180	4340	4500	4690	4880	5030	5180
25 km/h Cyc	2380 2630	2880	2990	3100	3210	3320	3485	3645	3810	3970	4090	4210		
30 km/h Cyc	2220 2455	2690	2795	2900	3005	3110	3260	3410	3560	3710	3820	3930		
25 km/h	2160 2390	2620	2720	2820	2920	3020	3170	3315	3465	3610	3720	3830		
30 km/h	2090 2310	2530	2630	2725	2825	2920	3060	3200	3340	3480	3585	3690		
50 km/h	1950 2155	2360	2450	2545	2635	2725	2855	2990	3120	3250	3350	3450		

*IMPORTANT:

The inflation pressure must always be appropriate for the load per tyre, the speed of travel and the work to be done. Our recommendations above were correct as of the time of publication of these tables (June 2018). Technical data is subject to change without prior notice.

- For use on side slopes: add 0.4 bar without exceeding the max. tyre pressure.
- For heavy road use, add 0.4 bar.
- Use 10, 25 or 30 km/h cyclic loading tables for field use only, travel with full load not to exceed 1,5 km/h.



MICHELIN CARGOXBIB HIGH FLOTATION

**THE LOW-PRESSURE
TRAILER TYRE WITH
LESS IMPACT ON THE SOIL**



The optimum performance **FROM ROAD TO FIELD**



SOIL PROTECTION

thanks to low pressure from 0,8 bar and +37% footprint⁽¹⁾



Tread design with outstanding **SELF-CLEANING ABILITY**



Excellent **ROAD HANDLING**



FLAT CROWN & LARGE FOOTPRINT

- Even distribution of contact pressure to minimise rutting and soil damage
- Central rib provides excellent resistance to wear and reduces rolling resistance

(1) Internal studies at Michelin's Technology Centre April 2012 / June 2013

SIZES

710/45 R22.5 165D TL
28 LR 26 175D TL
600/55 R26.5 165D TL
VF600/55 R26,5 170D IMP TL NEW
710/50 R26.5 170D TL
VF710/50 R26,5 176D IMP TL NEW

650/55 R26.5 169D TL
VF650/55 R26,5 174D IMP TL NEW
650/65 R30.5 176D TL
750/60 R30.5 181D TL
VF750/60 R30,5 187D IMP TL NEW
800/60 R32 185D IMP TL

MICHELIN CARGOXBIB HIGH FLOTATION

Tyre specifications and pressure table (bar & psi). Load per tyre in kg*

Ø inches	Description	CAI	S mm	OD mm	LR mm	RC mm	Recommended Rim		Acceptable Rim		Tube (Code)	75% internal volume (litres)	Tread depth (mm)
22.5	710/45 R22.5 165D TL	723051	723	1208	514	3545	AG24.00 (H2)		AG20.00 (H2)			317	16
Bar	0.8 0.9 1.0 1.2 1.5 1.8 2.1 2.4 2.7	1.2 1.5 1.8 2.1 2.4 2.7 3.0 3.2 3.4 3.6 3.8 4.0											
Psi	12 13 15 17 22 26 30 35 39	44 46 49 52 55 58											
10 km/h	2970 3430 3890	4325 4970 5620	6270 6920 7360	7800 8095 8390	8685 8975 9270								
25 km/h	2610 2930 3250	3650 4255 4855	5460 6060 6450	6840 7100 7360	7620 7880 8140								
40 km/h	2250 2525 2800	3145 3665 4185	4700 5220 5555	5890 6110 6335	6555 6780 7000								
50 km/h	2000 2245 2490	2795 3260 3720	4180 4640 4940	5235 5435 5635	5835 6030 6230								
65 km/h	1650 1855 2060	2315 2695 3075	3460 3840 4085	4330 4495 4660	4825 4985 5150								

Ø inches	Description	CAI	S mm	OD mm	LR mm	RC mm	Recommended Rim		Acceptable Rim		Tube (Code)	75% internal volume (litres)	Tread depth (mm)
26	28 LR 26 175D TL (710/65 R26)	224829	740	1581	705	4685	DW25B (A)		DW23B (A)			577	26
Bar	0.8 0.9 1.0 1.2 1.5 1.8 2.1 2.4 2.7	3.0 3.2 3.4 3.6 3.8 4.0											
Psi	12 13 15 17 22 26 30 35 39	44 46 49 52 55 58											
15 km/h	3750 3935 4120	4615 5360 5905	6460 7035 7605	7905 8140 8375	8710 8980 9245								
25 km/h	3320 3485 3645	4085 4740 5220	5710 6220 6725	6990 7200 7405	7705 7940 8175								
40 km/h	3065 3215 3365	3770 4380 4825	5280 5750 6215	6460 6655 6845	7120 7340 7555								
50 km/h	2940 3085 3230	3620 4200 4625	5060 5515 5960	6195 6380 6565	6825 7035 7245								
65 km/h	2800 2940 3075	3445 4000 4405	4820 5250 5675	5900 6075 6250	6500 6700 6900								

Ø inches	Description	CAI	S mm	OD mm	LR mm	RC mm	Recommended Rim		Acceptable Rim		Tube (Code)	75% internal volume (litres)	Tread depth (mm)
26.5	600/55 R26.5 165D TL	550621	626	1341	581	3954	AG20.00 (H2)				716	312	17
Bar	0.8 0.9 1.0 1.2 1.5 1.8 2.1 2.4 2.7	3.0 3.2 3.4 3.6 3.8 4.0											
Psi	12 13 15 17 22 26 30 35 39	44 46 49 52 55 58											
10 km/h	2970 3585 4200	4675 5380 6090	6800 7510 7840	8170 8390 8610	8830 9050 9270								
25 km/h	2610 3085 3560	3995 4640 5290	5940 6590 6880	7170 7365 7560	7755 7945 8140								
40 km/h	2250 2675 3100	3465 4020 4570	5120 5670 5920	6170 6335 6500	6670 6835 7000								
50 km/h	2000 2375 2750	3080 3570 4065	4555 5050 5270	5495 5640 5790	5935 6085 6230								
65 km/h	1650 1975 2300	2565 2970 3370	3770 4170 4355	4540 4660 4785	4905 5030 5150								

Ø inches	Description	CAI	S mm	OD mm	LR mm	RC mm	Recommended Rim		Acceptable Rim		Tube (Code)	75% internal volume (litres)	Tread depth (mm)
26.5	VF600/55 R26.5 170D IMP TL NEW	377726	626	1341	587	3959	AG20.00 (H2)					312	17
Bar	0.8 0.9 1.0 1.2 1.5 1.8 2.1 2.4 2.7	3.0 3.2 3.4 3.6 3.8 4.0											
Psi	12 13 15 17 22 26 30 35 39	44 46 49 52 55 58											
65 km/h	2300 2450 2600	2900 3450 3855	4280 4750 5275	5600 6000									

* Refer to the notes at the end of the tables of this range

MICHELIN CARGOXBIB HIGH FLOTATION

Tyre specifications and pressure table (bar & psi). Load per tyre in kg*

Ø inches	Description	CAI	S mm	OD mm	LR mm	RC mm	Recommended Rim		Acceptable Rim		Tube (Code)	75% internal volume (litres)	Tread depth (mm)		
26.5	710/50 R26.5 170D TL	892516	729	1380	594	4061	AG24.00 (H2)		AG20.00 (H2)			407	18		
Bar	0.8	0.9	1.0	1.2	1.5	1.8	2.1	2.4	2.7	3.0	3.2	3.4	3.6	3.8	4.0
Psi	12	13	15	17	22	26	30	35	39	44	46	49	52	55	58
10 km/h	3510	4205	4900	5450	6275	7100	7925	8750	9135	9520	9775	10030	10290	10545	10800
25 km/h	3080	3610	4140	4645	5400	6155	6915	7670	8010	8350	8575	8800	9030	9255	9480
40 km/h	2650	3130	3610	4040	4680	5325	5965	6610	6900	7190	7385	7580	7775	7965	8160
50 km/h	2360	2780	3200	3585	4155	4730	5305	5880	6140	6400	6570	6745	6915	7090	7260
65 km/h	1950	2315	2680	2990	3460	3925	4395	4860	5075	5290	5430	5575	5715	5860	6000

Ø inches	Description	CAI	S mm	OD mm	LR mm	RC mm	Recommended Rim		Acceptable Rim		Tube (Code)	75% internal volume (litres)	Tread depth (mm)		
26.5	VF710/50 R26.5 176D IMP TL NEW	343405	729	1380	600	3934	AG24.00 (H2)		AG20.00 (H2)			407	18		
Bar	0.8	0.9	1.0	1.2	1.5	1.8	2.1	2.4	2.7	3.0	3.2	3.4	3.6	3.8	4.0
Psi	12	13	15	17	22	26	30	35	39	44	46	49	52	55	58
65 km/h	2725	2930	3140	3550	4125	4575	5055	5600	6275	6700	7100				

Ø inches	Description	CAI	S mm	OD mm	LR mm	RC mm	Recommended Rim		Acceptable Rim		Tube (Code)	75% internal volume (litres)	Tread depth (mm)		
26.5	650/55 R26.5 169D TL	693431	657	1402	617	4158	AG20.00 (H2)				716	437	18		
Bar	0.8	0.9	1.0	1.2	1.5	1.8	2.1	2.4	2.7	3.0	3.2	3.4	3.6	3.8	4.0
Psi	12	13	15	17	22	26	30	35	39	44	46	49	52	55	58
10 km/h	3330	3985	4635	5220	6100	6875	7600	8325	8780	9235	9540	9765	9990	10215	10440
25 km/h	2925	3500	4070	4585	5355	6035	6675	7310	7710	8110	8375	8575	8770	8970	9165
40 km/h	2515	3010	3500	3945	4610	5195	5745	6290	6635	6980	7210	7380	7550	7720	7890
50 km/h	2240	2680	3115	3510	4100	4620	5110	5595	5905	6210	6415	6565	6720	6870	7020
65 km/h	1850	2215	2575	2900	3390	3820	4220	4625	4880	5130	5300	5425	5550	5675	5800

Ø inches	Description	CAI	S mm	OD mm	LR mm	RC mm	Recommended Rim		Acceptable Rim		Tube (Code)	75% internal volume (litres)	Tread depth (mm)		
26.5	VF650/55 R26.5 174D IMP TL NEW	776393	657	1402	607	4131	AG20.00		AG20.00 (H2)			437	18		
Bar	0.8	0.9	1.0	1.2	1.5	1.8	2.1	2.4	2.7	3.0	3.2	3.4	3.6	3.8	4.0
Psi	12	13	15	17	22	26	30	35	39	44	46	49	52	55	58
65 km/h	2575	2770	2965	3350	3875	4325	4830	5450	5975	6500	6700				

* Refer to the notes at the end of the tables of this range

MICHELIN CARGOXBIB HIGH FLOTATION

Tyre specifications and pressure table (bar & psi). Load per tyre in kg*

Ø inches	Description	CAI	S mm	OD mm	LR mm	RC mm	Recommended Rim		Acceptable Rim		Tube (Code)	75% internal volume (litres)	Tread depth (mm)		
30.5	650/65 R30.5 176D TL	139310	674	1622	699	4776	AG20.00 (H2)					600	21		
Bar	0.8	0.9	1.0	1.2	1.5	1.8	2.1	2.4	2.7	3.0	3.2	3.4	3.6	3.8	4.0
Psi	12	13	15	17	22	26	30	35	39	44	46	49	52	55	58
10 km/h	4140	4970	5800	6450	7430	8405	9385	10360	10815	11270	11570	11875	12175	12480	12780
25 km/h	3640	4270	4900	5495	6395	7290	8185	9080	9480	9885	10150	10420	10685	10955	11220
40 km/h	3130	3705	4280	4785	5545	6305	7060	7820	8165	8510	8740	8970	9200	9430	9660
50 km/h	2780	3285	3790	4245	4920	5600	6280	6960	7265	7570	7775	7980	8185	8385	8590
65 km/h	2300	2735	3170	3540	4090	4645	5195	5750	6005	6255	6425	6595	6765	6930	7100

Ø inches	Description	CAI	S mm	OD mm	LR mm	RC mm	Recommended Rim		Acceptable Rim		Tube (Code)	75% internal volume (litres)	Tread depth (mm)		
30.5	750/60 R30.5 181D TL	101332	786	1675	716	4936	AG24.00 (H2)					750	22		
Bar	0.8	0.9	1.0	1.2	1.5	1.8	2.1	2.4	2.7	3.0	3.2	3.4	3.6	3.8	4.0
Psi	12	13	15	17	22	26	30	35	39	44	46	49	52	55	58
10 km/h	4770	5750	6730	7490	8625	9765	10900	12040	12565	13095	13445	13795	14150	14500	14850
25 km/h	4185	4945	5700	6395	7430	8470	9510	10550	11015	11485	11795	12105	12420	12730	13040
40 km/h	3605	4290	4970	5560	6440	7325	8205	9090	9490	9890	10155	10420	10690	10955	11220
50 km/h	3205	3810	4410	4935	5720	6505	7295	8080	8435	8795	9030	9270	9505	9745	9980
65 km/h	2650	3165	3680	4110	4750	5395	6035	6680	6975	7270	7465	7660	7860	8055	8250

Ø inches	Description	CAI	S mm	OD mm	LR mm	RC mm	Recommended Rim		Acceptable Rim		Tube (Code)	75% internal volume (litres)	Tread depth (mm)		
30.5	VF750/60 R30.5 187D IMP TL NEW	139588	760	1680	724	4944	AG24.00 (H2)					650	21		
Bar	0.8	0.9	1.0	1.2	1.5	1.8	2.1	2.4	2.7	3.0	3.2	3.4	3.6	3.8	4.0
Psi	12	13	15	17	22	26	30	35	39	44	46	49	52	55	58
65 km/h	3750	4000	4250	4750	5600	6260	6965	7750	8500	9250	9750				

Ø inches	Description	CAI	S mm	OD mm	LR mm	RC mm	Recommended Rim		Acceptable Rim		Tube (Code)	75% internal volume (litres)	Tread depth (mm)		
32	800/60 R32 185D IMP TL	322432	818	1800	777	5300	DW27B (A)			DW25B (A)	831	900	24		
Bar	0.8	0.9	1.0	1.2	1.5	1.8	2.1	2.4	2.7	3.0	3.2	3.4	3.6	3.8	4.0
Psi	12	13	15	17	22	26	30	35	39	44	46	49	52	55	58
10 km/h	5400	6525	7650	8580	9975	11205	12355	13500	14345	15190	15750	15975	16200	16425	16650
25 km/h	4740	5730	6715	7530	8755	9835	10845	11850	12590	13330	13825	14025	14220	14420	14615
40 km/h	4080	4930	5780	6485	7540	8470	9335	10200	10840	11475	11900	12070	12240	12410	12580
50 km/h	3630	4390	5145	5770	6710	7535	8305	9075	9645	10210	10590	10740	10895	11045	11195
65 km/h	3000	3625	4250	4765	5540	6225	6865	7500	7970	8440	8750	8875	9000	9125	9250

***IMPORTANT:**

The inflation pressure must always be appropriate for the load per tyre, the speed of travel and the work to be done. Our recommendations above were correct as of the time of publication of these tables (June 2018). Technical data is subject to change without prior notice.

- For use on side slopes: add 0.4 bar.
- For heavy road use, add 0.4 bar.



MICHELIN CARGOXBIB HEAVY DUTY

**EXCELLENT VALUE
FOR TRANSPORTING
YOUR HARVESTS**



SELF-CLEANING ABILITY



STABILITY

- Excellent road handling



SERVICE LIFE

- Proven casing endurance



FLAT CROWN & LARGE FOOTPRINT

- Even distribution of contact pressure to minimise rutting and soil damage
- Tripod tread pattern provides great stability on side slopes and regular wear

SIZES

560/45 R22.5 152D TL

500/60 R22.5 155D TL

560/60 R22.5 161D TL

MICHELIN CARGOXBIB HEAVY DUTY

Tyre specifications and pressure table (bar & psi). Load per tyre in kg*

Ø inches	Description	CAI	S mm	OD mm	LR mm	RC mm	Recommended Rim		Acceptable Rim		Tube (Code)	75% internal volume (litres)	Tread depth (mm)		
22.5	560/45 R22.5 152D TL	743789	535	1080	474	3191	AG16.00 (H2)					182	16		
Bar	0.8	0.9	1.0	1.2	1.5	1.8	2.1	2.4	2.7	3.0	3.2	3.4	3.6	3.8	4.0
Psi	12	13	15	17	22	26	30	35	39	44	46	49	52	55	58
10 km/h	2070	2225	2375	2665	3095	3475	3845	4245	4650	5050	5320	5585	5855	6120	6390
25 km/h	1820	1955	2085	2340	2720	3050	3375	3725	4080	4435	4670	4905	5140	5375	5610
40 km/h	1565	1680	1795	2015	2340	2625	2900	3205	3510	3815	4020	4220	4425	4625	4830
50 km/h	1390	1495	1600	1795	2085	2340	2585	2855	3125	3400	3580	3760	3940	4120	4300
65 km/h	1150	1235	1320	1480	1720	1930	2135	2360	2580	2805	2955	3105	3250	3400	3550

Ø inches	Description	CAI	S mm	OD mm	LR mm	RC mm	Recommended Rim		Acceptable Rim		Tube (Code)	75% internal volume (litres)	Tread depth (mm)		
22.5	500/60 R22.5 155D TL	441880	505	1172	508	3454	AG16.00 (H2)		14.00 15.00 16.00 17.00			206	16		
Bar	0.8	0.9	1.0	1.2	1.5	1.8	2.1	2.4	2.7	3.0	3.2	3.4	3.6	3.8	4.0
Psi	12	13	15	17	22	26	30	35	39	44	46	49	52	55	58
10 km/h	2250	2705	3160	3515	4050	4585	5115	5650	5900	6150	6315	6480	6650	6815	6980
25 km/h	1975	2330	2680	3005	3495	3985	4470	4960	5180	5395	5540	5685	5830	5975	6120
40 km/h	1700	2015	2330	2605	3025	3440	3855	4270	4460	4645	4770	4895	5020	5145	5270
50 km/h	1510	1790	2070	2315	2690	3060	3430	3800	3965	4135	4245	4355	4470	4580	4690
65 km/h	1250	1490	1730	1930	2235	2535	2840	3140	3280	3420	3510	3605	3695	3790	3880

Ø inches	Description	CAI	S mm	OD mm	LR mm	RC mm	Recommended Rim		Acceptable Rim		Tube (Code)	75% internal volume (litres)	Tread depth (mm)		
22.5	560/60 R22.5 161D TL	102433	543	1242	532	3650	AG16.00 (H2)		16.00 17.00 AG20.00 (H2)			269	16		
Bar	0.8	0.9	1.0	1.2	1.5	1.8	2.1	2.4	2.7	3.0	3.2	3.4	3.6	3.8	4.0
Psi	12	13	15	17	22	26	30	35	39	44	46	49	52	55	58
10 km/h	2700	3240	3780	4205	4840	5475	6115	6750	7045	7345	7540	7740	7935	8135	8330
25 km/h	2370	2780	3190	3580	4160	4745	5325	5910	6175	6435	6610	6785	6960	7135	7310
40 km/h	2040	2415	2790	3120	3610	4105	4595	5090	5315	5540	5690	5840	5990	6140	6290
50 km/h	1810	2140	2470	2765	3205	3645	4090	4530	4730	4930	5065	5200	5335	5465	5600
65 km/h	1500	1785	2070	2310	2670	3030	3390	3750	3915	4080	4190	4300	4410	4520	4630

* Refer to the notes at the end of the tables of this range



MICHELIN CARGOXBIB

**ENHANCED ENDURANCE
FOR HEAVY LOADS
AT LOW PRESSURES**



ENDURANCE



PRODUCTIVITY

- Low ground compaction
- Puncture resistant
- Crop protection



PROFITABILITY

- Low ground pressure helps protect crops and increase yield



FLAT PROFILE & WIDE FOOTPRINT

- Supports wear life

SIZES

600/50 R22.5 159D TL

800/45 R26.5 174D TL

710/50 R30.5 173D TL

800/45 R30.5 176D TL

600/60 R30.5 169D TL

850/50 R30.5 182D TL

MICHELIN CARGOXBIB

Tyre specifications and pressure table (bar & psi). Load per tyre in kg*

Ø inches	Description	CAI	S mm	OD mm	LR mm	RC mm	Recommended Rim		Acceptable Rim	Tube (Code)	75% internal volume (litres)	Tread depth (mm)
22.5	600/50 R22.5 159D TL	048429	616	1181	510	3478	AG20.00 (H2)				298	17
Bar	1.0	1.3	1.5	1.9	2.2	2.5	2.8	3.1	3.4	3.7	4.0	
Psi	15	19	22	28	32	36	41	45	49	54	58	
10 km/h	3570	4170	4575	5375	5980	6475	6755	7035	7320	7600	7880	
25 km/h	3020	3570	3940	4670	5225	5675	5920	6170	6415	6665	6910	
40 km/h	2640	3105	3420	4040	4510	4890	5105	5315	5525	5740	5950	
50 km/h	2340	2760	3035	3595	4010	4355	4540	4730	4915	5105	5290	
65 km/h	1950	2290	2520	2970	3315	3595	3750	3910	4065	4225	4380	

Ø inches	Description	CAI	S mm	OD mm	LR mm	RC mm	Recommended Rim		Acceptable Rim	Tube (Code)	75% internal volume (litres)	Tread depth (mm)
26.5	800/45 R26.5 174D TL	248959	815	1395	595	4097	AG28.00 (H2)		AG24.00 (H2)		561	19
Bar	1.0	1.3	1.5	1.9	2.2	2.5	2.8	3.1	3.4	3.7	4.0	
Psi	15	19	22	28	32	36	41	45	49	54	58	
10 km/h	5070	5910	6475	7595	8440	9190	9765	10340	10915	11485	12060	
25 km/h	4230	5015	5535	6585	7365	8060	8565	9070	9580	10085	10590	
40 km/h	3640	4315	4765	5665	6340	6935	7370	7805	8240	8675	9110	
50 km/h	3240	3840	4240	5040	5640	6170	6560	6945	7335	7720	8110	
65 km/h	2680	3175	3505	4165	4660	5095	5420	5740	6060	6380	6700	

Ø inches	Description	CAI	S mm	OD mm	LR mm	RC mm	Recommended Rim		Acceptable Rim	Tube (Code)	75% internal volume (litres)	Tread depth (mm)
30.5	710/50 R30.5 173D TL	002786	728	1495	649	4408	AG24.00 (H2)				537	21
Bar	1.0	1.3	1.5	1.9	2.2	2.5	2.8	3.1	3.4	3.7	4.0	
Psi	15	19	22	28	32	36	41	45	49	54	58	
10 km/h	5310	6205	6800	7990	8885	9620	10035	10450	10870	11285	11700	
25 km/h	4490	5310	5855	6945	7765	8435	8800	9170	9535	9905	10270	
40 km/h	3910	4605	5070	6000	6695	7265	7580	7895	8210	8525	8840	
50 km/h	3470	4090	4505	5335	5955	6465	6745	7025	7310	7590	7870	
65 km/h	2900	3410	3745	4425	4930	5345	5580	5810	6040	6270	6500	

* Refer to the notes at the end of the tables of this range

MICHELIN CARGOXBIB

Tyre specifications and pressure table (bar & psi). Load per tyre in kg*

Ø inches	Description	CAI	S mm	OD mm	LR mm	RC mm	Recommended Rim	Acceptable Rim	Tube (Code)	75% internal volume (litres)	Tread depth (mm)
30.5	800/45 R30.5 176D TL	932951	820	1495	650	4408	AG28.00 (H2)			616	21
Bar	1.0	1.3	1.5	1.9	2.2	2.5	2.8	3.1	3.4	3.7	4.0
Psi	15	19	22	28	32	36	41	45	49	54	58
10 km/h	5370	6265	6860	8050	8945	9745	10350	10960	11565	12175	12780
25 km/h	4490	5320	5870	6980	7805	8540	9075	9610	10150	10685	11220
40 km/h	3860	4575	5055	6005	6725	7355	7815	8275	8740	9200	9660
50 km/h	3440	4075	4495	5345	5975	6535	6950	7360	7770	8180	8590
65 km/h	2840	3365	3715	4415	4940	5405	5745	6080	6420	6760	7100

Ø inches	Description	CAI	S mm	OD mm	LR mm	RC mm	Recommended Rim	Acceptable Rim	Tube (Code)	75% internal volume (litres)	Tread depth (mm)
30.5	600/60 R30.5 169D TL	236518	639	1496	654	4417	AG20.00 (H2)			469	21
Bar	1.0	1.3	1.5	1.9	2.2	2.5	2.8	3.1	3.4	3.7	4.0
Psi	15	19	22	28	32	36	41	45	49	54	58
10 km/h	4730	5530	6060	7130	7925	8585	8955	9325	9700	10070	10440
25 km/h	4000	4735	5220	6200	6930	7530	7855	8180	8510	8835	9160
40 km/h	3490	4110	4525	5355	5975	6485	6765	7045	7330	7610	7890
50 km/h	3100	3655	4020	4760	5310	5765	6015	6265	6520	6770	7020
65 km/h	2590	3040	3345	3945	4400	4770	4975	5180	5390	5595	5800

Ø inches	Description	CAI	S mm	OD mm	LR mm	RC mm	Recommended Rim	Acceptable Rim	Tube (Code)	75% internal volume (litres)	Tread depth (mm)
30.5	850/50 R30.5 182D TL	938016	861	1628	692	4778	AG28.00 (H2)			817	23
Bar	1.0	1.3	1.5	1.9	2.2	2.5	2.8	3.1	3.4	3.7	4.0
Psi	15	19	22	28	32	36	41	45	49	54	58
10 km/h	6430	7500	8210	9640	10705	11665	12390	13120	13845	14575	15300
25 km/h	5370	6365	7025	8355	9345	10225	10865	11505	12150	12790	13430
40 km/h	4620	5475	6050	7190	8050	8805	9355	9905	10460	11010	11560
50 km/h	4110	4875	5380	6400	7160	7835	8325	8815	9310	9800	10290
65 km/h	3400	4030	4450	5290	5920	6475	6880	7285	7690	8095	8500

***IMPORTANT:**

The inflation pressure must always be appropriate for the load per tyre, the speed of travel and the work to be done. Our recommendations above were correct as of the time of publication of these tables (June 2018). Technical data is subject to change without prior notice.

- For use on side slopes: add 0.4 bar.
- For heavy road use, add 0.4 bar.



MICHELIN XP 27

**ENHANCED ENDURANCE
FOR HEAVY LOADS
AT LOW PRESSURES**



PRODUCTIVITY



PROFITABILITY

SIZES

270/65 R16 134A8/122A8 TL

270/65 R18 136A8/124A8 TL

340/65 R18 149A8/137A8 TL

MICHELIN XP 27

Tyre specifications and pressure table (bar & psi). Load per tyre in kg*

Ø inches	Description	CAI	S mm	OD mm	LR mm	RC mm	Recommended Rim		Acceptable Rim		Tube (Code)	75% internal volume (litres)	Tread depth (mm)		
16	270/65 R16 134A8/122A8 TL	184332	265	755	333	2300	W8		W7 W9		827	45	9		
Bar	1.0	1.3	1.5	1.9	2.2	2.5	2.8	3.1	3.4	3.7	4.0	4.1	4.4	4.7	5.0
Psi	15	19	22	28	32	36	41	45	49	54	58	59	64	68	73
10 km/h	1060	1235	1350	1580	1755	1930	2105	2280	2450	2625	2800	2815	2870	2920	2970
25 km/h	895	1045	1145	1340	1490	1640	1785	1935	2085	2230	2380	2395	2440	2480	2525
30 km/h	840	980	1070	1255	1395	1535	1675	1815	1950	2090	2230	2245	2285	2330	2370
40 km/h	750	875	960	1125	1250	1375	1500	1625	1750	1875	2000	2010	2050	2085	2120
50 km/h	690	805	880	1035	1150	1265	1380	1495	1610	1725	1840	1850	1885	1915	1950

Ø inches	Description	CAI	S mm	OD mm	LR mm	RC mm	Recommended Rim		Acceptable Rim		Tube (Code)	75% internal volume (litres)	Tread depth (mm)		
18	270/65 R18 136A8/124A8 TL	133069	265	810	361	2472	W8		9 W9		438	51	9		
Bar	1.0	1.3	1.5	1.9	2.2	2.5	2.8	3.1	3.4	3.7	4.0	4.1	4.4	4.7	5.0
Psi	15	19	22	28	32	36	41	45	49	54	58	59	64	68	73
10 km/h	1120	1305	1425	1670	1855	2040	2225	2410	2590	2775	2960	2980	3030	3085	3140
25 km/h	950	1105	1210	1420	1575	1730	1885	2040	2200	2355	2510	2525	2570	2620	2665
30 km/h	890	1035	1135	1330	1480	1625	1770	1920	2065	2215	2360	2375	2420	2465	2510
40 km/h	800	930	1020	1195	1325	1455	1585	1715	1850	1980	2110	2125	2160	2200	2240
50 km/h	730	850	930	1095	1215	1335	1455	1575	1700	1820	1940	1950	1990	2025	2060

Ø inches	Description	CAI	S mm	OD mm	LR mm	RC mm	Recommended Rim		Acceptable Rim		Tube (Code)	75% internal volume (litres)	Tread depth (mm)		
18	340/65 R18 149A8/137A8 TL	415969	343	891	393	2720	11		9 W9		828	80	8		
Bar	1.0	1.3	1.5	1.9	2.2	2.5	2.8	3.1	3.4	3.7	4.0	4.1	4.4	4.7	5.0
Psi	15	19	22	28	32	36	41	45	49	54	58	59	64	68	73
10 km/h	1620	1885	2065	2420	2685	2950	3215	3480	3750	4015	4280	4305	4390	4470	4550
25 km/h	1380	1605	1755	2060	2285	2510	2735	2960	3190	3415	3640	3665	3730	3800	3870
30 km/h	1290	1505	1645	1930	2145	2360	2575	2790	3000	3215	3430	3450	3515	3575	3640
40 km/h	1160	1350	1475	1730	1920	2110	2300	2490	2680	2870	3060	3080	3135	3195	3250
50 km/h	1160	1350	1475	1730	1920	2110	2300	2490	2680	2870	3060	3080	3135	3195	3250

***IMPORTANT:**

The inflation pressure must always be appropriate for the load per tyre, the speed of travel and the work to be done. Our recommendations above were correct as of the time of publication of these tables (June 2018). Technical data is subject to change without prior notice.

- For use on side slopes: add 0.4 bar.
- For heavy road use, add 0.4 bar.

XP27: the 1st load index refers to use on a free wheel (use on hauled equipment), the 2nd refers to use on a drive wheel.

The load/pressure/speed tables correspond to use on a free wheel. For a drive wheel, a 30 % load reduction applies per pressure point.



MICHELIN XS

**THE ALL-TERRAIN, ALL
POSITION RADIAL TYRE FOR
CONSTRUCTION, INDUSTRY
AND PUBLIC WORKS**



ENDURANCE

- Casing made of steel for increased resistance to impacts with high load capacity
- Damage resistant tread pattern using Earthmover technology



MOBILITY

- Wide and flat tread for maximum flotation
- Made for long distance transport up to 80 km/h

SAFETY

- Flexible casing and tread pattern for being driven at low pressures



100% STEEL CONSTRUCTION

- Great stability
- Excellent puncture resistance and even pressure distribution across the contact patch.

SIZES

525/65 R 20.5 TL 173F MI

24 R 20.5 TL 176F MI

MICHELIN XS

Tyre specifications and pressure table (bar & psi). Load per tyre in kg*

Ø inches	Description	CAI	S mm	OD mm	LR mm	RC mm	Recommended Rim		Acceptable Rim		Tube (Code)	75% internal volume (litres)	Tread depth (mm)
20.5	525/65 R 20.5 TL 173F MI	109421	521	1200	549	3640	16				19.5/20.5 UD	253	17
Bar	1.5 1.8 2.0 2.2 2.4 2.6 2.8 3.0 3.2 3.4 3.6 3.8 4.0												
Psi	22 26 29 32 35 38 41 44 46 49 52 55 58												
30 km/h	2430 2860 3145 3430 3715 4050 4435 4815 4970 5130 5285 5445 5600												
40 km/h	2370 2770 3035 3300 3565 3875 4230 4580 4750 4920 5090 5260 5430												
50 km/h	2315 2680 2925 3165 3410 3695 4020 4350 4530 4715 4895 5080 5260												
65 km/h		3000	3195	3390	3585	3780	3970	4165	4360	4555	4750		
80 km/h			2325	2470	2620	2765	2915	3060	3205	3355	3500		

Ø inches	Description	CAI	S mm	OD mm	LR mm	RC mm	Recommended Rim		Acceptable Rim		Tube (Code)	75% internal volume (litres)	Tread depth (mm)
20.5	24 R 20.5 TL 176F MI	109174	602	1374	584	4148	18				20.5 WAMD	404	17
Bar	1.5 1.8 2.0 2.2 2.4 2.6 2.8 3.0 3.2 3.4 3.6 3.8 4.0												
Psi	22 26 29 32 35 38 41 44 46 49 52 55 58												
30 km/h	3800 4400 4800 5200 5600 6100 6705 7310 7550 7785 8025 8260 8500												
40 km/h	3650 4230 4615 5000 5385 5860 6415 6970 7215 7460 7705 7950 8195												
50 km/h	3505 4060 4435 4805 5175 5615 6120 6625 6880 7130 7385 7635 7890												
65 km/h		4350	4645	4940	5235	5530	5820	6115	6410	6705	7000		
80 km/h			3325	3535	3745	3955	4165	4370	4580	4790	5000		

***IMPORTANT:**

The inflation pressure must always be appropriate for the load per tyre, the speed of travel and the work to be done. Our recommendations above were correct as of the time of publication of these tables (June 2018). Technical data is subject to change without prior notice.

- For use on side slopes: add 0.4 bar.
- For heavy road use, add 0.4 bar.

MICHELIN COMPACT LINE

TYRES TECHNICAL DATA BOOK | 2019



AGRICULTURAL.MICHELIN.CO.UK

MICHELIN

SUMMARY

READING THE TECHNICAL DATA	134
RANGES BY USES	135
EQUIVALENT SIZES	136
COMPACT LINE	137
MICHELIN XMCL	137
MICHELIN XM 27	143
MICHELIN BIBLOAD HARD SURFACE	145
MICHELIN CROSSGRIP	150
MICHELIN XF	154
MICHELIN XM 47	156
MICHELIN BIBSTEEL ALL TERRAIN	159
MICHELIN BIBSTEEL HARD SURFACE	162
MICHELIN X TWEEL	164
MICHELIN POWER CL	165
MICHELIN POWER DIGGER	171

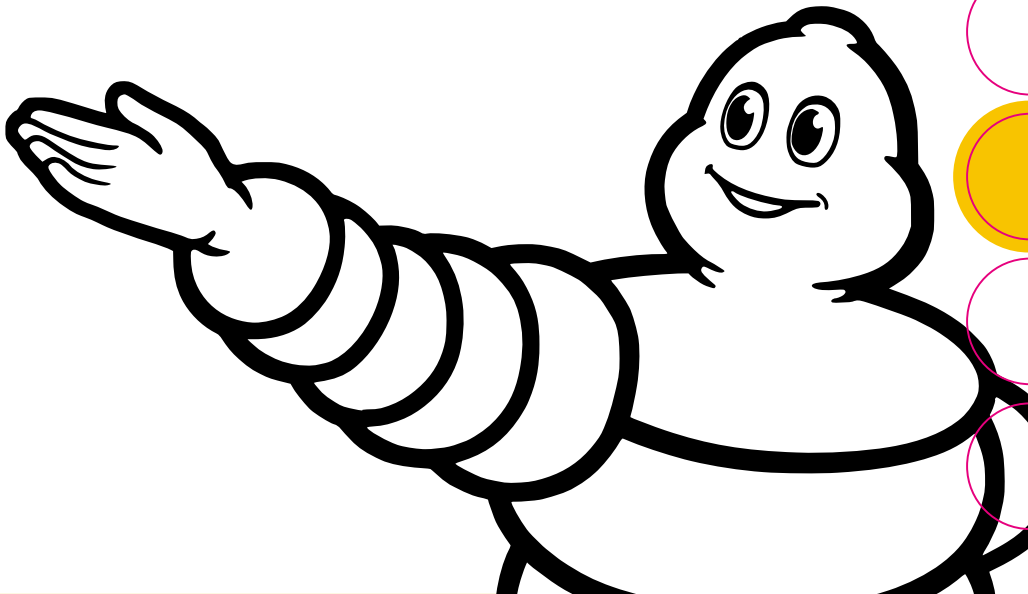

READING THE TECHNICAL DATA

Ø inches

Rim diameter in inches

Local country & International Product Code

(SW) Section Width in millimeters

(OD) Overall diameter in millimeters

(LR) Loaded Radius in millimeters

(RC) Rolling Circumference in millimeters

Ø inches	Description	CAI	S mm	D mm	R mm	Cdc mm	Recommended Rim	Acceptable Rim	Tube (Code)	75% internal volume (litres)	Tread depth (mm)
24	500/70 R24 164A8/164B IND TL <i>19.5 LR24 (Equiv 20PR)</i>	296638	536	1460	641	4316	W18L	W16L (NRO)	754	332	48

(IND) Industrial

(TL) Tubeless

Equivalent standard size

Pressure scale in bar and psi

Bar	0.4	0.6	0.8	0.9	1	1.1	1.2	1.3	1.4	1.5	1.6	1.7	1.8	1.9	2
Psi	6	9	12	13	15	16	17	19	20	22	23	25	26	28	29
65 km/h		2180	2500	2690	2875	3065	3250	3405	3565	3720	3875	3970	4065	4155	4250
70 km/h		2000	2295	2470	2640	2815	2985	3130	3270	3415	3555	3640	3730	3815	3900
65 km/h Dual		1920	2180	2310	2440	2570	2700	2830	2960	3090	3220	3350	3480	3610	3740





Maximum speed in km/h

Load per tyre in kg



Important notes for tyre use appear at the end of technical data pages for each range.

RANGES BY USES

MACHINES / TYRES	TECHNOLOGY									
	RADIAL								BIAS	
	XMCL	BIBLOAD HS	CROSSGRIP	BIBSTEEL HS	BIBSTEELAT	TWHEEL HS	TWHEEL HS	XF	POWER DIGGER	POWER CL
 Backhoe loaders	X	X	X							X
 Compact wheeled loaders	X	X	X							X
 Telehandlers	X	X	X	X	X			X		X
 Wheeled excavators								X	X	
 Skid steers				X	X	X	X			

EQUIVALENT SIZES

EQUIVALENT SIZES				MICHELIN COMPACT LINE											
Rims	Pouces	Metric 1	Metric 2	XMCL	BIBLOAD HS	CROSSGRIP	XM47	POWER CL	BIBSTEEL HS	BIBSTEEL AT	TWHEEL HS	TWHEEL HS	XF	POWER DIGGER	XM27
15	27x8.5 R 15	210/70 R 15	215/70 R 15							X					
16	7.5 R 16	250/80 R 16				X									
	11 LR 16														X
16,5	10 R 16.5	260/70 R 16.5	265/70 R 16.5						X	X	X	X			
	12 R 16.5	300/70 R 16.5	305/70 R 16.5						X	X	X	X			
17,5	14 R 17.5	360/70 R 17.5								X					
18	10.5/80 R 18	280/80 R 18		X				X							
	12.5/80 R 18	340/80 R 18	335/80 R 18	X	X			X							
		400/70 R 18	405/70 R 18	X	X										
19,5	18 R 19.5	445/70 R 19.5											X		
20	10.5/80 R 20	280/80 R 20	335/80 R 20	X				X							
	12.5/80 R 20	340/80 R 20		X	X			X							
	14.5 R 20	380/75 R 20	375/75 R 20	X											
	16.0/70 R 20	400/70 R 20	405/70 R 20	X	X		X	X							
	16.5/75 R 20	425/75 R 20		X			X								
	10.00 R 20													X	
22,5	18 R 22.5	445/70 R 22.5											X		
24	16.0/70 R 24	400/70 R 24		X				X							
	16.9 R 24	440/80 R 24		X	X	X		X							
	17.5 LR 24	460/70 R 24	445/70 R 24	X	X		X	X							
	19.5 LR 24	500/70 R 24	495/70 R 24	X	X		X	X							
	21 LR 24	540/70 R 24		X	X										
	15.5/80 R 24	400/80 R 24				X		X							
26	18.4 R 26	480/80 R 26		X	X			X							
28	16.9 R 28	440/80 R 28		X	X	X		X							
30	16.9 R 30	420/80 R 30						X							



MICHELIN XMCL

**EXCEPTIONALLY RESISTANT
TO CUTS & EXCELLENT
TRACTION EVEN IN WET
& DIFFICULT CONDITIONS**



RADIAL TYRE

- Up to 46% more service life vs MICHELIN Bias tyre



TRACTION

- Effectiveness on soft ground



PRODUCTIVITY

- Reinforced sidewall & steel braced tread for puncture resistance



COMFORT

- Smoother ride



STABILITY

- Operational stability



STEEL BRACED TREAD

- Great stability
- Excellent puncture resistance and even pressure distribution across the contact patch.



Backhoe Loaders



Compact Wheel Loaders



Telehandlers

SIZES

280/80 R18 132A8/132B IND TL

340/80 R18 143A8/143B IND TL

400/70 R18 147A8/147B IND TL

280/80 R20 133A8/133B IND TL

340/80 R20 144A8/144B IND TL

400/70 R20 149A8/149B IND TL

380/75 R20 148A8/148B IND TL

420/75 R20 154A8/154B IND TL

400/70 R24 152A8/152B IND TL

460/70 R24 159A8/159B IND TL

500/70 R24 164A8/164B IND TL

440/80 R24 161A8/161B IND TL

540/70 R24 168A8/168B IND TL

480/80 R26 167A8/167B IND TL

440/80 R28 156A8/156B IND TL

MICHELIN XMCL

Tyre specifications and pressure table (bar & psi). Load per tyre in kg*

Ø inch	Description	CAI	S mm	OD mm	LR mm	RC mm	Recommended Rim		Acceptable Rim		Tube (Code)	75% internal volume (litres)	Tread depth (mm)
18	280/80 R18 132A8/132B IND TL <i>10.5 R18 (Equip 10PR)</i>	779803	290	908	415	2708	W9		W10 W8		438	68	28
Bar	1.6 2.0 2.2	2.4	2.6	2.8	3.0	3.2	3.4	3.6	3.8	4.0	4.2	4.4	
Psi	23 29 32	35	38	41	44	46	49	52	55	58	61	64	
Stat	1800 2200 2400	2600	2800	3000	3200	3400	3600	3800	4000	4200	4400	4600	
10 km/h Cyc	1170 1430 1565	1695	1825	1955	2085	2220	2350	2480	2610	2740	2870	3000	
25 km/h	1060 1255 1350	1445	1540	1635	1735	1830	1930	2025	2125	2220			
30 km/h	1020 1210 1300	1395	1490	1585	1675	1770	1865	1955	2050	2140			
40 km/h	950 1125 1215	1300	1390	1475	1565	1650	1740	1825	1915	2000			
50 km/h	950 1125 1215	1300	1390	1475	1565	1650	1740	1825	1915	2000			

Ø inch	Description	CAI	S mm	OD mm	LR mm	RC mm	Recommended Rim		Acceptable Rim		Tube (Code)	75% internal volume (litres)	Tread depth (mm)
18	340/80 R18 143A8/143B IND TL <i>12.5 R18 (Equip 12PR)</i>	100054	351	996	448	2959	11		11SDC 12 12SDC W10W11		444 828	107	31
Bar	1.6 2.0 2.2	2.4	2.6	2.8	3.0	3.2	3.4	3.6	3.8	4.0	4.2	4.4	
Psi	23 29 32	35	38	41	44	46	49	52	55	58	61	64	
Stat	2450 2995 3270	3540	3815	4090	4360	4635	4905	5180	5455	5725	6000	6270	
10 km/h Cyc	1600 1955 2135	2310	2490	2670	2845	3025	3200	3380	3555	3735	3915	4090	
25 km/h	1450 1715 1845	1975	2105	2240	2370	2500	2630	2760	2890	3020			
30 km/h	1390 1645 1775	1900	2030	2155	2285	2410	2540	2665	2795	2920			
40 km/h	1320 1550 1665	1780	1895	2010	2125	2240	2360	2485	2605	2725			
50 km/h	1320 1550 1665	1780	1895	2010	2125	2240	2360	2485	2605	2725			

Ø inch	Description	CAI	S mm	OD mm	LR mm	RC mm	Recommended Rim		Acceptable Rim		Tube (Code)	75% internal volume (litres)	Tread depth (mm)
18	400/70 R18 147A8/147B IND TL <i>405/70 R18</i>	133035	404	1013	454	3008	13					129	31
Bar	1.6 2.0 2.2	2.4	2.6	2.8	3.0	3.2	3.4	3.6	3.8	4.0	4.2	4.4	
Psi	23 29 32	35	38	41	44	46	49	52	55	58	61	64	
Stat	2800 3400 3700	4000	4300	4600	4930	5265	5595	5925	6215	6500	6790	7075	
10 km/h Cyc	1825 2215 2415	2610	2805	3000	3215	3435	3650	3865	4050	4240	4430	4615	
25 km/h	1670 1945 2085	2220	2380	2540	2700	2860	3000	3140	3275	3415			
30 km/h	1605 1875 2005	2140	2295	2450	2600	2755	2890	3025	3155	3290			
40 km/h	1500 1750 1875	2000	2145	2290	2430	2575	2700	2825	2950	3075			
50 km/h	1500 1750 1875	2000	2145	2290	2430	2575	2700	2825	2950	3075			

* Refer to the notes at the end of the tables of this range

MICHELIN XMCL

Tyre specifications and pressure table (bar & psi). Load per tyre in kg*

Ø inch	Description	CAI	S mm	OD mm	LR mm	RC mm	Recommended Rim		Acceptable Rim		Tube (Code)	75% internal volume (litres)	Tread depth (mm)
20	280/80 R20 133A8/133B IND TL <i>10.5 R20 (Equiv 10PR)</i>	747442	292	958	439	2860	W9		W10 W8		542	73	31
Bar	1.6 2.0 2.2 2.4 2.6 2.8 3.0 3.2 3.4												
Psi	23 29 32 35 38 41 44 46 49												
Stat	1850 2260 2470 2675 2880 3085 3290 3500 3705												
10 km/h Cyc	1210 1480 1610 1745 1880 2015 2150 2280 2415												
25 km/h	1090 1290 1390 1490 1590 1690 1790 1890 1990												
30 km/h	1050 1245 1340 1435 1530 1625 1725 1820 1915												
40 km/h	975 1155 1245 1340 1430 1520 1610 1700 1790												
50 km/h	975 1155 1245 1340 1430 1520 1610 1700 1790												

Ø inch	Description	CAI	S mm	OD mm	LR mm	RC mm	Recommended Rim		Acceptable Rim		Tube (Code)	75% internal volume (litres)	Tread depth (mm)
20	340/80 R20 144A8/144B IND TL <i>12.5 R20 (Equiv 12PR)</i>	948730	353	1047	476	3119	11		11SDC 12 12SDC W10 W11		664 444	114	31
Bar	1.6 2.0 2.2 2.4 2.6 2.8 3.0 3.2 3.4												
Psi	23 29 32 35 38 41 44 46 49												
Stat	2520 3080 3360 3640 3920 4200 4480 4760 5040												
10 km/h Cyc	1640 2005 2190 2370 2555 2740 2920 3105 3285												
25 km/h	1490 1760 1895 2030 2165 2300 2435 2570 2705												
30 km/h	1430 1690 1820 1950 2080 2210 2340 2470 2605												
40 km/h	1360 1595 1715 1830 1950 2065 2185 2300 2425												
50 km/h	1360 1595 1715 1830 1950 2065 2185 2300 2425												

Ø inch	Description	CAI	S mm	OD mm	LR mm	RC mm	Recommended Rim		Acceptable Rim		Tube (Code)	75% internal volume (litres)	Tread depth (mm)
20	400/70 R20 149A8/149B IND TL <i>16.0/70 R20 (Equiv 16PR)</i>	474495	412	1069	481	3177	13		12 12SDC 13SDC 14		664	140	33
Bar	1.6 2.0 2.2 2.4 2.6 2.8 3.0 3.2 3.4												
Psi	23 29 32 35 38 41 44 46 49												
Stat	2930 3580 3905 4230 4555 4880 5205 5530 5855												
10 km/h Cyc	1910 2335 2545 2760 2970 3180 3395 3605 3820												
25 km/h	1730 2045 2200 2355 2510 2670 2825 2980 3140												
30 km/h	1660 1965 2115 2265 2415 2570 2720 2870 3025												
40 km/h	1550 1825 1965 2100 2240 2375 2515 2650 2800												
50 km/h	1550 1825 1965 2100 2240 2375 2515 2650 2800												

* Refer to the notes at the end of the tables of this range

MICHELIN XMCL

Tyre specifications and pressure table (bar & psi). Load per tyre in kg*

Ø inch	Description	CAI	S mm	OD mm	LR mm	RC mm	Recommended Rim		Acceptable Rim		Tube (Code)	75% internal volume (litres)	Tread depth (mm)
20	380/75 R20 148A8/148B IND TL 14.5 R20 (Equiv 12PR)	187752	384	1070	481	3180	W12		11 12	W11	664	136	33
Bar	1.6 2.0 2.2	2.4	2.6	2.8	3.0	3.2	3.4	3.6	3.8	4.0	4.2	4.4	
Psi	23 29 32	35	38	41	44	46	49	52	55	58	61	64	
Stat	2840 3470 3785	4100	4415	4730	5045	5360	5675	5990	6305	6620	6935	7250	
10 km/h Cyc	1850 2260 2465	2670	2875	3080	3285	3490	3695	3900	4110	4315	4525	4730	
25 km/h	1670 1975 2130	2280	2435	2585	2740	2890	3045	3195	3350	3500			
30 km/h	1610 1905 2050	2195	2340	2490	2635	2780	2930	3075	3225	3370			
40 km/h	1500 1770 1905	2040	2170	2305	2440	2575	2720	2865	3005	3150			
50 km/h	1500 1770 1905	2040	2170	2305	2440	2575	2720	2865	3005	3150			

Ø inch	Description	CAI	S mm	OD mm	LR mm	RC mm	Recommended Rim		Acceptable Rim		Tube (Code)	75% internal volume (litres)	Tread depth (mm)
20	420/75 R20 154A8/154B IND TL 16.5/75 R20 (Equiv 18PR)	967201	428	1138	509	3378	13		12 12SDC 13SDC 14	664	172	33	
Bar	1.6 2.0 2.2	2.4	2.6	2.8	3.0	3.2	3.4	3.6	3.8	4.0	4.2	4.4	
Psi	23 29 32	35	38	41	44	46	49	52	55	58	61	64	
Stat	3380 4130 4505	4880	5255	5630	6005	6380	6755	7130	7505	7880	8255	8630	
10 km/h Cyc	2200 2690 2935	3180	3425	3670	3915	4160	4405	4650	4895	5140	5385	5630	
25 km/h	1990 2355 2535	2715	2895	3080	3260	3440	3620	3800	3980	4160			
30 km/h	1920 2270 2440	2615	2790	2965	3135	3310	3485	3660	3835	4010			
40 km/h	1800 2120 2280	2440	2595	2755	2915	3075	3245	3415	3580	3750			
50 km/h	1800 2120 2280	2440	2595	2755	2915	3075	3245	3415	3580	3750			

Ø inch	Description	CAI	S mm	OD mm	LR mm	RC mm	Recommended Rim		Acceptable Rim		Tube (Code)	75% internal volume (litres)	Tread depth (mm)
24	400/70 R24 152A8/152B IND TL 16.0/70 R24 (Equiv 16PR)	178690	401	1170	531	3485	DW13L		13 13SDC DW12 DW13 DW14L	703	157	33	
Bar	1.6 2.0 2.2	2.4	2.6	2.8	3.0	3.2	3.4	3.6	3.8	4.0	4.2	4.4	
Psi	23 29 32	35	38	41	44	46	49	52	55	58	61	64	
Stat	3130 3840 4190	4545	4900	5255	5610	5960	6315	6670	7045	7420	7790	8165	
10 km/h Cyc	2040 2500 2735	2965	3195	3425	3655	3890	4120	4350	4595	4840	5080	5325	
25 km/h	1830 2180 2350	2525	2700	2875	3045	3220	3400	3580	3760	3940			
30 km/h	1765 2100 2270	2435	2605	2770	2940	3105	3280	3455	3625	3800			
40 km/h	1650 1965 2120	2275	2430	2590	2745	2900	3065	3225	3390	3550			
50 km/h	1650 1965 2120	2275	2430	2590	2745	2900	3065	3225	3390	3550			

* Refer to the notes at the end of the tables of this range

MICHELIN XMCL

Tyre specifications and pressure table (bar & psi). Load per tyre in kg*

Ø inch	Description	CAI	S mm	OD mm	LR mm	RC mm	Recommended Rim		Acceptable Rim	Tube (Code)	75% internal volume (litres)	Tread depth (mm)
24	460/70 R24 159A8/159B IND TL <i>17.5 LR24 (Equiv 18PR)</i>	244268	467	1248	562	3709	DW15L		14 16 DW14L DW16L TW14L	710	218	36
Bar	1.6 2.0 2.2	2.4	2.6	2.8	3.0	3.2	3.4	3.6	3.8	4.0	4.2	4.4
Psi	23 29 32	35	38	41	44	46	49	52	55	58	61	64
Stat	3940 4815 5250	5690	6125	6560	7000	7435	7875	8310	8750	9185	9625	10060
10 km/h Cyc	2570 3140 3425	3710	3995	4280	4565	4850	5135	5420	5705	5990	6275	6560
25 km/h	2320 2745 2955	3165	3375	3585	3800	4010	4225	4435	4650	4860		
30 km/h	2240 2650 2850	3055	3260	3460	3665	3870	4075	4275	4480	4680		
40 km/h	2120 2505 2695	2885	3075	3270	3460	3650	3830	4015	4195	4375		
50 km/h	2120 2505 2695	2885	3075	3270	3460	3650	3830	4015	4195	4375		

Ø inch	Description	CAI	S mm	OD mm	LR mm	RC mm	Recommended Rim		Acceptable Rim	Tube (Code)	75% internal volume (litres)	Tread depth (mm)
24	500/70 R24 164A8/164B IND TL <i>19.5 LR24 (Equiv 20PR)</i>	542794	511	1302	583	3866	DW16L		16 DW15L	710	266	36
Bar	1.6 2.0 2.2	2.4	2.6	2.8	3.0	3.2	3.4	3.6	3.8	4.0	4.2	4.4
Psi	23 29 32	35	38	41	44	46	49	52	55	58	61	64
Stat	4500 5500 6000	6500	7000	7500	8000	8500	9000	9500	10000	10500	11000	11500
10 km/h Cyc	2930 3585 3910	4240	4565	4890	5220	5545	5875	6200	6525	6850	7175	7500
25 km/h	2650 3135 3375	3615	3855	4100	4340	4580	4825	5065	5310	5550		
30 km/h	2560 3025 3260	3490	3725	3955	4190	4420	4655	4885	5120	5350		
40 km/h	2360 2800 3020	3245	3465	3685	3905	4125	4345	4565	4780	5000		
50 km/h	2360 2800 3020	3245	3465	3685	3905	4125	4345	4565	4780	5000		

Ø inch	Description	CAI	S mm	OD mm	LR mm	RC mm	Recommended Rim		Acceptable Rim	Tube (Code)	75% internal volume (litres)	Tread depth (mm)
24	440/80 R24 161A8/161B IND TL <i>16.9 R24 (Equiv 18PR)</i>	954749	441	1314	592	3907	DW14L		14 DW15L TW14L	710	236	36
Bar	1.6 2.0 2.2	2.4	2.6	2.8	3.0	3.2	3.4	3.6	3.8	4.0	4.2	4.4
Psi	23 29 32	35	38	41	44	46	49	52	55	58	61	64
Stat	4160 5085 5550	6010	6475	6940	7400	7865	8325	8790	9255	9715	10180	10640
10 km/h Cyc	2710 3315 3615	3920	4220	4520	4825	5125	5430	5730	6030	6335	6640	6940
25 km/h	2460 2905 3130	3350	3575	3795	4020	4240	4465	4685	4910	5130		
30 km/h	2370 2800 3015	3230	3445	3660	3875	4090	4305	4520	4735	4950		
40 km/h	2240 2650 2855	3060	3260	3465	3670	3875	4065	4250	4440	4625		
50 km/h	2240 2650 2855	3060	3260	3465	3670	3875	4065	4250	4440	4625		

* Refer to the notes at the end of the tables of this range

MICHELIN XMCL

Tyre specifications and pressure table (bar & psi). Load per tyre in kg*

Ø inch	Description	CAI	S mm	OD mm	LR mm	RC mm	Recommended Rim		Acceptable Rim	Tube (Code)	75% internal volume (litres)	Tread depth (mm)
24	540/70 R24 168A8/168B IND TL 2.1 LR24 (Equiv 20PR)	959128	562	1356	608	4026	DW18L		DW16L	710	317	36
Bar	1.6 2.0 2.2	2.4	2.6	2.8	3.0	3.2	3.4	3.6	3.8	4.0	4.2	4.4
Psi	23 29 32	35	38	41	44	46	49	52	55	58	61	64
Stat	5015 5910 6360	6805	7255	7700	8150	8595	9045	9490	10335	11185	12035	12880
10 km/h Cyc	3270 3855 4145	4440	4730	5020	5315	5605	5900	6190	6740	7295	7850	8400
25 km/h	2940 3490 3765	4040	4310	4585	4860	5135	5405	5680	5950	6220		
30 km/h	2840 3370 3630	3895	4160	4425	4685	4950	5215	5475	5740	6000		
40 km/h	2650 3145 3390	3640	3885	4130	4380	4625	4870	5115	5355	5600		
50 km/h	2650 3145 3390	3640	3885	4130	4380	4625	4870	5115	5355	5600		

Ø inch	Description	CAI	S mm	OD mm	LR mm	RC mm	Recommended Rim		Acceptable Rim	Tube (Code)	75% internal volume (litres)	Tread depth (mm)
26	480/80 R26 167A8/167B IND TL 18.4 R26 (Equiv 20PR)	425979	495	1422	636	4218	DW15L		DW16L	716	302	36
Bar	1.6 2.0 2.2	2.4	2.6	2.8	3.0	3.2	3.4	3.6	3.8	4.0	4.2	4.4
Psi	23 29 32	35	38	41	44	46	49	52	55	58	61	64
Stat	4900 5990 6535	7080	7625	8170	8715	9260	9805	10350	10895	11445	11990	12535
10 km/h Cyc	3200 3910 4265	4620	4975	5330	5685	6040	6395	6750	7460	8175		
25 km/h	2890 3420 3680	3945	4210	4475	4735	5000	5265	5525	5790	6050		
30 km/h	2790 3300 3550	3805	4060	4315	4565	4820	5075	5330	5580	5835		
40 km/h	2575 3055 3295	3540	3780	4020	4260	4500	4740	4975	5215	5450		
50 km/h	2575 3055 3295	3540	3780	4020	4260	4500	4740	4975	5215	5450		

Ø inch	Description	CAI	S mm	OD mm	LR mm	RC mm	Recommended Rim		Acceptable Rim	Tube (Code)	75% internal volume (litres)	Tread depth (mm)
28	440/80 R28 156A8/156B IND TL 16.9 R28 (Equiv 18PR)	316223	459	1410	641	4200	DW14L		DW15L	822	260	36
Bar	1.6 2.0 2.2	2.4	2.6	2.8	3.0	3.2	3.4	3.6	3.8	4.0	4.2	4.4
Psi	23 29 32	35	38	41	44	46	49	52	55	58	61	64
Stat	4360 5330 5810	6295	6780	7265	7750	8230	8715	9200				
10 km/h Cyc	2840 3470 3790	4105	4420	4735	5050	5370	5685	6000				
25 km/h	2570 3040 3270	3505	3740	3970	4205	4440						
30 km/h	2480 2930 3155	3380	3605	3830	4055	4280						
40 km/h	2300 2725 2940	3150	3365	3575	3790	4000						
50 km/h	2300 2725 2940	3150	3365	3575	3790	4000						

***IMPORTANT:**

The inflation pressure must always be appropriate for the load per tyre, the speed of travel and the work to be done. Our recommendations above are provided subject to changes made after the date of publication of these tables (June 2018). Technical data is subject to change without prior notice.

- For use on side slopes: add 0.4 bar.
- For heavy road use, add 0.4 bar.
- Stat: static load.
- 10 km/h Cyc: max. speed 10 km/h with cyclic load.



MICHELIN XM 27

**EXCEPTIONALLY RESISTANT
TO CUTS & EXCELLENT
TRACTION EVEN IN WET
& DIFFICULT CONDITIONS**



RADIAL TYRE

- Up to 46% more service life vs MICHELIN Bias tyre



TRACTION

- Effectiveness on soft ground



PRODUCTIVITY

- Reinforced sidewall & steel braced tread for puncture resistance



EXCELLENT STABILITY



Backhoe loaders



Compact Wheel
Loaders

SIZES

11 LR16 122A8 IND TL

MICHELIN XM 27

Tyre specifications and pressure table (bar & psi). Load per tyre in kg*

Ø inch	Description	CAI	S mm	OD mm	LR mm	RC mm	Recommended Rim	Acceptable Rim	Tube (Code)	75% internal volume (litres)	Tread depth (mm)
16	11 LR16 122A8 IND TL	123207	291	850	375	2515	W8	W10L	184	60	23
Bar	0.6 0.8 1.0 1.2 1.4 1.6 1.7 1.8 1.9										
Psi	9 12 15 17 20 23 25 26 28										

***IMPORTANT:**

The inflation pressure must always be appropriate for the load per tyre, the speed of travel and the work to be done. Our recommendations above were correct as of the time of publication of these tables (June 2018). Technical data is subject to change without prior notice.

- For use on side slopes: add 0.4 bar.
- For heavy road use, add 0.4 bar.
- Stat: static load.
- 10 km/h Cyc: max. speed 10 km/h with cyclic load.



MICHELIN BIBLOAD HARD SURFACE

**LONG LIFE WITH EXCELLENT
RIDE QUALITY**



RADIAL TYRE



TRACTION

- +30% footprint vs XMCL



PRODUCTIVITY

- Steel braced tread for puncture resistance



COMFORT

- Excellent stability on slopes
- Same ride quality as XMCL



STEEL BRACED TREAD

- Great stability
- Excellent puncture resistance and even pressure distribution across the contact patch.



Backhoe loaders



Compact Wheel Loaders



Telehandlers

SIZES

340/80 R18 143A8/143B IND TL

400/70 R18 147A8/147B IND TL

340/80 R20 144A8/144B IND TL

400/70 R20 149A8/149B IND TL

460/70 R24 159A8/159B IND TL

440/80 R24 161A8/161B IND TL

500/70 R24 164A8/164B IND TL

540/70 R24 168A8/168B IND TL

480/80 R26 167A8/167B IND TL

440/80 R28 163A8/163B IND TL

MICHELIN BIBLOAD HARD SURFACE

Tyre specifications and pressure table (bar & psi). Load per tyre in kg*

Ø inch	Description	CAI	S mm	OD mm	LR mm	RC mm	Recommended Rim		Acceptable Rim		Tube (Code)	75% internal volume (litres)	Tread depth (mm)
18	340/80 R18 143A8/143B IND TL <i>12.5 R18 (Equiv 12PR)</i>	415829	342	990	448	2946	11	11SDC 12 12SDC W10 W11	828 444	107	28		
Bar	1.6 1.8 2.0	2.2 2.4 2.6 2.8 3.0 3.2	3.4 3.6 3.8 4.0 4.2 4.4										
Psi	23 26 29	32 35 38 41 44 46	49 52 55 58 61 64										
Stat	2450 2725 2995	3270 3540 3815 4090 4360 4635	4905 5180 5455 5725 6000 6270										
10 km/h Cyc	1600 1780 1955	2135 2310 2490 2670 2845 3025	3200 3380 3555 3735 3915 4090										
25 km/h	1450 1580 1715	1845 1975 2105 2240 2370 2500	2630 2760 2890 3020										
30 km/h	1390 1520 1645	1775 1900 2030 2155 2285 2410	2540 2665 2795 2920										
40 km/h	1320 1435 1550	1665 1780 1895 2010 2125 2240	2360 2485 2605 2725										
50 km/h	1320 1435 1550	1665 1780 1895 2010 2125 2240	2360 2485 2605 2725										

Ø inch	Description	CAI	S mm	OD mm	LR mm	RC mm	Recommended Rim		Acceptable Rim		Tube (Code)	75% internal volume (litres)	Tread depth (mm)
18	400/70 R18 147A8/147B IND TL <i>40S/70 R18</i>	239365	397	1006	448	2983	13	12 12SDC 13.00		129	29		
Bar	1.6 1.8 2.0	2.2 2.4 2.6 2.8 3.0 3.2	3.4 3.6 3.8 4.0 4.2 4.4										
Psi	23 26 29	32 35 38 41 44 46	49 52 55 58 61 64										
Stat	2800 3100 3400	3700 4000 4300 4600 4930 5265	5595 5925 6215 6500 6790 7075										
10 km/h Cyc	1825 2020 2215	2415 2610 2805 3000 3215 3435	3650 3865 4050 4240 4430 4615										
25 km/h	1670 1810 1945	2085 2220 2380 2540 2700 2860	3000 3140 3275 3415										
30 km/h	1605 1740 1875	2005 2140 2295 2450 2600 2755	2890 3025 3155 3290										
40 km/h	1500 1625 1750	1875 2000 2145 2290 2430 2575	2700 2825 2950 3075										
50 km/h	1500 1625 1750	1875 2000 2145 2290 2430 2575	2700 2825 2950 3075										

Ø inch	Description	CAI	S mm	OD mm	LR mm	RC mm	Recommended Rim		Acceptable Rim		Tube (Code)	75% internal volume (litres)	Tread depth (mm)
20	340/80 R20 144A8/144B IND TL <i>12.5 R20 (Equiv 12PR)</i>	991253	346	1041	473	3100	11	11SDC 12 12SDC W10 W11	664 444	114	28		
Bar	1.6 1.8 2.0	2.2 2.4 2.6 2.8 3.0 3.2	3.4 3.6 3.8 4.0 4.2 4.4										
Psi	23 26 29	32 35 38 41 44 46	49 52 55 58 61 64										
Stat	2520 2800 3080	3360 3640 3920 4200 4480 4760	5040 5320 5600 5880 6160 6440										
10 km/h Cyc	1640 1825 2005	2190 2370 2555 2740 2920 3105	3285 3470 3650 3835 4020 4200										
25 km/h	1490 1625 1760	1895 2030 2165 2300 2435 2570	2705 2840 2975 3110										
30 km/h	1430 1560 1690	1820 1950 2080 2210 2340 2470	2605 2735 2870 3000										
40 km/h	1360 1480 1595	1715 1830 1950 2065 2185 2300	2425 2550 2675 2800										
50 km/h	1360 1480 1595	1715 1830 1950 2065 2185 2300	2425 2550 2675 2800										

* Refer to the notes at the end of the tables of this range

MICHELIN BIBLOAD HARD SURFACE

Tyre specifications and pressure table (bar & psi). Load per tyre in kg*

Ø inch	Description	CAI	S mm	OD mm	LR mm	RC mm	Recommended Rim		Acceptable Rim	Tube (Code)	75% internal volume (litres)	Tread depth (mm)	
20	400/70 R20 149A8/149B IND TL 16.0/70 R20 (Equiv 16PR)	793611	403	1068	480	3174	13		12 12SDC 13SDC 14	664	140	29	
Bar	1.6 1.8 2.0	2.2	2.4	2.6	2.8	3.0	3.2	3.4	3.6	3.8	4.0	4.2	4.4
Psi	23 26 29	32	35	38	41	44	46	49	52	55	58	61	64
Stat	2930 3255 3580	3905	4230	4555	4880	5205	5530	5855	6180	6505	6830	7155	7480
10 km/h Cyc	1910 2120 2335	2545	2760	2970	3180	3395	3605	3820	4030	4245	4455	4670	4880
25 km/h	1730 1885 2045	2200	2355	2510	2670	2825	2980	3140	3295	3455	3610		
30 km/h	1660 1810 1965	2115	2265	2415	2570	2720	2870	3025	3175	3330	3480		
40 km/h	1550 1690 1825	1965	2100	2240	2375	2515	2650	2800	2950	3100	3250		
50 km/h	1550 1690 1825	1965	2100	2240	2375	2515	2650	2800	2950	3100	3250		

Ø inch	Description	CAI	S mm	OD mm	LR mm	RC mm	Recommended Rim		Acceptable Rim	Tube (Code)	75% internal volume (litres)	Tread depth (mm)	
24	460/70 R24 159A8/159B IND TL 17.5 LR24 (Equiv 18PR)	372690	467	1241	558	3688	DW15L		14 16 DW14L DW16L	710	218	33	
Bar	1.6 1.8 2.0	2.2	2.4	2.6	2.8	3.0	3.2	3.4	3.6	3.8	4.0	4.2	4.4
Psi	23 26 29	32	35	38	41	44	46	49	52	55	58	61	64
Stat	3940 4375 4815	5250	5690	6125	6560	7000	7435	7875	8310	8750	9185	9625	10060
10 km/h Cyc	2570 2855 3140	3425	3710	3995	4280	4565	4850	5135	5420	5705	5990	6275	6560
25 km/h	2320 2530 2745	2955	3165	3375	3585	3800	4010	4225	4435	4650	4860		
30 km/h	2240 2445 2650	2850	3055	3260	3460	3665	3870	4075	4275	4480	4680		
40 km/h	2120 2310 2505	2695	2885	3075	3270	3460	3650	3830	4015	4195	4375		
50 km/h	2120 2310 2505	2695	2885	3075	3270	3460	3650	3830	4015	4195	4375		

Ø inch	Description	CAI	S mm	OD mm	LR mm	RC mm	Recommended Rim		Acceptable Rim	Tube (Code)	75% internal volume (litres)	Tread depth (mm)	
24	440/80 R24 161A8/161B IND TL 16.9 R24 (Equiv 18PR)	814805	448	1299	584	3860	DW14L		14 DW15L	710	234	32	
Bar	1.6 1.8 2.0	2.2	2.4	2.6	2.8	3.0	3.2	3.4	3.6	3.8	4.0	4.2	4.4
Psi	23 26 29	32	35	38	41	44	46	49	52	55	58	61	64
Stat	4255 4720 5185	5650	6115	6585	7050	7515	7980	8445	8910	9345	9775	10210	10640
10 km/h Cyc	2775 3080 3380	3685	3990	4295	4595	4900	5205	5505	5810	6095	6375	6660	6940
25 km/h	2500 2720 2935	3155	3370	3590	3805	4025	4240	4475	4705	4940	5170		
30 km/h	2390 2630 2865	3105	3340	3580	3815	4055	4290	4485	4680	4875	5070		
40 km/h	2180 2375 2575	2770	2965	3160	3355	3555	3750	3970	4190	4405	4625		
50 km/h	2180 2375 2575	2770	2965	3160	3355	3555	3750	3970	4190	4405	4625		

* Refer to the notes at the end of the tables of this range

MICHELIN BIBLOAD HARD SURFACE

Tyre specifications and pressure table (bar & psi). Load per tyre in kg*

Ø inch	Description	CAI	S mm	OD mm	LR mm	RC mm	Recommended Rim	Acceptable Rim	Tube (Code)	75% internal volume (litres)	Tread depth (mm)		
24	500/70 R24 164A8/164B IND TL <i>19.5 LR24 (Equiv 20PR)</i>	346709	499	1299	594	3874	DW16L	16 DW15L	710	266	32		
Bar	1.6 1.8 2.0	2.2	2.4	2.6	2.8	3.0	3.2	3.4	3.6	3.8	4.0	4.2	4.4
Psi	23 26 29	32	35	38	41	44	46	49	52	55	58	61	64
Stat	4500 5000 5500	6000	6500	7000	7500	8000	8500	9000	9500	10000	10500	11000	11500
10 km/h Cyc	2930 3255 3585	3910	4240	4565	4890	5220	5545	5875	6200	6525	6850	7175	7500
25 km/h	2650 2890 3135	3375	3615	3855	4100	4340	4580	4825	5065	5310	5550		
30 km/h	2560 2795 3025	3260	3490	3725	3955	4190	4420	4655	4885	5120	5350		
40 km/h	2360 2580 2800	3020	3245	3465	3685	3905	4125	4345	4565	4780	5000		
50 km/h	2360 2580 2800	3020	3245	3465	3685	3905	4125	4345	4565	4780	5000		

Ø inch	Description	CAI	S mm	OD mm	LR mm	RC mm	Recommended Rim	Acceptable Rim	Tube (Code)	75% internal volume (litres)	Tread depth (mm)		
24	540/70 R24 168A8/168B IND TL <i>21 LR24 (Equiv 20PR)</i>	005412	567	1341	600	3981	DW18L	DW16L	710	317	33		
Bar	1.6 1.8 2.0	2.2	2.4	2.6	2.8	3.0	3.2	3.4	3.6	3.8	4.0	4.2	4.4
Psi	23 26 29	32	35	38	41	44	46	49	52	55	58	61	64
Stat	5015 5465 5910	6360	6805	7255	7700	8150	8595	9045	9490	10335	11185	12035	12880
10 km/h Cyc	3270 3560 3855	4145	4440	4730	5020	5315	5605	5900	6190	6740	7295	7850	8400
25 km/h	2940 3215 3490	3765	4040	4310	4585	4860	5135	5405	5680	5950	6220		
30 km/h	2840 3105 3370	3630	3895	4160	4425	4685	4950	5215	5475	5740	6000		
40 km/h	2650 2895 3145	3390	3640	3885	4130	4380	4625	4870	5115	5355	5600		
50 km/h	2650 2895 3145	3390	3640	3885	4130	4380	4625	4870	5115	5355	5600		

Ø inch	Description	CAI	S mm	OD mm	LR mm	RC mm	Recommended Rim	Acceptable Rim	Tube (Code)	75% internal volume (litres)	Tread depth (mm)		
26	480/80 R26 167A8/167B IND TL <i>18.4 R26 (Equiv 20PR)</i>	886709	509	1419	637	4215	DW15L	DW16L	716	304	33		
Bar	1.6 1.8 2.0	2.2	2.4	2.6	2.8	3.0	3.2	3.4	3.6	3.8	4.0	4.2	4.4
Psi	23 26 29	32	35	38	41	44	46	49	52	55	58	61	64
Stat	4900 5445 5990	6535	7080	7625	8170	8715	9260	9805	10350	10895	11445	11990	12535
10 km/h Cyc	3200 3555 3910	4265	4620	4975	5330	5685	6040	6395	6750	7460	8175		
25 km/h	2890 3155 3420	3680	3945	4210	4475	4735	5000	5265	5525	5790	6050		
30 km/h	2790 3045 3300	3550	3805	4060	4315	4565	4820	5075	5330	5580	5835		
40 km/h	2575 2815 3055	3295	3540	3780	4020	4260	4500	4740	4975	5215	5450		
50 km/h	2575 2815 3055	3295	3540	3780	4020	4260	4500	4740	4975	5215	5450		

* Refer to the notes at the end of the tables of this range

MICHELIN BIBLOAD HARD SURFACE

Tyre specifications and pressure table (bar & psi). Load per tyre in kg*

Ø inch	Description	CAI	S mm	OD mm	LR mm	RC mm	Recommended Rim		Acceptable Rim		Tube (Code)	75% internal volume (litres)	Tread depth (mm)
28	440/80 R28 163A8/163B IND TL <i>16,9 R28 (Equiv 18PR)</i>	195802	446	1407	637	4188	DW14L	DW15L	822	259	33		
Bar	1.6 1.8 2.0 2.2 2.4 2.6 2.8 3.0 3.2 3.4 3.6 3.8 4.0 4.2 4.4												
Psi	23 26 29 32 35 38 41 44 46 49 52 55 58 61 64												
Stat	4370 4930 5485 6045 6605 7165 7720 8280 8840 9395 9955 10515 11075 11630 12190												
10 km/h Cyc	2850 3275 3700 4125 4550 4975 5400 5825 6250 6675 7100 7525 7950												
25 km/h	2620 2855 3085 3320 3550 3785 4015 4250 4480 4715 4945 5180 5410												
30 km/h	2525 2750 2975 3200 3420 3645 3870 4095 4320 4545 4765 4990 5215												
40 km/h	2360 2570 2780 2990 3200 3410 3620 3825 4035 4245 4455 4665 4875												
50 km/h	2360 2570 2780 2990 3200 3410 3620 3825 4035 4245 4455 4665 4875												

***IMPORTANT:**

The inflation pressure must always be appropriate for the load per tyre, the speed of travel and the work to be done. Our recommendations above were correct as of the time of publication of these tables (June 2018). Technical data is subject to change without prior notice.

- For use on side slopes: add 0.4 bar.
- For heavy road use, add 0.4 bar.
- Stat: static load.
- 10 km/h Cyc: max. speed 10 km/h with cyclic load.



NEW

MICHELIN CROSSGRIP

**A MULTI-PURPOSE TYRE
FOR USE ON THE ROAD,
GRASS AND SNOW**



VERSATILITY

- A specific rubber compound designed for 4-season use
- Non-directional pattern



PRODUCTIVITY

- Greater load at 65 km/h⁽¹⁾
- Non-directional tread for excellent precision in forward and reverse gear



TRACTION

- Multiple biting edges with optimized tread pattern for good traction on snow (M+S)



STEEL BRACED TREAD

- Combined with exclusive rubber compounds protect against tread puncture and deliver superior overall performance.



Backhoe loaders



Compact Wheel Loaders



Tractor



Telehandlers

(1) For the 440/80 R28 163A8/158D IND TL size, the MICHELIN 158D tyre can carry 4,250 kg at 65 km/h while competitor 151D tyres carry 3,450 Kg at 65 km/h. Source: ETRTO standard.

SIZES

250/80 R16 124A8/120D IND TL
400/80 R24 156A8/151D IND TL
460/70 R24 159A8/154D IND TL NEW
440/80 R24 161A8/156D IND TL
400/80 R28 158A8/153D IND TL NEW
440/80 R28 163A8/158D IND TL

480/80 R38 166A8/161D IND TL **NEW**

MICHELIN CROSSGRIP

Tyre specifications and pressure table (bar & psi). Load per tyre in kg*

Ø inch	Description	CAI	S mm	OD mm	LR mm	RC mm	Recommended Rim		Acceptable Rim		Tube (Code)	75% internal volume (litres)	Tread depth (mm)		
16	250/80 R16 124A8/120D IND TL 7.5 R16	564847	259	804	364	2402	W8		W7 W9		184	48	17		
Bar	1.6	1.8	2.0	2.2	2.4	2.6	2.8	3.0	3.2	3.4	3.6	3.8	4.0	4.2	4.4
Psi	23	26	29	32	35	38	41	44	46	49	52	55	58	61	64
Stat	1450	1610	1765	1925	2085	2245	2400	2560	2720	2875	3035	3195	3360	3520	3680
10 km/h Cyc	945	1050	1150	1255	1360	1465	1565	1670	1775	1875	1980	2085	2190	2295	2400
25 km/h	850	915	980	1045	1110	1175	1240	1305	1370	1465	1560	1655	1750		
30 km/h	820	885	950	1015	1080	1145	1210	1275	1340	1435	1530	1620	1715		
40 km/h	780	840	905	965	1025	1085	1150	1210	1270	1355	1435	1520	1600		
50 km/h	780	840	905	965	1025	1085	1150	1210	1270	1355	1435	1520	1600		
65 km/h	655	720	780	845	905	970	1030	1095	1155	1215	1280	1340	1400		

Ø inch	Description	CAI	S mm	OD mm	LR mm	RC mm	Recommended Rim		Acceptable Rim		Tube (Code)	75% internal volume (litres)	Tread depth (mm)		
24	400/80 R24 156A8/151D IND TL 15.5/80 R24 (Equiv 20PR)	920345	413	1240	567	3747	DW13L		DW12 DW14L		703	187	26		
Bar	1.6	1.8	2.0	2.2	2.4	2.6	2.8	3.0	3.2	3.4	3.6	3.8	4.0	4.2	4.4
Psi	23	26	29	32	35	38	41	44	46	49	52	55	58	61	64
Stat	3600	4000	4400	4800	5200	5600	6000	6400	6800	7200	7600	8000	8400	8800	9200
10 km/h Cyc	2340	2600	2860	3125	3385	3645	3905	4165	4430	4690	4950	5215	5475	5740	6000
25 km/h	2120	2285	2450	2610	2775	2940	3100	3265	3430	3665	3905	4140	4375		
30 km/h	2060	2225	2385	2550	2710	2875	3035	3200	3360	3590	3825	4055	4290		
40 km/h	1950	2105	2255	2410	2565	2715	2870	3020	3175	3380	3590	3795	4000		
50 km/h	1950	2105	2255	2410	2565	2715	2870	3020	3175	3380	3590	3795	4000		
65 km/h	1640	1785	1930	2075	2225	2370	2515	2660	2805	2965	3130	3290	3450		

Ø inch	Description	CAI	S mm	OD mm	LR mm	RC mm	Recommended Rim		Acceptable Rim		Tube (Code)	75% internal volume (litres)	Tread depth (mm)		
24	460/70 R24 159A8/154D IND TL NEW 17.5 LR24 (Equiv 18PR)	304047	475	1246	573	3772	DW15L		14 16 DW14L DW16A			217	26		
Bar	1.6	1.8	2.0	2.2	2.4	2.6	2.8	3.0	3.2	3.4	3.6	3.8	4.0	4.2	4.4
Psi	23	26	29	32	35	38	41	44	46	49	52	55	58	61	64
Stat	3940	4375	4815	5250	5690	6125	6560	7000	7435	7875	8310	8750	9185	9625	10060
10 km/h Cyc	2570	2855	3140	3425	3710	3995	4280	4565	4850	5135	5420	5705	5990	6275	6560
25 km/h	2320	2530	2745	2955	3165	3375	3585	3800	4010	4225	4435	4650	4860		
30 km/h	2240	2445	2650	2850	3055	3260	3460	3665	3870	4075	4275	4480	4680		
40 km/h	2120	2310	2505	2695	2885	3075	3270	3460	3650	3830	4015	4195	4375		
50 km/h	2120	2310	2505	2695	2885	3075	3270	3460	3650	3830	4015	4195	4375		
65 km/h	1820	1985	2150	2310	2475	2640	2800	2965	3130	3285	3440	3595	3750		

* Refer to the notes at the end of the tables of this range

MICHELIN CROSSGRIP

Tyre specifications and pressure table (bar & psi). Load per tyre in kg*

Ø inch	Description	CAI	S mm	OD mm	LR mm	RC mm	Recommended Rim	Acceptable Rim	Tube (Code)	75% internal volume (litres)	Tread depth (mm)		
24	440/80 R24 161A8/156D IND TL 16.9 R24 (Equiv 18PR)	131846	447	1314	593	3977	DW14L	DW15L	710	234	26		
Bar	1.6 1.8 2.0	2.2	2.4	2.6	2.8	3.0	3.2	3.4	3.6	3.8	4.0	4.2	4.4
Psi	23 26 29	32	35	38	41	44	46	49	52	55	58	61	64
Stat	4160 4625 5085	5550	6010	6475	6940	7400	7865	8325	8790	9255	9715	10180	10640
10 km/h Cyc	2710 3010 3315	3615	3920	4220	4525	4825	5125	5430	5730	6035	6335	6640	6940
25 km/h	2460 2685 2905	3130	3350	3575	3795	4020	4240	4465	4685	4910	5130		
30 km/h	2370 2585 2800	3015	3230	3445	3660	3875	4090	4305	4520	4735	4950		
40 km/h	2240 2445 2650	2855	3060	3260	3465	3670	3875	4065	4250	4440	4625		
50 km/h	2240 2445 2650	2855	3060	3260	3465	3670	3875	4065	4250	4440	4625		
65 km/h	1880 2050 2220	2390	2560	2725	2895	3065	3235	3425	3615	3800	3990		

Ø inch	Description	CAI	S mm	OD mm	LR mm	RC mm	Recommended Rim	Acceptable Rim	Tube (Code)	75% internal volume (litres)	Tread depth (mm)		
28	400/80 R28 158A8/153D IND TL NEW 14.9 R28	219659	412	1354	615	4094	DW13	W12 W13		159	26		
Bar	1.6 1.8 2.0	2.2	2.4	2.6	2.8	3.0	3.2	3.4	3.6	3.8	4.0	4.2	4.4
Psi	23 26 29	32	35	38	41	44	46	49	52	55	58	61	64
Stat	3830 4255 4680	5105	5530	5955	6375	6800	7225	7650	8075	8500	8925	9350	9775
10 km/h Cyc	2500 2775 3055	3330	3605	3885	4160	4435	4710	4990	5265	5545	5820	6100	6375
25 km/h	2255 2460 2665	2870	3075	3280	3485	3690	3895	4100	4310	4515	4720		
30 km/h	2175 2375 2570	2770	2970	3165	3365	3560	3760	3955	4155	4350	4545		
40 km/h	2060 2245 2430	2615	2805	2990	3175	3360	3545	3720	3900	4075	4250		
50 km/h	2060 2245 2430	2615	2805	2990	3175	3360	3545	3720	3900	4075	4250		
65 km/h	1770 1930 2090	2245	2405	2565	2725	2880	3040	3190	3345	3495	3645		

Ø inch	Description	CAI	S mm	OD mm	LR mm	RC mm	Recommended Rim	Acceptable Rim	Tube (Code)	75% internal volume (litres)	Tread depth (mm)		
28	440/80 R28 163A8/158D IND TL 16.9 R28 (Equiv 18PR)	439765	450	1410	635	4283	DW14L	DW15L	822	259	26		
Bar	1.6 1.8 2.0	2.2	2.4	2.6	2.8	3.0	3.2	3.4	3.6	3.8	4.0	4.2	4.4
Psi	23 26 29	32	35	38	41	44	46	49	52	55	58	61	64
Stat	4370 4930 5485	6045	6605	7165	7720	8280	8840	9395	9955	10515	11075	11630	12190
10 km/h Cyc	2850 3275 3700	4125	4550	4975	5400	5825	6250	6675	7100	7525	7950		
25 km/h	2620 2855 3090	3325	3565	3800	4035	4270	4505	4730	4960	5185	5410		
30 km/h	2525 2750 2975	3200	3425	3645	3870	4095	4320	4545	4770	4990	5215		
40 km/h	2360 2570 2780	2990	3200	3405	3615	3825	4035	4245	4455	4665	4875		
50 km/h	2360 2570 2780	2990	3200	3405	3615	3825	4035	4245	4455	4665	4875		
65 km/h	2035 2210 2390	2565	2745	2920	3095	3275	3450	3650	3850	4050	4250		

* Refer to the notes at the end of the tables of this range

MICHELIN CROSSGRIP

Tyre specifications and pressure table (bar & psi). Load per tyre in kg*

Ø inch	Description	CAI	S mm	OD mm	LR mm	RC mm	Recommended Rim		Acceptable Rim		Tube (Code)	75% internal volume (litres)	Tread depth (mm)
38	480/80 R38 166A8/161D IND TL NEW 18.4 R38	846732	480	1751	791	5272	DW15L				786	416	29
Bar	1.6 1.8 2.0 2.2 2.4 2.6 2.8 3.0 3.2 3.4 3.6 3.8 4.0 4.2 4.4												
Psi	23 26 29 32 35 38 41 44 46 49 52 55 58 61 64												
Stat	5925 6600 7275 7950 8625 9220 9815 10410 11000 11595 12190												
10 km/h Cyc	3865 4305 4745 5185 5625 6015 6400 6790 7175 7565 7950												
25 km/h	3260 3570 3885 4195 4505 4785 5065 5340 5620												
30 km/h	3200 3505 3810 4115 4420 4695 4965 5240 5510												
40 km/h	3075 3370 3665 3955 4250 4515 4775 5040 5300												
50 km/h	3075 3370 3665 3955 4250 4515 4775 5040 5300												
65 km/h	2690 2950 3205 3465 3720 3950 4180 4410 4625												

***IMPORTANT:**

The inflation pressure must always be appropriate for the load per tyre, the speed of travel and the work to be done. Our recommendations above were correct as of the time of publication of these tables (June 2018). Technical data is subject to change without prior notice.

- For use on side slopes: add 0.4 bar.
- For heavy road use, add 0.4 bar.
- Stat: static load.
- 10 km/h Cyc: max. speed 10 km/h with cyclic load.



MICHELIN XF

**RADIAL STEEL
CONSTRUCTION
TO INCREASE TYRE LIFE
& TRACTION**



RADIAL TYRE



COMFORT

- Protection of vehicle & operator



SERVICE LIFE

- Proven casing endurance with robust shoulders



VERSATILITY

- Efficient on all surfaces



100% STEEL CONSTRUCTION

- Great stability
- Excellent puncture resistance and even pressure distribution across the contact patch.



Wheeled
Excavators

SIZES

445/70 R19.5 173A8/180A2 TL

445/70 R22.5 175A8/182A2 TL

MICHELIN XF

Tyre specifications and pressure table (bar & psi). Load per tyre in kg*

Ø inch	Description	CAI	S mm	OD mm	LR mm	RC mm	Recommended Rim		Acceptable Rim		Tube (Code)	75% internal volume (litres)		Tread depth (mm)	
19.5	445/70 R19.5 173A8/180A2 TL 18 R19.5	489102	452	1110	499	3331	14					165		18	
Bar	3.5	3.8	4.0	4.4	4.8	5.2	5.6	6.0	6.2	6.4	6.6	6.8	7.0	7.2	7.5
Psi	51	55	58	64	70	75	81	87	90	93	96	99	102	104	109
Stat	6580	7060	7385	8025	8665	9310	9950	10595	10915	11235	11555	11875	12200	12520	13000
10 km/h	4050	4345	4545	4940	5335	5730	6125	6520	6715	6915	7110	7310	7505	7705	8000
20 km/h	3585	3850	4025	4375	4725	5075	5425	5775	5950	6125	6300	6475	6650	6825	7085
30 km/h	3420	3670	3840	4170	4505	4840	5175	5510	5675	5840	6010	6175	6345	6510	6760
35 km/h	3355	3600	3765	4090	4420	4745	5075	5400	5565	5730	5895	6055	6220	6385	6630
40 km/h	3290	3530	3690	4010	4335	4655	4975	5295	5455	5615	5780	5940	6100	6260	6500

Ø inch	Description	CAI	S mm	OD mm	LR mm	RC mm	Recommended Rim		Acceptable Rim		Tube (Code)	75% internal volume (litres)		Tread depth (mm)	
22.5	445/70 R22.5 175A8/182A2 TL 18 R22.5	073522	452	1192	539	3582	14					191		20	
Bar	3.5	3.8	4.0	4.4	4.8	5.2	5.6	6.0	6.2	6.4	6.6	6.8	7.0	7.2	7.5
Psi	51	55	58	64	70	75	81	87	90	93	96	99	102	104	109
Stat	6980	7490	7835	8515	9195	9880	10560	11245	11585	11925	12265	12605	12950	13290	13800
10 km/h	4300	4615	4825	5245	5665	6085	6505	6925	7135	7345	7555	7765	7975	8185	8500
20 km/h	3805	4085	4270	4640	5010	5385	5755	6125	6315	6500	6685	6870	7055	7240	7520
30 km/h	3635	3900	4080	4435	4785	5140	5495	5850	6030	6205	6380	6560	6735	6915	7180
35 km/h	3560	3820	3995	4345	4690	5040	5385	5735	5910	6085	6255	6430	6605	6780	7040
40 km/h	3490	3745	3915	4255	4600	4940	5280	5620	5790	5960	6135	6305	6475	6645	6900

***IMPORTANT:**

The inflation pressure must always be appropriate for the load per tyre, the speed of travel and the work to be done. Our recommendations above were correct as of the time of publication of these tables (June 2018). Technical data is subject to change without prior notice.

- For use on side slopes: add 0.4 bar.
- For heavy road use, add 0.4 bar.
- Stat: static load.



MICHELIN XM 47

**GREAT ON-ROAD COMFORT
& GOOD GRIP
IN OFF-ROAD CONDITIONS**



RADIAL TYRE for Multi Purpose Off-Road
Vehicles up to 90 km/h*



SPEED

- Designed to operate at speeds up to 90km/h*



ROBUSTNESS

- Reinforced structure resistant to punctures and cuts



SERVICE LIFE

- Proven casing endurance

* Subject to local laws

SIZES

405/70 R20 136G TL

425/75 R20 148G TL

445/70 R24 151G TL

495/70 R24 155G TL

MICHELIN XM 47

Tyre specifications and pressure table (bar & psi). Load per tyre in kg*

Ø inch	Description	CAI	S mm	OD mm	LR mm	RC mm	Recommended Rim		Acceptable Rim		Tube (Code)	75% internal volume (litres)	Tread depth (mm)		
20	405/70 R20 136G TL	123708	395	1076	482	3194	11		11SDC W10		664 ou Joint R1681	137	28		
Bar	1.0	1.2	1.6	1.8	2.0	2.2	2.4	2.6	2.8	3.0	3.2	3.4	3.6	3.8	4.1
Psi	15	17	23	26	29	32	35	38	41	44	46	49	52	55	59
Stat	1950	2185	2655	2890	3125	3365	3600	3835	4070	4305	4540	4775	5010	5245	5600
10 km/h	1400	1570	1910	2080	2250	2420	2590	2755	2925	3095	3265	3435	3605	3775	4030
30 km/h	970	1090	1325	1440	1560	1680	1795	1915	2035	2150	2270	2385	2505	2625	2800
40 km/h	900	1010	1225	1335	1440	1550	1660	1765	1875	1985	2090	2200	2310	2415	2580
65 km/h	850	950	1155	1260	1360	1460	1565	1665	1765	1870	1970	2075	2175	2275	2430
90 km/h	780	875	1065	1155	1250	1345	1440	1535	1630	1720	1815	1910	2005	2100	2240

Ø inch	Description	CAI	S mm	OD mm	LR mm	RC mm	Recommended Rim		Acceptable Rim		Tube (Code)	75% internal volume (litres)	Tread depth (mm)		
20	425/75 R20 148G TL	123706	450	1147	509	3398	13		11 11SDC 13SDC		664 ou Joint R1681	185	30		
Bar	1.0	1.2	1.6	1.8	2.0	2.2	2.4	2.6	2.8	3.0	3.2	3.4	3.6	3.8	4.1
Psi	15	17	23	26	29	32	35	38	41	44	46	49	52	55	59
Stat	2750	3080	3740	4075	4405	4735	5065	5395	5725	6055	6385	6720	7050	7380	7875
10 km/h	1970	2210	2685	2925	3165	3400	3640	3880	4120	4355	4595	4835	5075	5310	5670
30 km/h	1370	1535	1865	2035	2200	2365	2530	2695	2860	3030	3195	3360	3525	3690	3940
40 km/h	1260	1410	1715	1870	2020	2175	2325	2480	2630	2785	2935	3085	3240	3390	3620
65 km/h	1190	1335	1620	1765	1910	2055	2195	2340	2485	2630	2775	2915	3060	3205	3420
90 km/h	1100	1230	1495	1630	1760	1895	2025	2160	2290	2425	2555	2685	2820	2950	3150

Ø inch	Description	CAI	S mm	OD mm	LR mm	RC mm	Recommended Rim		Acceptable Rim		Tube (Code)	75% internal volume (litres)	Tread depth (mm)		
24	445/70 R24 151G TL	123642	462	1239	562	3689	DW15L		DW14L W14L W15L		710	210	34		
Bar	1.0	1.2	1.6	1.8	2.0	2.2	2.4	2.6	2.8	3.0	3.2	3.4	3.6	3.8	4.1
Psi	15	17	23	26	29	32	35	38	41	44	46	49	52	55	59
Stat	3000	3365	4090	4450	4815	5175	5540	5905	6265	6630	6990	7355	7720	8080	8625
10 km/h	2160	2420	2945	3205	3465	3730	3990	4250	4510	4775	5035	5295	5555	5820	6210
30 km/h	1500	1680	2045	2225	2405	2590	2770	2950	3130	3315	3495	3675	3855	4040	4310
40 km/h	1380	1545	1880	2050	2215	2385	2550	2715	2885	3050	3220	3385	3550	3720	3970
65 km/h	1300	1455	1770	1930	2085	2245	2400	2560	2715	2875	3030	3190	3345	3505	3740
90 km/h	1200	1345	1635	1780	1925	2070	2215	2360	2505	2650	2795	2940	3085	3230	3450

* Refer to the notes at the end of the tables of this range

MICHELIN XM 47

Tyre specifications and pressure table (bar & psi). Load per tyre in kg*

Ø inch	Description	CAI	S mm	OD mm	LR mm	RC mm	Recommended Rim		Acceptable Rim		Tube (Code)	75% internal volume (litres)		Tread depth (mm)	
24	495/70 R24 155G TL	123620	508	1311	581	3883	DW16L		W16L		710	248		35	
Bar	1.0 1.2 1.6 1.8 2.0 2.2 2.4 2.6 2.8 3.0 3.2 3.4 3.6 3.8 4.1														
Psi	15 17 23 26 29 32 35 38 41 44 46 49 52 55 59														
Stat	3375 3785 4600 5005 5415 5825 6230 6640 7050 7455 7865 8270 8680 9090 9700														
10 km/h	2430 2725 3310 3605 3900 4190 4485 4780 5070 5365 5660 5955 6245 6540 6980														
30 km/h	1690 1895 2300 2505 2705 2910 3115 3315 3520 3720 3925 4130 4330 4535 4840														
40 km/h	1550 1740 2115 2300 2490 2675 2865 3050 3240 3425 3615 3805 3990 4180 4460														
65 km/h	1460 1635 1990 2165 2345 2520 2695 2875 3050 3230 3405 3580 3760 3935 4200														
90 km/h	1350 1515 1840 2005 2165 2330 2495 2655 2820 2980 3145 3310 3470 3635 3880														

***IMPORTANT:**

The inflation pressure must always be appropriate for the load per tyre, the speed of travel and the work to be done. Our recommendations above were correct as of the time of publication of these tables (June 2018). Technical data is subject to change without prior notice.

- For use on side slopes: add 0.4 bar.
- For heavy road use, add 0.4 bar.
- Stat: static load.



MICHELIN BIBSTEEL ALL TERRAIN

**REINFORCED RADIAL
CONSTRUCTION/EXCELLENT
TRACTION ON SOFT GROUND**



COMFORT

- Protection of vehicle & operator



TRACTION

- Radial construction & open tread pattern



ROBUSTNESS

- 100% steel construction for puncture resistance



SERVICE LIFE

- Proven casing endurance



100% STEEL CONSTRUCTION

- Great stability
- Excellent puncture resistance and even pressure distribution across the contact patch.



Skid Steer



Telehandlers

SIZES

210/70 R15 117A8/117B IND TL

260/70 R16.5 129A8/129B IND TL

300/70 R16.5 137A8/137B IND TL

360/70 R17.5 148A8/148B IND TL

MICHELIN BIBSTEEL ALL TERRAIN

Tyre specifications and pressure table (bar & psi). Load per tyre in kg*

Ø inch	Description	CAI	S mm	OD mm	LR mm	RC mm	Recommended Rim		Acceptable Rim		Tube (Code)	75% internal volume (litres)	Tread depth (mm)			
15	210/70 R15 117A8/117B IND TL (27 x 8.50 R15) Equiv 8PR Replaces size 215/70 R15	085459	209	680	314	2033	7					26	15			
	Bar	1.5	1.8	2.2	2.6	3.0	3.2	3.4	3.6	3.8	4.0	4.2	4.4	4.6	4.8	5.0
	Psi	22	26	32	38	44	46	49	52	55	58	61	64	67	70	73
	Stat	1100	1270	1485	1695	1905	2010	2115	2220	2325	2430	2535	2640	2745	2850	2955
	25 km/h	530	615	720	820	920	970	1020	1070	1125	1175	1225	1275	1330	1380	1430
	40 km/h	475	550	645	740	830	875	920	965	1010	1055	1105	1150	1195	1240	1285
	50 km/h	475	550	645	740	830	875	920	965	1010	1055	1105	1150	1195	1240	1285

Ø inch	Description	CAI	S mm	OD mm	LR mm	RC mm	Recommended Rim		Acceptable Rim		Tube (Code)	75% internal volume (litres)	Tread depth (mm)			
16.5	260/70 R16.5 129A8/129B IND TL (10 R16.5) Equiv 12PR Replaces size 265/70 R16.5	176281	263	774	355	2310	8.25				184	47	20			
	Bar	1.5	1.8	2.2	2.6	3.0	3.2	3.4	3.6	3.8	4.0	4.2	4.4	4.6	4.8	5.0
	Psi	22	26	32	38	44	46	49	52	55	58	61	64	67	70	73
	Stat	1590	1810	2110	2415	2720	2870	3025	3180	3330	3485	3640	3795	3945	4100	4255
	25 km/h	760	870	1015	1165	1315	1390	1465	1540	1610	1685	1760	1835	1905	1980	2055
	40 km/h	690	785	915	1050	1185	1250	1315	1385	1450	1515	1585	1650	1715	1785	1850
	50 km/h	690	785	915	1050	1185	1250	1315	1385	1450	1515	1585	1650	1715	1785	1850

Ø inch	Description	CAI	S mm	OD mm	LR mm	RC mm	Recommended Rim		Acceptable Rim		Tube (Code)	75% internal volume (litres)	Tread depth (mm)			
16.5	300/70 R16.5 137A8/137B IND TL (12 R16.5) Equiv 14PR	625787	311	832	380	2481	9,75					65	23			
	Bar	1.5	1.8	2.2	2.6	3.0	3.2	3.4	3.6	3.8	4.0	4.2	4.4	4.6	4.8	5.0
	Psi	22	26	32	38	44	46	49	52	55	58	61	64	67	70	73
	Stat	2010	2270	2630	3005	3380	3565	3755	3950	4140	4330	4525	4715	4905	5100	5290
	25 km/h	970	1095	1270	1450	1630	1720	1810	1905	1995	2090	2180	2275	2365	2460	2550
	40 km/h	875	985	1140	1305	1470	1550	1635	1715	1800	1885	1965	2050	2135	2215	2300
	50 km/h	875	985	1140	1305	1470	1550	1635	1715	1800	1885	1965	2050	2135	2215	2300

Ø inch	Description	CAI	S mm	OD mm	LR mm	RC mm	Recommended Rim		Acceptable Rim		Tube (Code)	75% internal volume (litres)	Tread depth (mm)			
17.5	360/70 R17.5 148A8/148B IND TL (14 R17.5) Equiv 14PR	360353	351	949	429	2823	10.5					99	26			
	Bar	1.5	1.8	2.2	2.6	3.0	3.2	3.4	3.6	3.8	4.0	4.2	4.4	4.6	4.8	5.0
	Psi	22	26	32	38	44	46	49	52	55	58	61	64	67	70	73
	Stat	2715	3105	3620	4140	4660	4920	5175	5435	5695	5955	6215	6475	6730	6990	7250
	25 km/h	1300	1490	1740	1990	2245	2370	2495	2620	2745	2870	2995	3125	3250	3375	3500
	40 km/h	1180	1350	1575	1800	2025	2135	2250	2360	2475	2585	2700	2810	2925	3035	3150
	50 km/h	1180	1350	1575	1800	2025	2135	2250	2360	2475	2585	2700	2810	2925	3035	3150

* Refer to the notes at the end of the tables of this range

MICHELIN BIBSTEEL ALL TERRAIN

Tyre specifications and pressure table (bar & psi). Load per tyre in kg*

***IMPORTANT:**

The inflation pressure must always be appropriate for the load per tyre, the speed of travel and the work to be done. Our recommendations above were correct as of the time of publication of these tables (June 2018).
Technical data is subject to change without prior notice.

- For use on side slopes: add 0.4 bar.
- For heavy road use, add 0.4 bar.
- Stat: static load.



MICHELIN BIBSTEEL HARD SURFACE

**REINFORCED RADIAL
CONSTRUCTION/MORE
TRACTION ON TOUGH &
ABRASIVE SURFACES**



RADIAL TYRE



COMFORT

- Protection of vehicle & operator



ROBUSTNESS

- 100% steel construction for puncture resistance
- Thick sidewall and protective trash guard



SERVICE LIFE

- Proven casing endurance



100% STEEL CONSTRUCTION

- Great stability
- Excellent puncture resistance and even pressure distribution across the contact patch.



Skid Steer



Telehandlers

SIZES

260/70 R16.5 129A8/129B IND TL

300/70 R16.5 137A8/137B IND TL

MICHELIN BIBSTEEL HARD SURFACE

Tyre specifications and pressure table (bar & psi). Load per tyre in kg*

Ø inch	Description	CAI	S mm	OD mm	LR mm	RC mm	Recommended Rim		Acceptable Rim		Tube (Code)	75% internal volume (litres)	Tread depth (mm)		
16.5	260/70 R16.5 129A8/129B IND TL (10 R16.5) Equiv 12PR	275538	266	773	355	2307	8.25					45	18		
Bar	1.5	1.8	2.2	2.6	3.0	3.2	3.4	3.6	3.8	4.0	4.2	4.4	4.6	4.8	5.0
Psi	22	26	32	38	44	46	49	52	55	58	61	64	67	70	73
Stat	1590	1810	2110	2415	2720	2870	3025	3180	3330	3485	3640	3795	3945	4100	4255
25 km/h	760	870	1015	1165	1315	1390	1465	1540	1610	1685	1760	1835	1905	1980	2055
40 km/h	690	785	915	1050	1185	1250	1315	1385	1450	1515	1585	1650	1715	1785	1850
50 km/h	690	785	915	1050	1185	1250	1315	1385	1450	1515	1585	1650	1715	1785	1850

Ø inch	Description	CAI	S mm	OD mm	LR mm	RC mm	Recommended Rim		Acceptable Rim		Tube (Code)	75% internal volume (litres)	Tread depth (mm)		
16.5	300/70 R16.5 137A8/137B IND TL (12 R16.5) Equiv 14PR	241265	315	830	378	2477	9.75					65	21		
Bar	1.5	1.8	2.2	2.6	3.0	3.2	3.4	3.6	3.8	4.0	4.2	4.4	4.6	4.8	5.0
Psi	22	26	32	38	44	46	49	52	55	58	61	64	67	70	73
Stat	2010	2270	2630	3005	3380	3565	3755	3950	4140	4330	4525	4715	4905	5100	5290
25 km/h	970	1095	1270	1450	1630	1720	1810	1905	1995	2090	2180	2275	2365	2460	2550
40 km/h	875	985	1140	1305	1470	1550	1635	1715	1800	1885	1965	2050	2135	2215	2300
50 km/h	875	985	1140	1305	1470	1550	1635	1715	1800	1885	1965	2050	2135	2215	2300

***IMPORTANT:**

The inflation pressure must always be appropriate for the load per tyre, the speed of travel and the work to be done. Our recommendations above were correct as of the time of publication of these tables (June 2018). Technical data is subject to change without prior notice.

- For use on side slopes: add 0.4 bar.
- For heavy road use, add 0.4 bar.
- Stat: static load.



MICHELIN X TWEEL

**THE AIRLESS RADIAL TYRE
& WHEEL ASSEMBLY**

NO MAINTENANCE:

- One single unit, replacing the current tyre/wheel/valve assembly
- No need for complex wheel/tyre mounting equipment
- No air pressure to maintain

NO COMPROMISE:

- Productivity increased
- Greater stability
- More comfort for the operator
- Long tread life



Skid Steer

VEHICLE AVAILABILITY:

- No puncture risk and costly downtime associated

CAI MSPN	Description	Size	Max load at 15 km/h kg lbs	Section width mm inches	Overall diameter mm inches	Rolling circum. mm inches	Static loaded radius mm inches	Tread depth mm 32nds
357108 34735	XTWEEL SSL All Terrain	12N16.5	1995 4400	307 12.1	841 33.1	2405 94.7	401 15.8	25 31
040921 64828	XTWEEL SSL Hard Surface Traction	12N16.5	1995 4400	307 12.1	861 33.9	2405 94.7	409 16.1	38 50
297671 37131	XTWEEL SSL All Terrain	10N16.5	1678 3700	257 10.1	767 30.2	2205 86.8	358 14.1	25 31



MICHELIN POWER CL

**CROSS PLY TYRE.
RESISTANT TO CUTS
WITH GREAT STABILITY**



ROBUSTNESS

- 6 to 8 ply casing
- Resistant to shocks, punctures and cuts



CROSS PLY Tyre

- Vertical & lateral stability



SERVICE LIFE

- Massive lugs for grip on hard surfaces



Backhoe loaders



Compact Wheel Loaders



Telehandlers

SIZES

280/80 -18 132A8 IND TL

340/80 -18 143A8 IND TL

280/80 -20 133A8 IND TL

340/80 -20 144A8 IND TL

400/70 -20 149A8 IND TL

400/70 -24 158A8 IND TL

460/70 -24 159A8 IND TL

400/80 -24 162A8 IND TL

500/70 -24 164A8 IND TL

440/80 -24 168A8 IND TL

480/80 -26 167A8 IND TL

440/80 -28 163 A8 IND TL

420/80 -30 155A8 IND TL

MICHELIN POWER CL

Tyre specifications and pressure table (bar & psi). Load per tyre in kg*

Ø inch	Description	CAI	S mm	OD mm	LR mm	RC mm	Recommended Rim		Acceptable Rim	Tube (Code)	75% internal volume (litres)	Tread depth (mm)				
18	280/80 -18 132A8 IND TL <i>10.5/80 - 18 (Equip 10PR)</i>	281778	288	902	413	2691	9		10 W10 W8 W9	438	80	26				
	Bar	1.0	1.2	1.6	2.0	2.4	2.8	3.2	3.6	3.8	4.0	4.2	4.4	4.6	4.8	5.0
	Psi	15	17	23	29	35	41	46	52	55	58	61	64	67	70	73
	Stat	1840	2025	2390	2760	3130	3495	3865	4230	4415	4600					
	10 km/h Cyc	1200	1320	1560	1800	2040	2280	2520	2760	2880	3000					
	10 km/h	1000	1100	1300	1500	1700	1900	2100	2300	2400	2500					
	25 km/h	850	935	1105	1275	1445	1610	1780	1950	2035	2120					
	30 km/h	830	915	1080	1245	1415	1580	1745	1915	1995	2080					
	40 km/h	800	880	1040	1200	1360	1520	1680	1840	1920	2000					

Ø inch	Description	CAI	S mm	OD mm	LR mm	RC mm	Recommended Rim		Acceptable Rim	Tube (Code)	75% internal volume (litres)	Tread depth (mm)				
18	340/80 -18 143A8 IND TL <i>12.5/80 - 18 (Equip 12PR)</i>	610873	353	1006	452	2988	11		10 11SDC 12 12SDC W10 W11	828 444	106	24				
	Bar	1.0	1.2	1.6	2.0	2.4	2.8	3.2	3.6	3.8	4.0	4.2	4.4	4.6	4.8	5.0
	Psi	15	17	23	29	35	41	46	52	55	58	61	64	67	70	73
	Stat	2510	2760	3260	3765	4265	4765	5265	5770	6020	6270					
	10 km/h Cyc	1640	1805	2130	2455	2785	3110	3435	3765	3925	4090					
	10 km/h	1360	1495	1770	2045	2315	2590	2865	3135	3275	3410					
	25 km/h	1155	1270	1505	1735	1965	2200	2430	2665	2780	2895					
	30 km/h	1130	1245	1470	1695	1925	2150	2375	2605	2715	2830					
	40 km/h	1090	1200	1420	1635	1855	2075	2295	2510	2620	2730					

Ø inch	Description	CAI	S mm	OD mm	LR mm	RC mm	Recommended Rim		Acceptable Rim	Tube (Code)	75% internal volume (litres)	Tread depth (mm)				
20	280/80 -20 133A8 IND TL <i>10.5/80 - 20 (Equip 10PR)</i>	694767	287	947	435	2828	9		10 W10 W8 W9	542	86	27				
	Bar	1.0	1.2	1.6	2.0	2.4	2.8	3.2	3.6	3.8	4.0	4.2	4.4	4.6	4.8	5.0
	Psi	15	17	23	29	35	41	46	52	55	58	61	64	67	70	73
	Stat	1900	2090	2470	2845	3225	3605	3985	4360	4550	4740					
	10 km/h Cyc	1240	1365	1610	1855	2105	2350	2595	2845	2965	3090					
	10 km/h	1030	1135	1340	1545	1755	1960	2165	2375	2475	2580					
	25 km/h	870	960	1135	1310	1485	1660	1835	2010	2095	2185					
	30 km/h	860	945	1115	1285	1455	1630	1800	1970	2055	2140					
	40 km/h	820	905	1070	1235	1400	1565	1730	1895	1975	2060					

* Refer to the notes at the end of the tables of this range

MICHELIN POWER CL

Tyre specifications and pressure table (bar & psi). Load per tyre in kg*

Ø inch	Description	CAI	S mm	OD mm	LR mm	RC mm	Recommended Rim		Acceptable Rim	Tube (Code)	75% internal volume (litres)	Tread depth (mm)				
20	340/80 -20 144A8 IND TL 12.5/80 - 20 (Equip 12PR)	495503	337	1045	474	3112	11		10 11SDC 12 12SDC W10 W11	664 444	113	25				
	Bar	1.0	1.2	1.6	2.0	2.4	2.8	3.2	3.6	3.8	4.0	4.2	4.4	4.6	4.8	5.0
	Psi	15	17	23	29	35	41	46	52	55	58	61	64	67	70	73
	Stat	2580	2835	3350	3865	4380	4895	5410	5925	6185	6440					
	10 km/h Cyc	1680	1850	2185	2520	2855	3190	3530	3865	4030	4200					
	10 km/h	1400	1540	1820	2100	2380	2660	2940	3220	3360	3500					
	25 km/h	1185	1305	1540	1780	2020	2255	2495	2730	2850	2970					
	30 km/h	1160	1275	1510	1745	1975	2210	2445	2675	2795	2910					
	40 km/h	1120	1230	1455	1680	1905	2130	2350	2575	2690	2800					

Ø inch	Description	CAI	S mm	OD mm	LR mm	RC mm	Recommended Rim		Acceptable Rim	Tube (Code)	75% internal volume (litres)	Tread depth (mm)				
20	400/70 -20 149A8 IND TL 16.0/70 - 20 / 405/70 - 20 (Equip 16PR)	346809	405	1065	480	3167	13		12 12SDC 13SDC 14	664	129	29				
	Bar	1.0	1.2	1.6	2.0	2.4	2.8	3.2	3.6	3.8	4.0	4.2	4.4	4.6	4.8	5.0
	Psi	15	17	23	29	35	41	46	52	55	58	61	64	67	70	73
	Stat	2990	3290	3890	4485	5085	5685	6285	6880	7180	7480					
	10 km/h Cyc	1950	2145	2535	2925	3315	3710	4100	4490	4685	4880					
	10 km/h	1630	1790	2115	2440	2765	3090	3410	3735	3900	4060					
	25 km/h	1380	1520	1795	2070	2345	2620	2895	3170	3305	3445					
	30 km/h	1350	1485	1755	2025	2295	2570	2840	3110	3245	3380					
	40 km/h	1300	1430	1690	1950	2210	2470	2730	2990	3120	3250					

Ø inch	Description	CAI	S mm	OD mm	LR mm	RC mm	Recommended Rim		Acceptable Rim	Tube (Code)	75% internal volume (litres)	Tread depth (mm)				
24	400/70 -24 158A8 IND TL 16.0/70 - 24 / 405/70 - 24 (Equip 20PR)	407878	418	1173	535	3497	DW13		13 14 DW14L	703	165	29				
	Bar	1.0	1.2	1.6	2.0	2.4	2.8	3.2	3.6	3.8	4.0	4.2	4.4	4.6	4.8	5.0
	Psi	15	17	23	29	35	41	46	52	55	58	61	64	67	70	73
	Stat	3290	3615	4265	4910	5560	6210	6855	7505	7830	8155	8480	8800	9125	9450	9775
	10 km/h Cyc	2145	2355	2780	3205	3625	4050	4470	4895	5105	5320	5530	5740	5950	6165	6375
	10 km/h	1790	1965	2320	2670	3025	3375	3730	4080	4260	4435	4610	4785	4965	5140	5315
	25 km/h	1515	1665	1965	2265	2560	2860	3160	3460	3610	3760	3905	4055	4205	4355	4505
	30 km/h	1485	1630	1925	2220	2510	2805	3100	3395	3540	3685	3835	3980	4125	4275	4420
	40 km/h	1430	1570	1855	2135	2415	2700	2980	3265	3405	3545	3685	3825	3970	4110	4250

* Refer to the notes at the end of the tables of this range

MICHELIN POWER CL

Tyre specifications and pressure table (bar & psi). Load per tyre in kg*

Ø inch	Description	CAI	S mm	OD mm	LR mm	RC mm	Recommended Rim		Acceptable Rim	Tube (Code)	75% internal volume (litres)	Tread depth (mm)	
24	460/70 -24 159A8 IND TL 17.5 L - 24 (Equiv 18PR)	474764	457	1241	558	3687	DW15L		14 16 DW14L DW16L	710	217	29	
Bar	1.0 1.2 1.6	2.0	2.4	2.8	3.2	3.6	3.8	4.0	4.2	4.4	4.6	4.8	5.0
Psi	15 17 23	29	35	41	46	52	55	58	61	64	67	70	73
Stat	3450 3890 4770	5655	6535	7415	8295	9180	9620	10060					
10 km/h Cyc	2250 2535 3110	3685	4260	4835	5410	5985	6275	6560					
10 km/h	1875 2115 2595	3075	3555	4030	4510	4990	5230	5470					
25 km/h	1590 1795 2200	2605	3015	3420	3825	4235	4435	4640					
30 km/h	1560 1760 2160	2555	2955	3355	3755	4150	4350	4550					
40 km/h	1500 1690 2075	2460	2840	3225	3610	3990	4185	4375					

Ø inch	Description	CAI	S mm	OD mm	LR mm	RC mm	Recommended Rim		Acceptable Rim	Tube (Code)	75% internal volume (litres)	Tread depth (mm)	
24	400/80 -24 162A8 IND TL 15.5/80 -24 (Equiv 20 PR)	050267	414	1257	571	3743	DW13		DW14L, 13, 14, TW14L	703	187	29	
Bar	1.0 1.2 1.6	2.0	2.4	2.8	3.2	3.6	3.8	4.0	4.2	4.4	4.6	4.8	5.0
Psi	15 17 23	29	35	41	46	52	55	58	61	64	67	70	73
Stat	3680 4045 4770	5495	6220	6945	7670	8395	8755	9120	9480	9845	10205	10570	10930
10 km/h Cyc	2400 2635 3110	3585	4055	4530	5000	5475	5710	5950	6185	6420	6655	6895	7130
10 km/h Cyc Dual	1500 1625 1875	2125	2375	2625	2875	3125	3250	3375	3500	3625	3750	3875	4000
10 km/h	2000 2195 2590	2985	3380	3775	4165	4560	4760	4955	5150	5350	5545	5745	5940
25 km/h	1695 1860 2195	2530	2865	3200	3530	3865	4035	4200	4365	4535	4700	4870	5035
30 km/h	1660 1825 2150	2480	2810	3135	3465	3790	3955	4120	4285	4450	4610	4775	4940
40 km/h	1600 1760 2075	2390	2705	3020	3335	3650	3805	3965	4120	4280	4435	4595	4750
30 km/h FRT	3000 3050 3150	3250	3350	3450	3550	3650	3700	3750	3800	3850	3900	3950	4000

Ø inch	Description	CAI	S mm	OD mm	LR mm	RC mm	Recommended Rim		Acceptable Rim	Tube (Code)	75% internal volume (litres)	Tread depth (mm)	
24	500/70 -24 164A8 IND TL 19.5 L - 24 (Equiv 20PR)	196220	504	1315	588	3903	DW16L		16 DW15L	710	264	29	
Bar	1.0 1.2 1.6	2.0	2.4	2.8	3.2	3.6	3.8	4.0	4.2	4.4	4.6	4.8	5.0
Psi	15 17 23	29	35	41	46	52	55	58	61	64	67	70	73
Stat	3910 4415 5430	6440	7450	8465	9475	10490	10995	11500					
10 km/h Cyc	2550 2880 3540	4200	4860	5520	6180	6840	7170	7500					
10 km/h	2125 2400 2950	3500	4050	4600	5150	5700	5975	6250					
25 km/h	1800 2035 2500	2965	3435	3900	4365	4835	5065	5300					
30 km/h	1770 2000 2455	2915	3370	3830	4285	4745	4970	5200					
40 km/h	1700 1920 2360	2800	3240	3680	4120	4560	4780	5000					

* Refer to the notes at the end of the tables of this range

MICHELIN POWER CL

Tyre specifications and pressure table (bar & psi). Load per tyre in kg*

Ø inch	Description	CAI	S mm	OD mm	LR mm	RC mm	Recommended Rim		Acceptable Rim		Tube (Code)	75% internal volume (litres)	Tread depth (mm)			
24	440/80 -24 168A8 IND TL <i>16.9 - 24 / 16.5/85 - 24 (Equiv 22PR)</i>	165629	460	1328	596	3944	DW15L		14 DW13 DW14L		710	236	29			
	Bar	1.0	1.2	1.6	2.0	2.4	2.8	3.2	3.6	3.8	4.0	4.2	4.4	4.6	4.8	5.0
	Psi	15	17	23	29	35	41	46	52	55	58	61	64	67	70	73
	Stat	4340	4765	5620	6475	7330	8185	9035	9890	10320	10745	11170	11600	12025	12455	12880
	10 km/h Cyc	2830	3110	3665	4225	4780	5335	5895	6450	6730	7010	7285	7565	7845	8120	8400
	10 km/h	2360	2590	3055	3520	3985	4450	4910	5375	5610	5840	6070	6305	6535	6770	7000
	25 km/h	2005	2200	2595	2990	3380	3775	4165	4560	4755	4955	5150	5345	5540	5740	5935
	30 km/h	1960	2155	2540	2925	3310	3695	4085	4470	4660	4855	5050	5240	5435	5625	5820
	40 km/h	1890	2075	2445	2820	3190	3560	3930	4300	4485	4675	4860	5045	5230	5415	5600

Ø inch	Description	CAI	S mm	OD mm	LR mm	RC mm	Recommended Rim		Acceptable Rim		Tube (Code)	75% internal volume (litres)	Tread depth (mm)			
26	480/80 -26 167A8 IND TL <i>18.4 - 26 (Equiv 20PR)</i>	226486	504	1417	637	4211	DW16L		DW15L		716	302	28			
	Bar	1.0	1.2	1.6	2.0	2.4	2.8	3.2	3.6	3.8	4.0	4.2	4.4	4.6	4.8	5.0
	Psi	15	17	23	29	35	41	46	52	55	58	61	64	67	70	73
	Stat	4920	5415	6400	7390	8375	9365	10350	11445	11990	12535					
	10 km/h Cyc	3210	3530	4175	4820	5465	6105	6750	7465	7820	8175					
	10 km/h	2670	2940	3475	4015	4555	5090	5630	6225	6520	6815					
	25 km/h	2270	2495	2950	3405	3860	4315	4770	5275	5530	5780					
	30 km/h	2220	2445	2890	3340	3785	4235	4680	5175	5425	5670					
	40 km/h	2140	2355	2785	3215	3640	4070	4500	4975	5215	5450					

Ø inch	Description	CAI	S mm	OD mm	LR mm	RC mm	Recommended Rim		Acceptable Rim		Tube (Code)	75% internal volume (litres)	Tread depth (mm)			
28	440/80 -28 163 A8 IND TL <i>16.9 - 28 / 16.5/85 - 28 (Equiv 18PR)</i>	691578	449	1412	642	4201	DW15L		DW13 DW14L		822	259	29			
	Bar	1.0	1.2	1.6	2.0	2.4	2.8	3.2	3.6	3.8	4.0	4.2	4.4	4.6	4.8	5.0
	Psi	15	17	23	29	35	41	46	52	55	58	61	64	67	70	73
	Stat	4370	4810	5685	6565	7445	8320	9200	10210	10710	11215					
	10 km/h Cyc	2850	3135	3710	4280	4855	5425	6000	6660	6985	7315					
	10 km/h	2375	2615	3090	3570	4045	4525	5000	5550	5820	6095					
	25 km/h	2015	2215	2620	3025	3430	3835	4240	4705	4940	5170					
	30 km/h	1975	2175	2570	2970	3365	3765	4160	4615	4845	5070					
	40 km/h	1900	2090	2475	2855	3235	3620	4000	4440	4655	4875					

* Refer to the notes at the end of the tables of this range

MICHELIN POWER CL

Tyre specifications and pressure table (bar & psi). Load per tyre in kg*

Ø inch	Description	CAI	S mm	OD mm	LR mm	RC mm	Recommended Rim		Acceptable Rim		Tube (Code)	75% internal volume (litres)	Tread depth (mm)
30	420/80 -30 155A8 IND TL <i>16,9 - 30 (Equiv 14PR)</i>	577845	432	1432	656	4296	DW15L		DW13 DW14L		754	245	36
Bar	1.0 1.2 1.6 2.0 2.4 2.8 3.2						3.6 3.8	4.0 4.2	4.4 4.6 4.8 5.0				
Psi	15 17 23 29 35 41 46						52 55	58 61	64 67 70 73				
10 km/h Cyc	2760	3040	3595	4150	4705	5260	5815						
10 km/h	2300	2530	2995	3455	3920	4380	4845						
25 km/h	1950	2145	2540	2930	3325	3715	4110						
30 km/h	1915	2105	2490	2875	3260	3645	4030						
40 km/h	1840	2025	2395	2765	3135	3505	3875						

***IMPORTANT:**

The inflation pressure must always be appropriate for the load per tyre, the speed of travel and the work to be done. Our recommendations above were correct as of the time of publication of these tables (June 2018). Technical data is subject to change without prior notice.

- For use on side slopes: add 0.4 bar.
- For heavy road use, add 0.4 bar.
- Stat: static load.
- 10 km/h Cyc: max. speed 10 km/h with cyclic load.



MICHELIN POWER DIGGER

*SUPERB PRODUCTIVITY
THROUGHOUT THE TYRE'S
LIFE*



PROFITABILITY

- Great load index (147B) & improved wear resistance



ROBUSTNESS

- +2 casing plies*



STABILITY

- +57% sidewall thickness. Based on Power CL Technology



Wheeled
Excavators

* Vs equivalent MITAS Bias tyre

SIZES

10.00-20 165A2/147B 16PR TT

MICHELIN POWER DIGGER

Tyre specifications and pressure table (bar & psi). Load per tyre in kg*

Ø inch	Description			CAI	S mm	OD mm	LR mm	RC mm	Recommended Rim		Acceptable Rim		Tube (Code)	75% internal volume (litres)	Tread depth (mm)
20	10.00-20 165A2/147B 16PR TT			263208	286	1050	488	3144	7.5T				20N	53	15
Bar	4.0	4.4	4.8	5.2	5.6	6.0	6.4	6.6	6.8	7.0	7.2	7.4	7.6	7.8	8.0
Psi	58	64	70	75	81	87	93	96	99	102	104	107	110	113	116
Stat	4000	4380	4760	5140	5520	5900	6260	6440	6620	6800	6980	7160	7340	7515	7690
10 km/h	2670	2925	3180	3430	3685	3940	4180	4300	4425	4545	4665	4785	4905	5030	5150
20 km/h	2130	2330	2535	2735	2940	3140	3330	3425	3520	3615	3710	3805	3900	3995	4090
30 km/h	1745	1910	2075	2240	2405	2570	2725	2805	2885	2965	3040	3120	3200	3285	3370
35 km/h	1630	1785	1940	2095	2250	2405	2555	2625	2700	2775	2850	2925	2995	3065	3135
50 km/h	1360	1560	1760	1960	2160	2360	2505	2575	2650	2720	2790	2865	2935	3005	3075

MICHELIN POWER DIGGER Accessories:

- Triple bend valve stem tube (CAI: 101162)
- Flap with plastic plate (CAI: 320222)

*IMPORTANT:

The inflation pressure must always be appropriate for the load per tyre, the speed of travel and the work to be done. Our recommendations above were correct as of the time of publication of these tables (June 2018). Technical data is subject to change without prior notice.

• Stat: static load.

MICHELIN AGRICULTURE

USING AGRICULTURAL TYRES | 2019



AGRICULTURAL.MICHELIN.CO.UK

MICHELIN

CONTENTS

SELECT A TYRE, USE AND OPERATION	175
TYRE MARKINGS	176
LOAD INDICES AND SPEED RATINGS	177
OPERATING INSTRUCTIONS	178
CALCULATION OF MECHANICAL LEAD	179
FRONT WHEEL LEAD % MEASUREMENT	180
LOAD-BALANCING CALCULATION	181
RIM AND O-RING REFERENCES	183
INNER TUBE AND VALVE REFERENCES	184
VALVE CHARACTERISTICS	188
INSTRUCTIONS FOR REMOVING / FITTING TYRES	190

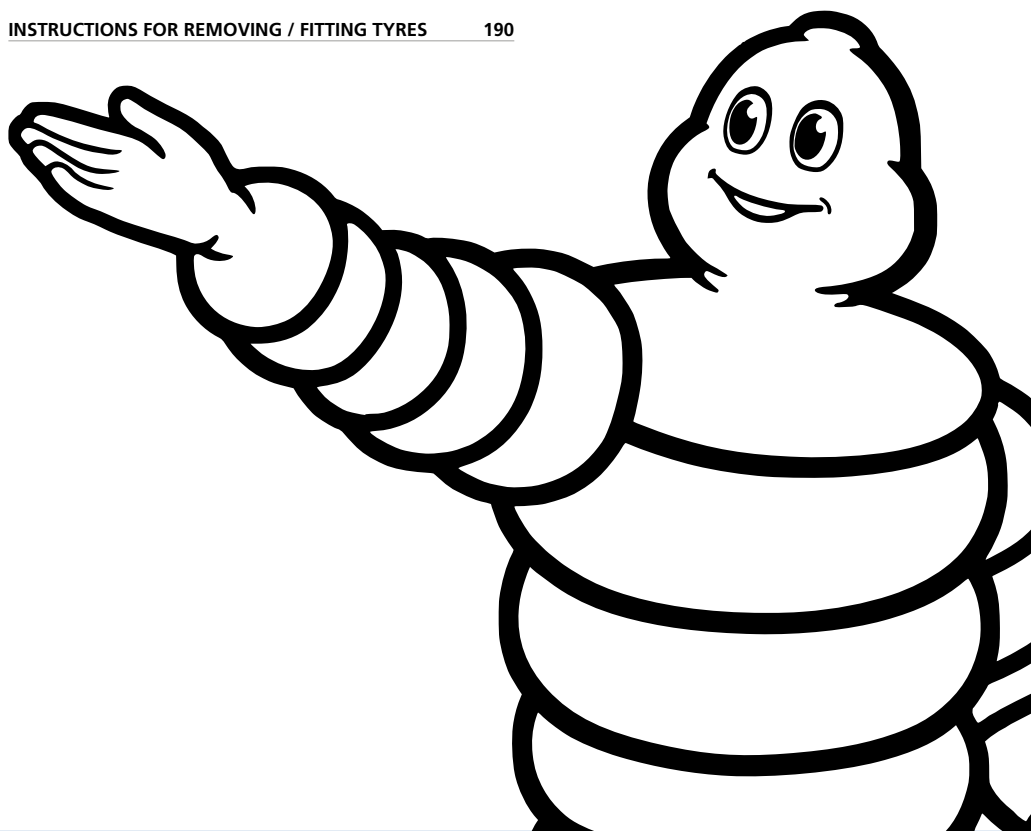

SELECT A TYRE, USE AND OPERATION

Tyre choice must comply with the applicable legislation and the recommended equipment defined by the manufacturer or by an official body (tyre size, load and speed indices, construction (radial, cross-ply), etc.).

It is also necessary to take account of the conditions in which the tyre will be used so that its performance meets the user's expectations.

In the event of a change to the original equipment tyre specification, you must ensure that the solution complies with the applicable local legislation (refer to local regulations), its conditions of use and its manufacturer's recommendations. In some countries, a vehicle modified in this way must receive authorisation from the relevant authorities.

MICHELIN tyres are designed for a specific use as defined in this catalogue. Any other use constitutes abnormal use. However, in some circumstances, MICHELIN may issue a waiver which will specify the accepted conditions and exceptional restrictions for use. MICHELIN cannot accept any responsibility for the abnormal use of its tyres or if an express written waiver has not been issued.

Any second-hand or used tyre that has been involved in an accident must, prior to fitting, be checked carefully by a professional to ensure the safety of the user and compliance with the applicable regulations. In addition, some mechanical parts can wear out more quickly if you use tyres incorrectly or choose inappropriately.

TYRE MARKINGS

WHAT DO THE MARKINGS ON A TYRE MEAN?



XeoBib	Range
VF = Very High Flexion	Prefix designating a standardised category of tyres
650	Nominal section width of the tyre in mm
60	Aspect ratio (ratio between sidewall height/nominal tyre section) as a %
R	Structure: «R» for radial «-» for bias
38	Nominal rim diameter in inches
155	Standardized load index (see page 13)
D	Standardized speed rating (see page 13)
Radial	Structure
Tubeless	Tyre with no inner tube
Michelin® X®	Trademark

TYRE DIMENSIONS

SW	Tyre section width
R'	Static Loaded Radius
OD	Overall diameter = 2 R
ø	Rim diameter

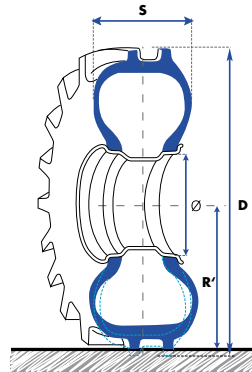

THE 42" SERIES... AND 38" EQUIVALENT

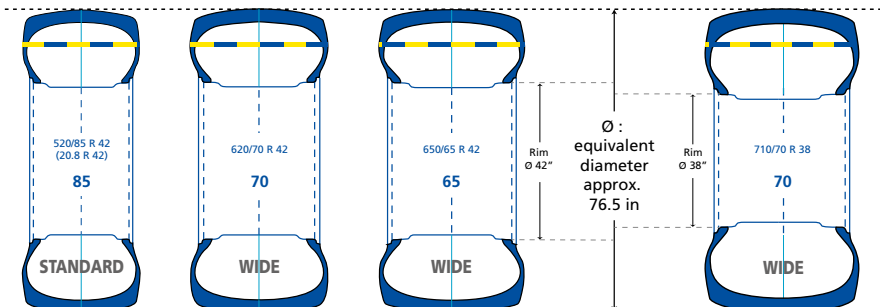

LOAD INDICES AND SPEED RATINGS

All tyres come with operational references comprising the load capacity index (number) and speed rating (letter or letter and number).

The tables below show the tyre load indexes and speed ratings with corresponding values

LOAD INDEXES

Index	Load in kg	Index	Load in kg	Index	Load in kg	Index	Load in kg	Index	Load in kg	Index	Load in kg
101	825	117	1285	133	2060	149	3250	165	5150	181	8250
102	850	118	1320	134	2120	150	3350	166	5300	182	8500
103	875	119	1360	135	2180	151	3450	167	5450	183	8750
104	900	120	1400	136	2240	152	3550	168	5600	184	9000
105	925	121	1450	137	2300	153	3650	169	5800	185	9250
106	950	122	1500	138	2360	154	3750	170	6000	186	9500
107	975	123	1550	139	2430	155	3875	171	6150	187	9750
108	1000	124	1600	140	2500	156	4000	172	6300	188	10000
109	1030	125	1650	141	2575	157	4125	173	6500	189	10300
110	1060	126	1700	142	2650	158	4250	174	6700	190	10600
111	1090	127	1750	143	2725	159	4375	175	6900	191	10900
112	1120	128	1800	144	2800	160	4500	176	7100	192	11200
113	1150	129	1850	145	2900	161	4625	177	7300	193	11500
114	1180	130	1900	146	3000	162	4750	178	7500	194	11800
115	1215	131	1950	147	3075	163	4875	179	7750	195	12150
116	1250	132	2000	148	3150	164	5000	180	8000	196	12500

SPEED RATINGS

Code	Speed in km/h	Speed in mph
A2	10	6
A5	25	15
A6	30	20
A8	40	25
B	50	30
D	65	40
E	75	44
F	80	50
G	90	55
J	100	60

UNITS OF MEASUREMENT

1 centimetre	cm	= 0.3937 inch	1 inch	in	= 2.54 cm
1 metre	m	= 3.281 feet	1 foot	ft	= 0.3048 m
1 kilometre	km	= 0.6214 mile	1 mile	ml	= 1.6093 km
1 litre	l	= 0.2199754 imp. gallons	1 imp. Gallon	imp. gall.	= 4.545963 litres
1 kilogram	kg	= 2.204622 pounds	1 pound	lb	= 0.4535924 kg
1 horsepower	hp	= 735.499 W	1 kilowatt	kw	= 1.3596216173 hp
1 bar	bar	= 14.5037738 psi	1 bar	bar	= 100 kPa (kilopascal)
1 pound per square inch	psi	= 6.89476 kPa	1 imp. acre		= 0.4046842 ha
1 hectare	ha	= 2.4711 imp. acres	1 square inch (imp.)	sq in	= 6.451578 cm ²
1 square centimetre	cm²	= 0.1550 sq.in (imp.)	1 tonne	t	= 0.9842064 tn (imp)
1 ton (imp)	tn	= 1.016047 t	1 kilometre/hour	km/h	= 0.62137 mph
1 mile per hour	mph	= 1.609344 km/h			

OPERATING INSTRUCTIONS

DETERMINING TYRE PRESSURE:

- Tyre pressure is always determined in relation to the load per tyre, the intended speed and the work to be performed.
- The load to be taken into account is the highest one:
 - For tractors:
 - front axle: tractor with its mass / equipment on front in road position and with no load on the rear axle
 - rear axle: tractor with equipment in position for transport.

Note : for a tractor equipped with a front loader, consider with max. load on the loader.

For harvesters or muck spreaders, it is fully loaded (full tank), with the header (or picker).

Note : for harvesters, determine the axle load::

- front axle with cutter bar or picker
- rear axle without the cutter bar or picker

- Determine the pressure for "use in the field" and "use on-road" and select the higher of the two
- For intensive on-road use or on slopes and inclines, follow the instructions given in the pages 'Technical features of MICHELIN tyres'
- For Compact Line vehicles refer to vehicle manufacturers recommendations when setting pressure.

WHEN IN USE

- Distribute the loads evenly
- Adapt your driving to the conditions (load, speed, slope, incline, condition of road or other terrain).

INFORMATION

- Regularly check your tyre pressure
- Periodically check the condition of your tyres and have them checked by a qualified tyre professional

Reminder:

- Damage caused by a puncture or an impact may be not visible initially and may become apparent after some time
- Tyres age even when not in use
- Have any tyres repaired by a qualified professional.

CALCULATION OF MECHANICAL LEAD

For the transmission unit of a 4-wheel drive tractor to operate correctly the correct mechanical lead must be used. This rule does not apply in the case of 4 wheels of the same size.

Most tractor manufacturers impose a mechanical lead of between 0% and 6%. This lead is specific, and may vary depending on the manufacturer and the vehicle.

An inappropriate mechanical lead ratio

- increases fuel consumption,
- results in more rapid front and rear tyre wear,
- results in more rapid wear on the transmission unit,
- results in poor tractor performance when doing some jobs (e.g. ploughing)

and causes

- abrupt front axle engagement and / or disengagement,
- a loss in power and performance,
- deterioration of the top soil.

Note: The front axle must never be engaged on the road!

Calculation of mechanical lead:

$$\frac{(\text{RC}_{\text{FRONT}} \times R) - \text{RC}_{\text{REAR}}}{\text{RC}_{\text{REAR}}} \times 100 = \text{mechanical lead in \%}$$

RC_{REAR}: Rear tyre rolling circumference (specified in the technical documentation)

RC_{FRONT}: Front tyre rolling circumference (specified in the technical documentation)

R: inter-axle ratio (This is fixed initially by the manufacturer)

FRONT WHEEL LEAD % MEASUREMENT



Put marks on the tyres as picture above.

STEP 1 :

FRONT AXLE **NOT ENGAGED** (out of 4WD)

Do 10 turns of rear tyres and count the number **N** of turns for front.

STEP 2 :

FRONT AXLE **ENGAGED** (in 4WD)

Do 10 turns of rear tyres and count the number **N1** of turns for front.

$$\text{Calculation of measurement} = \frac{(N1 - N)}{N} \times 100$$

LOAD-BALANCING CALCULATION

SINGLE FITTING

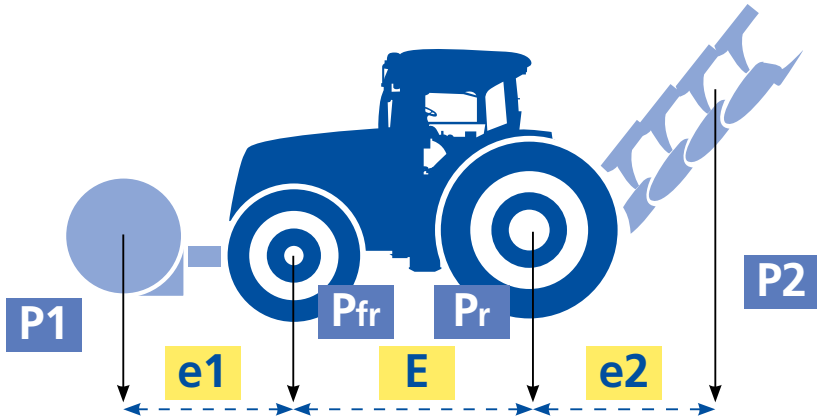

	Front axle (fr)	Rear axle (re)
Tractor (kg)	P fr	P re
Equipment or weights (kg)	P 1	P 2
Calculation for equipment or weights (kg)	$P 1 \times (e1/E)$	$P 2 \times (e2/E)$
Total for axle (kg)	$P fr + P 1 + [P 1 \times (e1/E)]$	$P re + P 2 + [P 2 \times (e2/E)]$
Number of tyres	N fr	N re
Load per tyre (kg)	Total axle fr / N fr	Total axle re / N re

Examples :

Data	Front	Rear
Tractor (kg)	3 000	5 000
Equipment or weights (kg)	1 000	2 000
Distance (metres)	$E = 3 \text{ m} / e1 = 1,5 \text{ m} / e2 = 2,5 \text{ m}$	

Calculations	Front axle (fr)	Rear axle (re)
Tractor (kg)	3 000	5 000
Equipment or weights (kg)	1 000	2 000
Calculation for equipment or weights (kg)	$1\ 000 \times (1,5 / 3) = 500$	$2\ 000 \times (2,5 / 3) = 1\ 666$
Total for axle (kg)	$3\ 000 + 1\ 000 + 500 = 4\ 500$	$5\ 000 + 2\ 000 + 1\ 666 = 8\ 666$
Number of tyres	2	2
Load per tyre (kg)	$4\ 500 / 2 = 2\ 250$	$8\ 666 / 2 = 4\ 333$

LOAD-BALANCING CALCULATION

DUAL *OR TRIPLE* FITTING

- 1 - Divide the axle load by 4 if dual (or by 6 if triple)**
- 2 - Then divide the result by 0.88 if dual (or by 0.82 if triple)**

* For load calculation, see previous page.

Example of a calculation for a dual fitting:

- Tractor with 650/85R38 MICHELIN MACHXBIB 173A8/173B TL
- Established axle load = 14000 kg
- Use = stubble ploughing

a) If the Dual line at the desired speed is in the load/pressure table:

- divide the total load by 4 (4 tyres)
- use the Dual line to determine pressure

b) If the Dual line at the desired speed is not in the load/pressure table:

- divide the total load by 4
- divide the result by 0.88
- use the desired speed line on the load/pressure table

Example for a total load of 14000 kg on a dual fitted rear axle:

$$[30,800 / 4] / 0.88 = 3977 \text{ kg}$$

i.e. recommended pressure of 0.8 bar for a speed of 30 km/h

Note: for triple fitting, divide the load by 6, then divide by 0.82 to obtain the load in question.

RIM AND O-RING REFERENCES

Type of rim	Sizes	Dimension F in mm	Dimension H in mm	Dimension P in mm	
5° standard hollow rim	2.50 C	63,5	16,5	18	
	3.00 D	76	18		
	3.50 D	89			
	4.00 E	101,5	20		
	4.50 E	114,5			
	5.00 E	127	23,5		
	5.375 I	136,5	16		23
	5.50 F	140	22,5		23,5
6.00 F	152,5				
6.50 F	165				
5° conical seat hollow rim	9	228,5	25,5	27	
	11	279,5		31,5	
	12	305			
	13	330			
	14	355,5			
	16	406,4		25,4	
15° conical seat hollow rim	10.50	266,7	12,7	44	
	11.75	298,5			
	12.25	311			
	13.00	330			
	14.00	355,5			
	15.00	381			
	16.00	406,5			
	AG 16.00	406,5			
	17.00	432			
	18.00	457			
	20.00	508			
	AG 20.00	508			
	AG 24.00	609,5			
	AG 28.00	711			
3-PIECE RIM	11	279,5	25,5		
	12	305			
	13	330			
	36.0TH	914,4			38,1
36.00 VA	914,4	43,1			
W rim	W 6	152,4	22,2	23,8	
	W 7	177,8			
	W 8	203,2			
	W 8L	203,2			
	W 9	228,6	25,4	27	
	W 10	254			
	W 10L	254	22,2		
	W 11	279,4			
	W 12	304,8			
	W 13	330,2			
	W 14L	355,6	25,4		
	W 15L	381	33		
	W 16L	406,4			
	W 18L	457,2			

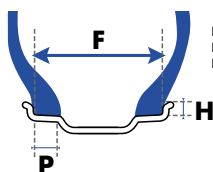

F = interior width
H = Flange height (+/- 1 mm)
P = Seat width

Type of rim	Sizes	Dimension F in mm	Dimension H in mm	Dimension P in mm
DW rim	DW 10	254	25,4	36,5
	DW 11	279,4		
	DW 12	304,8		
	DW 13	330,2		
	DW 14L	355,6		
	DW 15L	381		
	DW 16L	406,4		
	DW 17L	431,8		
	DW 18L	457,2		
	DW 20B	508		
	DW 21B	533,4		
	DW 23B	584,2		
	DW 24B	609,5		
	DW 25B	635		
	DW 27B	686		
	DW 28B	711		
DW 30B	762			
TW rim	TW 13	330	25,5	27
	TW 14L	355,5		36,5
	TW 15L	381		
	TW 16L	406,5		29
	TW 18L	457		
	TW 20B	508		
	TW 21B	533,5		
	TW 23B	584		
	TW 24B	609,5		
	TW 25B	635		
TW 27B	686			
TW 28B	711			
TW 30B	762			
DD rim	DD 16L	406,5	41	50,5
	DD 18L	457		
MW rim	MW 20	508	29	50,8
	MW 23	584		
DH27B rim	MW 25	635	29	54
	DH 27B	686		

DW-B rims are replacing DW-A rims - they are identical and totally interchangeable

If the DW rim is authorised then so is the corresponding TW rim (ETRTO)

O-RINGS FOR 3-PIECE RIMS

Reference	Designation	Note	IAC
R 1681	O-ring OR 6.6 - 20	For 20" rim in 3 pieces	553215
R 1438	O-ring OR 2 - 25	For 25" rim in 3 pieces	553201
R 2052	O-ring OR 2 - 32	For 32" rim in 3 pieces	553055

O-ring designations:

- OR: abbreviation of o-ring
- The first number is the section of the ring joint - a whole number expressing 8ths of an inch (e.g.: 2 = 2/8").
- The second number is the diameter of the seat - a whole number expressed in inches.

INNER TUBE AND VALVE REFERENCES

TYRE & RIM DESCRIPTION		VALVE		KLEBER TUBE		MICHELIN TUBE		PACKAGING
RIM Ø (IN-CHES)	TYRE SIZE	VALVE REF.	VALVE OFFSET	KLEBER REF.	KLEBER CAI	MICHELIN REF.	MICHELIN CAI	
6	3.50 - 4.00	10SC29	0	826	158611			8
8	4.00	10SCH40	0	360	125528			8
12	4.00	TR13	13			12C13	125674	40
	7.00	TR15	25	389	101397			4
15	4.00	TR13	15			15CB13	125682	40
	5.00 - 6.70	TR13	22			15F13	125622	24
15.3	10.0/75 - 11.5/80 - 12.5/80	TR15	80	463	170029			4
16	4.50	TR218A	19	420	101467	M420	834861	4
	5.50 - 6.00	TR15	60	182	170010	M182	884753	4
	6.00 - 6.50	TR218A	60	313	039318	M313	183634	1
	6.50 - 7.00	TR15	65	311	170014			4
	7.50	TR218A	70	431	170000	M431	509471	1
	7.50	TR13	25			16J13	125639	16
	7.50	TR15	70	317	170016	16J15	125669	16
	10.00 - 11.00	TR218A	90	485	170030	M485	410859	1
	11LR - 280/70	TR218A	65	184	171108	M184	764859	1
	10.50 - 270/65 - 275/65 - 320/65	TR218A	65	827	813635	M827	030552	1
16.5	260/70 - 300/70	TR218A	65	184	171108	M184	764859	1
18	7.50	TR218A	70	440	170001	M440	594387	1
	7.50	TR15	70	441	170023			4
	10.5/80 - 280/80 - 260/70 - 280/70 - 270/65	TR218A	70	438	171109	M438	582674	1
	12.0 - 12.5 - 335/80 - 340/80 - 320/65 - 340/65	TR218A	90	444	170025	M444	756917	1
	12.0 - 12.5 - 335/80 - 340/80 - 13.0/65 - 320/65 - 335/65 - 340/65	TR15	80	828	057866	M828	126008	1
19	4.00 - 4.50	TR13	15	446	101417			4
	6.00	TR13	50	449	320346			1
	6.00	TR15	50	452	170026			1
19.5	445/70 (18 R 19.5)	DR1964				19.5/20.5 UD	101280	3

INNER TUBE AND VALVE REFERENCES

TYRE & RIM DESCRIPTION		VALVE		KLEBER TUBE		MICHELIN TUBE		PACKAGING
RIM Ø (INCHES)	TYRE SIZE	VALVE REF.	VALVE OFFSET	KLEBER REF.	KLEBER CAI	MICHELIN REF.	MICHELIN CAI	
20	7.50	TR218A	65	655	170004	M655	575125	1
	7.50	TR15	60	660	170033			4
	9.5 - 260/70 - 280/70	TR218A	65	533	171110	M533	504653	1
	10.00 (Flap)					20x7.50 E	320222	5
	10.00 (Tube)	582				20N	101162	7
	10.5 - 11.2 - 280/80 - 300/70 - 320/70	TR218A	90	542	171111			1
	12.4 - 320/85 - 12.5/80 - 335/80 - 340/80 - 340/75	TR218A	90	444	170025	M444	756917	1
	12.5 - 14.5 - 14.9 - 335/80 - 340/80 - 340/75 - 375/75 - 380/75 - 420/75 - 425/75 - 360/70 - 400/70 - 405/70 - 420/65 - 440/65	TR218A	90	664	171112	M664	657648	1
	For 375/75 and 405/70 R 20 on flat rim	750				20RD	101394	5
	For 425/75 R 20 on flat rim	576				20V	511937	1
For 20" rims in 3 pieces	O-Ring 1681				OR 6.6 - 20	553215	20	
20.5	20.5 - 525/65	DR1964	75			19.5/20.5 UD	101280	3
	24	SC1837	100			20.5W AMD	101331	1
22.5	600/55	TR218A	90	716	170047	M716	346313	1
24	8.3 - 9.5 - 250/85	TR218A	70	686	170035	M686	820931	1
	11.2 - 12.4 - 280/85 - 320/85 - 320/70 - 360/70	TR218A	85	692	170037	M692	970338	1
	13.6 - 14.5 - 340/85 - 380/70 - 420/65	TR218A	85	700	170039	M700	519392	1
	14.9 - 380/85 - 400/80 - 400/70 - 420/70 - 440/65	TR218A	127	703	171114	M703	027015	1
	16.9 - 17.5LR - 19.5LR - 420/85 - 440/80 - 440/70 - 445/70 - 460/70 - 480/70 - 495/70 - 500/70 - 540/70 - 480/65 - 540/65	TR218A	100	710	170042	M710	460503	1
25	1000/50 - For 25" rims in 3 pieces	O-Ring R 1438				OR 2-25 HEUPO	553201	20
26	18.4 - 480/80 - VF520/80 - 480/70 - 520/70 - 580/70 - VF620/70	TR218A	90	716	170047	M716	346313	1
	23.1 - 620/75 - 580/70 - 620/70	TR218A	110	830	823746	M830	036738	1
	620/70	TR218A	110	717	101447	M717	438361	1
	750/65	TR218A	160	833	975074			1
26.5	600/55	TR218A	90	716	170047	M716	346313	1

INNER TUBE AND VALVE REFERENCES

TYRE & RIM DESCRIPTION		VALVE		KLEBER TUBE		MICHELIN TUBE		PACKAGING
RIM Ø (IN-CHES)	TYRE SIZE	VALVE REF.	VALVE OFFSET	KLEBER REF.	KLEBER CAI	MICHELIN REF.	MICHELIN CAI	
28	9.5 - 11.2 - 280/85	TR218A	65	725	170050	M725	330841	1
	12.4 - 320/85 - 360/70	TR218A	85	726	170051	M726	316215	1
	13.6 - 340/85 - 380/70 - 420/65	TR218A	85	732	170053	M732	049533	1
	14.9 - 380/85 - 420/70 - 440/65 - VF480/60	TR218A	85	821	170148	M821	483956	1
	16.9 - 19.5LR - 420/85 - 440/80 - 480/70 - 480/65 - 540/65 - VF520/60 - VF600/60	TR218A	120	822	170149	M822	428511	1
	600/70 - 600/65	TR218A	110	717	101447	M717	438361	1
30	14.9 - 380/85 - 420/70	TR218A	90	734	170054	M734	626564	1
	16.9 - 420/90 - 420/85 - 420/80 - 480/70 - 540/65 - VF540/65	TR218A	95	754	170058	M754	743325	1
	18.4 - 460/85 - 520/70 - VF600/60	TR218A	95	757	170060	M757	579464	1
	23.1 - 520/85 - 620/75 - IF620/75 - VF620/75 - 600/70 - IF600/70 - VF620/70	TR218A	92	737	192251	M737	589735	1
32	8.3 - 9.5 - 210/95 - 230/95	TR218A	70	758	013109			1
	11.2 - 270/95	TR218A	70	763	983325			1
	12.4 - 320/85	TR218A	90	760	877890			1
	24.5 - 30.5 - 680/85 - IF680/85 - 650/75 - 680/75 - 800/70 - IF800/70 - 800/65 - IF800/65 - 900/60 - IF900/60	TR218A	170	831	664520	M831	289134	1
	1000/55 For 32" rims in 3 pieces	O-Ring R 2052				OR 2-32	553055	20
34	16.9 - 380/85 - VF380/85 - 420/85 - VF420/85 - 480/70 - IF480/70 - 540/65	TR218A	95	704	171115	M704	862196	1
	18.4 - 460/85 - 500/70 - 520/70 - 540/70 - 600/65 - IF650/65 - VF600/60 - IF650/60	TR218A	100	823	170150	M823	164970	1
	24.5 - 710/75	TR218A	180	765	101429			1
36	9.5 - 11.2 - 12.4 - 230/95 - 270/95 - 320/85	TR218A	65	779	170072	M779	404542	1
	13.6 - 340/85	TR218A	80	780	170073			1



INNER TUBE AND VALVE REFERENCES

TYRE & RIM DESCRIPTION		VALVE		KLEBER TUBE		MICHELIN TUBE		PACKAGING
RIM Ø (INCHES)	TYRE SIZE	VALVE REF.	VALVE OFFSET	KLEBER REF.	KLEBER CAI	MICHELIN REF.	MICHELIN CAI	
38	11.2 - 12.4 - 270/95 - 320/85	TR218A	65	779	170072	M779	404542	1
	13.6 - 380/95 - VF380/95 - 340/85 - 380/80 - VF380/80	TR218A	90	795	170079	M795	456392	1
	14.9 - 16.9 - 380/85 - 420/85 - 480/70	TR218A	95	786	170076	M786	325321	1
	15.5 - 380/95 - VF380/95 - 380/80 - VF380/80 - 400/75	TR218A	90	796	118826	M796	044169	1
	18.4 - 460/85 - 520/70 - 540/65 - VF600/60	TR218A	100	824	170151	M824	156066	1
	20.8 - 520/85 - 580/70 - 620/70 - 600/65 - 650/65 - IF650/65 - VF650/60 - IF710/60 - VF710/60	TR218A	105	825	170152	M825	701676	1
	650/85 - IF650/85 - IF710/85 - 650/75 - IF650/75 - IF680/75 - 710/70 - IF800/70	TR218A	105	804	170088	M804	004503	1
42	16.9 - 18.4 - 480/80	TR218A	90	801	170084	M801	333630	1
	20.8 - 520/85 - VF520/85 - 580/85 - VF650/85 - IF710/75 - 620/70 - 710/70 - IF710/70 - 650/65 - VF650/65 - VF710/60	TR218A	140	802	170006	M802	158373	1
44	11.2 - 270/95	TR218A	80	813	440524			1
46	12.4 - 14.9 - 300/95 - 420/85 - 380/80 - VF380/80 - 420/80	TR218A	80	835	203376	M835	847882	1
	18.4 - 20.8 - 520/85 - 480/80 - VF480/80	TR218A	100	834	467962	M834	072291	1
48	9.5 - 11.2 - 230/95 - 270/95	TR218A	80	835	203376	M835	847882	1
50	320/90	TR218A	70	816	170007	M816	762800	1
52	12.4 - 300/95	TR218A	70	816	170007	M816	762800	1
54	11.2 - 270/95 - 320/90	TR218A	70	816	170007	M816	762800	1

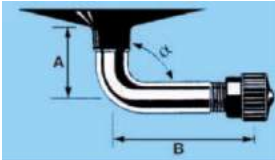
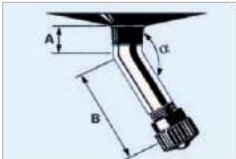
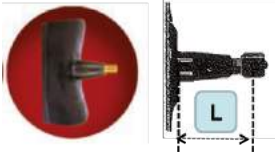
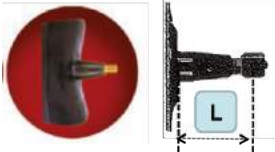
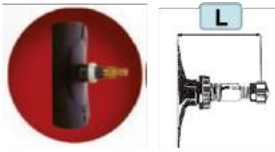
VALVE CHARACTERISTICS

Sizes	Type of rim	Dimension F in mm
INNER TUBE VALVES		
10 SC29		A = 15 mm B = 29 mm $\alpha = 90^\circ$ \varnothing = valve hole = 10 mm
10 SCH40		A = 13 mm B = 27 mm $\alpha = 150^\circ$ \varnothing = valve hole = 10,2 mm
TR13 (ETRTO = V2-01-1)		L = 35 mm \varnothing = valve hole = 11,5 mm
TR15 (ETRTO = V2-01-2)		L = 35 mm \varnothing = valve hole = 16 mm
TR218A (ETRTO = V7-01-1) Air/water valve		L = 47,5 mm \varnothing = valve hole = 15,7 mm

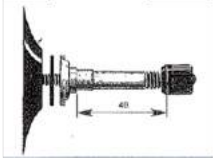
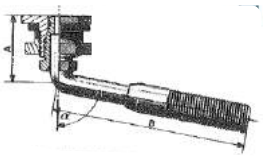
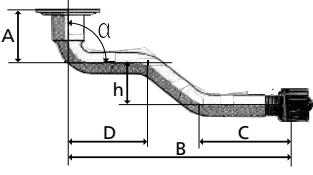
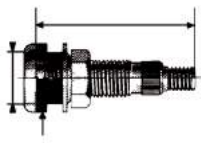
VALVE CHARACTERISTICS

Sizes	Type of rim	Dimension F in mm
INNER TUBE VALVES		
1964		L = 40 mm Ø = valve hole = 9,7 mm
1837 Equivalence : • TRA = TRJ650 • ETRTO = V5-04-1		A = 27 mm B = 79 mm $\alpha = 80^\circ$ Ø = valve hole = 20,5 mm
582 (ETRTO = V3.06.5)		A = 20,5 mm / B = 131 mm C = 49 mm / D = 62,5 mm $\alpha = 90^\circ$ / h = 17 mm
1123 (ETRTO = V3.06.8)		A = 24,5 mm / B = 126,5 mm C = 50,5 mm / D = 61,5 mm $\alpha = 94^\circ$ / h = 17 mm
TUBELESS VALVES		
TR618A (ETRO = V5-01-1) Air/water valve		L = 47,5 mm Ø = valve hole = 15,7 mm
AIR / WATER VALVE TIP		
		

INSTRUCTIONS FOR REMOVING / FITTING TYRES

Fitting and removal operations can involve risks and must be carried out by a trained and qualified professional using the appropriate tools and operating methods.

Never entrust these operations to an apprentice working alone; if these operations are carried out by more than one person in the case of fitting large volume tyres, make sure that at least one person is present throughout the operation.

Use a compressed air supply equipped with a pressure regulator.

Not following these instructions and methods may result in the tyre being incorrectly fitted to the rim and cause rapid tyre deflations with the associated risk of serious injury or even a fatality.

REMOVING A TYRE FROM THE RIM

1. **Never try to remove the beads of an inflated tyre from a rim**
2. **Valve core must be removed.**
 - make sure that the tyre is fully deflated before starting removal,
 - do not use tools that may damage the sidewalls or the beads
 - if the tyre is equipped with removal notches detach the beads from them,
 - to aid removal and protect the beads, particularly in case of a puncture, lubricate the rim seats and the tyre beads,
 - if the rim shows obvious damage, then it must be deflated before the assembly is removed.

PREPARATION FOR FITTING

1. **Before fitting, ensure that the rim, tyre and inner tube are compatible, and check that:**
 - the tyre is suitable for the vehicle or machine,
 - the diameter of the rim seat corresponds to the seat of the tyre to be fitted
eg. 18.4 R30 tyre and DW 16 x 30 rim
 - the tyre may be fitted to this rim (see characteristics in the Manufacturer's Documentation).

⚠ Remember - There are rims with seat diameters of 15.3"; never fit these rims with 15" tyres. The same thing applies for 16.1" and 15.5" rims; never fit 16" tyres.

2. **Before fitting a tyre to a rim that has already been used:**
 - the rim must be clean and in perfect condition (showing no damage),
 - if not, then thoroughly clean the rim using a metal brush. Never fit a tyre to a rim that has splits, is badly misshapen, has cracks, traces of repairs by welding...

INSTRUCTIONS FOR REMOVING / FITTING TYRES

3. If the tyre has been used, carefully examine its interior and exterior for possible damage.
 - if it shows signs of damage or deterioration that are deemed irreparable by a specialist, discard the tyre.
4. For inner tube fittings, always use a new inner tube suitable for the tyre dimensions (inner tube markings showing compatible tyre sizes).

⚠ Do not fit the inner tube to a damaged or repaired rim, or to a rim with a finish incompatible with a tube.

Fit a new Tubeless valve whenever you replace a Tubeless tyre.

5. Always use tools that have no sharp edges, are in good condition and are suitable for the tyres and rims (bead unseating, levers, machines...).

For wide or large tyres, we recommend using a bead pusher or bead unseating tool (with appropriate mechanical assistance) to fit the second bead use the bead pusher to ensure the second bead is in the base of the well of the rim to prevent tyre damage.

Before fitting, lubricate the rim seats and tyre beads. Apply a thin layer of lubricant to the surfaces shown on the diagram below; on the outside of the beads the lubricant should reach 5 cm above the rim flange.

Only use products designed for this purpose that will not degrade the tyre (do not for example use hydrocarbon, silicon or antifreeze-based products).

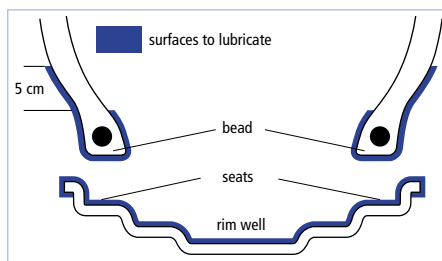

INSTRUCTIONS FOR REMOVING / FITTING TYRES

VERTICAL FITTING OF TYRE TO WHEEL

1. Position the valve or valve hole at the bottom.
2. If there is a diagram of the valve on the sidewall of the tyre, position the diagram as close as possible to the rim valve hole or valve.
3. Slip the tyre onto the rim so that the first tyre bead is positioned against the rim flange. Remember to rotate in the direction indicated by the arrow on the tyre (if present).
4. Using a suitable lever to apply pressure approximately every 10 cm:
 - push the first bead over the rim flange.

Once the first bead is over:

- position the lightly inflated inner tube inside the tyre (for inner tube fittings),
- fix the valve by partially tightening the nut.

For the second bead:

- lever it over the rim flange,
- finishing at the valve.

5. Centring the tyre, fitting the beads

- lower the jack slightly to optimise tyre centring,
- pull out the valve's inner mechanism,
- slowly and partially inflate for optimal bead positioning,
- check the beads are not pinching the inner tube,
- inflate to 2.5 bar but no more, to ensure that the beads are properly positioned.

INFLATION AND BEAD POSITIONING

Apply safety rules:

- system to support the tyre assembly (safety cage),
- safety goggles,
- safety footwear,
- ear defenders.

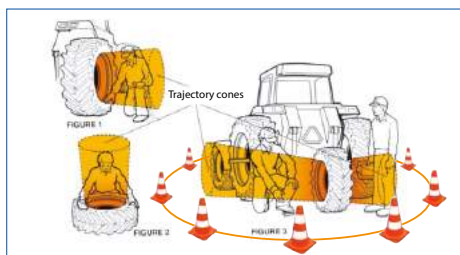

If there is no safety bar or cage, the operator should be as far as possible from the tyre and the rim.

⚠ Never stand within the trajectories cones (Figures 1, 2 and 3), to avoid any risk of physical injury in the event of an incident.

For optimum safety conditions use a fully functional inflation gun connected to the valve by an air-hose extension of at least 3 meters, with a clip fitting to the valve and a calibrated pressure-gauge (never lock the trigger).

When positioning the beads take particular care to ensure they are correctly located and centred in relation to the rim flanges and inflate to 2.5 bar, but no more.

INSTRUCTIONS FOR REMOVING / FITTING TYRES

If the beads are not correctly positioned:

- deflate, re-lubricate and inflate to 2.5 bar
- repeat the operation as often as necessary until the beads are correctly positioned.

To fit and position the beads to the rim seats
INFLATE TO 2.5 BAR WITHOUT EXCEEDING THIS PRESSURE

The pictogram opposite shows the maximum inflation pressure which must not be exceeded when positioning the beads.

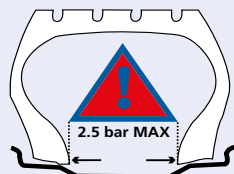

Once all the preceding operations have been properly executed,

- replace the valve's inner mechanism,
- tighten the nut on the valve by hand,
- inflate to the determined service pressure, according to the load levels stated in the manufacturer's documentation, or to storage pressure,
- tighten the valve cap after any inflation or pressure check, as this alone ensures that the valve remains clean and sealed.

If fitting the tyre horizontally on the ground (not recommended because it is impossible to see if the lower bead is in place), take the following additional precautions:

- Initially, do not go above a maximum pressure of 0.7 bar (to establish the seal),
- Lift the tyre-rim assembly, place it in a safety cage or position the upper part against a wall, never against a door or light partition wall,
- Follow the instructions for inflation and positioning the beads.

Note:

All radial tyres to be used at low pressures must be fitted to high quality rims.

BEGINNING OPERATIONS / RECOMMENDATIONS

- When transporting machinery (by road, rail or ship), we recommend inflating tyres to 1.8 bar (26 psi) to avoid damage due to certain stowage systems.
- When starting the machinery, pressures must be determined and adjusted according to the load on the tyres and actual conditions of use.

USER INSTRUCTIONS

Correct pressure

=

- ✓ Comfort
- ✓ Grip
- ✓ Soil protection
- ✓ Type service life
- ✓ Optimal machine productivity

INSTRUCTIONS FOR REMOVING / FITTING TYRES

BALLASTING

• **Ballasting tyres with liquids**

In specific cases, to increase adhesion weight or lower the machine's centre of gravity, both Tubeless and Tube Type tyres can be ballasted with liquid.

Agricultural valves are "air and water". This means tyres can be filled with liquid (water + anti-freeze) to a 75% maximum (diagram 1).

In winter, temperatures may fall below freezing and at 0°C the use of a Glycol based anti-freeze product is required. *As MICHELIN is not involved in the design of those products, MICHELIN's warranty specifically states that MICHELIN will not be held responsible for any associated damages to the tyres.*

Fill the inner tube or Tubeless tyre with liquid up to the level of the valve (valve at highest point), while releasing the air (diagram 2).

Inflation and pressure are adjusted using air.

As the volume of air providing pressure is low (around 25% volume), regular pressure checks are essential - we recommend monthly.

• **Tubeless liquid ballasting**

- Assemble and position the tyre; see "Inflation and bead positioning",
- Deflate the tyre to a low pressure (roughly 0.5 bar)
- Position the valve at the highest point,
- Start to fill the tyre with liquid (water + anti-freeze), to a maximum of 75% while releasing the air (diagram 2),
- Finish inflating with air and adjust the pressure.

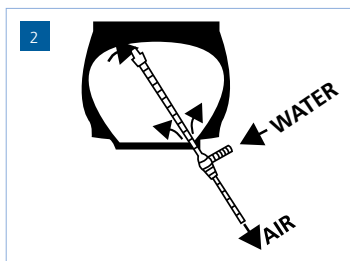
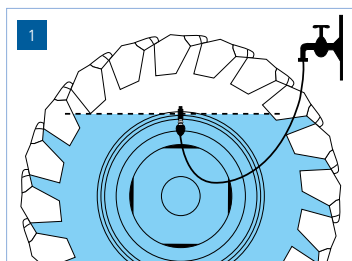

INSTRUCTIONS FOR REMOVING / FITTING TYRES

■ STORAGE

To be correctly stored, tyres must be kept in clean conditions in dry and ventilated premises, away from direct sunlight. They must be kept away from:

- any source of ozone (electric motor, transformer, arc welding station etc..).
- any chemicals, solvents and hydrocarbons that may affect the nature of the rubber.
- any objects that could pierce the rubber (sharp or pointed metal objects etc.).

Keep away from flames or hot objects.

During storage periods, agricultural tyres and inner tubes must be stored to avoid damage due to tension or compression, and so assembled and inflated if stacked; de-ballast vehicle-mounted tyres as much as possible and over-inflate by 0.5 bar in relation to in-use pressures.

 **Never store bare tyres or whole off-vehicle wheels in direct contact with the ground for long periods.**

The use of protective gloves is recommended when handling tyres.

 Never heat, weld or solder a rim or wheel with a tyre fitted.
Always remove the tyre from the rim before any intervention.

 Always use the Michelin inflation table to decide on the correct pressure for the intended use

 Under-inflation causes the carcass to become excessively misshapen and renders the tyre unusable.

 Over-inflation reduces the surface area in contact with the ground, causing a loss of grip and making the tyre more sensitive to impacts and cuts.

 If loads are lower than those shown in our load pressure tables, never go below the minimum tyre pressure shown.

NOTES

A series of horizontal dotted lines for taking notes.



USING AGRICULTURAL TYRES | 2019



Video tutorial :
Fitting and removing a tyre



<https://www.youtube.com/watch?v=cdnfh0o9Yhl>

AGRICULTURAL.MICHELIN.CO.UK



MICHELIN

NOTES

A series of horizontal dotted lines for taking notes.

NOTES

A large section of the page is reserved for notes, consisting of approximately 30 horizontal dotted lines spaced evenly down the page.

MICHELIN AGRICULTURE

TYRES TECHNICAL DATA BOOK | 2019

MICHELIN Tyre PLC,
Agriculture Dept,
South Court, Campbell Road,
Stoke-on-Trent ST4 4EY

Copyright © 2019 Michelin UK, Inc. All rights reserved.

 AGRICULTURAL.MICHELIN.CO.UK

 [@MICHELINAGRIUK](https://twitter.com/MICHELINAGRIUK)

 [MICHELIN AGRICULTURE](https://www.youtube.com/MICHELIN AGRICULTURE)



MICHELIN