

MICHELIN® AGRICULTURE AND COMPACT EQUIPMENT TIRES

TECHNICAL DATA BOOK | 2023



🌐 US: business.michelinman.com/agriculture
🌐 CA: business.michelin.ca
📺 Michelin Agriculture



CONTENTS



TRACTOR TIRES	2-67
AGRIBIB®	2
AGRIBIB® 2	12
YELDBIB™	21
MACHXBIB®	25
AXIOBIB®	32
AXIOBIB® 2	37
MULTIBIB™ / MULTIBIB™ PLUS	43
OMNIBIB™	51
XEOBIB®	57
ROADBIB®	61



HARVESTER & FLOATER TIRES	65-86
CEREXBIB™ 2	65
CEREXBIB™	70
FLOATXBIB	75
MEGAXBIB® 2	78
MEGAXBIB®	82



SPRAYER & ROW CROP TIRES	87-97
SPRAYBIB™	87
AGRIBIB® ROW CROP	94



TRAILERS & IMPLEMENTS	98-113
TRAILXBIB®	98
CARGOXBIB® HIGH FLOTATION	103
CARGOXBIB® HEAVY DUTY	107
CARGOXBIB®	109
XP27™	112



COMPACT EQUIPMENT TIRES 114-159

<i>XMCL™</i>	121
<i>XM27™</i>	124
<i>BIBLOAD® HARD SURFACE</i>	136
<i>CROSSGRIP®</i>	129
<i>XF™</i>	135
<i>XM47™</i>	137
<i>POWER CL™</i>	140
<i>POWER DIGGER</i>	145
<i>BIBSTEEL™ ALL TERRAIN</i>	147
<i>BIBSTEEL™ HARD SURFACE</i>	149
<i>X® TWEEL® SSL 2</i>	151
<i>X® TWEEL® TURF</i>	153
<i>X® TWEEL® TURF CASTER</i>	154
<i>X® TWEEL® UTV</i>	155
<i>X® TWEEL® TURF – GOLF CART</i>	157



OPERATIONAL INFORMATION 158-177

<i>SIZE EQUIVALENCY CHART</i>	159
<i>ROLLING CIRCUMFERENCE INDEX AND SPEED RADIUS INDEX CHART</i>	160
<i>TIRE SIDEWALL MARKINGS</i>	164
<i>LOAD INDICES AND SPEED RATINGS</i>	165
<i>OPERATING INSTRUCTIONS</i>	166
<i>CALCULATION OF MECHANICAL LEAD (4WD)</i>	167
<i>LOAD-BALANCING CALCULATION</i>	168
<i>RIM AND O-RING REFERENCES</i>	170
<i>VALVE CHARACTERISTICS</i>	171
<i>MICHELIN® TUBES</i>	173
<i>MOUNTING / DISMOUNTING</i>	175

READING THE TECHNICAL DATA CHARTS

Specific markings for high technology tires

- **IF: Increased Flexion**
(Tires designed to carry 20% more load at the same pressure or 20% less pressure for the same load compared to standard radials in the same size)
- **VF: Very High Flexion**
(Tires designed to carry 40% more load at the same pressure or 40% less pressure for the same load compared to standard radials in the same size)
- **CFO & CFO+: Improved Flexion Cyclic Field Operation**
(Cyclic Field Operating parameters for IF and VF designated tires)

Rim diameter in inches

(TL)
Tubeless

Local country & international product code

Rim Size (inch)	Description	MSPN (CAI)
38	IF 710/85 R38 178D TL	99013 (992951)

Section Width	Overall Diam. (in.)	Loaded Radius (in.)	Rolling Circum. (in.)	Recommended Rim	Acceptable Rims	Min. Dual / Triple Spacing (in.)	75% internal volume (gal.)	Tread depth (32nd in.)
28.9	85	36.9	250.6	DW25B (A)	MW25B (A)	36.1	287.4	82

Section width in inches

Overall diameter in inches

Loaded radius in inches

Rolling circumference in inches

Preferred rim

Other acceptable rims

Minimum spacing for dual and triple applications

Maximum ballasting volume (gal)

Centerline tread depth

Pressure scale in psi

Psi	6	9	12	15	17	20	23	25	26	28	29	30	32	33	35
40 mph			10750	12160	13560	15045	16535								
40 mph Dual	6700	8080	9460	10690	11925	13240	14550								

Usage speed in mph

Load per tire in lbs



Important notes for tire use appear at the end of technical data pages for each range.



AGRIBIB®

**ALL AROUND PERFORMING
RADIAL WITH LONG SERVICE LIFE**

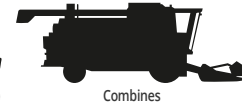

LONG SERVICE LIFE

- Deep lugs, low slip and optimized rubber compounds help reduce wear for exceptionally long tire life
- Proven radial casing endurance
- Damage-resistant rubber fights stubble damage



OPTIMIZED TREAD DESIGN

- Super flat tread and large footprint helps reduce soil compaction
- Strong but flexible casing delivers exceptional ride and comfort



EXCEPTIONAL YEAR-ROUND TRACTION

- Strong flexible sidewalls deliver long footprint with more lugs on the soil
- 45 degree lug angle for better transfer of tractive force to the ground
- “Self cleaning hinge” between lugs keeps tread mud free for optimized pulling power
- Sharp vertical lug design provides traction even when worn; +22% more traction when 60% worn¹

(1) Analytic test on MICHELIN test tracks Ladoux Centre – Size 18.4 R38

SIZES

9.5 R24 112A8/109B TL	16.9 R28 141A8/138B TL	12.4 R36 124A8/121B TL	520/85 R42 157A8/157B TL
11.2 R24 119A8/116B TL	16.9 R30 137A8/134B TL	12.4 R38 131A8/128B TL	420/80 R46 151A8/148B TL
12.4 R24 119A8/116B TL	18.4 R30 142A8/139B TL	13.6 R38 128A8/125B TL	480/80 R46 158A8/158B TL
13.6 R24 124A8/121B TL	380/85 R30 135A8/135B TL	18.4 R38 151A8/148B TL	520/85 R46 158A8/155B TL
14.9 R24 130A8/127B TL	420/90 R30 147A8/147B TL	20.8 R38 159A8/156B TL	480/80 R50 159A8/159B TL
16.9 R24 134A8/131B TL	18.4 R34 149A8/146B TL	380/95 R38 147A8/147B TL	480/95 R50 164A8/164B TL
12.4 R28 126A8/123B TL	320/85 R34 133A8/130B TL	420/85 R38 144A8/144B TL	
13.6 R28 123A8/120B TL	380/85 R34 137A8/137B TL	520/85 R38 155A8/155B TL	
14.9 R28 134A8/131B TL	420/85 R34 147A8/147B TL	480/80 R42 156A8/156B TL	

Tire specifications and pressure table. Load per tire in lbs.*

Rim Size (inch)		Description										MSPN (CAI)			
24		9.5 R24 112A8/109B TL										07126 (200987)			
Section Width	Overall Diam. (in.)	Loaded Radius (in.)	Rolling Circum. (in.)	Recommended Rim	Acceptable Rims						Min. Dual / Triple Spacing (in.)	75% internal volume (gal.)	Tread depth (32nd in.)		
10	41.1	18.9	122.7	W8	W7						13.4	17	40		
Psi	6	7	9	12	15	17	20	23	26	29	30	33	35	38	41
6 mph **	1490	1640	1795	2115	2425	2735	2820	2900	3075	3250	3340	3515	3605		
20 mph	1180	1335	1490	1640	1795	1950	2125	2305	2435	2580	2645				
25 mph			1390	1530	1675	1820	1985	2150	2280	2405	2470				
30 mph			1270	1410	1565	1710	1830	1950	2070	2195	2250				
25 mph Dual	850	1035	1225	1355	1490	1630	1765	1895	2005	2115	2170				

Rim Size (inch)		Description										MSPN (CAI)			
24		11.2 R24 119A8/116B TL [Discontinued December 2022]										92311 (317247)			
Section Width	Overall Diam. (in.)	Loaded Radius (in.)	Rolling Circum. (in.)	Recommended Rim	Acceptable Rims						Min. Dual / Triple Spacing (in.)	75% internal volume (gal.)	Tread depth (32nd in.)		
11.3	43.1	19.8	128.7	W10	W9						15.4	24.4	47		
Psi	6	7	9	12	15	17	20	23	26	29	30	33	35	38	41
6 mph **	1850	2040	2215	2580	2945	3305	3460	3605	3790	3990	4080	4265	4365		
20 mph	1455	1640	1830	2005	2185	2360	2580	2790	2955	3120	3210				
25 mph			1710	1875	2040	2205	2405	2600	2755	2920	3000				
30 mph			1555	1720	1895	2060	2215	2370	2515	2655	2735				
25 mph Dual	1060	1280	1500	1655	1820	1975	2140	2295	2425	2570	2635				

Rim Size (inch)		Description										MSPN (CAI)			
24		12.4 R24 119A8/116B TL [Discontinued December 2022]										78449 (123788)			
Section Width	Overall Diam. (in.)	Loaded Radius (in.)	Rolling Circum. (in.)	Recommended Rim	Acceptable Rims						Min. Dual / Triple Spacing (in.)	75% internal volume (gal.)	Tread depth (32nd in.)		
12.8	45.2	20.5	134.6	W11	W10						16.9	30.5	52		
Psi	6	7	9	12	15	17	20	23	26	28	30	33	35	38	41
6 mph **		2295	2645	2930	3220	3505	3780	4070	4355	4500					
20 mph		1785	2095	2315	2545	2765	3000	3220							
25 mph			1940	2150	2360	2580	2790	3000							
30 mph			1830	2015	2205	2380	2570	2755							

Rim Size (inch)		Description										MSPN (CAI)			
24		13.6 R24 124A8/121B TL [Discontinued August 2022]										06947 (262831)			
Section Width	Overall Diam. (in.)	Loaded Radius (in.)	Rolling Circum. (in.)	Recommended Rim	Acceptable Rims						Min. Dual / Triple Spacing (in.)	75% internal volume (gal.)	Tread depth (32nd in.)		
14.6	47.2	21.7	141.1	W12	W11						18.3	38	54		
Psi	6	7	9	12	15	17	20	23	26	29	30	33	35	38	41
6 mph **	2150	2370	2590	3030	3460	3900	4080	4255	4475	4695	4795	5015	5125		
20 mph	1675	1905	2125	2350	2570	2790	3055	3305	3495	3680	3770				
25 mph			1985	2195	2390	2600	2845	3085	3265	3440	3525				
30 mph			1810	2015	2225	2435	2625	2810	2965	3130	3210				
25 mph Dual	1225	1490	1740	1940	2125	2325	2515	2710	2865	3030	3110				
25 mph FRT								3415	3705	3915	4025	4235	4320	4495	

* Refer to the notes at the end of the tables of this range

Tire specifications and pressure table. Load per tire in lbs.*

Rim Size (inch)		Description										MSPN (CAI)			
24		14.9 R24 130A8/127B TL [Discontinued August 2022]										92158 (601563)			
Section Width	Overall Diam. (in.)	Loaded Radius (in.)	Rolling Circum. (in.)	Recommended Rim	Acceptable Rims					Min. Dual / Triple Spacing (in.)	75% internal volume (gal.)	Tread depth (32nd in.)			
15.6	49.8	22.6	148.4	W13	W11 W12					19.8	49.5	60			
Psi	6	7	9	12	15	17	20	23	26	29	30	33	35	38	41
6 mph **	2570	2820	3085	3605	4110	4630	4795	4960	5245	5545	5690	5975	6120		
20 mph	2005	2295	2570	2810	3065	3305	3605	3890	4135	4365					
25 mph			2405	2635	2855	3085	3360	3640	3860	4080					
30 mph			2185	2425	2670	2910	3110	3305	3505	3715					
25 mph Dual	1455	1785	2115	2335	2545	2765	2975	3195	3395	3585					

Rim Size (inch)		Description										MSPN (CAI)			
24		16.9 R24 134A8/131B TL [Discontinued December 2022]										97341 (123854)			
Section Width	Overall Diam. (in.)	Loaded Radius (in.)	Rolling Circum. (in.)	Recommended Rim	Acceptable Rims					Min. Dual / Triple Spacing (in.)	75% internal volume (gal.)	Tread depth (32nd in.)			
18.1	52.4	23.1	154.9	DW15L	DW14L W14L W15L					22.3	64.4	69			
Psi	6	7	9	12	15	17	20	23	26	29	30	33	35	38	41
6 mph **			3570	4145	4585	5025	5465	5910	6350	6790					
20 mph			2800	3240	3595	3945	4300	4650							
25 mph			3040	3375	3695	4025	4345								
30 mph			2845	3130	3430	3715	4010								
25 mph Dual	1740	2215	2680	2965	3250	3540	3825	4110							

Rim Size (inch)		Description										MSPN (CAI)			
28		12.4 R28 126A8/123B TL										20895 (738964)			
Section Width	Overall Diam. (in.)	Loaded Radius (in.)	Rolling Circum. (in.)	Recommended Rim	Acceptable Rims					Min. Dual / Triple Spacing (in.)	75% internal volume (gal.)	Tread depth (32nd in.)			
12.7	49.8	23.1	148.7	W11	W10					16.9	35.5	50			
Psi	6	7	9	12	15	17	20	23	26	29	30	33	35	38	41
6 mph **	2280	2515	2745	3210	3670	4135	4320	4495	4740	4980	5095	5335	5455		
20 mph	1775	2040	2305	2525	2735	2955	3250	3540	3725	3915					
25 mph			2150	2350	2555	2755	3030	3305	3485	3660					
30 mph			1950	2160	2370	2580	2800	3010	3165	3330					
25 mph Dual	1300	1600	1895	2095	2305	2500	2710	2910	3065	3220					

Rim Size (inch)		Description										MSPN (CAI)			
28		13.6 R28 123A8/120B TL [Discontinued December 2022]										87976 (123782)			
Section Width	Overall Diam. (in.)	Loaded Radius (in.)	Rolling Circum. (in.)	Recommended Rim	Acceptable Rims					Min. Dual / Triple Spacing (in.)	75% internal volume (gal.)	Tread depth (32nd in.)			
14.6	51.5	23.3	153.3	W12	W11					18.3	45.6	58			
Psi	6	7	9	12	15	17	20	23	26	29	30	33	35	38	41
6 mph **			2625	3020	3350	3670	4000	4320	4650	4970					
20 mph			2050	2380	2635	2890	3155	3405							
25 mph			2225	2470	2700	2945	3175								
30 mph			2030	2240	2445	2670	2875								
25 mph Dual	1300	1630	1960	2170	2380	2590	2800								

* Refer to the notes at the end of the tables of this range

Tire specifications and pressure table. Load per tire in lbs.*

Rim Size (inch)		Description										MSPN (CAI)			
28		14.9 R28 134A8/131B TL [Discontinued August 2022]										25543 (112235)			
Section Width	Overall Diam. (in.)	Loaded Radius (in.)	Rolling Circum. (in.)	Recommended Rim	Acceptable Rims						Min. Dual / Triple Spacing (in.)	75% internal volume (gal.)	Tread depth (32nd in.)		
15.5	53.7	24.6	160.3	W13	W12						19.8	55.5	59		
Psi	6	7	9	12	15	17	20	23	26	29	30	33	35	38	41
6 mph **	2735	3010	3295	3845	4410	4960	5215	5455	5785	6120	6230	6450	6570	6790	7010
20 mph	1950	2160	2360	2710	3130	3540	3890	4245	4430	4630	4720	4905	5005		
25 mph			2205	2535	2920	3305	3640	3970	4145	4320	4410	4585	4675		
30 mph			2005	2305	2655	3010	3320	3615	3780	3935	4010	4180	4255		

Rim Size (inch)		Description										MSPN (CAI)			
28		16.9 R28 141A8/138B TL [Discontinued August 2022]										13991 (984997)			
Section Width	Overall Diam. (in.)	Loaded Radius (in.)	Rolling Circum. (in.)	Recommended Rim	Acceptable Rims						Min. Dual / Triple Spacing (in.)	75% internal volume (gal.)	Tread depth (32nd in.)		
17.9	56.5	25.8	168.4	DW15L	DW14L W14L W15L						22.3	71.7	64		
Psi	6	7	9	12	15	17	20	23	26	29	30	33	35	38	41
6 mph **	3305	3640	3970	4630	5290	5950	6285	6615	7010	7410	7550	7825	7970	8245	8520
20 mph	2360	2610	2865	3305	3780	4245	4695	5150	5380	5610	5730	5965	6075		
25 mph			2680	3085	3525	3970	4385	4805	5025	5245	5345	5565	5675		
30 mph			2435	2810	3220	3615	4000	4375	4575	4775	4870	5070	5170		

Rim Size (inch)		Description										MSPN (CAI)			
30		16.9 R30 137A8/134B TL [Discontinued August 2022]										41545 (123870)			
Section Width	Overall Diam. (in.)	Loaded Radius (in.)	Rolling Circum. (in.)	Recommended Rim	Acceptable Rims						Min. Dual / Triple Spacing (in.)	75% internal volume (gal.)	Tread depth (32nd in.)		
17.6	58.3	26.1	173	DW15L	DW14L W14L W15L						22.3	75.3	62		
Psi	6	7	9	12	15	17	20	23	26	29	30	33	35	38	41
6 mph **		3880	4495	4970	5455	5930	6415	6890	7365						
20 mph		3040	3525	3900	4290	4665	5050	5425							
25 mph			3305	3660	4010	4365	4720	5070							
30 mph			3085	3405	3725	4035	4355	4675							
25 mph Dual	1940	2425	2910	3220	3525	3845	4155	4465							

Rim Size (inch)		Description										MSPN (CAI)			
30		18.4 R30 142A8/139B TL [Discontinued December 2022]										42060 (123844)			
Section Width	Overall Diam. (in.)	Loaded Radius (in.)	Rolling Circum. (in.)	Recommended Rim	Acceptable Rims						Min. Dual / Triple Spacing (in.)	75% internal volume (gal.)	Tread depth (32nd in.)		
19.8	61	27.4	181.2	DW16L	DW15L W15L W16L						24.1	93.1	68		
Psi	6	7	9	12	15	17	20	23	26	29	30	33	35	38	41
6 mph **		4475	5180	5730	6285	6835	7395	7950	8500						
20 mph		3505	4055	4495	4940	5380	5820	6260							
25 mph			3790	4200	4610	5025	5435	5840							
30 mph			3525	3890	4255	4630	4995	5355							
25 mph Dual	2295	2820	3340	3705	4055	4420	4775	5135							

* Refer to the notes at the end of the tables of this range

Tire specifications and pressure table. Load per tire in lbs.*

Rim Size (inch)		Description								MSPN (CAI)					
30		380/85 R30 135A8/135B TL 14.9 R30 [DISCONTINUED]								18784 (836509)					
Section Width	Overall Diam. (in.)	Loaded Radius (in.)	Rolling Circum. (in.)	Recommended Rim	Acceptable Rims					Min. Dual / Triple Spacing (in.)	75% internal volume (gal.)	Tread depth (32nd in.)			
15.2	55.7	24.7	165.1	W12	W13					20.0	55.3	58			
Psi	6	7	9	12	15	17	20	23	26	29	30	33	35	38	41
6 mph **	3195	3450	3705	4200	4705	5205	5690	6175	6835						
20 mph	2335	2545	2755	3195	3695	4190	4630	5070							
25 mph			2600	3000	3430	3860	4330	4805							
30 mph			2600	3000	3415	3860	4330	4805							
25 mph Dual	1895	2095	2295	2635	3020	3395	3815	4235							

Rim Size (inch)		Description								MSPN (CAI)					
30		420/90 R30 147A8/147B TL [DISCONTINUED]								68713 (953332)					
Section Width	Overall Diam. (in.)	Loaded Radius (in.)	Rolling Circum. (in.)	Recommended Rim	Acceptable Rims					Min. Dual / Triple Spacing (in.)	75% internal volume (gal.)	Tread depth (32nd in.)			
17.4	60.4	27.2	179.4	DW13	DW14L W13 W14L					21.7	75.1	55			
Psi	6	7	9	12	15	17	20	23	26	29	30	33	35	38	41
6 mph **	3970	4310	4650	5325	6010	6690	7365	8045	8710	9370	9515	9790	9920	10065	10195
20 mph	2835	3130	3415	3970	4520	5070	5620	6175	6480	6780	6935	7230	7385		
25 mph			3195	3750	4275	4795	5325	5840	6120	6395	6495	6680	6780		
30 mph			3195	3750	4275	4795	5325	5840	6120	6395	6495	6680	6780		
25 mph Dual	2360	2590	2810	3295	3760	4220	4675	5135	5380	5620	5710	5875	5965		

Rim Size (inch)		Description								MSPN (CAI)					
34		18.4 R34 149A8/146B TL [Discontinued August 2022]								71754 (679786)					
Section Width	Overall Diam. (in.)	Loaded Radius (in.)	Rolling Circum. (in.)	Recommended Rim	Acceptable Rims					Min. Dual / Triple Spacing (in.)	75% internal volume (gal.)	Tread depth (32nd in.)			
19.3	65.4	29.4	194.5	DW16L	DW15L W15L W16L					24.1	104.4	68			
Psi	6	7	9	12	15	17	20	23	26	29	30	33	35	38	41
6 mph **	4365	4795	5225	6085	6945	7805	8170	8520	8995	9470	9710	10185	10415		
20 mph	3415	3890	4365	4760	5170	5565	6085	6605	7035	7465	7670				
25 mph			4080	4455	4830	5205	5690	6175	6570	6965	7165				
30 mph			3715	4100	4485	4870	5245	5620	5985	6350	6525				
25 mph Dual	2490	3040	3595	3955	4330	4695	5070	5435	5785	6130	6305				

Rim Size (inch)		Description								MSPN (CAI)					
34		320/85 R34 133A8/130B TL 12.4 R34 [DISCONTINUED]								73532 (122760)					
Section Width	Overall Diam. (in.)	Loaded Radius (in.)	Rolling Circum. (in.)	Recommended Rim	Acceptable Rims					Min. Dual / Triple Spacing (in.)	75% internal volume (gal.)	Tread depth (32nd in.)			
12.6	55.9	25.6	166.9	W10						17.1	41	49			
Psi	6	7	9	12	15	17	20	23	26	29	30	33	35	38	41
6 mph **	2680	2900	3110	3550	3980	4410	4885	5355	5765	6175	6250	6405	6480	6625	6780
20 mph	1875	2070	2270	2680	3055	3415	3805	4190	4365	4540	4610	4740	4805		
25 mph			2150	2470	2835	3195	3525	3860	4080	4300	4365	4485	4540		
30 mph			1985	2270	2600	2910	3220	3525	3750	3970	4025	4135	4190		
25 mph Dual	1555	1730	1895	2170	2490	2810	3110	3395	3595	3780	3835	3945	4000		

* Refer to the notes at the end of the tables of this range

Tire specifications and pressure table. Load per tire in lbs.*

Rim Size (inch)		Description										MSPN (CAI)			
34		380/85 R34 137A8/137B TL 14.9 R34 [DISCONTINUED]										59412 (122781)			
Section Width	Overall Diam. (in.)	Loaded Radius (in.)	Rolling Circum. (in.)	Recommended Rim	Acceptable Rims						Min. Dual / Triple Spacing (in.)	75% internal volume (gal.)	Tread depth (32nd in.)		
15.5	59.2	26.5	175.6	W12	W13						20.0	60.8	55		
Psi	6	7	9	12	15	17	20	23	26	29	30	33	35	38	41
6 mph **	3415	3680	3945	4465	4995	5510	6065	6615	7275						
20 mph	2470	2690	2910	3415	3915	4410	4885	5355							
25 mph			2755	3195	3640	4080	4575	5070							
30 mph			2755	3195	3640	4080	4575	5070							
25 mph Dual	1995	2215	2425	2810	3210	3595	4035	4465							

Rim Size (inch)		Description										MSPN (CAI)			
34		420/85 R34 147A8/147B TL 16.9 R34 [DISCONTINUED]										30127 (788910)			
Section Width	Overall Diam. (in.)	Loaded Radius (in.)	Rolling Circum. (in.)	Recommended Rim	Acceptable Rims						Min. Dual / Triple Spacing (in.)	75% internal volume (gal.)	Tread depth (32nd in.)		
17.9	62.8	28.5	187	DW15L	DW14L W13 W14L W15L						21.7	75.9	64		
Psi	6	7	9	12	15	17	20	23	26	29	30	33	35	38	41
6 mph **	3970	4275	4575	5180	5785	6395	7000	7605	8380	8920	9070	9390	9545	9865	10175
20 mph	2865	3155	3440	4000	4575	5135	5700	6250	6505	6755	6880	7130	7255		
25 mph			3195	3735	4265	4805	5325	5840	6075	6315	6425	6660	6780		
30 mph			3195	3735	4265	4805	5325	5840	6075	6315	6425	6660	6780		
25 mph Dual			2820	3295	3760	4235	4685	5135	5345	5555	5665	5875	5975		

Rim Size (inch)		Description										MSPN (CAI)			
36		12.4 R36 124A8/121B TL										03338 (123952)			
Section Width	Overall Diam. (in.)	Loaded Radius (in.)	Rolling Circum. (in.)	Recommended Rim	Acceptable Rims						Min. Dual / Triple Spacing (in.)	75% internal volume (gal.)	Tread depth (32nd in.)		
12.5	57.5	26.5	171.8	W11	W10						16.9	43.6	42		
Psi	6	7	9	12	15	17	20	23	26	29	30	33	35	38	41
6 mph **		2690	3130	3460	3790	4125	4465	4795	5125						
20 mph		2115	2445	2710	2975	3240	3505	3770							
25 mph			2295	2535	2790	3030	3285	3525							
30 mph			2115	2335	2545	2765	2975	3195							

Rim Size (inch)		Description										MSPN (CAI)			
38		12.4 R38 131A8/128B TL										15336 (258138)			
Section Width	Overall Diam. (in.)	Loaded Radius (in.)	Rolling Circum. (in.)	Recommended Rim	Acceptable Rims						Min. Dual / Triple Spacing (in.)	75% internal volume (gal.)	Tread depth (32nd in.)		
12.8	59.1	27.4	176.5	W11	DW10 W10						16.9	43.6	44		
Psi	6	7	9	12	15	17	20	23	26	29	30	33	35	38	41
6 mph **	2645	2900	3140	3640	4135	4630	4885	5125	5380	5620	5745	5995	6120		
20 mph	2060	2360	2645	2865	3085	3305	3660	4010	4245	4475	4595				
25 mph			2470	2680	2875	3085	3415	3750	3970	4190	4300				
30 mph			2250	2470	2690	2910	3165	3405	3605	3815	3915				
25 mph Dual	1500	1840	2170	2390	2625	2845	3075	3295	3495	3680	3780				

* Refer to the notes at the end of the tables of this range

Tire specifications and pressure table. Load per tire in lbs.*

Rim Size (inch)		Description										MSPN (CAI)			
38		13.6 R38 128A8/125B TL [Discontinued December 2022]										66666 (123992)			
Section Width	Overall Diam. (in.)	Loaded Radius (in.)	Rolling Circum. (in.)	Recommended Rim	Acceptable Rims					Min. Dual / Triple Spacing (in.)	75% internal volume (gal.)	Tread depth (32nd in.)			
14.1	61.6	28.4	185.2	DW12	W11 W12					18.3	57.4	57			
Psi	6	7	9	12	15	17	20	23	26	29	30	33	35	38	41
6 mph **		3040	3505	3880	4255	4630	5015	5390	5765						
20 mph		2380	2755	3055	3350	3660	3955	4255							
25 mph			2580	2515	2755	3010	3250	3970							
30 mph			2405	2645	2900	3140	3395	3640							
25 mph Dual	1510	1895	2270	2515	2755	3010	3250	3495							

Rim Size (inch)		Description										MSPN (CAI)			
38		18.4 R38 151A8/148B TL [Discontinued August 2022]										63603 (100097)			
Section Width	Overall Diam. (in.)	Loaded Radius (in.)	Rolling Circum. (in.)	Recommended Rim	Acceptable Rims					Min. Dual / Triple Spacing (in.)	75% internal volume (gal.)	Tread depth (32nd in.)			
19.4	69.7	31.5	207.4	DW16L	DW15L W15L W16L					24.1	113.9	68			
Psi	6	7	9	12	15	17	20	23	26	29	30	33	35	38	41
6 mph **	4630	5080	5545	6450	7365	8265	8640	9015	9535	10055	10305	10825	11080		
20 mph	3660	4135	4595	5025	5465	5895	6495	7075	7495	7925	8135				
25 mph			4300	4705	5105	5510	6065	6615	7010	7410	7605				
30 mph			3915	4330	4750	5170	5600	6020	6380	6745	6925				
25 mph Dual	2635	3210	3780	4190	4595	5005	5410	5820	6175	6515	6690				

Rim Size (inch)		Description										MSPN (CAI)			
38		20.8 R38 159A8/156B TL										17548 (813266)			
Section Width	Overall Diam. (in.)	Loaded Radius (in.)	Rolling Circum. (in.)	Recommended Rim	Acceptable Rims					Min. Dual / Triple Spacing (in.)	75% internal volume (gal.)	Tread depth (32nd in.)			
21.3	72.8	33	216.8	DW18L	DW16L DW18A W16L W18L					26.9	138.3	72			
Psi	6	7	9	12	15	17	20	23	26	29	30	33	35	38	41
6 mph **	5620	6195	6755	7905	9040	10175	10790	11410	12115	12820	13030	13435	13645	14065	14475
20 mph	4010	4440	4860	5565	6415	7255	8060	8850	9215	9590	9765	10130	10320		
25 mph			4540	5205	5995	6780	7530	8265	8610	8960	9125	9470	9645		
30 mph			4135	4740	5455	6175	6855	7530	7835	8155	8310	8620	8775		
25 mph Dual			3990	4575	5270	5965	6625	7275	7585	7880	8035	8335	8490		

Rim Size (inch)		Description										MSPN (CAI)			
38		380/95 R38 147A8/147B TL										65207 (836033)			
Section Width	Overall Diam. (in.)	Loaded Radius (in.)	Rolling Circum. (in.)	Recommended Rim	Acceptable Rims					Min. Dual / Triple Spacing (in.)	75% internal volume (gal.)	Tread depth (32nd in.)			
15.4	66.5	30.3	198.2	W12	W13					20.0	75.5	59			
Psi	6	7	9	12	15	17	20	23	26	29	30	33	35	38	41
6 mph **	4025	4365	4695	5380	6050	6735	7410	8090	8765	9040	9180	9470	9600	9890	10165
20 mph	2865	3155	3430	3990	4565	5125	5690	6250	6505	6755	6880	7130	7255		
25 mph			3195	3725	4255	4785	5315	5840	6075	6315	6425	6660	6780		
30 mph			3195	3725	4255	4785	5315	5840	6075	6315	6425	6660	6780		
25 mph Dual	2360	2535	2725	3075	3440	3805	4165	4520	4885	5245	5425	5785	5965		

* Refer to the notes at the end of the tables of this range

Tire specifications and pressure table. Load per tire in lbs.*

Rim Size (inch)		Description										MSPN (CAI)			
38		420/85 R38 144A8/144B TL 16.9 R38 [DISCONTINUED]										84239 (607820)			
Section Width	Overall Diam. (in.)	Loaded Radius (in.)	Rolling Circum. (in.)	Recommended Rim	Acceptable Rims					Min. Dual / Triple Spacing (in.)	75% internal volume (gal.)	Tread depth (32nd in.)			
17.9	66	29.5	195.9	DW15L	DW14L W14L W15L					21.7	82.2	64			
Psi	6	7	9	12	15	17	20	23	26	29	30	33	35	38	41
6 mph **	4190	4510	4830	5480	6120	6755	7410	8045	8850						
20 mph	3030	3330	3625	4220	4830	5425	6020	6615							
25 mph			3415	3970	4520	5070	5620	6175							
30 mph			3415	3970	4520	5070	5620	6175							
25 mph Dual	2490	2735	2985	3470	3970	4455	4950	5435							
Max 25 mph FRT					4760	5425	6085	6745	7410						

Rim Size (inch)		Description										MSPN (CAI)			
38		520/85 R38 155A8/155B TL 20.8 R38 [DISCONTINUED]										43308 (303668)			
Section Width	Overall Diam. (in.)	Loaded Radius (in.)	Rolling Circum. (in.)	Recommended Rim	Acceptable Rims					Min. Dual / Triple Spacing (in.)	75% internal volume (gal.)	Tread depth (32nd in.)			
20.9	73	32.3	217.7	DW16L	DD16 DD18 DW16A W16A W18A					26.4	134.3	64			
Psi	6	7	9	12	15	17	20	23	26	29	30	33	35	38	41
6 mph **	5840	6285	6725	7605	8490	9370	10195	11025	12205						
20 mph	4190	4630	5070	5840	6725	7605	8355	9095							
25 mph			4675	5510	6230	6945	7750	8545							
30 mph			4675	5510	6175	6965	7750	8545							
25 mph Dual	3395	3760	4110	4850	5480	6105	6810	7520							
Max 25 mph FRT					6615	7530	8435	9350	10250						

Rim Size (inch)		Description										MSPN (CAI)			
42		480/80 R42 156A8/156B TL 18.4 R42 [DISCONTINUED]										03395 (404096)			
Section Width	Overall Diam. (in.)	Loaded Radius (in.)	Rolling Circum. (in.)	Recommended Rim	Acceptable Rims					Min. Dual / Triple Spacing (in.)	75% internal volume (gal.)	Tread depth (32nd in.)			
19.4	73.1	33.3	218	DW16A	DD16 W16A					24.6	110.9	69			
Psi	6	7	9	12	15	17	20	23	26	29	30	33	35	38	41
6 mph **	5125	5525	5930	6725	7530	8320	9125	9920	10470	11025	11300	11850	12125	12675	13230
20 mph	3660	4035	4410	5150	5895	6645	7385	8135	8465	8785	8950	9270	9435		
25 mph			4080	4785	5490	6195	6900	7605	7915	8210	8365	8665	8820		
30 mph			4080	4785	5490	6195	6900	7605	7915	8210	8365	8665	8820		
25 mph Dual	2910	3230	3540	4165	4805	5435	6065	6690	6955	7230	7365	7630	7760		
Max 25 mph FRT					5730	6515	7310	8090	8885	9665	9820	10130	10275	10580	

Rim Size (inch)		Description										MSPN (CAI)			
42		520/85 R42 157A8/157B TL 20.8 R42 [DISCONTINUED]										63687 (122791)			
Section Width	Overall Diam. (in.)	Loaded Radius (in.)	Rolling Circum. (in.)	Recommended Rim	Acceptable Rims					Min. Dual / Triple Spacing (in.)	75% internal volume (gal.)	Tread depth (32nd in.)			
21.2	76.6	34.2	227.2	DW18A	DD18 W18A					26.4	143.8	74			
Psi	6	7	9	12	15	17	20	23	26	29	30	33	35	38	41
6 mph **	6175	6645	7110	8045	8985	9920	10805	11685	12930						
20 mph	4410	4805	5205	6175	7000	7825	8740	9645							
25 mph			4940	5675	6535	7385	8245	9095							
30 mph			4940	5675	6615	7385	8245	9095							
25 mph Dual	3595	3970	4345	4995	5755	6505	7255	8005							
Max 25 mph FRT					6810	7835	8865	9890	10915						

* Refer to the notes at the end of the tables of this range

Tire specifications and pressure table. Load per tire in lbs.*

Rim Size (inch)		Description										MSPN (CAI)			
46		420/80 R46 151A8/148B TL [DISCONTINUED]										58733 (122770)			
Section Width	Overall Diam. (in.)	Loaded Radius (in.)	Rolling Circum. (in.)	Recommended Rim	Acceptable Rims					Min. Dual / Triple Spacing (in.)	75% internal volume (gal.)	Tread depth (32nd in.)			
16.1	73.7	33.9	218.7	DW13	DW12					21.7	88.1	64			
Psi	6	7	9	12	15	17	20	23	26	29	30	33	35	38	41
6 mph **	4410	4785	5160	5895	6645	7385	8100	8820	9515	10195	10405	10815	11025	11190	11355
20 mph	3195	3470	3750	4410	5050	5675	6315	6945	7275	7605	7715	7935	8045		
25 mph			3525	4080	4720	5355	5875	6395	6780	7165	7275	7495	7605		
30 mph			3195	3750	4300	4940	5390	5840	6175	6615	6700	6865	6945		
25 mph Dual	2555	2835	3110	3595	4155	4720	5170	5620	5965	6305	6405	6590	6690		

Rim Size (inch)		Description										MSPN (CAI)			
46		480/80 R46 158A8/158B TL 18.4 R46 [DISCONTINUED]										94069 (637231)			
Section Width	Overall Diam. (in.)	Loaded Radius (in.)	Rolling Circum. (in.)	Recommended Rim	Acceptable Rims					Min. Dual / Triple Spacing (in.)	75% internal volume (gal.)	Tread depth (32nd in.)			
19.6	76.6	35	231.3	DW16A	DD16 DW16L W16A					24.6	118.7	68			
Psi	6	7	9	12	15	17	20	23	26	29	30	33	35	38	41
6 mph **	5455	5895	6340	7220	8100	8985	9865	10750	11300	11850	12125	12690	12965	13515	14065
20 mph	3900	4275	4650	5390	6140	6890	7630	8380	8795	9205	9415	9820	10030		
25 mph			4300	5005	5710	6415	7120	7825	8210	8600	8795	9180	9370		
30 mph			4300	5005	5710	6415	7120	7825	8210	8600	8795	9180	9370		
25 mph Dual	3195	3495	3780	4275	4775	5270	5765	6260	6755	7255	7505	8005	8245		
Max 25 mph FRT					6010	6825	7640	8445	9260	10075	10275	10660	10860	11245	

Rim Size (inch)		Description										MSPN (CAI)			
46		520/85 R46 158A8/155B TL 20.8 R46 [DISCONTINUED]										57479 (122780)			
Section Width	Overall Diam. (in.)	Loaded Radius (in.)	Rolling Circum. (in.)	Recommended Rim	Acceptable Rims					Min. Dual / Triple Spacing (in.)	75% internal volume (gal.)	Tread depth (32nd in.)			
20.3	80.7	36.2	239.7	DW16A	DW16L DW18A DW18L W16A W16L W18A W18L					26.4	153.5	73			
Psi	6	7	9	12	15	17	20	23	26	29	30	33	35	38	41
6 mph **	6395	6865	7330	8265	9205	10140	11080	12015	13380						
20 mph	4610	5060	5510	6415	7320	8225	9125	10030							
25 mph			5070	5930	6790	7650	8510	9370							
30 mph			4675	5445	6215	7000	7770	8545							
25 mph Dual	3780	4155	4530	5270	6020	6755	7495	8245							
Max 25 mph FRT					7120	8155	9180	10220	11245						

Rim Size (inch)		Description										MSPN (CAI)			
50		480/80 R50 159A8/159B TL [DISCONTINUED]										94576 (471947)			
Section Width	Overall Diam. (in.)	Loaded Radius (in.)	Rolling Circum. (in.)	Recommended Rim	Acceptable Rims					Min. Dual / Triple Spacing (in.)	75% internal volume (gal.)	Tread depth (32nd in.)			
18.7	80.9	37.1	241.5	DW15A	DW16A					24.6	126.6	71			
Psi	6	7	9	12	15	17	20	23	26	29	30	33	35	38	41
6 mph **	5675	6140	6605	7530	8445	9370	10360	11355	12290	13230	13395	13725	13890	14110	14330
20 mph	3970	4385	4805	5675	6425	7165	7990	8820	9235	9645	9790	10065	10195		
25 mph			4540	5205	5995	6780	7530	8265	8685	9095	9235	9515	9645		
30 mph			4540	5205	6010	6780	7530	8265	8545	9095	9235	9515	9645		
25 mph Dual	3295	3650	4000	4575	5270	5965	6625	7275	7640	8005	8125	8365	8490		
Max 25 mph FRT					6240	7120	8015	8895	9790	10670	10825	11120	11275	11575	

* Refer to the notes at the end of the tables of this range

Tire specifications and pressure table. Load per tire in lbs.*

Rim Size (inch)		Description										MSPN (CAI)			
50		480/95 R50 164A8/164B TL										54736 (491183)			
Section Width	Overall Diam. (in.)	Loaded Radius (in.)	Rolling Circum. (in.)	Recommended Rim	Acceptable Rims					Min. Dual / Triple Spacing (in.)	75% internal volume (gal.)	Tread depth (32nd in.)			
20.3	85.6	39.1	255.3	DW16B (A)	DW15B (A)					24.6	156.7	67			
Psi	6	7	9	12	15	17	20	23	26	29	30	33	35	38	41
6 mph **	6450	6835	7210	8335	9445	10570	11685	12810	13635	14460	14880	15710	16115	16325	16535
20 mph	4595	5080	5565	6515	7465	8420	9370	10320	10690	11055	11245	11605	11795		
25 mph			5205	6095	6980	7870	8750	9645	9985	10340	10505	10845	11025		
30 mph			5205	6095	6980	7870	8750	9645	9985	10340	10505	10845	11025		
25 mph Dual	3790	4190	4585	5370	6150	6925	7705	8490	8795	9095	9250	9545	9700		
Max 25 mph FRT					7320	8290	9270	10240	11220	12190	12370	12710	12885	13230	

*IMPORTANT:

The inflation pressure must always be appropriate for the load per tire, the speed of travel and the work to be done. Our recommendations above are provided subject to changes made after the date of publication of these tables. Technical data is subject to change without prior notice.

- For plowing and other field applications subject to high torque use the 20 mph line.

- When using single tire configuration:
 - add 6 psi for use on slopes of more than 20%
 - add 6 psi for intense road use exceeding 50%
- **6 mph LT (Low Torque) (max speed 6 mph).
- FRT: Free Rolling Tire



AGRIBIB® 2

ALL AROUND PERFORMING TIRE,
NOW OFFERS MORE

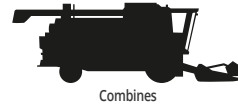
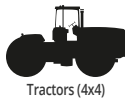

VERSATILITY

- For tractors from 60 to 170 HP and up to 500 HP with dual and triple fitments (42", 46", 50")



OPTIMAL TRACTION

- 45° lug angle for outstanding traction
- Enhanced self cleaning hinge design for maximum pulling power in wet conditions



LONG SERVICE LIFE

- Deep tread lugs are up to 8% deeper tread than the leading competitor's R1W offer¹
- Lug angle designed to protect against stubble
- Damage resistant compound, with 5/32nds extra rubber between lugs to fight stubble



HIGHER CARRYING CAPACITY

- Up to 18% higher load index²

(1) MICHELIN AGRIBIB 2 480/80R50 vs leading competitors published depths
(2) Depending on size & for size 520/85 R46 164A8/164B

SIZES

280/85 R24 120A8/120B TL	420/85 R28 144A8/144B TL	460/85 R34 152A8/152B TL	420/80 R46 151A8/151B TL
320/85 R24 127A8/127B TL	380/85 R30 140A8/140B TL	340/85 R38 138A8/138B TL	480/80 R46 158A8/158B TL
340/85 R24 130A8/130B TL	420/85 R30 145A8/139D TL	380/80 R38 142A8/139D TL	520/85 R46 164A8/164B TL
380/85 R24 137A8/137B TL	420/90 R30 147A8/147B TL	420/85 R38 149A8/149B TL	480/80 R50 159A8/159B TL
420/85 R24 142A8/142B TL	460/85 R30 150A8/150B TL	460/85 R38 154A8/154B TL	380/90 R54 152A8/152B TL
280/85 R28 123A8/120D TL	320/85 R34 133A8/133B TL	520/85 R38 160A8/160B TL	
340/85 R28 133A8/133B TL	380/85 R34 142A8/142B TL	480/80 R42 156A8/156B TL	
380/85 R28 139A8/139B TL	420/85 R34 147A8/147B TL	520/85 R42 162A8/162B TL	

AGRIBIB® 2

Tire specifications and pressure table. Load per tire in lbs.*

Rim Size (inch)		Description										MSPN (CAI)			
20		280/85 R24 120A8/120B TL [NEW 2nd Half 2022]										28293 (990406)			
Section Width	Overall Diam. (in.)	Loaded Radius (in.)	Rolling Circum. (in.)	Recommended Rim	Acceptable Rims						Min. Dual / Triple Spacing (in.)	75% internal volume (gal.)	Tread depth (32nd in.)		
11.4	43.0	19.8	128.4	W10	W9						15.3	23.4	52		
Psi	6	9	12	15	17	20	23	26	29	32	35	38	41	44	46
6 mph **	1850	2215	2580	2945	3265	3505	3715	3925	4135	4255	4385	4510	4630		
20 mph	1325	1575	1840	2095	2295	2490	2690	2890	3085	3195	3305				
25 mph		1475	1720	1960	2140	2325	2515	2700	2885	2985	3085				
30 mph		1475	1720	1960	2140	2325	2515	2700	2885	2985	3085				
25 mph Dual		1300	1510	1720	1885	2050	2205	2370	2535	2625	2710				

Rim Size (inch)		Description										MSPN (CAI)			
24		320/85 R24 127A8/127B TL [NEW 2nd Half 2022]										04692 (812603)			
Section Width	Overall Diam. (in.)	Loaded Radius (in.)	Rolling Circum. (in.)	Recommended Rim	Acceptable Rims						Min. Dual / Triple Spacing (in.)	75% internal volume (gal.)	Tread depth (32nd in.)		
13.0	45.2	20.5	134.7	W11	W10						17.1	31.8	53		
Psi	6	9	12	15	17	20	23	26	29	32	35	38	41	44	46
6 mph **	2215	2670	3120	3570	3970	4245	4495	4805	5125	5290	5455	5620	5785		
20 mph	1575	1905	2225	2555	2810	3065	3320	3585	3835	3990	4135				
25 mph		1820	2105	2390	2625	2865	3110	3340	3585	3725	3860				
30 mph		1820	2105	2390	2625	2865	3110	3340	3585	3725	3860				
25 mph Dual		1600	1850	2100	2315	2525	2735	2945	3155	3275	3395				

Rim Size (inch)		Description										MSPN (CAI)			
24		340/85 R24 130A8/130B TL [NEW 2nd Half 2022]										43288 (694878)			
Section Width	Overall Diam. (in.)	Loaded Radius (in.)	Rolling Circum. (in.)	Recommended Rim	Acceptable Rims						Min. Dual / Triple Spacing (in.)	75% internal volume (gal.)	Tread depth (32nd in.)		
14.3	47.3	21.5	140.9	W12	W11						18.2	36.7	54		
Psi	6	9	12	15	17	20	23	26	29	32	35	38	41	44	46
6 mph **	2480	2985	3495	3990	4495	4730	4960	5290	5620	5785	5950	6120	6285		
20 mph	1775	2125	2425	2820	3210	3550	3890	4045	4190	4345	4485				
25 mph		1985	2270	2635	3000	3320	3640	3780	3915	4055	4190				
30 mph		1985	2270	2635	3000	3320	3640	3780	3915	4055	4190				
25 mph Dual		1740	1995	2315	2635	2920	3195	3320	3440	3560	3680				

Rim Size (inch)		Description										MSPN (CAI)			
24		380/85 R24 137A8/137B TL [NEW 2nd Half 2022]										70692 (281463)			
Section Width	Overall Diam. (in.)	Loaded Radius (in.)	Rolling Circum. (in.)	Recommended Rim	Acceptable Rims						Min. Dual / Triple Spacing (in.)	75% internal volume (gal.)	Tread depth (32nd in.)		
15.4	49.3	22.1	146.4	W13	W11, W12						20.0	47.6	59		
Psi	6	9	12	15	17	20	23	26	29	32	35	38	41	44	46
6 mph **	2900	3495	4100	4695	5290	5545	5785	6205	6615	6865	7110	7365	7605		
20 mph	2060	2500	2955	3360	3770	4190	4595	4805	5015	5215	5425				
25 mph		2335	2755	3140	3525	3915	4300	4495	4685	4885	5070				
30 mph		2335	2755	3140	3525	3915	4300	4495	4685	4885	5070				
25 mph Dual		2060	2425	2765	3110	3450	3780	3955	4125	4300	4465				

* Refer to the notes at the end of the tables of this range

Tire specifications and pressure table. Load per tire in lbs.*

Rim Size (inch)		Description										MSPN (CAI)			
24		420/85 R24 142A8/142B TL [NEW 2nd Half 2022]										80487 (136458)			
Section Width	Overall Diam. (in.)	Loaded Radius (in.)	Rolling Circum. (in.)	Recommended Rim	Acceptable Rims						Min. Dual / Triple Spacing (in.)	75% internal volume (gal.)	Tread depth (32nd in.)		
17.5	52.8	23.5	157.0	DW15L	DW14L, W14L, W15L						21.7	60.2	70		
Psi	6	9	12	15	17	20	23	26	29	32	35	38	41	44	46
6 mph **	3405	4090	4760	5445	6120	6470	6810	7310	7805	8045	8290	8520	8765		
20 mph	2425	2955	3415	3890	4365	4895	5425	5635	5840	6040	6250				
25 mph		2755	3195	3640	4080	4575	5070	5270	5455	5655	5840				
30 mph		2755	3195	3640	4080	4575	5070	5270	5455	5655	5840				
25 mph Dual		2425	2810	3210	3595	4035	4465	4630	4805	4970	5135				

Rim Size (inch)		Description										MSPN (CAI)			
28		280/85 R28 123A8/120D TL										40217 (392931)			
Section Width	Overall Diam. (in.)	Loaded Radius (in.)	Rolling Circum. (in.)	Recommended Rim	Acceptable Rims						Min. Dual / Triple Spacing (in.)	75% internal volume (gal.)	Tread depth (32nd in.)		
11.8	46.9	21.5	140.3	W10	W9						15.3	25.8	50		
Psi	6	9	12	15	17	20	23	26	29	32	35	38	41	44	46
6 mph **	1985	2370	2745	3130	3505	3705	3900	4200	4495	4650	4815	4970	5125		
20 mph	1410	1675	1950	2225	2500	2810	3110	3250	3385	3525	3660				
25 mph		1565	1820	2085	2335	2625	2910	3040	3165	3295	3415				
30 mph		1420	1655	1895	2125	2390	2645	2765	2875	3000	3110				
40 mph		1420	1655	1895	2125	2390	2645	2765	2875	3000	3110				
25 mph Dual		1380	1600	1830	2060	2315	2555	2670	2790	2900	3010				

Rim Size (inch)		Description										MSPN (CAI)			
28		340/85 R28 133A8/133B TL [NEW 2nd Half 2022]										14834 (587209)			
Section Width	Overall Diam. (in.)	Loaded Radius (in.)	Rolling Circum. (in.)	Recommended Rim	Acceptable Rims						Min. Dual / Triple Spacing (in.)	75% internal volume (gal.)	Tread depth (32nd in.)		
14.3	51.5	23.3	153.3	W12	W11						18.2	40.8	54		
Psi	6	9	12	15	17	20	23	26	29	32	35	38	41	44	46
6 mph **	2645	3185	3725	4255	4795	5050	5290	5620	5950	6175	6380	6605	6810		
20 mph	1885	2240	2645	3030	3415	3780	4135	4320	4495	4685	4860				
25 mph		2095	2470	2835	3195	3525	3860	4035	4200	4375	4540				
30 mph		2095	2470	2835	3195	3525	3860	4035	4200	4375	4540				
25 mph Dual		1840	2170	2490	2810	3110	3395	3550	3705	3845	4000				

Rim Size (inch)		Description										MSPN (CAI)			
28		380/85 R28 139A8/139B TL [NEW 2nd Half 2022]										12989 (184281)			
Section Width	Overall Diam. (in.)	Loaded Radius (in.)	Rolling Circum. (in.)	Recommended Rim	Acceptable Rims						Min. Dual / Triple Spacing (in.)	75% internal volume (gal.)	Tread depth (32nd in.)		
15.7	53.6	24.3	159.6	W13	W12						20.0	52.7	58		
Psi	6	9	12	15	17	20	23	26	29	32	35	38	41	44	46
6 mph **	3140	3760	4385	5005	5620	5950	6285	6645	7010	7265	7530	7780	8035		
20 mph	2240	2710	3110	3560	4010	4440	4860	5080	5300	5510	5730				
25 mph		2535	2910	3330	3750	4145	4540	4750	4950	5160	5355				
30 mph		2535	2910	3330	3750	4145	4540	4750	4950	5160	5355				
25 mph Dual		2225	2555	2930	3295	3650	4000	4180	4365	4540	4720				

* Refer to the notes at the end of the tables of this range

AGRIBIB® 2

Tire specifications and pressure table. Load per tire in lbs.*

Rim Size (inch)		Description										MSPN (CAI)			
28		420/85 R28 144A8/144B TL [NEW 2nd Half 2022]										43824 (135905)			
Section Width	Overall Diam. (in.)	Loaded Radius (in.)	Rolling Circum. (in.)	Recommended Rim	Acceptable Rims					Min. Dual / Triple Spacing (in.)	75% internal volume (gal.)	Tread depth (32nd in.)			
17.7	55.9	25.4	166.4	DW15L	DW14L, W14L, W15L					21.7	65.6	62			
Psi	6	9	12	15	17	20	23	26	29	32	35	38	41	44	46
6 mph **	3705	4430	5160	5885	6615	7010	7410	7835	8265	8520	8765	9015	9260		
20 mph	2645	3110	3660	4190	4720	5225	5730	5950	6175	6380	6605				
25 mph		2910	3415	3915	4410	4885	5355	5565	5765	5975	6175				
30 mph		2910	3415	3915	4410	4885	5355	5565	5765	5975	6175				
25 mph Dual		2555	3010	3450	3880	4300	4720	4895	5080	5260	5435				

Rim Size (inch)		Description										MSPN (CAI)			
30		380/85 R30 140A8/140B TL										72163 (151572)			
Section Width	Overall Diam. (in.)	Loaded Radius (in.)	Rolling Circum. (in.)	Recommended Rim	Acceptable Rims					Min. Dual / Triple Spacing (in.)	75% internal volume (gal.)	Tread depth (32nd in.)			
15.5	55.7	25.4	166.1	W12	W13					20.0	60.4	59			
Psi	6	9	12	15	17	20	23	26	29	32	35	38	41	44	46
6 mph **	3230	3870	4510	5150	5785	6120	6450	6935	7410	7630	7835	8060	8265		
20 mph	2305	2790	3210	3670	4135	4640	5150	5335	5525	5710	5895				
25 mph		2600	3000	3430	3860	4330	4805	4980	5160	5335	5510				
30 mph		2600	3000	3430	3860	4330	4805	4980	5160	5335	5510				
25 mph Dual		2295	2635	3020	3395	3815	4235	4385	4540	4695	4850				

Rim Size (inch)		Description										MSPN (CAI)			
30		420/85 R30 145A8/139D TL [NEW 2nd Half 2022]										72159 (184330)			
Section Width	Overall Diam. (in.)	Loaded Radius (in.)	Rolling Circum. (in.)	Recommended Rim	Acceptable Rims					Min. Dual / Triple Spacing (in.)	75% internal volume (gal.)	Tread depth (32nd in.)			
17.6	58.5	26.3	173.9	DW15L	DW14L, W14L, W15L					21.7	71.3	63			
Psi	6	9	12	15	17	20	23	26	29	32	35	38	41	44	46
6 mph **	3805	4555	5315	6065	6810	7230	7650	8070	8520	8785	9050	9325	9590		
20 mph	2710	3240	3780	4310	4850	5380	5895	6140	6370	6615	6845				
25 mph		3000	3505	4010	4520	5025	5510	5730	5950	6175	6395				
30 mph		3000	3505	4000	4510	5005	5510	5730	5950	6175	6395				
25 mph Dual		2635	3085	3540	3980	4430	4850	5050	5235	5435	5620				

Rim Size (inch)		Description										MSPN (CAI)			
30		420/90 R30 147A8/147B TL										71308 (508522)			
Section Width	Overall Diam. (in.)	Loaded Radius (in.)	Rolling Circum. (in.)	Recommended Rim	Acceptable Rims					Min. Dual / Triple Spacing (in.)	75% internal volume (gal.)	Tread depth (32nd in.)			
16.5	59.8	26.9	177.7	DW13	DW14L W13 W14L					21.7	75.1	63			
Psi	6	9	12	15	17	20	23	26	29	32	35	38	41	44	46
6 mph **	4025	4675	5335	5985	6645	7295	7950	8610	9260	9490	9720	9945	10175		
20 mph	2865	3415	3990	4575	5150	5700	6250	6550	6845	7055	7255				
25 mph		3195	3750	4275	4805	5325	5840	6120	6395	6590	6780				
30 mph		3195	3750	4275	4805	5325	5840	6120	6395	6590	6780				
25 mph Dual	2360	2810	3295	3770	4235	4685	5135	5345	5555	5755	5965				

* Refer to the notes at the end of the tables of this range

AGRIBIB® 2

Tire specifications and pressure table. Load per tire in lbs.*

Rim Size (inch)		Description										MSPN (CAI)			
30		460/85 R30 150A8/150B TL [NEW 2nd Half 2022]										09713 (822467)			
Section Width	Overall Diam. (in.)	Loaded Radius (in.)	Rolling Circum. (in.)	Recommended Rim	Acceptable Rims						Min. Dual / Triple Spacing (in.)	75% internal volume (gal.)	Tread depth (32nd in.)		
19.4	61.3	27.6	181.5	DW16L	DW15L, W15L, W16L						23.5	86.2	68		
Psi	6	9	12	15	17	20	23	26	29	32	35	38	41	44	46
6 mph **	4365	5225	6085	6945	7805	8290	8765	9350	9920	10205	10505	10790	11080		
20 mph	3110	3770	4365	4970	5565	6205	6845	7110	7375	7640	7905				
25 mph		3525	4080	4640	5205	5800	6395	6645	6890	7145	7385				
30 mph		3525	4080	4640	5205	5800	6395	6645	6890	7145	7385				
25 mph Dual		3110	3595	4090	4575	5105	5620	5840	6065	6285	6505				

Rim Size (inch)		Description										MSPN (CAI)			
34		320/85 R34 133A8/133B TL										32034 (908266)			
Section Width	Overall Diam. (in.)	Loaded Radius (in.)	Rolling Circum. (in.)	Recommended Rim	Acceptable Rims						Min. Dual / Triple Spacing (in.)	75% internal volume (gal.)	Tread depth (32nd in.)		
12.3	55.9	25.7	167	W10							17.1	41	55		
Psi	6	9	12	15	17	20	23	26	29	32	35	38	41	44	46
6 mph **	2645	3185	3725	4255	4795	5050	5290	5620	5950	6175	6380	6605	6810		
20 mph	1885	2305	2645	3030	3415	3780	4135	4320	4495	4685	4860				
25 mph		2150	2470	2835	3195	3525	3860	4035	4200	4375	4540				
30 mph		2150	2470	2835	3195	3525	3860	4035	4200	4375	4540				
25 mph Dual	1555	1895	2170	2490	2810	3110	3395	3550	3705	3845	4000				

Rim Size (inch)		Description										MSPN (CAI)			
34		380/85 R34 142A8/142B TL										84143 (009860)			
Section Width	Overall Diam. (in.)	Loaded Radius (in.)	Rolling Circum. (in.)	Recommended Rim	Acceptable Rims						Min. Dual / Triple Spacing (in.)	75% internal volume (gal.)	Tread depth (32nd in.)		
14.9	59.7	27.2	177.9	W12	W13						20.0	75.5	59		
Psi	6	9	12	15	17	20	23	26	29	32	35	38	41	44	46
6 mph **	3405	4090	4760	5445	6120	6470	6810	7310	7805	8045	8290	8520	8765		
20 mph	2425	2955	3415	3890	4365	4895	5425	5635	5840	6040	6250				
25 mph		2755	3195	3640	4080	4575	5070	5270	5455	5655	5840				
30 mph		2755	3195	3640	4080	4575	5070	5270	5455	5655	5840				
25 mph Dual		2425	2810	3210	3595	4035	4465	4630	4805	4970	5135				

Rim Size (inch)		Description										MSPN (CAI)			
34		420/85 R34 147A8/147B TL										16801 (183733)			
Section Width	Overall Diam. (in.)	Loaded Radius (in.)	Rolling Circum. (in.)	Recommended Rim	Acceptable Rims						Min. Dual / Triple Spacing (in.)	75% internal volume (gal.)	Tread depth (32nd in.)		
17.7	62.6	28.3	186.2	DW15L	DW14L W13 W14L W15L						21.7	75.9	61		
Psi	6	9	12	15	17	20	23	26	29	32	35	38	41	44	46
6 mph **	4025	4815	5620	6415	7210	7630	8035	8530	9015	9305	9600	9890	10175		
20 mph	2865	3415	4010	4585	5150	5700	6250	6505	6755	7000	7255				
25 mph		3195	3750	4275	4805	5325	5840	6075	6315	6550	6780				
30 mph		3195	3750	4275	4805	5325	5840	6075	6315	6550	6780				
25 mph Dual	2360	2810	3295	3770	4235	4685	5135	5345	5555	5755	5965				

Tire specifications and pressure table. Load per tire in lbs.*

Rim Size (inch)		Description										MSPN (CAI)			
34		460/85 R34 152A8/152B TL [NEW 2nd Half 2022]										32288 (817711)			
Section Width	Overall Diam. (in.)	Loaded Radius (in.)	Rolling Circum. (in.)	Recommended Rim	Acceptable Rims						Min. Dual / Triple Spacing (in.)	75% internal volume (gal.)	Tread depth (32nd in.)		
19.4	65.0	29.2	193.2	DW16L	DW15L, W15L, W16L						23.5	93.7	68		
Psi	6	9	12	15	17	20	23	26	29	32	35	38	41	44	46
6 mph **	4630	5545	6450	7365	8265	8765	9260	9845	10415	10750	11080	11410	11740		
20 mph	3305	3890	4595	5245	5895	6580	7255	7540	7815	8100	8380				
25 mph		3640	4300	4905	5510	6150	6780	7045	7310	7560	7825				
30 mph		3640	4300	4905	5510	6150	6780	7045	7310	7560	7825				
25 mph Dual		3195	3780	4320	4850	5410	5965	6195	6425	6660	6890				

Rim Size (inch)		Description										MSPN (CAI)			
38		340/85 R38 138A8/138B TL [NEW 2nd Half 2022]										29111 (439359)			
Section Width	Overall Diam. (in.)	Loaded Radius (in.)	Rolling Circum. (in.)	Recommended Rim	Acceptable Rims						Min. Dual / Triple Spacing (in.)	75% internal volume (gal.)	Tread depth (32nd in.)		
14.1	61.3	28.3	183.4	DW12	W11, W12						18.2	51.1	54		
Psi	6	9	12	15	17	20	23	26	29	32	35	38	41	44	46
6 mph **	3065	3660	4265	4860	5455	5785	6120	6570	7010	7210	7410	7605	7805		
20 mph	2185	2645	3030	3460	3890	4375	4860	5040	5215	5390	5565				
25 mph		2470	2835	3240	3640	4090	4540	4705	4870	5040	5205				
30 mph		2470	2835	3240	3640	4090	4540	4705	4870	5040	5205				
25 mph Dual		2170	2490	2845	3195	3605	4000	4145	4290	4430	4575				

Rim Size (inch)		Description										MSPN (CAI)			
38		380/80 R38 142A8/139D TL										59112 (187095)			
Section Width	Overall Diam. (in.)	Loaded Radius (in.)	Rolling Circum. (in.)	Recommended Rim	Acceptable Rims						Min. Dual / Triple Spacing (in.)	75% internal volume (gal.)	Tread depth (32nd in.)		
15	62.8	28.7	187.2	DW12A	DW11 DW12 DW13 W11 W12 W13						20.0	60.8	58		
Psi	6	9	12	15	17	20	23	26	29	32	35	38	41	44	46
6 mph **	3405	4125	4850	5565	6285	6550	6810	7310	7805	8045	8290	8520	8765		
20 mph	2425	2955	3415	3955	4485	4960	5425	5635	5840	6040	6250				
25 mph		2755	3195	3695	4190	4630	5070	5270	5455	5655	5840				
30 mph		2755	3195	3695	4190	4630	5070	5270	5455	5655	5840				
40 mph		2515	2910	3360	3815	4220	4620	4795	4970	5135	5315				
25 mph Dual		2425	2810	3250	3680	4080	4465	4630	4805	4970	5135				

Rim Size (inch)		Description										MSPN (CAI)			
38		420/85 R38 149A8/149B TL										11069 (048439)			
Section Width	Overall Diam. (in.)	Loaded Radius (in.)	Rolling Circum. (in.)	Recommended Rim	Acceptable Rims						Min. Dual / Triple Spacing (in.)	75% internal volume (gal.)	Tread depth (32nd in.)		
17.7	66.5	30.3	198.2	DW15L	DW14L W14L W15L						21.7	77.5	62		
Psi	6	9	12	15	17	20	23	26	29	32	35	38	41	44	46
6 mph **	4255	4960	5675	6380	7090	7795	8510	9215	9920	10130	10340	10540	10750		
20 mph	3030	3660	4245	4840	5425	6020	6605	6935	7255	7465	7670				
25 mph		3415	3970	4520	5070	5620	6175	6480	6780	6980	7165				
30 mph		3415	3970	4520	5070	5620	6175	6480	6780	6980	7165				
25 mph Dual	2490	3010	3495	3980	4465	4950	5435	5655	5875	6085	6305				

* Refer to the notes at the end of the tables of this range

AGRIBIB® 2

Tire specifications and pressure table. Load per tire in lbs.*

Rim Size (inch)		Description										MSPN (CAI)			
38		460/85 R38 154A8/154B TL [NEW 2nd Half 2022]										75852 (346098)			
Section Width	Overall Diam. (in.)	Loaded Radius (in.)	Rolling Circum. (in.)	Recommended Rim	Acceptable Rims						Min. Dual / Triple Spacing (in.)	75% internal volume (gal.)	Tread depth (32nd in.)		
19.6	69.6	31.3	207.0	DW16L	DW15L, W15L, W16L						24.4	101.3	71		
Psi	6	9	12	15	17	20	23	26	29	32	35	38	41	44	46
6 mph **	4795	5785	6780	7770	8765	9180	9590	10340	11080	11925	12775	13625	14475		
20 mph	3415	4135	4860	5555	6250	6965	7670	7970	8265	8555	8850				
25 mph		3860	4540	5190	5840	6505	7165	7440	7715	7990	8265				
30 mph		3860	4540	5190	5840	6505	7165	7440	7715	7990	8265				
25 mph Dual		3395	4000	4575	5135	5720	6305	6550	6790	7035	7275				

Rim Size (inch)		Description										MSPN (CAI)			
38		520/85 R38 160A8/160B TL										05183 (882358)			
Section Width	Overall Diam. (in.)	Loaded Radius (in.)	Rolling Circum. (in.)	Recommended Rim	Acceptable Rims						Min. Dual / Triple Spacing (in.)	75% internal volume (gal.)	Tread depth (32nd in.)		
20.8	72.8	32.6	216.1	DW16L	DD16 DD18 DW18L W16A W18A						26.4	134.1	69		
Psi	6	9	12	15	17	20	23	26	29	32	35	38	41	44	46
6 mph **	5785	6770	7750	8730	9720	10705	11685	12665	13645	13955	14265	14575	14880		
20 mph	4135	5005	5810	6625	7430	8290	9140	9590	10030	10330	10615				
25 mph		4675	5510	6230	6945	7750	8545	8960	9370	9645	9920				
30 mph		4675	5510	6230	6945	7750	8545	8960	9370	9645	9920				
25 mph Dual	3395	4110	4850	5480	6105	6810	7520	7825	8125	8435	8730				

Rim Size (inch)		Description										MSPN (CAI)			
42		480/80 R42 156A8/156B TL										05745 (539386)			
Section Width	Overall Diam. (in.)	Loaded Radius (in.)	Rolling Circum. (in.)	Recommended Rim	Acceptable Rims						Min. Dual / Triple Spacing (in.)	75% internal volume (gal.)	Tread depth (32nd in.)		
19.3	72.4	33	215.4	DW16A	DD16 W16A						24.6	108.7	66		
Psi	6	9	12	15	17	20	23	26	29	32	35	38	41	44	46
6 mph **	5125	5995	6865	7725	8600	9470	10340	11200	12070	12355	12655	12940	13230		
20 mph	3660	4365	5115	5855	6605	7375	8135	8500	8850	9150	9435				
25 mph		4080	4805	5490	6175	6890	7605	7935	8265	8545	8820				
30 mph		4080	4805	5490	6175	6890	7605	7935	8265	8545	8820				
25 mph Dual	3010	3595	4235	4840	5435	6065	6690	6955	7230	7495	7760				

Rim Size (inch)		Description										MSPN (CAI)			
42		520/85 R42 162A8/162B TL										13435 (405859)			
Section Width	Overall Diam. (in.)	Loaded Radius (in.)	Rolling Circum. (in.)	Recommended Rim	Acceptable Rims						Min. Dual / Triple Spacing (in.)	75% internal volume (gal.)	Tread depth (32nd in.)		
21.3	77.1	34.9	228.7	DW18A	DD18 DW16A DW16L TW16L W16A W16L W18A						26.4	143.8	69		
Psi	6	9	12	15	17	20	23	26	29	32	35	38	41	44	46
6 mph **	6120	7165	8210	9250	10295	11345	12390	13425	14475	14780	15090	15400	15710		
20 mph	4365	5280	6150	7035	7905	8820	9735	10175	10615	10915	11210				
25 mph		4940	5675	6535	7385	8245	9095	9515	9920	10195	10470				
30 mph		4940	5675	6535	7385	8245	9095	9515	9920	10195	10470				
25 mph Dual	3595	4345	4995	5755	6505	7255	8005	8310	8610	8920	9215				

* Refer to the notes at the end of the tables of this range

AGRIBIB® 2

Tire specifications and pressure table. Load per tire in lbs.*

Rim Size (inch)		Description										MSPN (CAI)			
46		420/80 R46 151A8/151B TL										13581 (885138)			
Section Width	Overall Diam. (in.)	Loaded Radius (in.)	Rolling Circum. (in.)	Recommended Rim	Acceptable Rims						Min. Dual / Triple Spacing (in.)	75% internal volume (gal.)	Tread depth (32nd in.)		
16.1	73	33.2	217.5	DW13	DW12						21.7	88.1	63		
Psi	6	9	12	15	17	20	23	26	29	32	35	38	41	44	46
6 mph **	4365	5280	6205	7120	8035	8400	8765	9350	9920	10295	10670	11035	11410		
20 mph	3110	3770	4365	5050	5730	6295	6845	7165	7495	7815	8135				
25 mph		3525	4080	4720	5355	5875	6395	6700	7000	7310	7605				
30 mph		3525	4080	4720	5355	5875	6395	6700	7000	7310	7605				
25 mph Dual	2555	3110	3595	4155	4720	5170	5620	5885	6160	6425	6690				

Rim Size (inch)		Description										MSPN (CAI)			
46		480/80 R46 158A8/158B TL										00639 (622709)			
Section Width	Overall Diam. (in.)	Loaded Radius (in.)	Rolling Circum. (in.)	Recommended Rim	Acceptable Rims						Min. Dual / Triple Spacing (in.)	75% internal volume (gal.)	Tread depth (32nd in.)		
19.1	76.6	35.1	228.5	DW16A	DD16 DW16L W16A						24.6	118.7	66		
Psi	6	9	12	15	17	20	23	26	29	32	35	38	41	44	46
6 mph **	5455	6495	7530	8555	9590	10175	10750	11410	12070	12565	13060	13560	14055		
20 mph	3890	4595	5425	6140	6845	7615	8380	8795	9205	9625	10030				
25 mph		4300	5070	5730	6395	7110	7825	8210	8600	8985	9370				
30 mph		4300	5070	5730	6395	7110	7825	8210	8600	8985	9370				
25 mph Dual		3780	4465	5050	5620	6260	6890	7230	7575	7905	8245				

Rim Size (inch)		Description										MSPN (CAI)			
46		520/85 R46 164A8/164B TL										17697 (120922)			
Section Width	Overall Diam. (in.)	Loaded Radius (in.)	Rolling Circum. (in.)	Recommended Rim	Acceptable Rims						Min. Dual / Triple Spacing (in.)	75% internal volume (gal.)	Tread depth (32nd in.)		
20.4	81.1	36.7	240.6	DW16A	DW16L DW18A DW18L TW16L W16A W16L W18A W18L						26.4	147.8	69		
Psi	6	9	12	15	17	20	23	26	29	32	35	38	41	44	46
6 mph **	6450	7550	8665	9765	10880	11980	13085	14200	15300	15510	15720	15915	16125		
20 mph	4595	5425	6325	7230	8135	9085	10030	10470	10915	11355	11795				
25 mph		5070	6010	6810	7605	8490	9370	9790	10195	10615	11025				
30 mph		5070	6010	6810	7605	8490	9370	9790	10195	10615	11025				
25 mph Dual	3780	4465	5290	5995	6690	7475	8245	8610	8975	9335	9700				

Rim Size (inch)		Description										MSPN (CAI)			
50		480/80 R50 159A8/159B TL										41183 (263049)			
Section Width	Overall Diam. (in.)	Loaded Radius (in.)	Rolling Circum. (in.)	Recommended Rim	Acceptable Rims						Min. Dual / Triple Spacing (in.)	75% internal volume (gal.)	Tread depth (32nd in.)		
18.3	80.7	36.9	240.8	DW15A	DW16A						24.6	127.6	66		
Psi	6	9	12	15	17	20	23	26	29	32	35	38	41	44	46
6 mph **	5620	6755	7905	9040	10175	10790	11410	12115	12820	13240	13645	14065	14475		
20 mph	4010	4860	5565	6415	7255	8060	8850	9215	9590	9955	10320				
25 mph		4540	5205	5995	6780	7530	8265	8610	8960	9305	9645				
30 mph		4540	5205	5995	6780	7530	8265	8610	8960	9305	9645				
25 mph Dual		4000	4575	5270	5965	6625	7275	7585	7880	8190	8490				

* Refer to the notes at the end of the tables of this range

AGRIBIB® 2

Tire specifications and pressure table. Load per tire in lbs.*

Rim Size (inch)		Description								MSPN (CAI)					
54		380/90 R54 152A8/152B TL								28485 (075615)					
Section Width	Overall Diam. (in.)	Loaded Radius (in.)	Rolling Circum. (in.)	Recommended Rim		Acceptable Rims				Min. Dual / Triple Spacing (in.)	75% internal volume (gal.)	Tread depth (32nd in.)			
15.2	80.9	37.4	241.3	W12A		DW13B				20.0	88.1	63			
Psi	6	9	12	15	17	20	23	26	29	32	35	38	41	44	46
6 mph **	4495	5445	6380	7330	8265	8640	9015	9720	10415	10750	11080	11410	11740		
20 mph	3210	3890	4595	5245	5895	6495	7075	7410	7725	8060	8380				
25 mph		3640	4300	4905	5510	6065	6615	6925	7220	7530	7825				
30 mph		3640	4300	4905	5510	6065	6615	6925	7220	7530	7825				
25 mph Dual		3195	3780	4320	4850	5335	5820	6085	6360	6625	6890				

*IMPORTANT:

The inflation pressure must always be appropriate for the load per tire, the speed of travel and the work to be done. Our recommendations above are provided subject to changes made after the date of publication of these tables. Technical data is subject to change without prior notice.

- For plowing and other field applications subject to high torque use the 20 mph line.
- When using single tire configuration:

- add 6 psi for use on slopes of more than 20%
- add 6 psi for intense road use exceeding 50%
- **6 mph LT (Low Torque) (max speed 6 mph).



YELDBIB™

THE LOW-PRESSURE TIRE FOR HIGH-POWERED ROW-CROP APPLICATIONS

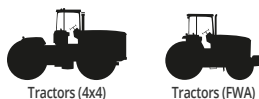

LESS PRESSURE, MORE YIELD

- +27% bigger Footprint¹
- VF – Very High Flexion Tire to carry more load with less air pressure
- Longer footprint for reduced soil compaction and increased yield
- Proven yield gain of 4% using Michelin Ultraflex tires²



VF Very High Flexion



TRACTION

- Outstanding traction thanks to 45° designed lugs³
- R1W lugs
- Optimized transfer of power to the ground for reduced fuel consumption



PRODUCTIVITY

- Same load capacity with 40% lower pressure vs standard radial



GREATER STUBBLE RESISTANCE

- Sweeping 45 degree tread design helps deflect stubble
- Additional reinforcement in the center of the tread to defend against stubble
- Exclusive rubber compound for added durability against chipping from stubble
- Extended Stubble Warranty

(1) Michelin test 2016, VF 480/80 R50 Yieldbib vs 480/80 R50 AGRIBIB.
 (2) Harper Adams University 2014/2016
 (3) Compared to standard competitor's tires with 23° lugs



Do not use MICHELIN YELDBIB on self propelled sprayers. For self propelled sprayers use MICHELIN SPRAYBIB tire range which was specifically designed to meet usage requirements (speed, load capacity, etc.).

SIZES

VF 380/85 R34 149A8/149B TL

VF 380/95 R38 154A8/154B TL

VF 480/95 R50 170A8/170B TL

VF 420/85 R34 154A8/154B TL

VF 480/80 R46 164A8/164B TL

VF 380/80 R38 149A8/149B TL

VF 480/80 R50 166A8/166B TL

YELDBIB™

Tire specifications and pressure table. Load per tire in lbs.*

Rim Size (inch)		Description										MSPN (CAI)	
34		VF 380/85 R34 149A8/149B TL										91239 (305457)	
Section Width	Overall Diam. (in.)	Loaded Radius (in.)	Rolling Circum. (in.)	Recommended Rim	Acceptable Rims					Min. Dual / Triple Spacing (in.)	75% internal volume (gal.)	Tread depth (32nd in.)	
14.6	59.4	26.3	176	W13	W12					20.1	60.8	55	
Psi	6	7	9	10	12	13	15	16	17	19	20	22	23
6 mph **	3515	3880	4245	4610	4970	5335	5700	6065	6425	6790	7155	7520	7880
20 mph	3265	3605	3935	4275	4610	4950	5290	5620	5965	6305	6635	6980	7310
30 mph	3195	3525	3860	4190	4520	4850	5180	5510	5840	6175	6505	6835	7165
20 mph Dual	2865	3165	3460	3760	4055	4355	4650	4950	5245	5545	5840	6130	6425
30 mph Dual	2820	3110	3405	3695	3980	4275	4565	4860	5150	5435	5730	6020	6305
30 mph Triple	2625	2900	3165	3440	3705	3980	4255	4520	4795	5070	5335	5610	5875
20 mph Triple	2680	2955	3230	3505	3780	4055	4345	4620	4895	5170	5445	5720	5995

Rim Size (inch)		Description										MSPN (CAI)	
34		VF 420/85 R34 154A8/154B TL										58965 (012445)	
Section Width	Overall Diam. (in.)	Loaded Radius (in.)	Rolling Circum. (in.)	Recommended Rim	Acceptable Rims					Min. Dual / Triple Spacing (in.)	75% internal volume (gal.)	Tread depth (32nd in.)	
17	62.3	27.5	184.3	DW15L	DW14A (L) W13 W14L W15A (L)					21.8	75.9	60	
Psi	6	7	9	10	12	13	15	16	17	19	20	22	23
6 mph **	4125	4540	4960	5380	5800	6215	6635	7045	7465	7870	8280	8685	9095
20 mph	3825	4210	4610	4995	5380	5765	6150	6525	6910	7295	7670	8060	8435
30 mph	3750	4135	4510	4895	5270	5645	6030	6405	6780	7155	7530	7895	8265
20 mph Dual	3360	3705	4045	4385	4730	5070	5410	5745	6085	6415	6755	7090	7420
30 mph Dual	3305	3640	3980	4310	4640	4970	5300	5635	5965	6295	6625	6945	7275
30 mph Triple	3075	3385	3705	4010	4320	4630	4940	5245	5555	5865	6175	6470	6780
20 mph Triple	3140	3460	3780	4090	4410	4730	5040	5355	5665	5975	6295	6605	6910

Rim Size (inch)		Description										MSPN (CAI)	
38		VF 380/80 R38 149A8/149B TL										35470 (870363)	
Section Width	Overall Diam. (in.)	Loaded Radius (in.)	Rolling Circum. (in.)	Recommended Rim	Acceptable Rims					Min. Dual / Triple Spacing (in.)	75% internal volume (gal.)	Tread depth (32nd in.)	
14.4	62.7	28	191	DW12A	W12 W13					20.1	60.8	57	
Psi	6	7	9	10	12	13	15	16	17	19	20	22	23
6 mph **	3515	3880	4255	4620	4980	5345	5710	6075	6435	6800	7165	7520	7880
20 mph	3265	3605	3945	4275	4620	4960	5300	5635	5975	6305	6645	6980	7310
30 mph	3195	3525	3870	4200	4530	4860	5190	5525	5855	6185	6515	6835	7165
20 mph Dual	2865	3165	3470	3770	4070	4365	4665	4960	5260	5555	5840	6140	6425
30 mph Dual	2820	3120	3415	3705	4000	4290	4585	4870	5160	5445	5730	6020	6305
30 mph Triple	2625	2900	3175	3440	3715	3990	4265	4530	4805	5070	5345	5610	5875
20 mph Triple	2680	2955	3240	3515	3790	4070	4345	4620	4895	5170	5445	5720	5995

* Refer to the notes at the end of the tables of this range

YELDBIB™

Tire specifications and pressure table. Load per tire in lbs.*

Rim Size (inch)		Description										MSPN (CAI)		
38		VF 380/95 R38 154A8/154B TL										47253 (873023)		
Section Width	Overall Diam. (in.)	Loaded Radius (in.)	Rolling Circum. (in.)	Recommended Rim	Acceptable Rims						Min. Dual / Triple Spacing (in.)	75% internal volume (gal.)	Tread depth (32nd in.)	
14.8	67	29.7	198.6	DW12A	W12						20.1	75.5	59	
Psi	6	7	9	10	12	13	15	16	17	19	20	22	23	
6 mph **	4125	4540	4960	5370	5785	6195	6615	7020	7430	7850	8265	8675	9095	
20 mph	3825	4210	4595	4980	5370	5755	6130	6515	6890	7275	7660	8045	8435	
30 mph	3750	4125	4510	4885	5260	5635	6010	6380	6755	7130	7520	7895	8265	
20 mph Dual	3360	3705	4045	4385	4730	5060	5400	5730	6065	6405	6745	7075	7420	
30 mph Dual	3305	3640	3970	4300	4630	4960	5290	5620	5950	6285	6615	6945	7275	
30 mph Triple	3085	3395	3705	4000	4310	4620	4925	5235	5545	5855	6160	6470	6780	
20 mph Triple	3140	3460	3770	4090	4400	4720	5025	5345	5655	5975	6285	6605	6910	

Rim Size (inch)		Description										MSPN (CAI)		
46		VF 480/80 R46 164A8/164B TL										10807 (842300)		
Section Width	Overall Diam. (in.)	Loaded Radius (in.)	Rolling Circum. (in.)	Recommended Rim	Acceptable Rims						Min. Dual / Triple Spacing (in.)	75% internal volume (gal.)	Tread depth (32nd in.)	
18.9	76.1	33.9	225.7	DW16A	DW15L DW16B DW16L W16A						24.6	118.7	66	
Psi	6	7	9	10	12	13	15	16	17	19	20	22	23	
6 mph **	5580	6130	6670	7220	7760	8310	8850	9405	9945	10495	11035	11585	12125	
20 mph	5170	5675	6185	6690	7200	7705	8210	8710	9215	9720	10230	10735	11245	
30 mph	5070	5565	6065	6560	7055	7550	8045	8545	9040	9535	10030	10525	11025	
20 mph Dual	4555	5005	5445	5895	6340	6780	7230	7670	8115	8565	9005	9460	9900	
30 mph Dual	4465	4905	5335	5775	6205	6645	7090	7520	7960	8400	8830	9270	9700	
30 mph Triple	4155	4565	4970	5380	5785	6195	6605	7000	7410	7815	8225	8630	9040	
20 mph Triple	4245	4665	5070	5490	5895	6315	6735	7145	7560	7980	8390	8805	9215	

Rim Size (inch)		Description										MSPN (CAI)		
50		VF 480/80 R50 166A8/166B TL										02098 (309830)		
Section Width	Overall Diam. (in.)	Loaded Radius (in.)	Rolling Circum. (in.)	Recommended Rim	Acceptable Rims						Min. Dual / Triple Spacing (in.)	75% internal volume (gal.)	Tread depth (32nd in.)	
18.4	80.3	35.5	237.6	DW16A(L)	DW15B (A) DW15L DW16B W15B (A) W16B						24.6	126.6	62	
Psi	6	7	9	10	12	13	15	16	17	19	20	22	23	
6 mph **	5720	6295	6865	7440	8015	8585	9160	9735	10305	10945	11585	12215	12855	
20 mph	5300	5830	6370	6900	7430	7960	8500	9030	9555	10150	10735	11330	11915	
30 mph	5205	5720	6250	6770	7285	7805	8335	8850	9370	9955	10525	11110	11685	
20 mph Dual	4665	5135	5600	6075	6535	7010	7475	7950	8410	8930	9445	9965	10485	
30 mph Dual	4575	5040	5500	5950	6415	6880	7330	7795	8245	8750	9260	9765	10275	
30 mph Triple	4255	4685	5115	5545	5975	6405	6835	7265	7695	8170	8640	9115	9590	
20 mph Triple	4345	4785	5225	5655	6095	6535	6965	7410	7835	8320	8805	9280	9765	

* Refer to the notes at the end of the tables of this range

YELDBIB™

Tire specifications and pressure table. Load per tire in lbs.*

Rim Size (inch)		Description										MSPN (CAI)	
50		VF 480/95 R50 170A8/170B TL										65206 (252129)	
Section Width	Overall Diam. (in.)	Loaded Radius (in.)	Rolling Circum. (in.)	Recommended Rim	Acceptable Rims						Min. Dual / Triple Spacing (in.)	75% internal volume (gal.)	Tread depth (32nd in.)
18.8	86.1	37.9	254.5	DW16L	DW15L (NRO) (NRO) W15L (NRO) (NRO) W16L						24.6	156.7	64
Psi	6	7	9	10	12	13	15	16	17	19	20	22	23
6 mph **	6615	7310	7990	8685	9370	10065	10750	11440	12125	12730	13340	13945	14550
20 mph	6130	6770	7410	8045	8685	9325	9965	10605	11245	11805	12370	12930	13490
30 mph	6010	6635	7265	7895	8520	9150	9780	10395	11025	11575	12125	12675	13230
20 mph Dual	5390	5950	6515	7075	7640	8200	8775	9335	9900	10395	10890	11375	11870
30 mph Dual	5290	5840	6395	6945	7495	8045	8600	9150	9700	10185	10670	11155	11640
30 mph Triple	4925	5445	5965	6470	6990	7505	8015	8530	9040	9490	9945	10395	10845
20 mph Triple	5025	5555	6075	6605	7120	7650	8170	8695	9215	9680	10140	10605	11065

***IMPORTANT:**

The inflation pressure must always be appropriate for the load per tire, the speed of travel and the work to be done. Our recommendations above are provided subject to changes made after the date of publication of these tables. Technical data is subject to change without prior notice.

- When using single tire configuration:
 - add 6 psi for use on slopes of more than 20%
 - add 6 psi for intense road use exceeding 50%
- **6 mph LT (Low Torque) (max speed 6 mph). For plowing and other field applications subject to high torque use the 20 mph line.



MACHXBIB®

HIGH FLOTATION R1W RADIAL WITH HUGE LOAD CARRYING CAPACITY



ROBUST PERFORMANCE

- Proven casing design
- A flat stable tread to spread very heavy loads evenly across the footprint



FUEL SAVINGS

- 4% FUEL SAVINGS, 0.26 Gallon (US) / hr compared to the main market competitor² (for a consumption on the road of 6.6 Gallon (US) / hr)



VERSATILITY

- Ideal for road transport: high speed rated with large lugs for long service life and low rolling resistance rubber mix for fuel efficiency
- Efficient in the field to transfer the torque of highpowered tractors to the ground
- Scraper Pan Warranty



EXCEPTIONAL COMFORT AND HANDLING

- The swept back 15° lug design delivers an exceptionally smooth ride on the road up to 40mph¹
- Ideal for transporting heavy loads



(1) When authorized by the laws in force in the country - depending on the size
 (2) Analytic test on MICHELIN tracks Ladoux Centre

SIZES

600/65 R28 154A8/154B TL	680/75 R32 164A8/161B TL	800/70 R38 173D TL
600/65 R28 154D/150E TL	650/60 R34 159D/155E TL	710/70 R42 173D TL
600/70 R28 157A8/157B TL	650/65 R34 161D/157E TL	710/75 R42 175D/171E TL
600/70 R28 157D/154E TL	650/75 R38 169A8/169B TL	900/50 R42 168D TL
600/70 R30 158D TL	650/75 R38 169D/165E TL	620/70 R46 162A8/162B TL
600/70 R30 TL 152D	650/85 R38 173A8/173B TL	620/70 R46 162D TL
710/55 R30 153D TL	710/70 R38 171D TL	

MACHXBIB®

Tire specifications and pressure table. Load per tire in lbs.*

Rim Size (inch)		Description										MSPN (CAI)			
28		600/65 R28 154A8/154B TL [DISCONTINUED]										86350 (135288)			
Section Width	Overall Diam. (in.)	Loaded Radius (in.)	Rolling Circum. (in.)	Recommended Rim	Acceptable Rims					Min. Dual / Triple Spacing (in.)	75% internal volume (gal.)	Tread depth (32nd in.)			
24.2	58.5	26.3	173.8	DW20B (A)	DW18L W18L					29.9	112.1	64			
Psi	6	9	12	15	17	20	23	25	26	28	29	32	35	38	41
6 mph **				6945	7725	8500	9280	9680	10065	10460	10845	11630	12410		
15 mph				5755	6450	7155	7850	8015	8180	8345	8510	8840	9170		
20 mph	3550	4220	4885	5555	6230	6890	7560	7725	7880	8045	8200	8520	8840		
25 mph				5490	5975	6460	6945	7110	7275	7440	7605	7935	8265		
30 mph					5975	6460	6945	7110	7275	7440	7605	7935	8265		
25 mph Dual	2910	3550	4190	4830	5260	5675	6105	6250	6405	6550	6690	6990	7275		

Rim Size (inch)		Description										MSPN (CAI)			
28		600/65 R28 154D/150E TL										44562 (429970)			
Section Width	Overall Diam. (in.)	Loaded Radius (in.)	Rolling Circum. (in.)	Recommended Rim	Acceptable Rims					Min. Dual / Triple Spacing (in.)	75% internal volume (gal.)	Tread depth (32nd in.)			
24.6	58.8	26.4	175.8	DW20B (A)	DW18L DW21B(A) W18L					29.9	107	68			
Psi	6	9	12	15	17	20	23	25	26	28	29	32	35	38	41
6 mph **	4960	5580	6195	6810	7595	8390	9170	9570	9965	10350	10750	11165	11575	11995	12400
20 mph	3805	4495	5205	5895	6590	7295	7990	8180	8380	8565	8750	9140	9515		
25 mph		4220	4895	5580	6250	6935	7605	7780	7970	8145	8335	8685	9050		
30 mph		4055	4705	5355	5995	6645	7295	7475	7650	7815	7990	8345	8685		
40 mph			4540	5150	5745	6350	6945	7110	7275	7440	7605	7935	8265		
43 mph				4135	4685	5235	5775	6325	6460	6590	6725	6855	7120	7385	
25 mph Dual	3185	3770	4355	4940	5525	6105	6690	6855	7010	7175	7330	7650	7970		

Rim Size (inch)		Description										MSPN (CAI)			
28		600/70 R28 157A8/157B TL [DISCONTINUED]										46139 (395016)			
Section Width	Overall Diam. (in.)	Loaded Radius (in.)	Rolling Circum. (in.)	Recommended Rim	Acceptable Rims					Min. Dual / Triple Spacing (in.)	75% internal volume (gal.)	Tread depth (32nd in.)			
24.5	62.4	27.6	184.8	DW20B (A)	DW18L					29.9	130.7	67			
Psi	6	9	12	15	17	20	23	25	26	28	29	32	35	38	41
6 mph **				7650	8500	9360	10205	10635	11065	11495	11925	12785	13645		
20 mph	3900	4760	5645	6515	7395	8265	9150	9225	9290	9370	9435	9580	9720		
25 mph				6285	7055	7825	8600	8665	8730	8785	8850	8985	9105		
30 mph					7055	7825	8600	8665	8730	8785	8850	8985	9105		
25 mph Dual	3165	3955	4740	5535	6205	6890	7560	7615	7670	7725	7795	7905	8015		

Rim Size (inch)		Description										MSPN (CAI)			
28		600/70 R28 157D/154E TL										29237 (211033)			
Section Width	Overall Diam. (in.)	Loaded Radius (in.)	Rolling Circum. (in.)	Recommended Rim	Acceptable Rims					Min. Dual / Triple Spacing (in.)	75% internal volume (gal.)	Tread depth (32nd in.)			
24.8	61.9	27.7	183.1	DW20B (A)	DW18L DW21B(A)					29.9	118.3	68			
Psi	6	9	12	15	17	20	23	25	26	28	29	32	35	38	41
6 mph **	5455	6175	6890	7605	8500	9390	10285	10735	11175	11630	12070	12465	12865	13250	13645
20 mph	4190	4995	5800	6605	7395	8200	9005	9195	9370	9555	9735	10095	10460		
25 mph		4705	5480	6250	7020	7795	8565	8740	8920	9085	9260	9610	9955		
30 mph		4520	5260	5995	6745	7485	8225	8390	8555	8720	8885	9215	9545		
40 mph			5070	5765	6450	7145	7825	7980	8145	8300	8465	8775	9095		
43 mph			4620	5245	5875	6495	7120	7265	7410	7550	7695	7980	8265		
25 mph Dual	3505	4180	4850	5525	6195	6865	7540	7695	7850	8005	8155	8455	8765		

* Refer to the notes at the end of the tables of this range

MACHXBIB®

Tire specifications and pressure table. Load per tire in lbs.*

Rim Size (inch)		Description										MSPN (CAI)			
30		600/70 R30 158D TL										68124 (566557)			
Section Width	Overall Diam. (in.)	Loaded Radius (in.)	Rolling Circum. (in.)	Recommended Rim	Acceptable Rims						Min. Dual / Triple Spacing (in.)	75% internal volume (gal.)	Tread depth (32nd in.)		
25.1	63.1	28.2	187.4	DW20B (A)	DW18L DW21B (A)						30.5	123.6	71		
Psi	6	9	12	15	17	20	23	25	26	28	29	32	35	38	41
6 mph **	5455	6240	7020	7805	8720	9645	10560	11025	11485	11940	12400	12820	13230	13645	14055
20 mph	4190	5040	5875	6725	7575	8410	9260	9445	9645	9835	10020	10405	10780		
25 mph		4830	5620	6415	7220	8015	8805	8995	9170	9360	9535	9900	10265		
30 mph		4630	5390	6160	6925	7695	8455	8630	8805	8975	9150	9500	9845		
40 mph			5205	5920	6625	7330	8045	8210	8380	8545	8710	9040	9370		
25 mph Dual	3505	4210	4915	5635	6340	7045	7750	7915	8070	8235	8390	8710	9030		

Rim Size (inch)		Description										MSPN (CAI)			
30		600/70 R30 TL 152D [DISCONTINUED]										76077 (334318)			
Section Width	Overall Diam. (in.)	Loaded Radius (in.)	Rolling Circum. (in.)	Recommended Rim	Acceptable Rims						Min. Dual / Triple Spacing (in.)	75% internal volume (gal.)	Tread depth (32nd in.)		
24.1	63.2	27.8	186.8	DW20B (A)	DW18L						30.5	120.4	71		
Psi	6	9	12	15	17	20	23	25	26	28	29	32	35	38	41
6 mph **	5510	6615	7165	8265	9205	10140	11080	11300	11530	11750					
20 mph	4220	5070	5910	6745	7585	8420	9260								
25 mph		4830	5620	6415	7220	8015	8805								
30 mph		4630	5390	6150	6925	7685	8445								
40 mph			5150	5875	6525	7175	7825								
25 mph Dual	3540	4255	4960	5655	6360	7055	7760								

Rim Size (inch)		Description										MSPN (CAI)			
30		710/55 R30 153D TL										03784 (992342)			
Section Width	Overall Diam. (in.)	Loaded Radius (in.)	Rolling Circum. (in.)	Recommended Rim	Acceptable Rims						Min. Dual / Triple Spacing (in.)	75% internal volume (gal.)	Tread depth (32nd in.)		
26.7	59.8	26.3	176.7	DW23B (A)							35.8	133.7	63		
Psi	6	9	12	15	17	20	23	25	26	28	29	32	35	38	41
6 mph **	5455	6525	7430	8320	9225	10120	11025	11375	11730	12080					
20 mph	4190	5005	5855	6700	7560	8410	9260								
25 mph		4775	5580	6395	7200	8015	8820								
30 mph		4575	5345	6120	6900	7670	8445								
40 mph			5070	5840	6580	7310	8045								
25 mph Dual	3505	4200	4905	5620	6325	7045	7750								

Rim Size (inch)		Description										MSPN (CAI)			
32		680/75 R32 164A8/161B TL XM28										80305 (123582)			
Section Width	Overall Diam. (in.)	Loaded Radius (in.)	Rolling Circum. (in.)	Recommended Rim	Acceptable Rims						Min. Dual / Triple Spacing (in.)	75% internal volume (gal.)	Tread depth (32nd in.)		
26.6	73.4	32.2	217	DW21B (A)	DW20B (A)						33.9	196.1	73		
Psi	6	9	12	15	17	20	23	25	26	28	29	32	35	38	41
6 mph **	7120	9765	10805	11850	12885	13935	14970	15500	16015	16535					
20 mph	5535	7670	8500	9325	10140	10970	11795								
25 mph		7165	7935	8710	9480	10250	11025								
30 mph		6725	7420	8115	8820	9515	10205								
25 mph Dual	4345	6305	6990	7660	8345	9015	9700								

* Refer to the notes at the end of the tables of this range

MACHXBIB®

Tire specifications and pressure table. Load per tire in lbs.*

Rim Size (inch)		Description										MSPN (CAI)			
34		650/60 R34 159D/155E TL										96892 (549996)			
Section Width	Overall Diam. (in.)	Loaded Radius (in.)	Rolling Circum. (in.)	Recommended Rim	Acceptable Rims						Min. Dual / Triple Spacing (in.)	75% internal volume (gal.)	Tread depth (32nd in.)		
25.9	65.5	29.6	194.9	DW21B (A)	DW20B (A) DW23B (A)						32.5	131.9	73		
Psi	6	9	12	15	17	20	23	25	26	28	29	32	35	38	41
6 mph **	5455	6175	6890	7605	8565	9525	10485	10970	11440	11925	12400	12920	13435	13955	14475
20 mph	4190	5040	5875	6725	7575	8410	9260	9490	9720	9945	10175	10635	11090		
25 mph		4830	5620	6415	7220	8015	8805	9030	9250	9470	9690	10120	10560		
30 mph		4630	5390	6160	6925	7695	8455	8665	8875	9085	9290	9710	10130		
40 mph			5070	5820	6560	7295	8045	8245	8445	8640	8850	9250	9645		
43 mph			4620	5290	5975	6645	7320	7475	7630	7780	7935	8235	8545		
25 mph Dual	3505	4210	4915	5635	6340	7045	7750	7950	8135	8335	8520	8905	9290		

Rim Size (inch)		Description										MSPN (CAI)			
34		650/65 R34 161D/157E TL										93805 (817386)			
Section Width	Overall Diam. (in.)	Loaded Radius (in.)	Rolling Circum. (in.)	Recommended Rim	Acceptable Rims						Min. Dual / Triple Spacing (in.)	75% internal volume (gal.)	Tread depth (32nd in.)		
26.2	68	30.7	202.1	DW21B (A)	DW20B (A) DW23B (A)						32.5	146.6	73		
Psi	6	9	12	15	17	20	23	25	26	28	29	32	35	38	41
6 mph **	5950	6810	7660	8520	9460	10405	11345	11815	12290	12755	13230	13745	14265	14780	15300
20 mph	4565	5445	6315	7200	8070	8940	9820	10140	10460	10770	11090	11410	11730		
25 mph		5260	6075	6900	7715	8545	9360	9655	9965	10265	10560	10870	11165		
30 mph		5050	5830	6615	7410	8190	8975	9260	9555	9845	10130	10415	10705		
40 mph			5675	6395	7110	7825	8545	8820	9095	9370	9645	9920	10195		
43 mph			5170	5820	6470	7120	7770	8025	8280	8520	8775	8940	9095		
25 mph Dual	3825	4565	5290	6030	6770	7495	8235	8500	8765	9030	9290	9555	9820		

Rim Size (inch)		Description										MSPN (CAI)			
38		650/75 R38 169A8/169B TL [DISCONTINUED]										86829 (219467)			
Section Width	Overall Diam. (in.)	Loaded Radius (in.)	Rolling Circum. (in.)	Recommended Rim	Acceptable Rims						Min. Dual / Triple Spacing (in.)	75% internal volume (gal.)	Tread depth (32nd in.)		
26.1	76.7	34.6	226.8	DW23B (A)	MW23B (A)						32.5	193.1	77		
Psi	6	9	12	15	17	20	23	25	26	28	29	32	35	38	41
6 mph **	7410	9150	10890	12630	13340	14045	14750	15125	15485	15860	16225	16965	17705	18440	19180
20 mph	5315	6780	8255	9720	10320	10915	11510	11785	12060	12325	12600	13150	13690		
25 mph		6010	7575	9125	9665	10205	10750	11000	11255	11510	11775	12280	12785		
30 mph		6010	7575	9125	9665	10205	10750	11000	11255	11510	11775	12280	12785		
25 mph Dual	4330	5565	6800	8035	8510	8985	9460	9680	9910	10130	10360	10805	11255		

Rim Size (inch)		Description										MSPN (CAI)			
38		650/75 R38 169D/165E TL										70375 (311026)			
Section Width	Overall Diam. (in.)	Loaded Radius (in.)	Rolling Circum. (in.)	Recommended Rim	Acceptable Rims						Min. Dual / Triple Spacing (in.)	75% internal volume (gal.)	Tread depth (32nd in.)		
27.9	76.7	34.3	227.8	DW23B (A)	MW23B (A)						32.5	193.1	83		
Psi	6	9	12	15	17	20	23	25	26	28	29	32	35	38	41
6 mph **	7410	9150	10890	12630	13545	14460	15375	15820	16260	16700	17140	17880	18520	19180	19840
20 mph	5675	6810	7950	9085	10220	11355	12490	12800	13105	13405	13715	14200	14705		
25 mph		6495	7575	8655	9735	10815	11895	12180	12480	12765	13050	13515	14000		
30 mph		6215	7265	8300	9335	10375	11410	11685	11960	12235	12510	12965	13425		
40 mph		5930	6925	7905	8885	9875	10860	11120	11385	11650	11915	12345	12785		
43 mph		5390	6295	7185	8090	8985	9890	10130	10375	10605	10845	11235	11355		
25 mph Dual		5710	6670	7615	8565	9525	10470	10725	10980	11235	11485	11895	12325		

* Refer to the notes at the end of the tables of this range

MACHXBIB®

Tire specifications and pressure table. Load per tire in lbs.*

Rim Size (inch)		Description										MSPN (CAI)			
38		650/85 R38 173A8/173B TL										89462 (118628)			
Section Width	Overall Diam. (in.)	Loaded Radius (in.)	Rolling Circum. (in.)	Recommended Rim	Acceptable Rims						Min. Dual / Triple Spacing (in.)	75% internal volume (gal.)	Tread depth (32nd in.)		
27	81.2	36.4	239.8	DW23B (A)	DW20B (A) MW23B (A)						32.5	227	81		
Psi	6	9	12	15	17	20	23	25	26	28	29	32	35	38	41
6 mph Cyc Dual				14110	14905	15695	16490	16900	17315	17725	18145	18970	19785	20615	21440
6 mph **	8265	10230	12190	14155	14945	15740	16535	16955	17360	17780	18190	19015	19840	20670	21495
20 mph	5950	7595	9250	10890	11565	12225	12895	13205	13505	13810	14120	14725	15335		
25 mph		6615	8420	10230	10825	11420	12015	12300	12600	12885	13175	13755	14330		
30 mph		6615	8420	10230	10825	11420	12015	12300	12600	12885	13175	13755	14330		
25 mph Dual	4850	6240	7615	9005	9525	10055	10570	10825	11080	11330	11595	12105	12610		

Rim Size (inch)		Description										MSPN (CAI)			
38		710/70 R38 171D TL										30751 (708197)			
Section Width	Overall Diam. (in.)	Loaded Radius (in.)	Rolling Circum. (in.)	Recommended Rim	Acceptable Rims						Min. Dual / Triple Spacing (in.)	75% internal volume (gal.)	Tread depth (32nd in.)		
28.1	77.7	34.3	228.5	DW23B (A)	DW25B (A) MW23B (A) MW25B (A)						35.8	214.1	78		
Psi	6	9	12	15	17	20	23	25	26	28	29	32	35	38	41
6 mph **	8025	9370	10715	12060	13250	14440	15640	16235	16830	17430	18025	18605	19180	19765	20340
20 mph	6150	7365	8575	9800	11010	12225	13435	13700	13975	14240	14515	15045	15585		
25 mph		7035	8210	9380	10515	11660	12800	13050	13315	13570	13825	14340	14850		
30 mph		6745	7870	8995	10085	11175	12270	12510	12765	13005	13250	13745	14230		
40 mph			7385	8465	9535	10615	11685	11915	12160	12390	12620	13095	13560		
25 mph Dual	5160	6175	7185	8210	9225	10240	11255	11485	11705	11940	12160	12610	13060		

Rim Size (inch)		Description										MSPN (CAI)			
38		800/70 R38 173D TL										29390 (887730)			
Section Width	Overall Diam. (in.)	Loaded Radius (in.)	Rolling Circum. (in.)	Recommended Rim	Acceptable Rims						Min. Dual / Triple Spacing (in.)	75% internal volume (gal.)	Tread depth (32nd in.)		
31.9	81.3	35.4	239.9	DW25B (A)	DW27B (A) MW25B (A)						39.7	282.9	77		
Psi	6	9	12	15	17	20	23	25	26	28	29	32	35	38	41
6 mph Cyc Dual				11595	13570	15530	17505	18495	19480	20460	21440				
6 mph **	9700	11275	12840	14420	15995	17560	19135	19920	20710	21495					
20 mph	7440	8950	10450	11960	13470	14970	16480								
25 mph		8510	9945	11385	12820	14265	15695								
30 mph		8155	9535	10915	12290	13670	15045								
40 mph			9070	10385	11695	13020	14330								
25 mph Dual	6230	7495	8750	10020	11275	12545	13800								

* Refer to the notes at the end of the tables of this range

Tire specifications and pressure table. Load per tire in lbs.*

Rim Size (inch)		Description										MSPN (CAI)			
42		710/70 R42 173D TL										31962 (790388)			
Section Width	Overall Diam. (in.)	Loaded Radius (in.)	Rolling Circum. (in.)	Recommended Rim	Acceptable Rims						Min. Dual / Triple Spacing (in.)	75% internal volume (gal.)	Tread depth (32nd in.)		
28.4	82.2	36.7	243.9	DW23B (A)	DW25B (A) MW23B (A) MW25B (A)						35.8	230.4	81		
Psi	6	9	12	15	17	20	23	25	26	28	29	32	35	38	41
6 mph Cyc Dual				9680	11440	13195	14960	15840	16710	17595	18475	19215	19950	20700	21440
6 mph **	8265	9645	11025	12400	13690	14980	16270	16920	17560	18210	18850	19510	20170	20835	21495
20 mph	6340	7650	8960	10275	11575	12885	14200	14485	14770	15060	15345	15905	16480		
25 mph		7240	8455	9655	10945	12225	13515	13790	14065	14330	14605	15155	15695		
30 mph		6945	8100	9260	10495	11730	12965	13230	13480	13745	14010	14530	15045		
40 mph			8820	10000	11165	12345	12600	12840	13095	13340	13835	14330			
25 mph Dual	5315	6415	7505	8610	9710	10805	11905	12145	12380	12620	12865	13340	13810		

Rim Size (inch)		Description										MSPN (CAI)			
42		710/75 R42 175D/171E TL										13444 (015540)			
Section Width	Overall Diam. (in.)	Loaded Radius (in.)	Rolling Circum. (in.)	Recommended Rim	Acceptable Rims						Min. Dual / Triple Spacing (in.)	75% internal volume (gal.)	Tread depth (32nd in.)		
27.3	85	38.1	252.3	DW23B (A)	DW25B (A)						35.8	229	77		
Psi	6	9	12	15	17	20	23	25	26	28	29	32	35	38	41
6 mph **	8765	10525	12290	14055	15545	17030	18520	19270	20005	20755	21495	22320	23150	23975	24800
20 mph	6725	8135	9555	10970	12380	13800	15210	15500	15785	16070	16360	16920	17495		
25 mph		7850	9170	10505	11830	13160	14485	14760	15025	15300	15575	16115	16655		
30 mph		7530	8795	10075	11345	12620	13890	14155	14405	14670	14935	15455	15970		
40 mph			8265	9515	10750	11995	13230	13480	13725	13975	14220	14715	15210		
43 mph			7530	8655	9790	10915	12035	12225	12425	12610	12800	13185	13560		
25 mph Dual	5635	6825	8005	9195	10375	11565	12745	12985	13230	13460	13700	14185	14660		

Rim Size (inch)		Description										MSPN (CAI)			
42		900/50 R42 168D TL										03779 (832458)			
Section Width	Overall Diam. (in.)	Loaded Radius (in.)	Rolling Circum. (in.)	Recommended Rim	Acceptable Rims						Min. Dual / Triple Spacing (in.)	75% internal volume (gal.)	Tread depth (32nd in.)		
34.3	77.6	34.3	229.4	DW27B (A)	DW28B (A) DW30B (A)						43.9	243.6	69		
Psi	6	9	12	15	17	20	23	25	26	28	29	32	35	38	41
6 mph **	8435	10085	11455	12810	14175	15530	16900	17440	17980	18520					
20 mph	6460	7740	9030	10320	11620	12910	14200								
25 mph		7365	8600	9820	11055	12280	13515								
30 mph		7055	8235	9415	10605	11785	12965								
40 mph			7825	9015	10130	11235	12345								
25 mph Dual	5410	6480	7560	8655	9735	10825	11905								

* Refer to the notes at the end of the tables of this range

Tire specifications and pressure table. Load per tire in lbs.*

Rim Size (inch)		Description									MSPN (CAI)				
46		620/70 R46 162A8/162B TL XM28 [DISCONTINUED]									69879 (122723)				
Section Width	Overall Diam. (in.)	Loaded Radius (in.)	Rolling Circum. (in.)	Recommended Rim	Acceptable Rims						Min. Dual / Triple Spacing (in.)	75% internal volume (gal.)	Tread depth (32nd in.)		
24.4	81.1	36.5	241	DW20B (A)							31.5	184.2	72		
Psi	6	9	12	15	17	20	23	25	26	28	29	32	35	38	41
6 mph **	6745	9260	10250	11245	12235	13240	14230	14725	15225	15720					
20 mph	5270	7275	8060	8840	9635	10415	11200								
25 mph		6810	7540	8280	9005	9745	10470								
30 mph		6810	7540	8280	9005	9745	10470								
25 mph Dual	4110	5995	6635	7285	7925	8575	9215								

Rim Size (inch)		Description									MSPN (CAI)				
46		620/70 R46 162D TL									01175 (131721)				
Section Width	Overall Diam. (in.)	Loaded Radius (in.)	Rolling Circum. (in.)	Recommended Rim	Acceptable Rims						Min. Dual / Triple Spacing (in.)	75% internal volume (gal.)	Tread depth (32nd in.)		
25.5	80.2	35.7	237.8	DW20B (A)	DW18L MW20B (A) TW20B						31.5	178.9	76		
Psi	6	9	12	15	17	20	23	25	26	28	29	32	35	38	41
6 mph **	7010	8170	9335	10495	11650	12820	13975	14550	15135	15710					
20 mph	5380	6495	7605	8720	9835	10935	12050								
25 mph		6215	7275	8320	9370	10415	11465								
30 mph		5965	6980	7980	8985	10000	11000								
40 mph			6615	7585	8545	9515	10470								
25 mph Dual	4510	5435	6370	7295	8225	9160	10085								

*IMPORTANT:

The inflation pressure must always be appropriate for the load per tire, the speed of travel and the work to be done. Our recommendations above are provided subject to changes made after the date of publication of these tables. Technical data is subject to change without prior notice.

• For plowing and other field applications subject to high torque use the 20 mph line.

- When using single tire configuration:
 - add 6 psi for use on slopes of more than 20%
 - add 6 psi for intense road use exceeding 50%
- **6 mph LT (Low Torque) (max speed 6 mph).
- FRT: Free Rolling Tire



AXIOBIB®

EXCELLENT TRACTION & SOIL PROTECTION

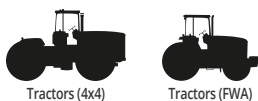

RETURN ON INVESTMENT

- Improved yields of +4%/Year¹
- Long tire life
- Scraper Pan Warranty



COMFORT

- Outstanding sidewall flexibility enhances operator comfort



EXCELLENT TRACTION

- +11% traction with AXIOBIB IF 710/70R42 vs standard 710/70R42



SOIL PROTECTION

- Low pressure up to 20% less versus standard radials



IF Increased Flexion



(1) Harper Adams University 2014/2016

SIZES

IF 600/70 R30 159D TL	IF 650/65 R38 169D TL	IF 710/75 R42 176D TL
IF 620/75 R30 164D TL	IF 650/85 R38 179D TL	IF 900/60 R42 186D TL
IF 650/75 R30 166D TL	IF 710/60 R38 172D TL	IF 750/75 R46 186D TL
IF 650/60 R34 165D TL	IF 710/85 R38 178D TL	IF 900/65 R46 190D TL
IF 650/65 R34 161D TL	IF 800/70 R38 179D TL	
IF 710/60 R34 164D TL	IF 710/70 R42 179D TL	

AXIOBIB®

Tire specifications and pressure table. Load per tire in lbs.*

Rim Size (inch)		Description										MSPN (CAI)			
30		IF 600/70 R30 159D TL [DISCONTINUED]										96393 (280086)			
Section Width	Overall Diam. (in.)	Loaded Radius (in.)	Rolling Circum. (in.)	Recommended Rim	Acceptable Rims						Min. Dual / Triple Spacing (in.)	75% internal volume (gal.)	Tread depth (32nd in.)		
24.1	62.4	27.4	184.4	DW21B (A)	DW20B (A)						30.5	118.9	71		
Psi	6	9	12	15	17	20	23	25	26	28	29	30	32	33	35
6 mph **			7100	8180	9260	10175	11090								
20mph			6415	7395	8365	9205	10030								
40 mph			6175	7110	8045	8850	9645								
40 mph Dual	3880	4650	5425	6250	7075	7780	8490								

Rim Size (inch)		Description										MSPN (CAI)			
30		IF 620/75 R30 164D TL										96772 (668406)			
Section Width	Overall Diam. (in.)	Loaded Radius (in.)	Rolling Circum. (in.)	Recommended Rim	Acceptable Rims						Min. Dual / Triple Spacing (in.)	75% internal volume (gal.)	Tread depth (32nd in.)		
25.9	65.7	28.7	194	DW23B (A)	DW21B (A) MW23B(A)						31.1	150.5	73		
Psi	6	9	12	15	17	20	23	25	26	28	29	30	32	33	35
6 mph **			7980	9060	10140	11410	12675								
20mph			7220	8200	9170	10320	11465								
40 mph			6945	7880	8820	9920	11025								
40 mph Dual	4345	5225	6105	6935	7760	8730	9700								

Rim Size (inch)		Description										MSPN (CAI)			
30		IF 650/75 R30 166D TL										96826 (828322)			
Section Width	Overall Diam. (in.)	Loaded Radius (in.)	Rolling Circum. (in.)	Recommended Rim	Acceptable Rims						Min. Dual / Triple Spacing (in.)	75% internal volume (gal.)	Tread depth (32nd in.)		
26.7	67.8	29.3	199.6	DW23B (A)	MW23B(A)						33.0	168.4	72		
Psi	6	9	12	15	17	20	23	25	26	28	29	30	32	33	35
6 mph **			8740	9920	11090	12270	13435								
20mph			7915	8975	10030	11090	12145								
40 mph			7605	8630	9645	10670	11685								
40 mph Dual	4720	5710	6700	7595	8490	9380	10275								

Rim Size (inch)		Description										MSPN (CAI)			
34		IF 650/60 R34 165D TL [DISCONTINUED]										94599 (100511)			
Section Width	Overall Diam. (in.)	Loaded Radius (in.)	Rolling Circum. (in.)	Recommended Rim	Acceptable Rims						Min. Dual / Triple Spacing (in.)	75% internal volume (gal.)	Tread depth (32nd in.)		
24.9	65.4	29.3	194.2	DW23B (A)	DW21B (A) DW24B (A)						32.7	131.9	73		
Psi	6	9	12	15	17	20	23	25	26	28	29	30	32	33	35
6 mph **			7100	8100	9105	10095	11090	11345	11585	11840	12080	12325	12565	12810	13050
20mph			6415	7330	8235	9140	10030	10250	10485	10705	10925	11145	11365	11585	11805
40 mph			6175	7045	7915	8785	9645	9865	10075	10295	10505	10715	10935	11145	11355
40 mph Dual	3880	4665	5435	6205	6965	7725	8490	8675	8865	9050	9235	9425	9610	9800	9985

* Refer to the notes at the end of the tables of this range

AXIOBIB®

Tire specifications and pressure table. Load per tire in lbs.*

Rim Size (inch)		Description										MSPN (CAI)			
34		IF 650/65 R34 161D TL [DISCONTINUED]										26241 (711975)			
Section Width	Overall Diam. (in.)	Loaded Radius (in.)	Rolling Circum. (in.)	Recommended Rim	Acceptable Rims						Min. Dual / Triple Spacing (in.)	75% internal volume (gal.)	Tread depth (32nd in.)		
25.7	67.8	30.1	200.7	DW23B (A)							32.7	146.6	73		
Psi	6	9	12	15	17	20	23	25	26	28	29	30	32	33	35
6 mph **			7795	8975	10140	10935	11730								
20mph			7055	8115	9170	9890	10605								
40 mph			6780	7805	8820	9515	10195								
40 mph Dual	4235	5105	5975	6865	7760	8365	8975								

Rim Size (inch)		Description										MSPN (CAI)			
34		IF 710/60 R34 164D TL [DISCONTINUED]										67777 (712503)			
Section Width	Overall Diam. (in.)	Loaded Radius (in.)	Rolling Circum. (in.)	Recommended Rim	Acceptable Rims						Min. Dual / Triple Spacing (in.)	75% internal volume (gal.)	Tread depth (32nd in.)		
27.9	66.8	29.8	198	DW25B (A)							35.4	162.4	73		
Psi	6	9	12	15	17	20	23	25	26	28	29	30	32	33	35
6 mph **			7980	9225	10460	11575	12675								
20mph			7220	8345	9460	10460	11465								
40 mph			6945	8025	9095	10065	11025								
40 mph Dual	4345	5225	6105	7055	8005	8850	9700								

Rim Size (inch)		Description										MSPN (CAI)			
38		IF 650/65 R38 169D TL										87017 (508421)			
Section Width	Overall Diam. (in.)	Loaded Radius (in.)	Rolling Circum. (in.)	Recommended Rim	Acceptable Rims						Min. Dual / Triple Spacing (in.)	75% internal volume (gal.)	Tread depth (32nd in.)		
25.6	71.9	32.8	214.4	DW23B (A)	DW21B (A) MW21B(A)						32.7	158.1	73		
Psi	6	9	12	15	17	20	23	25	26	28	29	30	32	33	35
6 mph **			8235	9350	10460	11410	12355	12655	12950	13240	13535	13835	14120	14420	14705
20mph			7450	8455	9460	10320	11175	11440	11720	11980	12245	12510	12775	13030	13295
40 mph			7165	8135	9095	9920	10750	11000	11265	11520	11775	12025	12280	12535	12785
40 mph Dual	4465	5390	6305	7155	8005	8730	9460	9680	9910	10130	10350	10570	10805	11025	11245

Rim Size (inch)		Description										MSPN (CAI)			
38		IF 650/85 R38 179D TL [DISCONTINUED]										97250 (084900)			
Section Width	Overall Diam. (in.)	Loaded Radius (in.)	Rolling Circum. (in.)	Recommended Rim	Acceptable Rims						Min. Dual / Triple Spacing (in.)	75% internal volume (gal.)	Tread depth (32nd in.)		
27.2	80.7	35.9	239.3	DW23B (A)	MW23B (A)						32.3	237.7	79		
Psi	6	9	12	15	17	20	23	25	26	28	29	30	32	33	35
6 mph **			10780	12300	13810	15400	16985	17370	17745	18135	18510	18795	19080	19370	19655
20mph			9745	11120	12500	13935	15365	15710	16050	16390	16735	17000	17250	17515	17770
40 mph			9370	10690	12015	13395	14770	15100	15430	15765	16095	16345	16590	16845	17085
40 mph Dual	5820	7035	8245	9415	10580	11795	13005	13295	13580	13865	14155	14375	14595	14815	15035

* Refer to the notes at the end of the tables of this range

AXIOBIB®

Tire specifications and pressure table. Load per tire in lbs.*

Rim Size (inch)		Description										MSPN (CAI)			
38		IF 710/60 R38 172D TL										69189 (220975)			
Section Width	Overall Diam. (in.)	Loaded Radius (in.)	Rolling Circum. (in.)	Recommended Rim	Acceptable Rims						Min. Dual / Triple Spacing (in.)	75% internal volume (gal.)	Tread depth (32nd in.)		
28	72.6	32.8	216	DW25B (A)							35.4	174.5	73		
Psi	6	9	12	15	17	20	23	25	26	28	29	30	32	33	35
6 mph **			8490	9735	10970	12205	13435	13755	14075	14385	14705	15025	15345	15655	15970
20mph			7685	8805	9920	11035	12145	12435	12720	13005	13295	13580	13865	14155	14440
40 mph			7385	8465	9535	10615	11685	11960	12235	12510	12785	13060	13340	13615	13890
40 mph Dual	5205	5910	6615	7520	8410	9305	10195	10450	10705	10955	11210	11465	11720	11970	12225

Rim Size (inch)		Description										MSPN (CAI)			
38		IF 710/85 R38 178D TL										99013 (992951)			
Section Width	Overall Diam. (in.)	Loaded Radius (in.)	Rolling Circum. (in.)	Recommended Rim	Acceptable Rims						Min. Dual / Triple Spacing (in.)	75% internal volume (gal.)	Tread depth (32nd in.)		
28.9	85	36.9	250.6	DW25B (A)	MW25B (A)						36.1	287.2	82		
Psi	6	9	12	15	17	20	23	25	26	28	29	30	32	33	35
6 mph **			12355	13975	15585	17305	19015								
20mph			11175	12645	14100	15655	17195								
40 mph			10750	12160	13560	15045	16535								
40 mph Dual	6700	8080	9460	10690	11925	13240	14550								

Rim Size (inch)		Description										MSPN (CAI)			
38		IF 800/70 R38 179D TL [DISCONTINUED]										99142 (528166)			
Section Width	Overall Diam. (in.)	Loaded Radius (in.)	Rolling Circum. (in.)	Recommended Rim	Acceptable Rims						Min. Dual / Triple Spacing (in.)	75% internal volume (gal.)	Tread depth (32nd in.)		
31.9	81.4	35.2	239.7	DW27B (A)							39.5	287.2	79		
Psi	6	9	12	15	17	20	23	25	26	28	29	30	32	33	35
6 mph **			12355	14165	15970	17815	19655								
20mph			11175	12810	14440	16105	17770								
40 mph			10750	12325	13890	15485	17085								
40 mph Dual	6700	8080	9460	10835	12215	13625	15035								

Rim Size (inch)		Description										MSPN (CAI)			
42		IF 710/70 R42 179D TL [DISCONTINUED]										99783 (771752)			
Section Width	Overall Diam. (in.)	Loaded Radius (in.)	Rolling Circum. (in.)	Recommended Rim	Acceptable Rims						Min. Dual / Triple Spacing (in.)	75% internal volume (gal.)	Tread depth (32nd in.)		
29.2	81.2	36.2	240.7	DW25B (A)	DW23B MW25B (A)						35.8	229.8	79		
Psi	6	9	12	15	17	20	23	25	26	28	29	30	32	33	35
6 mph **			10780	12300	13810	15400	16985	17370	17745	18135	18510	18795	19080	19370	19655
20mph			9745	11120	12500	13935	15365	15710	16050	16390	16735	17000	17250	17515	17770
40 mph			9370	10690	12015	13395	14770	15100	15430	15765	16095	16345	16590	16845	17085
40 mph Dual	5820	7035	8245	9415	10580	11795	13005	13295	13580	13865	14155	14375	14595	14815	15035

* Refer to the notes at the end of the tables of this range

AXIOBIB®

Tire specifications and pressure table. Load per tire in lbs.*

Rim Size (inch)		Description										MSPN (CAI)			
42		IF 710/75 R42 176D TL [DISCONTINUED]										25479 (037489)			
Section Width	Overall Diam. (in.)	Loaded Radius (in.)	Rolling Circum. (in.)	Recommended Rim	Acceptable Rims						Min. Dual / Triple Spacing (in.)	75% internal volume (gal.)	Tread depth (32nd in.)		
28.1	85.1	37.6	251.8	DW25B (A)							35.8	251.6	83		
Psi	6	9	12	15	17	20	23	25	26	28	29	30	32	33	35
6 mph **			11440	13085	14725	16370	18000								
20mph			10350	11840	13315	14805	16280								
40 mph			9955	11385	12810	14230	15655								
40 mph Dual	6270	7530	8775	10030	11275	12535	13780								

Rim Size (inch)		Description										MSPN (CAI)			
42		IF 900/60 R42 186D TL [DISCONTINUED]										82481 (111950)			
Section Width	Overall Diam. (in.)	Loaded Radius (in.)	Rolling Circum. (in.)	Recommended Rim	Acceptable Rims						Min. Dual / Triple Spacing (in.)	75% internal volume (gal.)	Tread depth (32nd in.)		
34.7	83.6	37.5	248.2	DW30B (A)							45.0	324.9	82		
Psi	6	9	12	15	17	20	23	25	26	28	29	30	32	33	35
6 mph **			12675	14585	16480	18385	20285	20755	21240	21715	22190	22665	23140	23610	24085
20mph			11465	13185	14905	16625	18340	18770	19200	19630	20060	20490	20920	21350	21780
40 mph			11025	12675	14330	15985	17635	18055	18465	18885	19290	19710	20115	20535	20945
40 mph Dual	7075	8390	9700	11155	12610	14065	15520	15885	16250	16610	16975	17340	17705	18065	18430

Rim Size (inch)		Description										MSPN (CAI)			
46		IF 750/75 R46 186D TL										07217 (487001)			
Section Width	Overall Diam. (in.)	Loaded Radius (in.)	Rolling Circum. (in.)	Recommended Rim	Acceptable Rims						Min. Dual / Triple Spacing (in.)	75% internal volume (gal.)	Tread depth (32nd in.)		
30	90	41.1	268.5	DW25B (A)							37.0	302.9	89		
Psi	6	9	12	15	17	20	23	25	26	28	29	30	32	33	35
6 mph **			13050	14770	16480	18385	20285	20755	21240	21715	22190	22665	23140	23610	24085
20mph			11805	13360	14905	16625	18340	18770	19200	19630	20060	20490	20920	21350	21780
40 mph			11355	12840	14330	15985	17635	18055	18465	18885	19290	19710	20115	20535	20945
40 mph Dual	7075	8530	9985	11300	12610	14065	15520	15885	16250	16610	16975	17340	17705	18065	18430

Rim Size (inch)		Description										MSPN (CAI)			
46		IF 900/65 R46 190D TL										36973 (162365)			
Section Width	Overall Diam. (in.)	Loaded Radius (in.)	Rolling Circum. (in.)	Recommended Rim	Acceptable Rims						Min. Dual / Triple Spacing (in.)	75% internal volume (gal.)	Tread depth (32nd in.)		
36	91.4	40.9	271.2	DW30B (A)	MW30B (A) TW30B						43.6	382.9	89		
Psi	6	9	12	15	17	20	23	25	26	28	29	30	32	33	35
6 mph **			14705	16865	19015	20600	22190	22775	23360	23940	24525	25110	25705	26290	26875
20mph			13295	15245	17195	18630	20060	20590	21120	21650	22180	22710	23250	23775	24305
40 mph			12785	14660	16535	17915	19290	19800	20315	20825	21330	21835	22355	22860	23370
40 mph Dual	8005	9635	11255	12910	14550	15765	16975	17430	17880	18320	18770	19225	19675	20115	20570

***IMPORTANT:**

The inflation pressure must always be appropriate for the load per tire, the speed of travel and the work to be done. Our recommendations above are provided subject to changes made after the date of publication of these tables. Technical data is subject to change without prior notice.

• For plowing and other field applications subject to high torque use the 20 mph line.

- When using single tire configuration:
 - add 6 psi for use on slopes of more than 20%
 - add 6 psi for intense road use exceeding 50%
- **6 mph LT (Low Torque) (max speed 6 mph).
- FRT: Free Rolling Tire





AXIOBIB® 2

HIGH TRACTION TIRE IDEAL FOR HEAVY LOADS

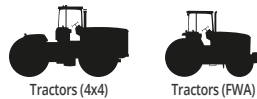

SOIL PROTECTION FOR INCREASED YIELD

- Very low pressure, up to a 40% reduction in pressure versus a standard radial
- Yields: +4%/Year²



OUTSTANDING TRACTION

- Improved traction up to 35%¹
- Low operating pressure for optimized power transfer of machine



PRODUCTIVITY GAINS

- Improved productivity, from +7% to +11%¹
- Huge load capacity; VF tires can carry 40% more load than a standard radial tire (at the same air pressure)

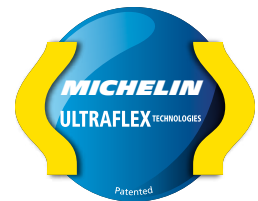

VF Very High Flexion



AIR SYSTEMS [⊕]
READY

Compatible with Central Tire Inflation Systems

(1) Internal test 2016, depending on the size. Comparing MICHELIN AXIOBIB 2 VF 650/85 R42 vs MICHELIN MACH-XBIB 650/85 R38.
(2) Harper Adams University 2014/2016

SIZES

VF 540/65 R30 158D/155E TL

VF 600/60 R30 162D/159E TL

VF 600/70 R30 168D/165E TL

VF 620/75 R30 172D/169E TL

VF 650/60 R34 168D/165E TL

VF 650/65 R34 170D/167E TL

VF 710/60 R34 173D/169E TL

VF 650/60 R38 170D/167E TL

VF 650/85 R38 182D/179E TL

VF 800/70 R38 187D/184E TL

VF 650/65 R42 174D/171E TL

VF 650/85 R42 183D/180E TL

VF 710/60 R42 176D/173E TL

VF 710/70 R42 182D/179E TL

VF 710/75 R42 184D/180E TL

VF 900/60 R42 189D/185E TL

VF 750/70 R44 186D/183E TL

AXIOBIB® 2

Tire specifications and pressure table. Load per tire in lbs.*

Rim Size (inch)		Description										MSPN (CAI)			
30		VF 540/65 R30 158D/155E TL										06869 (296638)			
Section Width	Overall Diam. (in.)	Loaded Radius (in.)	Rolling Circum. (in.)	Recommended Rim	Acceptable Rims						Min. Dual / Triple Spacing (in.)	75% internal volume (gal.)	Tread depth (32nd in.)		
21.1	57.5	25.2	169.9	W18L	W16L (NRO)						28.0	87.6	60		
Psi	6	9	12	13	15	16	17	19	20	22	23	25	26	28	29
6 mph **		5985	6990	7485	7980	8420	8875	9315	9755	10205	10650	10915	11190	11455	11720
20 mph		5170	6030	6460	6890	7275	7660	8045	8420	8805	9195	9425	9655	9890	10120
40 mph		4785	5590	5985	6380	6735	7100	7450	7805	8170	8520	8730	8950	9160	9370
43 mph		4355	5080	5445	5810	6130	6460	6780	7100	7430	7750	7950	8145	8345	8545
40 mph Dual	3415	4155	4885	5260	5620	5930	6250	6560	6865	7185	7495	7685	7870	8060	8245

Rim Size (inch)		Description										MSPN (CAI)			
30		VF 600/60 R30 162D/159E TL										06116 (371968)			
Section Width	Overall Diam. (in.)	Loaded Radius (in.)	Rolling Circum. (in.)	Recommended Rim	Acceptable Rims						Min. Dual / Triple Spacing (in.)	75% internal volume (gal.)	Tread depth (32nd in.)		
23.5	57.8	25.3	170.7	DW20B (A)	DW18L (NRO)						30.2	100.6	62		
Psi	6	9	12	13	15	16	17	19	20	22	23	25	26	28	29
6 mph **		5580	6535	7010	7485	7950	8420	8895	9370	9835	10305	10615	10915	11220	11520
20 mph		5170	6065	6505	6935	7375	7815	8245	8685	9115	9555	9845	10120	10405	10680
40 mph		5070	5940	6370	6800	7230	7660	8080	8510	8940	9370	9645	9920	10195	10470
43 mph		4620	5390	5775	6150	6535	6925	7330	7725	8135	8530	8785	9040	9280	9535
40 mph Dual	3780	4485	5270	5620	5975	6340	6690	7075	7475	7860	8245	8490	8730	8975	9215

Rim Size (inch)		Description										MSPN (CAI)			
30		VF 600/70 R30 168D/165E TL										32376 (426719)			
Section Width	Overall Diam. (in.)	Loaded Radius (in.)	Rolling Circum. (in.)	Recommended Rim	Acceptable Rims						Min. Dual / Triple Spacing (in.)	75% internal volume (gal.)	Tread depth (32nd in.)		
24.6	62.2	27.1	183.4	DW21B (A)	DW20B (A)						30.5	123.6	73		
Psi	6	9	12	13	15	16	17	19	20	22	23	25	26	28	29
6 mph **		7750	9050	9690	10340	10990	11630	12280	12920	13570	14210	14515	14825	15125	15430
20 mph		6700	7815	8380	8930	9490	10040	10605	11165	11720	12280	12545	12810	13075	13340
40 mph		6205	7240	7750	8265	8785	9305	9820	10330	10845	11365	11605	11860	12105	12345
43 mph		5645	6590	7055	7530	8005	8465	8940	9415	9875	10350	10605	10860	11100	11355
40 mph Dual	4465	5400	6340	6810	7275	7725	8190	8640	9095	9555	10010	10230	10440	10660	10870

Rim Size (inch)		Description										MSPN (CAI)			
30		VF 620/75 R30 172D/169E TL										20861 (702894)			
Section Width	Overall Diam. (in.)	Loaded Radius (in.)	Rolling Circum. (in.)	Recommended Rim	Acceptable Rims						Min. Dual / Triple Spacing (in.)	75% internal volume (gal.)	Tread depth (32nd in.)		
26.1	65.7	28.4	193.7	DW23B (A)	DW20B (A) DW21B (A)						32.0	146.8	73		
Psi	6	9	12	13	15	16	17	19	20	22	23	25	26	28	29
6 mph **		8695	10150	10870	11595	12325	13040	13770	14495	15210	15940	16290	16655	17010	17360
20 mph		7505	8765	9380	10010	10635	11265	11895	12510	13140	13770	14075	14385	14695	15000
40 mph		6955	8115	8695	9270	9855	10430	11010	11595	12170	12755	13040	13325	13605	13890
43 mph		6325	7385	7905	8435	8960	9490	10020	10550	11080	11605	11905	12205	12490	12785
40 mph Dual	5105	6120	7145	7650	8155	8665	9180	9690	10195	10715	11220	11475	11730	11970	12225

* Refer to the notes at the end of the tables of this range

AXIOBIB® 2

Tire specifications and pressure table. Load per tire in lbs.*

Rim Size (inch)		Description										MSPN (CAI)			
34		VF 650/60 R34 168D/168E TL										39440 (202185)			
Section Width	Overall Diam. (in.)	Loaded Radius (in.)	Rolling Circum. (in.)	Recommended Rim	Acceptable Rims					Min. Dual / Triple Spacing (in.)	75% internal volume (gal.)	Tread depth (32nd in.)			
26.7	65.1	28.8	192.7	DW23B (A)	DW21B (A) DW24B (A)					32.7	131.9	73			
Psi	6	9	12	13	15	16	17	19	20	22	23	25	26	28	29
6 mph **		7750	9050	9690	10340	10990	11630	12280	12920	13570	14210	14515	14825	15125	15430
20 mph		6700	7815	8380	8930	9490	10040	10605	11165	11720	12280	12545	12810	13075	13340
40 mph		6205	7240	7750	8265	8785	9305	9820	10330	10845	11365	11605	11860	12105	12345
43 mph		5645	6590	7055	7530	8005	8465	8940	9415	9875	10350	10605	10860	11100	11355
40 mph Dual	4465	5400	6340	6810	7275	7725	8190	8640	9095	9555	10010	10230	10440	10660	10870

Rim Size (inch)		Description										MSPN (CAI)			
34		VF 650/65 R34 170D/167E TL										79000 (101906)			
Section Width	Overall Diam. (in.)	Loaded Radius (in.)	Rolling Circum. (in.)	Recommended Rim	Acceptable Rims					Min. Dual / Triple Spacing (in.)	75% internal volume (gal.)	Tread depth (32nd in.)			
26.7	67.3	29.8	199.3	DW23B (A)	DW21B (A) / MW23B (A)					32.7	158.5	73			
Psi	6	9	12	13	15	16	17	19	20	22	23	25	26	28	29
6 mph **		8445	9855	10560	11265	11895	12520	13150	13780	14405	15035	15410	15785	16160	16535
20 mph		7295	8520	9125	9735	10275	10815	11365	11905	12445	12985	13315	13635	13965	14285
40 mph		6755	7880	8445	9005	9515	10010	10515	11025	11520	12025	12325	12630	12930	13230
43 mph		6150	7175	7695	8200	8665	9115	9580	10030	10495	10945	11210	11485	11750	12015
40 mph Dual	4995	5975	6945	7440	7925	8365	8805	9260	9700	10140	10580	10845	11110	11375	11640

Rim Size (inch)		Description										MSPN (CAI)			
34		VF 710/60 R34 173D/169E TL										99540 (757609)			
Section Width	Overall Diam. (in.)	Loaded Radius (in.)	Rolling Circum. (in.)	Recommended Rim	Acceptable Rims					Min. Dual / Triple Spacing (in.)	75% internal volume (gal.)	Tread depth (32nd in.)			
28.7	68	29.7	200.5	DW25B (A)	DW23B (A) (NRO) MW25B (A)					35.4	161.8	73			
Psi	6	9	12	13	15	16	17	19	20	22	23	25	26	28	29
6 mph **		8750	10205	10935	11660	12390	13120	13855	14585	15310	16040	16515	16975	17450	17915
20 mph		7560	8820	9445	10075	10705	11330	11970	12600	13230	13855	14265	14670	15070	15475
40 mph		7000	8170	8750	9335	9920	10505	11090	11660	12245	12830	13205	13580	13955	14330
43 mph		6370	7430	7960	8490	9015	9545	10085	10615	11145	11675	11950	12235	12510	12785
40 mph Dual	5135	6160	7185	7705	8210	8730	9235	9755	10265	10780	11290	11620	11950	12280	12610

Rim Size (inch)		Description										MSPN (CAI)			
38		VF 650/60 R38 170D/167E TL										44502 (908973)			
Section Width	Overall Diam. (in.)	Loaded Radius (in.)	Rolling Circum. (in.)	Recommended Rim	Acceptable Rims					Min. Dual / Triple Spacing (in.)	75% internal volume (gal.)	Tread depth (32nd in.)			
26.3	68.6	30.4	202.6	DW23B (A)	DW20B (A) (NRO) MW23B (A)					32.7	142.6	73			
Psi	6	9	12	13	15	16	17	19	20	22	23	25	26	28	29
6 mph **		8035	9380	10040	10715	11385	12060	12730	13395	14065	14740	15190	15640	16085	16535
20 mph		6945	8100	8685	9260	9845	10415	11000	11575	12160	12730	13120	13515	13900	14285
40 mph		6425	7505	8035	8575	9115	9645	10185	10715	11255	11785	12145	12510	12865	13230
43 mph		5855	6835	7320	7805	8290	8775	9270	9755	10240	10725	11045	11375	11695	12015
40 mph Dual	4720	5655	6605	7065	7540	8015	8490	8960	9425	9900	10375	10690	11010	11320	11640

* Refer to the notes at the end of the tables of this range

AXIOBIB® 2

Tire specifications and pressure table. Load per tire in lbs.*

Rim Size (inch)		Description										MSPN (CAI)			
38		VF 650/85 R38 182D/179E TL										18612 (655949)			
Section Width	Overall Diam. (in.)	Loaded Radius (in.)	Rolling Circum. (in.)	Recommended Rim	Acceptable Rims						Min. Dual / Triple Spacing (in.)	75% internal volume (gal.)	Tread depth (32nd in.)		
26.8	81.2	35.4	239.7	DW23B (A)	DW20B (A) DW21B						33.3	226.2	79		
Psi	6	9	12	13	15	16	17	19	20	22	23	25	26	28	29
6 mph **		11605	13545	14505	15475	16445	17405	18375	19345	20305	21275	21815	22355	22885	23425
20 mph		10030	11705	12535	13370	14210	15045	15885	16710	17550	18385	18850	19310	19775	20240
40 mph		9280	10835	11605	12380	13150	13920	14705	15475	16250	17020	17450	17880	18310	18740
43 mph		8445	9855	10560	11265	11970	12675	13380	14075	14780	15485	15885	16290	16690	17085
40 mph Dual	6890	8225	9555	10230	10890	11575	12260	12940	13615	14295	14980	15355	15740	16115	16490

Rim Size (inch)		Description										MSPN (CAI)			
38		VF 800/70 R38 187D/184E TL										86394 (136377)			
Section Width	Overall Diam. (in.)	Loaded Radius (in.)	Rolling Circum. (in.)	Recommended Rim	Acceptable Rims						Min. Dual / Triple Spacing (in.)	75% internal volume (gal.)	Tread depth (32nd in.)		
32.3	81.6	35.1	240	DW27B (A)	DW25B (A)						39.5	283.5	79		
Psi	6	9	12	13	15	16	17	19	20	22	23	25	26	28	29
6 mph **		13480	15730	16855	17980	19105	20225	21350	22465	23590	24715	25255	25795	26335	26875
20 mph		11650	13590	14560	15530	16500	17470	18440	19410	20380	21350	21815	22290	22750	23215
40 mph		10780	12590	13480	14385	15290	16180	17085	17980	18885	19775	20205	20635	21065	21495
43 mph		9810	11455	12270	13085	13900	14715	15545	16360	17175	17990	18455	18915	19380	19840
40 mph Dual	8005	9555	11100	11885	12655	13450	14240	15035	15820	16610	17405	17780	18165	18540	18915

Rim Size (inch)		Description										MSPN (CAI)			
42		VF 650/65 R42 174D/171E TL										43835 (387916)			
Section Width	Overall Diam. (in.)	Loaded Radius (in.)	Rolling Circum. (in.)	Recommended Rim	Acceptable Rims						Min. Dual / Triple Spacing (in.)	75% internal volume (gal.)	Tread depth (32nd in.)		
26.2	75.6	33.3	223.6	DW23B (A)	DW20B (A) (NRO) DW21B(A)						32.7	169.8	73		
Psi	6	9	12	13	15	16	17	19	20	22	23	25	26	28	29
6 mph **		9315	10870	11650	12425	13120	13800	14495	15190	15875	16570	17040	17515	17990	18465
20 mph		8045	9390	10055	10725	11320	11925	12520	13120	13725	14320	14725	15135	15545	15950
40 mph		7450	8695	9315	9930	10485	11045	11595	12145	12710	13260	13635	14020	14395	14770
43 mph		6780	7915	8475	9040	9545	10040	10550	11055	11550	12060	12435	12810	13185	13560
40 mph Dual	5435	6535	7640	8190	8740	9225	9710	10205	10690	11175	11660	11995	12335	12665	12995

Rim Size (inch)		Description										MSPN (CAI)			
42		VF 650/85 R42 183D/180E TL										06000 (530764)			
Section Width	Overall Diam. (in.)	Loaded Radius (in.)	Rolling Circum. (in.)	Recommended Rim	Acceptable Rims						Min. Dual / Triple Spacing (in.)	75% internal volume (gal.)	Tread depth (32nd in.)		
26.4	85.2	37.3	251.7	DW23B (A)	DW21B(A)						33.3	241.3	77		
Psi	6	9	12	13	15	16	17	19	20	22	23	25	26	28	29
6 mph **		12125	14145	15155	16160	17175	18175	19190	20205	21210	22225	22695	23170	23645	24120
20 mph		10470	12215	13085	13955	14825	15695	16580	17450	18320	19190	19600	20020	20425	20835
40 mph		9700	11320	12125	12930	13735	14540	15355	16160	16965	17770	18155	18530	18915	19290
43 mph		8820	10295	11025	11760	12500	13230	13965	14705	15430	16170	16535	16910	17275	17635
40 mph Dual	7075	8510	9945	10660	11375	12090	12800	13515	14220	14935	15640	15970	16315	16645	16975

* Refer to the notes at the end of the tables of this range

AXIOBIB® 2

Tire specifications and pressure table. Load per tire in lbs.*

Rim Size (inch)		Description										MSPN (CAI)			
42		VF 710/60 R42 176D/173E TL										78256 (941770)			
Section Width	Overall Diam. (in.)	Loaded Radius (in.)	Rolling Circum. (in.)	Recommended Rim	Acceptable Rims						Min. Dual / Triple Spacing (in.)	75% internal volume (gal.)	Tread depth (32nd in.)		
28.7	74.2	32.7	219.4	DW25B (A)	DW23B (A) (NRO) MW25B (A)						35.4	187.4	73		
Psi	6	9	12	13	15	16	17	19	20	22	23	25	26	28	29
6 mph **		9645	11255	12060	12865	13670	14475	15280	16070	16875	17680	18155	18630	19090	19565
20 mph		8335	9720	10415	11110	11805	12500	13195	13890	14585	15280	15685	16095	16500	16910
40 mph		7715	9005	9645	10285	10925	11575	12215	12855	13505	14145	14515	14905	15280	15655
43 mph		7020	8190	8775	9360	9945	10525	11120	11705	12290	12875	13240	13605	13965	14330
40 mph Dual	5620	6770	7905	8475	9050	9610	10185	10750	11310	11885	12445	12775	13120	13450	13780

Rim Size (inch)		Description										MSPN (CAI)			
42		VF 710/70 R42 182D/179E TL										01871 (523668)			
Section Width	Overall Diam. (in.)	Loaded Radius (in.)	Rolling Circum. (in.)	Recommended Rim	Acceptable Rims						Min. Dual / Triple Spacing (in.)	75% internal volume (gal.)	Tread depth (32nd in.)		
28.8	81.3	35.7	240.3	DW25B (A)	DW23B (A) MW25B (A)						35.8	229	79		
Psi	6	9	12	13	15	16	17	19	20	22	23	25	26	28	29
6 mph **		11695	13645	14615	15585	16570	17540	18520	19490	20470	21440	21935	22430	22930	23425
20 mph		10095	11785	12630	13470	14310	15155	15995	16830	17680	18520	18950	19380	19810	20240
40 mph		9360	10915	11695	12465	13250	14030	14815	15585	16370	17150	17550	17945	18340	18740
43 mph		8510	9930	10650	11355	12060	12775	13480	14185	14905	15610	15985	16345	16720	17085
40 mph Dual	6890	8255	9610	10295	10980	11660	12345	13040	13725	14405	15090	15445	15795	16140	16490

Rim Size (inch)		Description										MSPN (CAI)			
42		VF 710/75 R42 184D/180E TL										01608 (259635)			
Section Width	Overall Diam. (in.)	Loaded Radius (in.)	Rolling Circum. (in.)	Recommended Rim	Acceptable Rims						Min. Dual / Triple Spacing (in.)	75% internal volume (gal.)	Tread depth (32nd in.)		
29	84.8	37.4	250.8	DW25B (A)	DW23B (A)						35.8	249.6	82		
Psi	6	9	12	13	15	16	17	19	20	22	23	25	26	28	29
6 mph **		12445	14515	15555	16590	17625	18660	19700	20735	21770	22805	23305	23810	24305	24800
20 mph		10750	12545	13435	14330	15225	16115	17020	17915	18805	19700	20130	20570	21000	21430
40 mph		9955	11620	12445	13270	14100	14925	15765	16590	17415	18245	18640	19050	19445	19840
43 mph		9060	10570	11320	12070	12830	13580	14340	15090	15850	16600	16865	17120	17385	17635
40 mph Dual	7275	8740	10205	10945	11675	12400	13130	13865	14595	15320	16050	16400	16755	17110	17460

Rim Size (inch)		Description										MSPN (CAI)			
42		VF 900/60 R42 189D/185E TL										17679 (428922)			
Section Width	Overall Diam. (in.)	Loaded Radius (in.)	Rolling Circum. (in.)	Recommended Rim	Acceptable Rims						Min. Dual / Triple Spacing (in.)	75% internal volume (gal.)	Tread depth (32nd in.)		
34.7	85	37.1	250.3	DW30B (A)	DW28B (A) (NRO)						43.6	324.9	81		
Psi	6	9	12	13	15	16	17	19	20	22	23	25	26	28	29
6 mph **		13900	16215	17370	18530	19685	20845	22000	23160	24315	25475	26200	26930	27655	28385
20 mph		12005	14010	15000	16005	17010	18010	19015	20005	21010	22015	22640	23270	23900	24525
40 mph		11120	12975	13900	14825	15750	16680	17605	18530	19455	20380	20965	21550	22125	22710
43 mph		10120	11805	12655	13490	14340	15180	16030	16865	17715	18550	19015	19480	19930	20395
40 mph Dual	8080	9735	11385	12215	13040	13855	14670	15485	16305	17120	17935	18455	18960	19480	19985

* Refer to the notes at the end of the tables of this range

AXIOBIB® 2

Tire specifications and pressure table. Load per tire in lbs.*

Rim Size (inch)		Description							MSPN (CAI)						
44		VF 750/70 R44 186D/183E TL							85966 (681569)						
Section Width	Overall Diam. (in.)	Loaded Radius (in.)	Rolling Circum. (in.)	Recommended Rim	Acceptable Rims			Min. Dual / Triple Spacing (in.)	75% internal volume (gal.)	Tread depth (32nd in.)					
30	85.8	37.6	253.5	DW25B (A)	MW24B (A) MW25B (A) DW24B (A)			37.0	268.4	81					
Psi	6	9	12	13	15	16	17	19	20	22	23	25	26	28	29
6 mph **		12995	15170	16260	17340	18420	19500	20590	21670	22750	23830	24415	25010	25595	26180
20 mph		11235	13105	14045	14980	15915	16855	17790	18715	19655	20590	21100	21605	22110	22620
40 mph		10395	12135	12995	13865	14740	15600	16470	17340	18200	19070	19545	20005	20480	20945
43 mph		9460	11045	11830	12620	13415	14200	14990	15775	16570	17350	17835	18320	18805	19290
40 mph Dual	7520	9085	10635	11420	12205	12965	13725	14495	15255	16015	16775	17195	17605	18025	18430

*IMPORTANT:

The inflation pressure must always be appropriate for the load per tire, the speed of travel and the work to be done. Our recommendations above are provided subject to changes made after the date of publication of these tables. Technical data is subject to change without prior notice.

• For plowing and other field applications subject to high torque use the 20 mph line.

- When using single tire configuration:
 - add 6 psi for use on slopes of more than 20%
 - add 6 psi for intense road use exceeding 50%
- **6 mph LT (Low Torque) (max speed 6 mph).
- FRT: Free Rolling Tire



MULTIBIB™ / MULTIBIB™ PLUS

**VERSATILE 65 SERIES WIDE TIRE
WITH LONG SERVICE LIFE**

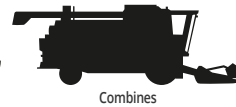

VERSATILITY

- Great performance in the field & on the road
- Fuel efficiency and wide contact patch for soil protection



PRODUCTIVITY

- Excellent traction to save time and fuel
- Capable of speeds of up to 40 mph¹
- Larger air chamber & footprint to carry heavier loads at lower pressures vs standard profile radials



LONG SERVICE LIFE

- Deepest tread depth vs. 4 main competitors²



COMFORT

- Excellent road handling and ride comfort



(1) When authorized by the laws in force in the country
(2) For 650/65 R42 size

SIZES

320/65 R16 107D TL

420/65 R24 126A8/126B TL

480/65 R28 136D TL

540/65 R38 147D TL

320/65 R18 109A8/106B TL

440/65 R24 128D TL

540/65 R28 142D TL

600/65 R38 153D TL

340/65R18 113D TL

480/65 R24 133D TL

540/65 R30 143D TL

650/65 R38 157D TL

420/65 R20 125A8/125B TL

540/65 R24 140D TL

540/65 R34 145D TL

650/65 R42 158D TL

440/65 R20 128D TL

420/65 R28 135D TL

540/65 R34 152D TL

650/65 R38 163D TL

420/65 R24 126D TL

440/65 R28 131D TL

600/65 R34 151D TL

650/65 R42 165D TL

MULTIBIB™

Tire specifications and pressure table. Load per tire in lbs.*

Rim Size (inch)		Description									MSPN (CAI)				
16		320/65 R16 107D TL									39517 (494658)				
Section Width	Overall Diam. (in.)	Loaded Radius (in.)	Rolling Circum. (in.)	Recommended Rim	Acceptable Rims						Min. Dual / Triple Spacing (in.)	75% internal volume (gal.)	Tread depth (32nd in.)		
11.8	32.6	14.5	96.5	W8	W10L / W8L / W9						17.1	17	37		
Psi	6	7	9	12	15	17	20	23	26	28	29	32	35	39	41
6 mph **	1145	1270	1390	1675	1960	2240	2525	2800	3075	3220					
20 mph	1145	1255	1365	1585	1810	2030	2260	2480							
25 mph		1170	1280	1500	1720	1930	2150	2360							
30 mph		1125	1225	1435	1640	1850	2060	2260							
40 mph		1080	1180	1380	1575	1765	1960	2150							

Rim Size (inch)		Description									MSPN (CAI)				
18		320/65 R18 109A8/106B TL XM108 [DISCONTINUED]									78520 (123898)				
Section Width	Overall Diam. (in.)	Loaded Radius (in.)	Rolling Circum. (in.)	Recommended Rim	Acceptable Rims						Min. Dual / Triple Spacing (in.)	75% internal volume (gal.)	Tread depth (32nd in.)		
12.2	34.4	15.3	102.1	W9	W10						17.1	16.8	35		
Psi	6	7	9	12	15	17	20	23	25	26	28				
6 mph **	880	1180	1475	1775	2070	2370	2670	2965	3120	3265	3415				
20 mph	860	1100	1345	1565	1775	1995	2205	2425							
25 mph		1015	1255	1465	1665	1875	2070	2270							
30 mph		950	1145	1335	1520	1720	1905	2095							

Rim Size (inch)		Description									MSPN (CAI)				
18		340/65R18 113D TL MULTIBIB									20099 (659984)				
Section Width	Overall Diam. (in.)	Loaded Radius (in.)	Rolling Circum. (in.)	Recommended Rim	Acceptable Rims						Min. Dual / Triple Spacing (in.)	75% internal volume (gal.)	Tread depth (32nd in.)		
13.3	35.7	15.7	105.7	W11	W10						18.2	21.2	37		
Psi	6	7	9	12	15	17	20	23	26	28	29	32	35	39	41
6 mph **	1435	1765	2095	2335	2570	2810	2975	3140	3470	3640	3805				
20 mph	1070	1335	1600	1930	2185	2425	2680	2920							
25 mph			1545	1820	2070	2315	2535	2755							
30 mph			1435	1765	1985	2205	2425	2645							
40 mph			1380	1655	1875	2095	2315	2535							

Rim Size (inch)		Description									MSPN (CAI)				
20		420/65 R20 125A8/125B TL XM108 [DISCONTINUED]									86582 (122702)				
Section Width	Overall Diam. (in.)	Loaded Radius (in.)	Rolling Circum. (in.)	Recommended Rim	Acceptable Rims						Min. Dual / Triple Spacing (in.)	75% internal volume (gal.)	Tread depth (32nd in.)		
15.6	41.9	18.1	123.4	W11	W10 W12						21.7	37	45		
Psi	6	7	9	12	15	17	20	23	25	26	28				
6 mph **	2140	2515	2890	3360	3825	4300	4760	5235	5465						
20 mph	1700	2040	2380	2765	3140	3525	3900								
25 mph		1830	2225	2580	2930	3285	3640								
30 mph		1830	2225	2460	2700	2930	3165	3405	3515	3640					

* Refer to the notes at the end of the tables of this range

MULTIBIB™

Tire specifications and pressure table. Load per tire in lbs.*

Rim Size (inch)		Description										MSPN (CAI)			
20		440/65 R20 128D TL										15810 (675464)			
Section Width	Overall Diam. (in.)	Loaded Radius (in.)	Rolling Circum. (in.)	Recommended Rim	Acceptable Rims						Min. Dual / Triple Spacing (in.)	75% internal volume (gal.)	Tread depth (32nd in.)		
17.5	42.9	18.7	128.3	W14L	W13 W15L						22.8	41.4	55		
Psi	6	7	9	12	15	17	20	23	26	28	29	32	35	39	41
6 mph **	2645	2855	3065	3460	3860	4255	4685	5105	5535	5745	5950				
20 mph	2030	2250	2470	2875	3275	3680	4125	4565							
25 mph			2360	2745	3120	3505	3925	4345							
30 mph			2260	2570	2890	3195	3680	4165							
40 mph			2150	2500	2845	3195	3585	3970							
25 mph Dual	1700	1885	2070	2415	2745	3085	3460	3825							

Rim Size (inch)		Description										MSPN (CAI)			
24		420/65 R24 126D TL										11709 (171560)			
Section Width	Overall Diam. (in.)	Loaded Radius (in.)	Rolling Circum. (in.)	Recommended Rim	Acceptable Rims						Min. Dual / Triple Spacing (in.)	75% internal volume (gal.)	Tread depth (32nd in.)		
15.4	45.5	20	134.5	W12	W11						21.7	42	48		
Psi	6	7	9	12	15	17	20	23	25	26	28	29	32	35	39
6 mph **	2645	2900	3140	3470	3805	4135	4465	4795	5215	5410	5620				
20 mph	2030	2225	2415	2845	3265	3680	4000	4310							
25 mph			2295	2700	3110	3505	3805	4100							
30 mph			2205	2590	2975	3360	3650	3935							
40 mph			2095	2470	2835	3195	3470	3750							

Rim Size (inch)		Description										MSPN (CAI)			
24		420/65 R24 126A8/126B TL XM108 [DISCONTINUED]										77842 (122712)			
Section Width	Overall Diam. (in.)	Loaded Radius (in.)	Rolling Circum. (in.)	Recommended Rim	Acceptable Rims						Min. Dual / Triple Spacing (in.)	75% internal volume (gal.)	Tread depth (32nd in.)		
15.6	45.7	20	134.8	W11	W10 W12						21.7	39.6	47		
Psi	6	7	9	12	15	17	20	23	25	26	28				
6 mph **	2185	2580	2975	3460	3935	4420	4905	5380	5620						
20 mph	1740	2095	2445	2845	3230	3625	4010								
25 mph		1875	2295	2655	3020	3385	3750								
30 mph		1875	2295	2535	2780	3020	3265	3505	3625	3750					

Rim Size (inch)		Description										MSPN (CAI)			
24		440/65 R24 128D TL										04039 (426389)			
Section Width	Overall Diam. (in.)	Loaded Radius (in.)	Rolling Circum. (in.)	Recommended Rim	Acceptable Rims						Min. Dual / Triple Spacing (in.)	75% internal volume (gal.)	Tread depth (32nd in.)		
17.3	46.7	20.8	138.5	DW14L	DW13 DW15L W13 W14L W15L						22.8	46.9	55		
Psi	6	7	9	12	15	17	20	23	26	28	29	32	35	39	41
6 mph **	2835	3020	3195	3650	4090	4540	4905	5280	5645	5820	6010				
20 mph	2160	2380	2600	3040	3485	3925	4245	4565							
25 mph			2490	2910	3330	3750	4045	4345							
30 mph			2380	2790	3185	3595	3880	4165							
40 mph			2270	2655	3030	3415	3695	3970							
25 mph Dual	1810	2005	2195	2555	2930	3295	3560	3825							

* Refer to the notes at the end of the tables of this range

MULTIBIB™

Tire specifications and pressure table. Load per tire in lbs.*

Rim Size (inch)		Description										MSPN (CAI)			
24		480/65 R24 133D TL										03176 (531721)			
Section Width	Overall Diam. (in.)	Loaded Radius (in.)	Rolling Circum. (in.)	Recommended Rim	Acceptable Rims						Min. Dual / Triple Spacing (in.)	75% internal volume (gal.)	Tread depth (32nd in.)		
19	48.8	21.5	144.4	DW15L	DW14L W14L W15L						24.6	57.6	58		
Psi	6	7	9	12	15	17	20	23	26	28	29	32	35	39	41
6 mph **	3195	3470	3750	4235	4720	5205	5645	6075	6515	6725	6945				
20 mph	2470	2735	3000	3470	3955	4430	4830	5225							
25 mph			2845	3305	3770	4235	4610	4980							
30 mph			2735	3175	3615	4055	4410	4760							
40 mph			2600	3020	3440	3860	4200	4540							
25 mph Dual	2070	2295	2500	2910	3320	3725	4055	4385							

Rim Size (inch)		Description										MSPN (CAI)			
24		540/65 R24 140D TL										08801 (097057)			
Section Width	Overall Diam. (in.)	Loaded Radius (in.)	Rolling Circum. (in.)	Recommended Rim	Acceptable Rims						Min. Dual / Triple Spacing (in.)	75% internal volume (gal.)	Tread depth (32nd in.)		
20.9	51.7	22.6	152.5	DW16L	DW18L W16L W18L						28.0	75.9	60		
Psi	6	7	9	12	15	17	20	23	26	28	29	32	35	39	41
6 mph **	3860	4135	4410	4995	5590	6175	6700	7220	7750	8005	8265				
20 mph	3000	3275	3550	4155	4775	5380	5865	6350							
25 mph			3375	3955	4530	5115	5580	6040							
30 mph			3240	3805	4355	4915	5355	5800							
40 mph			3085	3615	4145	4675	5095	5510							
25 mph Dual	2515	2745	2965	3470	3990	4495	4905	5315							

Rim Size (inch)		Description										MSPN (CAI)			
28		420/65 R28 135D TL [DISCONTINUED]										62700 (778211)			
Section Width	Overall Diam. (in.)	Loaded Radius (in.)	Rolling Circum. (in.)	Recommended Rim	Acceptable Rims						Min. Dual / Triple Spacing (in.)	75% internal volume (gal.)	Tread depth (32nd in.)		
15.4	48.7	22	144.9	W11	W12						21.7	46.7	55		
Psi	6	7	9	12	15	17	20	23	26	28	29	32	35	39	41
6 mph **	2810	3110	3405	3770	4135	4495	4815	5125	5500	5690	5875	6240	6615	7065	7210
20 mph	2160	2390	2610	2985	3385	3780	4165	4565	4805	4925	5050	5280	5525		
25 mph			2490	2845	3220	3595	3970	4345	4575	4685	4805	5025	5260		
30 mph			2270	2735	3095	3450	3805	4165	4385	4495	4610	4830	5050		
40 mph			2270	2600	2945	3285	3625	3970	4180	4290	4385	4595	4805		
25 mph Dual	1810	2005	2195	2555	2930	3295	3560	3825	4025	4125	4235	4430	4630	4915	5015

Rim Size (inch)		Description										MSPN (CAI)			
28		440/65 R28 131D TL										96372 (386212)			
Section Width	Overall Diam. (in.)	Loaded Radius (in.)	Rolling Circum. (in.)	Recommended Rim	Acceptable Rims						Min. Dual / Triple Spacing (in.)	75% internal volume (gal.)	Tread depth (32nd in.)		
17.2	50.8	22.8	150.9	DW14L	DW15L W13 W14L W15L						22.8	52.3	54		
Psi	6	7	9	12	15	17	20	23	26	28	29	32	35	39	41
6 mph **	3000	3265	3525	3955	4375	4805	5205	5600	5995	6195	6395				
20 mph	2335	2545	2755	3230	3715	4190	4565	4940							
25 mph			2625	3075	3540	3990	4355	4720							
30 mph			2515	2945	3385	3815	4165	4520							
40 mph			2405	2810	3230	3640	3970	4300							
25 mph Dual	1960	2140	2305	2710	3110	3515	3835	4155							

* Refer to the notes at the end of the tables of this range

MULTIBIB™

Tire specifications and pressure table. Load per tire in lbs.*

Rim Size (inch)		Description									MSPN (CAI)				
28		480/65 R28 136D TL									14369 (897574)				
Section Width	Overall Diam. (in.)	Loaded Radius (in.)	Rolling Circum. (in.)	Recommended Rim	Acceptable Rims					Min. Dual / Triple Spacing (in.)	75% internal volume (gal.)	Tread depth (32nd in.)			
18.7	52.7	23.5	156.3	DW15L	DW14L W14L W15L					24.6	63.8	57			
Psi	6	7	9	12	15	17	20	23	26	28	29	32	35	39	41
6 mph **	3415	3695	3970	4485	4995	5510	5985	6450	6925	7155	7385				
20 mph	2600	2890	3175	3725	4275	4830	5260	5690							
25 mph			3020	3540	4070	4585	4995	5400							
30 mph			2890	3395	3900	4410	4795	5180							
40 mph			2755	3230	3715	4190	4565	4940							
25 mph Dual	2185	2425	2655	3120	3570	4035	4400	4750							

Rim Size (inch)		Description									MSPN (CAI)				
28		540/65 R28 142D TL									36062 (792274)				
Section Width	Overall Diam. (in.)	Loaded Radius (in.)	Rolling Circum. (in.)	Recommended Rim	Acceptable Rims					Min. Dual / Triple Spacing (in.)	75% internal volume (gal.)	Tread depth (32nd in.)			
20.8	56.2	24.8	166.3	DW16L	DW18L W16L W18L					28.0	84	60			
Psi	6	7	9	12	15	17	20	23	26	28	29	32	35	39	41
6 mph **	4190	4495	4805	5410	6010	6615	7165	7715	8265	8545	8820				
20 mph	3175	3495	3815	4440	5060	5690	6205	6725							
25 mph			3615	4210	4805	5400	5895	6395							
30 mph			3485	4045	4620	5180	5655	6130							
40 mph			3305	3845	4400	4940	5390	5840							
25 mph Dual	2655	2920	3185	3705	4235	4750	5190	5620							

Rim Size (inch)		Description									MSPN (CAI)				
30		540/65 R30 143D TL									28553 (223153)				
Section Width	Overall Diam. (in.)	Loaded Radius (in.)	Rolling Circum. (in.)	Recommended Rim	Acceptable Rims					Min. Dual / Triple Spacing (in.)	75% internal volume (gal.)	Tread depth (32nd in.)			
20.7	58	25.5	171.4	DW16L	DW18L W16L W18L					28.0	88	60			
Psi	6	7	9	12	15	17	20	23	26	28	29	32	35	39	41
6 mph **	4300	4620	4940	5555	6160	6780	7365	7935	8520	8805	9095				
20 mph	3265	3595	3925	4565	5205	5840	6370	6900							
25 mph			3750	4355	4950	5555	6065	6570							
30 mph			3595	4180	4750	5335	5820	6305							
40 mph			3415	3970	4520	5070	5545	6010							
25 mph Dual	2735	3020	3295	3825	4365	4895	5335	5775							

Rim Size (inch)		Description									MSPN (CAI)				
34		540/65 R34 152D TL [DISCONTINUED]									99445 (214036)				
Section Width	Overall Diam. (in.)	Loaded Radius (in.)	Rolling Circum. (in.)	Recommended Rim	Acceptable Rims					Min. Dual / Triple Spacing (in.)	75% internal volume (gal.)	Tread depth (32nd in.)			
20.9	62.6	27.9	185.7	DW16L	DW18L W16L W18L					28.0	96.1	60			
Psi	6	7	9	12	15	17	20	23	26	28	29	32	35	39	41
6 mph **	4540	4870	5205	5855	6515	7165	7780	8410	9030	9335	9645	10195	10750	11495	11740
20 mph	3440	3815	4190	4905	5635	6350	6855	7365	7770	7980	8180	8585	8995		
25 mph			3990	4675	5355	6040	6525	7010	7410	7595	7795	8190	8575		
30 mph			3815	4475	5135	5800	6260	6725	7100	7285	7475	7850	8225		
40 mph			3640	4265	4885	5510	5950	6395	6755	6935	7110	7475	7825		
25 mph Dual	2890	3210	3515	4110	4720	5315	5745	6175	6515	6690	6855	7200	7540		

* Refer to the notes at the end of the tables of this range

MULTIBIB™

Tire specifications and pressure table. Load per tire in lbs.*

Rim Size (inch)		Description									MSPN (CAI)				
34		540/65 R34 145D TL									22243 (712064)				
Section Width	Overall Diam. (in.)	Loaded Radius (in.)	Rolling Circum. (in.)	Recommended Rim	Acceptable Rims					Min. Dual / Triple Spacing (in.)	75% internal volume (gal.)	Tread depth (32nd in.)			
20.9	62	27.3	183.3	DW16L	DW18L W16L W18L					28.0	96.1	60			
Psi	6	7	9	12	15	17	20	23	26	28	29	32	35	39	41
6 mph **	4540	4870	5205	5855	6515	7165	7780	8410	9030	9335	9645				
20 mph	3440	3815	4190	4905	5635	6350	6855	7365							
25 mph			3990	4675	5355	6040	6525 7010								
30 mph			3815	4475	5135	5800	6260 6725								
40 mph			3640	4265	4885	5510	5950 6395								
25 mph Dual	2890	3210	3515	4110	4720	5315	5745 6175								

Rim Size (inch)		Description									MSPN (CAI)				
34		600/65 R34 151D TL									16291 (557189)				
Section Width	Overall Diam. (in.)	Loaded Radius (in.)	Rolling Circum. (in.)	Recommended Rim	Acceptable Rims					Min. Dual / Triple Spacing (in.)	75% internal volume (gal.)	Tread depth (32nd in.)			
23.4	65.1	28.8	192.8	DW20B (A)	DW18L W18L					29.9	122.4	68			
Psi	6	7	9	12	15	17	20	23	26	28	29	32	35	39	41
6 mph **	5355	5765	6175	6965	7750	8545	9250	9955	10650	11000	11355				
20 mph	4055	4495	4940	5745	6560	7365	8060	8750							
25 mph			4720	5480	6250	7010	7670	8335							
30 mph			4520	5260	5985	6725	7350	7980							
40 mph			4300	4995	5700	6395	7000	7605							
25 mph Dual	3395	3780	4155	4830	5500	6175	6755	7330							

Rim Size (inch)		Description									MSPN (CAI)				
38		540/65 R38 147D TL									28857 (114518)				
Section Width	Overall Diam. (in.)	Loaded Radius (in.)	Rolling Circum. (in.)	Recommended Rim	Acceptable Rims					Min. Dual / Triple Spacing (in.)	75% internal volume (gal.)	Tread depth (32nd in.)			
20.8	65.9	29.3	195.5	DW16L	DW18L W16L W18L					28.0	104	60			
Psi	6	7	9	12	15	17	20	23	26	28	29	32	35	39	41
6 mph **	4805	5160	5510	6205	6910	7605	8255	8905	9545	9875	10195				
20 mph	3680	4055	4430	5125	5830	6525	7165	7805							
25 mph			4235	4895	5555	6215	6825	7430							
30 mph			4055	4685	5325	5950	6535	7120							
40 mph			3860	4465	5070	5675	6230	6780							
25 mph Dual	3085	3405	3725	4310	4885	5465	6010	6535							

Rim Size (inch)		Description									MSPN (CAI)				
38		600/65 R38 153D TL									29767 (228045)				
Section Width	Overall Diam. (in.)	Loaded Radius (in.)	Rolling Circum. (in.)	Recommended Rim	Acceptable Rims					Min. Dual / Triple Spacing (in.)	75% internal volume (gal.)	Tread depth (32nd in.)			
23.4	69.6	30.7	205.9	DW20B (A)	DW18L W18L					29.9	132.1	67			
Psi	6	7	9	12	15	17	20	23	26	28	29	32	35	39	41
6 mph **	5675	6120	6550	7395	8245	9095	9820	10560	11290	11650	12015				
20 mph	4320	4775	5225	6085	6945	7805	8530	9260							
25 mph			4980	5800	6615	7430	8125	8820							
30 mph			4760	5545	6340	7120	7780	8445							
40 mph			4540	5290	6030	6780	7420	8045							
25 mph Dual	3625	4010	4385	5105	5820	6535	7155	7760							

* Refer to the notes at the end of the tables of this range

MULTIBIB™

Tire specifications and pressure table. Load per tire in lbs.*

Rim Size (inch)		Description									MSPN (CAI)				
38		650/65 R38 157D TL									12871 (292904)				
Section Width	Overall Diam. (in.)	Loaded Radius (in.)	Rolling Circum. (in.)	Recommended Rim	Acceptable Rims					Min. Dual / Triple Spacing (in.)	75% internal volume (gal.)	Tread depth (32nd in.)			
25.4	71.6	31.5	211.8	DW20B (A)							32.5	159.1	71		
Psi	6	7	9	12	15	17	20	23	26	28	29	32	35	39	41
6 mph **	6395	6890	7385	8320	9260	10195	11035	11885	12720	13140	13560				
20 mph	4830	5335	5840	6810	7780	8750	9600	10450							
25 mph			5555	6480	7410	8335	9150	9965							
30 mph			5335	6215	7100	7980	8765	9545							
40 mph			5070	5920	6755	7605	8355	9095							
25 mph Dual	4045	4475	4895	5710	6515	7330	8060	8775							

Rim Size (inch)		Description									MSPN (CAI)				
42		650/65 R42 158D TL									38881 (167733)				
Section Width	Overall Diam. (in.)	Loaded Radius (in.)	Rolling Circum. (in.)	Recommended Rim	Acceptable Rims					Min. Dual / Triple Spacing (in.)	75% internal volume (gal.)	Tread depth (32nd in.)			
25.1	76	33.8	225.3	DW20B (A)							32.5	170.8	72		
Psi	6	7	9	12	15	17	20	23	26	28	29	32	35	39	41
6 mph **	6615	7110	7605	8565	9515	10470	11365	12270	13160	13605	14055				
20 mph	5070	5610	6150	7185	8225	9260	10020	10780							
25 mph			5865	6845	7835	8820	9535	10250							
30 mph			5620	6560	7505	8445	9140	9835							
40 mph			5355	6250	7155	8045	8710	9370							
25 mph Dual	4255	4705	5160	6030	6890	7760	8390	9015							

* Refer to the notes at the end of the tables of this range

MULTIBIB™ PLUS

Tire specifications and pressure table. Load per tire in lbs.*

Rim Size (inch)		Description										MSPN (CAI)			
38		650/65 R38 163D TL MULTIBIB PLUS										41949 (476461)			
Section Width	Overall Diam. (in.)	Loaded Radius (in.)	Rolling Circum. (in.)	Recommended Rim	Acceptable Rims						Min. Dual / Triple Spacing (in.)	75% internal volume (gal.)	Tread depth (32nd in.)		
26.1	72	32.2	213.6	DW20B (A)							32.5	159.5	71		
Psi	6	7	9	12	15	17	20	23	26	28	29	32	35	39	41
6 mph **	6395	6880	7365	8320	9260	10195	11045	11885	12720	13140	13560	13975	14395		
20 mph	4830	5325	5820	6810	7780	8750	9600	10450	11000	11265	11540	11960	12370		
25 mph				6480	7410	8335	9150	9965	10485	10735	10990	11385	11775		
30 mph				6215	7100	7980	8765	9545	10040	10295	10540	10915	11290		
40 mph				5930	6770	7605	8355	9095	9570	9800	10030	10395	10750		
25 mph Dual	4045	4465	4885	5710	6525	7330	8060	8775	9225	9445	9665	10020	10360		

Rim Size (inch)		Description										MSPN (CAI)			
42		650/65 R42 165D TL MULTIBIB PLUS										37632 (512785)			
Section Width	Overall Diam. (in.)	Loaded Radius (in.)	Rolling Circum. (in.)	Recommended Rim	Acceptable Rims						Min. Dual / Triple Spacing (in.)	75% internal volume (gal.)	Tread depth (32nd in.)		
25.1	76.2	34.2	226.5	DW20B (A)							32.5	169.7	72		
Psi	6	7	9	12	15	17	20	23	26	28	29	32	35	39	41
6 mph **	6615	7100	7595	8565	9525	10470	11375	12270	13160	13615	14055	14880	15710		
20 mph	5115	5635	6150	7185	8225	9260	10075	10890	11475	11760	12050	12555	13060		
25 mph				6845	7835	8820	9600	10375	10925	11190	11465	11950	12435		
30 mph				6560	7505	8445	9195	9945	10470	10735	11000	11465	11925		
40 mph				6250	7155	8045	8765	9470	9975	10220	10470	10915	11355		
25 mph Dual	4255	4695	5150	6030	6900	7760	8390	9015	9500	9745	9985	10450	10915		

*IMPORTANT:

The inflation pressure must always be appropriate for the load per tire, the speed of travel and the work to be done. Our recommendations above are provided subject to changes made after the date of publication of these tables. Technical data is subject to change without prior notice.

• For plowing and other field applications subject to high torque use the 20 mph line.

- When using single tire configuration:
 - add 6 psi for use on slopes of more than 20%
 - add 6 psi for intense road use exceeding 50%
- **6 mph LT (Low Torque) (max speed 6 mph).
- FRT: Free Rolling Tire



OMNIBIB™

LOW PROFILE 70 SERIES TIRE



VERSATILITY

- Specially designed to withstand the stresses of front loaders
- Up to 14%¹ more load capacity vs equivalent standard radial sizes
- D speed rating



TRACTION AND HANDLING

- Excellent stability & maneuverability for work with livestock
- Super traction capacity



SERVICE LIFE

- Proven casing endurance
- Damage resistant



SOIL PROTECTION

- Wide contact patch for low soil compaction



(1) Depending on tire sizes & compared with the equivalent size in MICHELIN AGRIBIB

SIZES

280/70 R16 112D TL

280/70 R20 116D TL

320/70 R24 116D TL

360/70 R24 122D TL

380/70 R24 125D TL

420/70 R24 130D TL

480/70 R24 138D TL

380/70 R28 127D TL

420/70 R28 133D TL

480/70 R28 140D TL

480/70 R30 141D TL

480/70 R34 143D TL

520/70 R34 148D TL

480/70 R38 145D TL

520/70 R38 150D TL

580/70 R38 155D TL

620/70 R42 160D TL

OMNIBIB™

Tire specifications and pressure table. Load per tire in lbs.*

Rim Size (inch)		Description										MSPN (CAI)			
16		280/70 R16 112D TL										37920 (747196)			
Section Width	Overall Diam. (in.)	Loaded Radius (in.)	Rolling Circum. (in.)	Recommended Rim	Acceptable Rims						Min. Dual / Triple Spacing (in.)	75% internal volume (gal.)	Tread depth (32nd in.)		
10.9	31.7	14.2	94.5	W9	W10L W8 W8L						15.3	11.9	37		
Psi	6	7	9	12	15	17	20	23	26	28	29	32	35	39	41
6 mph **	1280	1380	1465	1665	1850	2050	2240	2425	2625	2710	2810	3030	3265	3595	3705
20 mph	980	1080	1180	1380	1575	1765	1960	2160	2335	2415	2500	2680	2845		
25 mph			1115	1300	1490	1675	1865	2050	2215	2295	2380	2535	2700		
30 mph			1070	1245	1435	1610	1795	1975	2125	2205	2280	2435	2590		
40 mph			1015	1190	1355	1530	1700	1875	2030	2095	2170	2325	2470		
25 mph Dual	825	905	980	1145	1310	1475	1640	1810	1950	2030	2095	2240	2380		

Rim Size (inch)		Description										MSPN (CAI)			
20		280/70 R20 116D TL										30655 (263806)			
Section Width	Overall Diam. (in.)	Loaded Radius (in.)	Rolling Circum. (in.)	Recommended Rim	Acceptable Rims						Min. Dual / Triple Spacing (in.)	75% internal volume (gal.)	Tread depth (32nd in.)		
10.6	35.6	16.1	105.9	W9	W10 W8						15.3	16	37		
Psi	6	7	9	12	15	17	20	23	26	28	29	32	35	39	41
6 mph **	1410	1520	1630	1840	2060	2280	2490	2710	2920	3030	3140	3395	3640	4010	4135
20 mph	1080	1190	1300	1520	1755	1975	2195	2415	2600	2700	2800	2985	3175		
25 mph			1245	1455	1665	1875	2085	2295	2480	2570	2655	2845	3020		
30 mph			1190	1390	1600	1795	2005	2205	2380	2470	2555	2725	2900		
40 mph			1135	1325	1520	1710	1905	2095	2260	2350	2425	2590	2755		

Rim Size (inch)		Description										MSPN (CAI)			
24		320/70 R24 116D TL										25416 (415039)			
Section Width	Overall Diam. (in.)	Loaded Radius (in.)	Rolling Circum. (in.)	Recommended Rim	Acceptable Rims						Min. Dual / Triple Spacing (in.)	75% internal volume (gal.)	Tread depth (32nd in.)		
12.7	43.3	19.6	128.9	W10	W11 W9						17.1	24.8	51		
Psi	6	7	9	12	15	17	20	23	26	28	29	32	35	39	41
6 mph **	1920	2060	2195	2480	2755	3030	3305	3595	3870	4000	4145				
20 mph	1475	1620	1765	2040	2325	2610	2890	3175							
25 mph			1675	1940	2215	2480	2755	3020							
30 mph			1585	1850	2105	2370	2625	2890							
40 mph			1520	1765	2015	2260	2515	2755							
25 mph Dual	1235	1355	1475	1710	1950	2185	2425	2655							

Rim Size (inch)		Description										MSPN (CAI)			
24		360/70 R24 122D TL										45416 (198698)			
Section Width	Overall Diam. (in.)	Loaded Radius (in.)	Rolling Circum. (in.)	Recommended Rim	Acceptable Rims						Min. Dual / Triple Spacing (in.)	75% internal volume (gal.)	Tread depth (32nd in.)		
14.7	45.4	20.2	134.6	W11	W10 W12L						18.9	36.1	55		
Psi	6	7	9	12	15	17	20	23	26	28	29	32	35	39	41
6 mph **	2295	2460	2625	2965	3295	3625	3955	4300	4630	4795	4960				
20 mph	1740	1920	2085	2435	2780	3120	3470	3815							
25 mph			1985	2315	2635	2965	3285	3615							
30 mph			1920	2225	2545	2855	3175	3485							
40 mph			1820	2115	2415	2710	3010	3305							
25 mph Dual	1465	1610	1755	2040	2325	2610	2900	3185							

* Refer to the notes at the end of the tables of this range

OMNIBIB™

Tire specifications and pressure table. Load per tire in lbs.*

Rim Size (inch)		Description									MSPN (CAI)				
24		380/70 R24 125D TL									64778 (085816)				
Section Width	Overall Diam. (in.)	Loaded Radius (in.)	Rolling Circum. (in.)	Recommended Rim	Acceptable Rims					Min. Dual / Triple Spacing (in.)	75% internal volume (gal.)	Tread depth (32nd in.)			
15.7	46.8	20.8	138.6	W12	W11 W13					20.0	42.4	56			
Psi	6	7	9	12	15	17	20	23	26	28	29	32	35	39	41
6 mph **	2490	2680	2865	3240	3605	3980	4355	4730	5095	5280	5465				
20 mph	1895	2085	2280	2655	3040	3430	3805	4190							
25 mph			2185	2545	2910	3265	3625	3990							
30 mph			2095	2435	2780	3130	3470	3815							
40 mph			1985	2315	2645	2975	3305	3640							
25 mph Dual	1600	1755	1905	2225	2545	2865	3185	3505							

Rim Size (inch)		Description									MSPN (CAI)				
24		420/70 R24 130D TL									28067 (829095)				
Section Width	Overall Diam. (in.)	Loaded Radius (in.)	Rolling Circum. (in.)	Recommended Rim	Acceptable Rims					Min. Dual / Triple Spacing (in.)	75% internal volume (gal.)	Tread depth (32nd in.)			
17.2	49.3	21.8	145.7	W13	DW14L W12L W14L					21.7	53.7	58			
Psi	6	7	9	12	15	17	20	23	26	28	29	32	35	39	41
6 mph **	2890	3095	3320	3735	4165	4585	5015	5435	5865	6075	6285				
20 mph	2225	2445	2655	3095	3525	3955	4400	4830							
25 mph			2490	2910	3330	3750	4165	4585							
30 mph			2380	2790	3195	3595	4000	4410							
40 mph			2270	2655	3040	3415	3805	4190							
25 mph Dual	1865	2030	2195	2555	2930	3295	3670	4035							

Rim Size (inch)		Description									MSPN (CAI)				
24		480/70 R24 138D TL									02475 (375821)				
Section Width	Overall Diam. (in.)	Loaded Radius (in.)	Rolling Circum. (in.)	Recommended Rim	Acceptable Rims					Min. Dual / Triple Spacing (in.)	75% internal volume (gal.)	Tread depth (32nd in.)			
19.4	52.2	22.8	154.2	DW15L	DW14L DW16L W14L W15L W16L					24.6	72.9	61			
Psi	6	7	9	12	15	17	20	23	26	28	29	32	35	39	41
6 mph **	3505	3770	4045	4585	5115	5655	6195	6735	7265	7540	7805				
20 mph	2690	2965	3240	3780	4330	4885	5425	5975							
25 mph			3110	3625	4145	4650	5170	5690							
30 mph			2975	3470	3970	4475	4970	5465							
40 mph			2835	3305	3780	4255	4730	5205							
25 mph Dual	2250	2490	2735	3185	3650	4100	4565	5015							

Rim Size (inch)		Description									MSPN (CAI)				
28		380/70 R28 127D TL									24723 (118587)				
Section Width	Overall Diam. (in.)	Loaded Radius (in.)	Rolling Circum. (in.)	Recommended Rim	Acceptable Rims					Min. Dual / Triple Spacing (in.)	75% internal volume (gal.)	Tread depth (32nd in.)			
15.4	50.9	22.8	151.3	W12	W11 W13					20.0	47.3	56			
Psi	6	7	9	12	15	17	20	23	26	28	29	32	35	39	41
6 mph **	2645	2845	3040	3440	3825	4220	4620	5015	5400	5600	5800				
20 mph	2030	2225	2425	2835	3230	3625	4035	4430							
25 mph			2295	2680	3065	3460	3845	4235							
30 mph			2205	2580	2945	3320	3680	4055							
40 mph			2095	2445	2800	3155	3505	3860							
25 mph Dual	1700	1865	2015	2360	2700	3030	3375	3715							

* Refer to the notes at the end of the tables of this range

OMNIBIB™

Tire specifications and pressure table. Load per tire in lbs.*

Rim Size (inch)		Description									MSPN (CAI)				
28		420/70 R28 133D TL									25705 (532215)				
Section Width	Overall Diam. (in.)	Loaded Radius (in.)	Rolling Circum. (in.)	Recommended Rim	Acceptable Rims					Min. Dual / Triple Spacing (in.)	75% internal volume (gal.)	Tread depth (32nd in.)			
17.2	53.3	23.7	158	W13	DW14L W12 W14L					21.7	61	58			
Psi	6	7	9	12	15	17	20	23	26	28	29	32	35	39	41
6 mph **	3065	3295	3540	4000	4475	4940	5410	5875	6350	6580	6810				
20 mph	2335	2580	2820	3295	3780	4265	4740	5225							
25 mph			2710	3165	3615	4080	4530	4980							
30 mph			2600	3030	3460	3900	4330	4760							
40 mph			2470	2890	3295	3715	4125	4540							
25 mph Dual	1960	2170	2380	2780	3175	3585	3980	4375							

Rim Size (inch)		Description									MSPN (CAI)				
28		480/70 R28 140D TL									27084 (570026)				
Section Width	Overall Diam. (in.)	Loaded Radius (in.)	Rolling Circum. (in.)	Recommended Rim	Acceptable Rims					Min. Dual / Triple Spacing (in.)	75% internal volume (gal.)	Tread depth (32nd in.)			
19.7	56.2	24.9	166	DW15L	DW14L DW16L W14L W15L W16L					24.6	79.6	61			
Psi	6	7	9	12	15	17	20	23	26	28	29	32	35	39	41
6 mph **	3815	4090	4375	4925	5490	6040	6605	7155	7715	7990	8265				
20 mph	2910	3195	3485	4055	4630	5205	5775	6350							
25 mph			3285	3835	4385	4940	5490	6040							
30 mph			3155	3680	4210	4740	5270	5800							
40 mph			3000	3505	4000	4510	5005	5510							
25 mph Dual	2445	2670	2890	3375	3860	4345	4830	5315							

Rim Size (inch)		Description									MSPN (CAI)				
30		480/70 R30 141D TL									27236 (599351)				
Section Width	Overall Diam. (in.)	Loaded Radius (in.)	Rolling Circum. (in.)	Recommended Rim	Acceptable Rims					Min. Dual / Triple Spacing (in.)	75% internal volume (gal.)	Tread depth (32nd in.)			
19.6	58.3	25.8	172.8	DW15L	DW14L DW16L W14L W15L W16L					24.6	83.6	61			
Psi	6	7	9	12	15	17	20	23	26	28	29	32	35	39	41
6 mph **	3900	4190	4475	5060	5635	6205	6780	7365	7935	8225	8510				
20 mph	3000	3295	3585	4180	4760	5345	5940	6525							
25 mph			3375	3945	4510	5080	5645	6215							
30 mph			3240	3780	4320	4870	5410	5950							
40 mph			3085	3605	4125	4640	5160	5675							
25 mph Dual	2500	2745	2975	3470	3970	4475	4970	5465							

Rim Size (inch)		Description									MSPN (CAI)				
34		480/70 R34 143D TL									25021 (280033)				
Section Width	Overall Diam. (in.)	Loaded Radius (in.)	Rolling Circum. (in.)	Recommended Rim	Acceptable Rims					Min. Dual / Triple Spacing (in.)	75% internal volume (gal.)	Tread depth (32nd in.)			
19.6	62.7	28.1	186.1	DW15L	DW14L DW16L W14L W15L W16L					24.6	91.1	65			
Psi	6	7	9	12	15	17	20	23	26	28	29	32	35	39	41
6 mph **	4145	4455	4750	5370	5975	6580	7185	7805	8410	8710	9015				
20 mph	3175	3485	3790	4420	5040	5655	6285	6900							
25 mph			3615	4210	4795	5390	5975	6570							
30 mph			3485	4045	4610	5180	5745	6305							
40 mph			3305	3845	4385	4925	5465	6010							
25 mph Dual	2655	2920	3185	3705	4220	4750	5270	5785							

* Refer to the notes at the end of the tables of this range

OMNIBIB™

Tire specifications and pressure table. Load per tire in lbs.*

Rim Size (inch)		Description									MSPN (CAI)				
34		520/70 R34 148D TL									29601 (939411)				
Section Width	Overall Diam. (in.)	Loaded Radius (in.)	Rolling Circum. (in.)	Recommended Rim	Acceptable Rims					Min. Dual / Triple Spacing (in.)	75% internal volume (gal.)	Tread depth (32nd in.)			
21.1	65	28.7	192.4	DW16L	DW15L DW18L W15L W16L W18L						26.6	111.3	67		
Psi	6	7	9	12	15	17	20	23	26	28	29	32	35	39	41
6 mph **	4630	4995	5355	6085	6800	7530	8255	8985	9700	10065	10430				
20 mph	3550	3925	4290	5025	5765	6505	7240	7980							
25 mph			4100	4805	5500	6205	6900	7605							
30 mph			3945	4620	5290	5950	6625	7295							
40 mph			3750	4385	5025	5665	6305	6945							
25 mph Dual	2975	3295	3615	4235	4850	5455	6075	6690							

Rim Size (inch)		Description									MSPN (CAI)				
38		480/70 R38 145D TL									28503 (936570)				
Section Width	Overall Diam. (in.)	Loaded Radius (in.)	Rolling Circum. (in.)	Recommended Rim	Acceptable Rims					Min. Dual / Triple Spacing (in.)	75% internal volume (gal.)	Tread depth (32nd in.)			
19.6	66.7	29.9	198	DW15L	DW14L DW16L W14L W15L W16L						24.6	99.6	67		
Psi	6	7	9	12	15	17	20	23	26	28	29	32	35	39	41
6 mph **	4365	4695	5015	5675	6325	6980	7630	8290	8940	9260	9590				
20 mph	3350	3680	4025	4685	5355	6030	6690	7365							
25 mph			3860	4485	5115	5755	6380	7010							
30 mph			3705	4310	4915	5510	6120	6725							
40 mph			3525	4100	4675	5245	5820	6395							
25 mph Dual	2800	3095	3395	3945	4495	5060	5610	6160							

Rim Size (inch)		Description									MSPN (CAI)				
38		520/70 R38 150D TL									28089 (833744)				
Section Width	Overall Diam. (in.)	Loaded Radius (in.)	Rolling Circum. (in.)	Recommended Rim	Acceptable Rims					Min. Dual / Triple Spacing (in.)	75% internal volume (gal.)	Tread depth (32nd in.)			
21.2	69.5	30.8	205.9	DW16L	DW15L DW18L W15L W16L W18L						26.4	122.4	67		
Psi	6	7	9	12	15	17	20	23	26	28	29	32	35	39	41
6 mph **	4960	5345	5730	6495	7265	8025	8795	9555	10330	10705	11090				
20 mph	3815	4200	4595	5370	6150	6935	7705	8490							
25 mph			4345	5095	5840	6590	7340	8090							
30 mph			4165	4885	5600	6325	7045	7760							
40 mph			3970	4650	5335	6020	6700	7385							
25 mph Dual	3185	3505	3825	4485	5150	5800	6460	7120							

Rim Size (inch)		Description									MSPN (CAI)				
38		580/70 R38 155D TL									31198 (001240)				
Section Width	Overall Diam. (in.)	Loaded Radius (in.)	Rolling Circum. (in.)	Recommended Rim	Acceptable Rims					Min. Dual / Triple Spacing (in.)	75% internal volume (gal.)	Tread depth (32nd in.)			
23.7	72.3	32.1	214.2	DW18L	W18L					29.3	155.7	72			
Psi	6	7	9	12	15	17	20	23	26	28	29	32	35	39	41
6 mph **	5800	6240	6680	7550	8435	9305	10185	11055	11940	12370	12810				
20 mph	4430	4885	5335	6230	7130	8035	8930	9835							
25 mph			5115	5965	6810	7650	8500	9350							
30 mph			4915	5730	6535	7350	8155	8975							
40 mph			4675	5445	6215	7000	7770	8545							
25 mph Dual	3715	4110	4510	5260	5995	6745	7485	8235							

* Refer to the notes at the end of the tables of this range

OMNIBIB™

Tire specifications and pressure table. Load per tire in lbs.*

Rim Size (inch)		Description										MSPN (CAI)			
42		620/70 R42 160D TL										31015 (989457)			
Section Width	Overall Diam. (in.)	Loaded Radius (in.)	Rolling Circum. (in.)	Recommended Rim	Acceptable Rims					Min. Dual / Triple Spacing (in.)	75% internal volume (gal.)	Tread depth (32nd in.)			
25.2	76.9	34	227.6	DW20B (A)	DW18L					31.5	173.7	74			
Psi	6	7	9	12	15	17	20	23	26	28	29	32	35	39	41
6 mph **	6810	7320	7825	8830	9845	10845	11860	12865	13880	14375	14880				
20 mph	5225	5745	6260	7285	8320	9360	10385	11420							
25 mph			5865	6865	7870	8865	9865	10870							
30 mph			5620	6580	7540	8510	9470	10430							
40 mph			5355	6270	7185	8090	9005	9920							
25 mph Dual	4375	4775	5160	6040	6925	7795	8675	9555							

***IMPORTANT:**

The inflation pressure must always be appropriate for the load per tire, the speed of travel and the work to be done. Our recommendations above are provided subject to changes made after the date of publication of these tables. Technical data is subject to change without prior notice.

• For plowing and other field applications subject to high torque use the 20 mph line.

- When using single tire configuration:
 - add 6 psi for use on slopes of more than 20%
 - add 6 psi for intense road use exceeding 50%
- **6 mph LT (Low Torque) (max speed 6 mph).
- FRT: Free Rolling Tire



XEOBIB™

**LOW PRESSURE R1W RADIAL;
FIRST VF TIRE IN THE INDUSTRY**



RETURN ON INVESTMENT

- Proven yield gains of +4% using Ultraflex tires¹
- Designed for a long service life



FUEL SAVINGS

- Save up to 15% when working in the field²



COMFORT

- Absorbs shocks & surface irregularities



HIGH LOAD CAPACITY

- 40% more load capacity compared to standard tires of the same size, at the same pressure

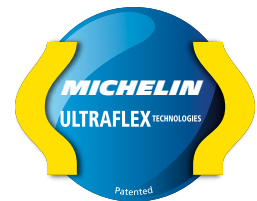

VF Very High Flexion



(1) Harper Adams University 2014/2016

(2) Average observed compared with a standard size in field tests

SIZES

VF 480/60 R28 134D TL

VF 520/60 R28 138D TL

VF 600/60 R28 146D TL

VF 600/60 R30 147D TL

VF 600/60 R34 149D TL

VF 600/60 R38 151D TL

VF 650/60 R38 155D TL

VF 710/60 R38 160D TL

VF 650/60 R42 157D TL

VF 710/60 R42 161D TL

XEOBIB™

Tire specifications and pressure table. Load per tire in lbs.*

Rim Size (inch)		Description						MSPN (CAI)		
28		VF 480/60 R28 134D TL						80140 (312875)		
Section Width	Overall Diam. (in.)	Loaded Radius (in.)	Rolling Circum. (in.)	Recommended Rim	Acceptable Rims			Min. Dual / Triple Spacing (in.)	75% internal volume (gal.)	Tread depth (32nd in.)
19.2	51.1	22.3	150.8	DW16L	W16L			25.2	57.6	56
Psi	6	7	9	10	12	13	15	26		
6 mph **	3195	3540	3880	4190	4485	4815	5135			
20 mph	2965	3285	3595	3880	4155	4465	4760			
40 mph	2910	3220	3525	3805	4080	4375	4675			
40 mph Dual	2555	2835	3110	3350	3595	3860	4110			
6 mph Fr Load								6615		

Rim Size (inch)		Description						MSPN (CAI)		
28		VF 520/60 R28 138D TL						80236 (510495)		
Section Width	Overall Diam. (in.)	Loaded Radius (in.)	Rolling Circum. (in.)	Recommended Rim	Acceptable Rims			Min. Dual / Triple Spacing (in.)	75% internal volume (gal.)	Tread depth (32nd in.)
21	52.7	22.8	155.2	DW18L	W18L			26.4	68.7	58
Psi	6	7	9	10	12	13	15	26		
6 mph **	3640	4000	4365	4685	4995	5355	5720			
20 mph	3375	3715	4045	4345	4630	4970	5300			
40 mph	3305	3640	3970	4255	4540	4870	5205			
40 mph Dual	2910	3210	3495	3750	4000	4290	4575			
6 mph Fr Load								7385		

Rim Size (inch)		Description						MSPN (CAI)		
28		VF 600/60 R28 146D TL						80297 (665184)		
Section Width	Overall Diam. (in.)	Loaded Radius (in.)	Rolling Circum. (in.)	Recommended Rim	Acceptable Rims			Min. Dual / Triple Spacing (in.)	75% internal volume (gal.)	Tread depth (32nd in.)
24	56.3	24	165.3	DW20B (A)				30.2	96.5	60
Psi	6	7	9	10	12	13	15	26		
6 mph **	4485	4960	5435	5930	6425	6855	7275			
20 mph	4155	4595	5040	5500	5965	6360	6745			
40 mph	4080	4510	4940	5390	5840	6230	6615			
40 mph Dual	3595	3970	4345	4740	5135	5480	5820			
6 mph Fr Load								9370		

Rim Size (inch)		Description						MSPN (CAI)		
30		VF 600/60 R30 147D TL						03690 (065253)		
Section Width	Overall Diam. (in.)	Loaded Radius (in.)	Rolling Circum. (in.)	Recommended Rim	Acceptable Rims			Min. Dual / Triple Spacing (in.)	75% internal volume (gal.)	Tread depth (32nd in.)
24.2	58.8	24.9	172.4	DW20B (A)				30.2	101	61
Psi	6	7	9	10	12	13	15	26		
6 mph **	4730	5160	5580	6095	6615	7045	7465			
20 mph	4385	4785	5170	5655	6130	6525	6910			
40 mph	4300	4685	5070	5545	6010	6395	6780			
40 mph Dual	3780	4125	4465	4885	5290	5635	5965			
6 mph Fr Load								9645		

* Refer to the notes at the end of the tables of this range

XEOBIB™

Tire specifications and pressure table. Load per tire in lbs.*

Rim Size (inch)		Description						MSPN (CAI)		
34		VF 600/60 R34 149D TL						78329 (664777)		
Section Width	Overall Diam. (in.)	Loaded Radius (in.)	Rolling Circum. (in.)	Recommended Rim	Acceptable Rims			Min. Dual / Triple Spacing (in.)	75% internal volume (gal.)	Tread depth (32nd in.)
23.4	62.8	27.2	185	DW20B (A)				30.2	109.7	61
Psi	6	7	9	10	12	13	15	26		
6 mph **	4995	5445	5895	6470	7035	7465	7880			
20 mph	4630	5050	5465	5995	6525	6925	7310			
40 mph	4540	4950	5355	5875	6395	6780	7165			
40 mph Dual	4000	4365	4720	5170	5620	5965	6305			
6 mph Fr Load								10030		

Rim Size (inch)		Description						MSPN (CAI)		
38		VF 600/60 R38 151D TL						80626 (349257)		
Section Width	Overall Diam. (in.)	Loaded Radius (in.)	Rolling Circum. (in.)	Recommended Rim	Acceptable Rims			Min. Dual / Triple Spacing (in.)	75% internal volume (gal.)	Tread depth (32nd in.)
21.6	66.9	29.5	197.8	DW20B (A)	MW20B (A)			30.2	119.2	66
Psi	6	7	9	10	12	13	15	26		
6 mph **	5290	5775	6250	6770	7275	7825	8365			
20 mph	4905	5345	5785	6270	6745	7255	7760			
40 mph	4805	5245	5675	6150	6615	7110	7605			
40 mph Dual	4235	4620	4995	5410	5820	6260	6690			

Rim Size (inch)		Description						MSPN (CAI)		
38		VF 650/60 R38 155D TL						80851 (454365)		
Section Width	Overall Diam. (in.)	Loaded Radius (in.)	Rolling Circum. (in.)	Recommended Rim	Acceptable Rims			Min. Dual / Triple Spacing (in.)	75% internal volume (gal.)	Tread depth (32nd in.)
26.7	68.3	29.5	201.1	DW23B (A)	MW23B (A)			32.7	142.4	66
Psi	6	7	9	10	12	13	15	26		
6 mph **	5895	6470	7035	7705	8365	8885	9405			
20 mph	5465	5995	6525	7145	7760	8245	8720			
40 mph	5355	5875	6395	7000	7605	8080	8545			
40 mph Dual	4720	5170	5620	6160	6690	7110	7520			

Rim Size (inch)		Description						MSPN (CAI)		
38		VF 710/60 R38 160D TL						81759 (324138)		
Section Width	Overall Diam. (in.)	Loaded Radius (in.)	Rolling Circum. (in.)	Recommended Rim	Acceptable Rims			Min. Dual / Triple Spacing (in.)	75% internal volume (gal.)	Tread depth (32nd in.)
28	71.4	31.3	210.9	DW25B (A)	MW25B (A)			35.4	175.5	69
Psi	6	7	9	10	12	13	15	26		
6 mph **	6790	7465	8125	8765	9405	10165	10915			
20 mph	6295	6910	7530	8125	8720	9425	10120			
40 mph	6175	6780	7385	7970	8545	9235	9920			
40 mph Dual	5435	5975	6505	7010	7520	8125	8730			

* Refer to the notes at the end of the tables of this range

XEOBIB™

Tire specifications and pressure table. Load per tire in lbs.*

Rim Size (inch)		Description						MSPN (CAI)		
42		VF 650/60 R42 157D TL						10918 (220583)		
Section Width	Overall Diam. (in.)	Loaded Radius (in.)	Rolling Circum. (in.)	Recommended Rim	Acceptable Rims			Min. Dual / Triple Spacing (in.)	75% internal volume (gal.)	Tread depth (32nd in.)
26	72.4	31.9	214.2	DW23B (A)	DW20B (A) (NRO)			32.7	170.3	74
Psi	6	7	9	10	12	13	15	26		
6 mph **	6250	6855	7465	8035	8610	9315	10010			
20 mph	5785	6350	6910	7450	7980	8630	9280			
40 mph	5675	6230	6780	7310	7825	8465	9095			
40 mph Dual	4995	5480	5965	6425	6890	7450	8005			

Rim Size (inch)		Description						MSPN (CAI)		
42		VF 710/60 R42 161D TL						94391 (144294)		
Section Width	Overall Diam. (in.)	Loaded Radius (in.)	Rolling Circum. (in.)	Recommended Rim	Acceptable Rims			Min. Dual / Triple Spacing (in.)	75% internal volume (gal.)	Tread depth (32nd in.)
28.2	75.6	33.2	223.4	DW25B (A)	MW25B (A)			35.4	188.4	71
Psi	6	7	9	10	12	13	15	26		
6 mph **	7035	7705	8365	9195	10010	10615	11220			
20 mph	6525	7145	7760	8520	9280	9845	10405			
40 mph	6395	7000	7605	8355	9095	9645	10195			
40 mph Dual	5620	6160	6690	7350	8005	8490	8975			

***IMPORTANT:**

The inflation pressure must always be appropriate for the load per tire, the speed of travel and the work to be done. Our recommendations above are provided subject to changes made after the date of publication of these tables. Technical data is subject to change without prior notice.

• For plowing and other field applications subject to high torque use the 20 mph line.

- When using single tire configuration:
 - add 6 psi for use on slopes of more than 20%
 - add 6 psi for intense road use exceeding 50%
- **6 mph LT (Low Torque) (max speed 6 mph).
- FRT: Free Rolling Tire



ROADBIB®

THE SOLUTION FOR HEAVY ROAD USE

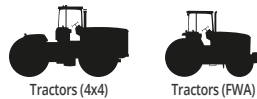

FUEL SAVINGS

- A wide footprint combined with a shallow tread provides low rolling resistance and reduced fuel consumption



LONG LIFE

- Extraordinary longevity: +20% more rubber to the ground vs. MICHELIN MachXBib
- Exclusive design: new tread pattern and directional tires



GREAT COMFORT

- Full central rib improves casing stability and comfort on roads
- Reduced space between patterns (compared to traditional sculptures) helps limit cabin vibration and tire noise



HANDLING & SAFETY

- Outstanding driving quality thanks to a new sculpture similar to that of a truck tire
- Excellent tire adhesion on wet roads thanks to vertical evacuation paths



SIZES

540/65 R30 150D/146E TL

600/70 R30 158D/155E TL

600/70 R30 158D/155E TL

650/60 R34 159D/155E TL

650/65 R34 161D/157E TL

650/65 R42 165D/161E TL

710/70 R42 173D/170E TL

710/70 R42 173D/170E TL

710/75 R42 175D/171E TL

Tire specifications and pressure table. Load per tire in lbs.*

Rim Size (inch)		Description										MSPN (CAI)			
30		540/65 R30 150D/146E TL										92680 (274757)			
Section Width	Overall Diam. (in.)	Loaded Radius (in.)	Rolling Circum. (in.)	Recommended Rim	Acceptable Rims					Min. Dual / Triple Spacing (in.)	75% internal volume (gal.)	Tread depth (32nd in.)			
21.5	57.6	25.8	171.9	DW16L	W18L					28.0	87.6	41			
Psi	6	9	12	15	17	20	23	26	29	32	35	38	41	44	46
6 mph **	4255	4815	5390	5950	6615	7275	7935	8600	9260	9710	10175	10625	11080		
20 mph	3265		3870	4475	5095	5700	6305	6910	7310	7705	8500				
25 mph			3735	4310	4870	5445	6010	6580	6955	7340	7715	8090			
30 mph			3595	4135	4675	5225	5765	6305	6670	7035	7395	7760			
40 mph				3970	4475	4995	5500	6010	6350	6700	7045	7385			
43 mph				3615	4080	4540	5005	5465	5755	6040	6325	6615			

Rim Size (inch)		Description										MSPN (CAI)			
30		600/70 R30 158D/155E TL [DISCONTINUED]										15131 (217911)			
Section Width	Overall Diam. (in.)	Loaded Radius (in.)	Rolling Circum. (in.)	Recommended Rim	Acceptable Rims					Min. Dual / Triple Spacing (in.)	75% internal volume (gal.)	Tread depth (32nd in.)			
24	61.8	26.9	182.3	DW20B (A)	DW18L DW21B (A)					30.5	123.6	50			
Psi	6	9	12	15	17	20	23	26	29	32	35	38	41	44	46
6 mph **	5455	6240	7020	7805	8720	9645	10560	11485	12400	12820	13230	13645	14055		
20 mph	4190		5040	5875	6725	7575	8410	9260	9645	10020	10405	10780			
25 mph			4830	5620	6415	7220	8015	8805	9170	9535	9900	10265			
30 mph			4630	5390	6160	6925	7695	8455	8805	9150	9500	9845			
40 mph				5205	5920	6625	7330	8045	8380	8710	9040	9370			
43 mph				4740	5390	6030	6680	7320	7630	7935	8235	8545			

Rim Size (inch)		Description										MSPN (CAI)			
30		600/70 R30 158D/155E TL [New April 2022]										73799 (264539)			
Section Width	Overall Diam. (in.)	Loaded Radius (in.)	Rolling Circum. (in.)	Recommended Rim	Acceptable Rims					Min. Dual / Triple Spacing (in.)	75% internal volume (gal.)	Tread depth (32nd in.)			
23.7	63.6	28.6	189	DW20B (A)	DW18L DW21B (A)					30.5	123.6	53			
Psi	6	9	12	15	17	20	23	26	29	32	35	38	41	44	46
6 mph **	5050	5965	6890	7805	8720	9645	10560	11485	12400	12820	13230	13645	14055		
20 mph	4245		5125	6010	6890	7770	8655	9535	9875	10230	10570	10915			
25 mph			4850	5655	6470	7275	8090	8895	9270	9645	10020	10395			
30 mph			4650	5425	6205	6980	7750	8520	8885	9250	9600	9965			
40 mph				5205	5910	6615	7330	8045	8380	8710	9040	9370			
43 mph				4740	5380	6020	6670	7320	7560	7795	8035	8265			

Rim Size (inch)		Description										MSPN (CAI)			
34		650/60 R34 159D/155E TL										90034 (556249)			
Section Width	Overall Diam. (in.)	Loaded Radius (in.)	Rolling Circum. (in.)	Recommended Rim	Acceptable Rims					Min. Dual / Triple Spacing (in.)	75% internal volume (gal.)	Tread depth (32nd in.)			
25.6	65	29.5	193.5	DW20B (A)	DW21B (A) DW23B (A)					32.5	131.9	48			
Psi	6	9	12	15	17	20	23	26	29	32	35	38	41	44	46
6 mph **	5455	6175	6890	7605	8565	9525	10485	11440	12400	12920	13435	13955	14475		
20 mph	4190		5040	5875	6725	7575	8410	9260	9720	10175	10635	11090			
25 mph			4830	5620	6415	7220	8015	8805	9250	9690	10120	10560			
30 mph			4630	5390	6160	6925	7695	8455	8875	9290	9710	10130			
40 mph				5070	5820	6560	7295	8045	8445	8850	9250	9645			
43 mph				4620	5290	5975	6645	7320	7630	7935	8235	8545			

* Refer to the notes at the end of the tables of this range

Tire specifications and pressure table. Load per tire in lbs.*

Rim Size (inch)		Description										MSPN (CAI)			
34		650/65 R34 161D/157E TL										35720 (330378)			
Section Width	Overall Diam. (in.)	Loaded Radius (in.)	Rolling Circum. (in.)	Recommended Rim	Acceptable Rims						Min. Dual / Triple Spacing (in.)	75% internal volume (gal.)	Tread depth (32nd in.)		
26.7	67	30.3	199.2	DW20B (A)	DW21B (A) DW23B (A)						32.5	146.6	48		
Psi	6	9	12	15	17	20	23	26	29	32	35	38	41	44	46
6 mph **	5950	6810	7660	8520	9460	10405	11345	12290	13230	13745	14265	14780	15300		
20 mph	4565	5445	6315	7200	8070	8940	9820	10295	10780	11255	11730				
25 mph		5260	6075	6900	7715	8545	9360	9810	10265	10715	11165				
30 mph		5050	5830	6615	7410	8190	8975	9405	9845	10275	10705				
40 mph			5675	6395	7110	7825	8545	8960	9370	9790	10195				
43 mph			5170	5820	6470	7120	7770	8100	8435	8765	9095				

Rim Size (inch)		Description										MSPN (CAI)			
42		650/65 R42 165D/161E TL										37067 (075643)			
Section Width	Overall Diam. (in.)	Loaded Radius (in.)	Rolling Circum. (in.)	Recommended Rim	Acceptable Rims						Min. Dual / Triple Spacing (in.)	75% internal volume (gal.)	Tread depth (32nd in.)		
24.9	76.1	34.3	225.7	DW20B (A)	DW21B(A) DW23B (A)						32.5	169.8	54		
Psi	6	9	12	15	17	20	23	26	29	32	35	38	41	44	46
6 mph **	6615	7495	8380	9260	10305	11345	12390	13425	14475	15115	15750	16390	17030		
20 mph	5070	6020	6980	7925	8875	9835	10780	11355	11925	12490	13060				
25 mph		5865	6745	7630	8500	9380	10265	10805	11355	11895	12435				
30 mph		5620	6470	7310	8155	8995	9845	10360	10890	11410	11925				
40 mph			6175	6980	7770	8575	9370	9865	10360	10860	11355				
43 mph			5620	6350	7075	7805	8530	8950	9370	9780	10195				

Rim Size (inch)		Description										MSPN (CAI)			
42		710/70 R42 173D/170E TL [DISCONTINUED]										27650 (885975)			
Section Width	Overall Diam. (in.)	Loaded Radius (in.)	Rolling Circum. (in.)	Recommended Rim	Acceptable Rims						Min. Dual / Triple Spacing (in.)	75% internal volume (gal.)	Tread depth (32nd in.)		
28.5	79.8	36	237.2	DW23B (A)	DW25B (A)						35.8	229	47		
Psi	6	9	12	15	17	20	23	26	29	32	35	38	41	44	46
6 mph **	8265	9425	10580	11740	13230	14715	16205	17690	19180	19765	20340	20920	21495		
20 mph	6340	7650	8960	10275	11575	12885	14200	14770	15345	15905	16480				
25 mph		7240	8500	9755	11000	12260	13515	14065	14605	15155	15695				
30 mph		6945	8145	9350	10560	11760	12965	13480	14010	14530	15045				
40 mph			7825	8960	10085	11220	12345	12840	13340	13835	14330				
43 mph			7120	8145	9180	10205	11235	11730	12235	12730	13230				

Rim Size (inch)		Description										MSPN (CAI)			
42		710/70 R42 173D/170E TL [New April 2022]										03331 (749845)			
Section Width	Overall Diam. (in.)	Loaded Radius (in.)	Rolling Circum. (in.)	Recommended Rim	Acceptable Rims						Min. Dual / Triple Spacing (in.)	75% internal volume (gal.)	Tread depth (32nd in.)		
28.3	81.7	36.9	243.2	DW23B (A)	DW25B (A)						35.8	229	48		
Psi	6	9	12	15	17	20	23	26	29	32	35	38	41	44	46
6 mph **	8265	9425	10580	11740	13230	14715	16205	17690	19180	19765	20340	20920	21495		
20 mph	6340	7650	8960	10275	11585	12885	14200	14770	15345	15905	16480				
25 mph		7240	8500	9755	11010	12260	13515	14065	14605	15155	15695				
30 mph		6945	8145	9350	10550	11760	12965	13490	14010	14530	15045				
40 mph			7825	8960	10085	11220	12345	12840	13340	13835	14330				
43 mph			7120	8155	9180	10205	11235	11620	12015	12400	12785				

* Refer to the notes at the end of the tables of this range

Tire specifications and pressure table. Load per tire in lbs.*

Rim Size (inch)		Description										MSPN (CAI)			
42		710/75 R42 175D/171E TL										14014 (378080)			
Section Width	Overall Diam. (in.)	Loaded Radius (in.)	Rolling Circum. (in.)	Recommended Rim	Acceptable Rims					Min. Dual / Triple Spacing (in.)	75% internal volume (gal.)	Tread depth (32nd in.)			
29.3	84.3	37.7	250	DW23B (A)	DW21B(A) DW25B (A)					35.8	250.8	54			
Psi	6	9	12	15	17	20	23	26	29	32	35	38	41	44	46
6 mph **	8765	9975	11190	12400	13890	15375	16865	18355	19840	20590	21330	22080	22820		
20 mph	6725	8135	9555	10970	12380	13800	15210	15785	16360	16920	17495				
25 mph		7850	9170	10505	11830	13160	14485	15025	15575	16115	16655				
30 mph		7530	8795	10075	11345	12620	13890	14405	14935	15455	15970				
40 mph			8265	9515	10750	11995	13230	13725	14220	14715	15210				
43 mph			7530	8655	9790	10915	12035	12425	12800	13185	13560				

***IMPORTANT:**

The inflation pressure must always be appropriate for the load per tire, the speed of travel and the work to be done. Our recommendations above are provided subject to changes made after the date of publication of these tables. Technical data is subject to change without prior notice.

• For plowing and other field applications subject to high torque use the 20 mph line.

- When using single tire configuration:
 - add 6 psi for use on slopes of more than 20%
 - add 6 psi for intense road use exceeding 50%
- **6 mph LT (Low Torque) (max speed 6 mph).
- FRT: Free Rolling Tire



CEREXBIB® 2

**OUTSTANDING PRODUCTIVITY
AND SOIL PROTECTION**



LOW PRESSURES FOR LESS SOIL COMPACTION

- CFO+ designation - carry more load at 6 mph cyclic in the field
- Up to 40% less pressure vs standard radial tires¹
- Proven yield increase of +4% using Michelin Ultraflex tires²



TRACTION

- Excellent traction and flotation
- Flexible sidewall delivers larger footprint for larger contact patch with the soil



STEEL CROWN BELTS

- Great stability
- Excellent puncture resistance and optimized load distribution



PRODUCTIVITY

- Huge Load Carrying Capacity – up to 40% more load capacity versus standard radial tires
- High flotation for traction in all conditions and reduced slip



VF/IF Tire



AIR SYSTEMS 
READY

Compatible with Central Tire Inflation Systems

(1) For 26,200 lbs, compared to a 900/60R32 Michelin Megaxbib standard radial
(2) Harper Adams University 2014/2016

SIZES

VF 520/80 R26 CFO+ 168A8 TL

VF 620/70 R26 CFO+ 173A8 TL

VF 750/65 R26 CFO+ 180A8 TL

VF 520/85 R30 CFO+ 172A8 TL

VF 620/70 R30 CFO+ 175A8 TL

VF 710/65 R30 CFO+ 179A8 TL

IF 800/65 R32 CFO+ 181A8 TL

IF 800/70 R32 CFO+ 185A8 TL

VF 900/60 R32 CFO+ 191A8 TL

VF 500/85 R34 CFO+ 172A8 TL

IF 680/80 R38 CFO+ 182A8 TL

IF 800/70 R38 CFO+ 187A8 TL

VF 900/60 R38 CFO+ 193A8 TL

VF 900/60 R38 CFO+ 193A8 TL

VF 520/85 R42 CFO+ 177A8 TL

VF 580/85 R42 CFO+ 183A8 TL

VF 710/70 R42 CFO+ 188A8 TL

IF 800/70 R42 CFO+ 189A8 TL

VF 900/60 R42 CFO+ 195A8 TL

CEREXBIB® 2

Tire specifications and pressure table. Load per tire in lbs.*

Rim Size (inch)		Description										MSPN (CAI)			
26		VF 520/80 R26 CFO+ 168A8 TL										24394 (850494)			
Section Width	Overall Diam. (in.)	Loaded Radius (in.)	Rolling Circum. (in.)	Recommended Rim	Acceptable Rims					Min. Dual / Triple Spacing (in.)	75% internal volume (gal.)	Tread depth (32nd in.)			
19.8	58.7	25.6	173.2	DW16L	DW18L W16L					26.4	96.7	55			
Psi	17	20	23	25	26	28	29	30	32	33	35	36	38	39	41
6 mph Cyc	11530	12800	14055	14350	14650	14935	15235	15530	15820	16115	16400	16755	17110	17450	17800
10 mph Cyc	10505	11660	12820	13085	13360	13625	13890	14155	14420	14685	14945	15265	15600	15915	16235
25 mph	7825	8740	9645	9855	10075	10285	10495	10715	10925	11145	11355	11605	11850	12105	12345

Rim Size (inch)		Description										MSPN (CAI)			
26		VF 620/70 R26 CFO+ 173A8 TL										98039 (228272)			
Section Width	Overall Diam. (in.)	Loaded Radius (in.)	Rolling Circum. (in.)	Recommended Rim	Acceptable Rims					Min. Dual / Triple Spacing (in.)	75% internal volume (gal.)	Tread depth (32nd in.)			
23.9	59.6	25.8	175.6	DW20B (A)						31.1	122.2	57			
Psi	17	20	23	25	26	28	29	30	32	33	35	36	38	39	41
6 mph Cyc	13305	14860	16400	16765	17130	17495	17855	18220	18585	18940	19300	19720	20150	20570	20990
10 mph Cyc	12135	13545	14945	15280	15610	15940	16270	16600	16945	17275	17605	17990	18375	18750	19135
25 mph	9095	10230	11355	11585	11830	12060	12290	12520	12765	12995	13230	13505	13780	14055	14330

Rim Size (inch)		Description										MSPN (CAI)			
26		VF 750/65 R26 CFO+ 180A8 TL										33777 (132266)			
Section Width	Overall Diam. (in.)	Loaded Radius (in.)	Rolling Circum. (in.)	Recommended Rim	Acceptable Rims					Min. Dual / Triple Spacing (in.)	75% internal volume (gal.)	Tread depth (32nd in.)			
29.4	63.9	27.6	188.4	DW25B (A)						37.6	174.1	60			
Psi	17	20	23	25	26	28	29	30	32	33	35	36	38	39	41
6 mph Cyc	16400	18135	19865	20340	20800	21275	21740	22210	22675	23150	23610	24175	24735	25300	25860
10 mph Cyc	14945	16535	18110	18540	18970	19390	19820	20250	20680	21100	21530	22045	22555	23070	23580
25 mph	11355	12455	13560	13880	14200	14505	14825	15145	15465	15775	16095	16480	16865	17250	17635

Rim Size (inch)		Description										MSPN (CAI)			
30		VF 520/85 R30 CFO+ 172A8 TL										86907 (188276)			
Section Width	Overall Diam. (in.)	Loaded Radius (in.)	Rolling Circum. (in.)	Recommended Rim	Acceptable Rims					Min. Dual / Triple Spacing (in.)	75% internal volume (gal.)	Tread depth (32nd in.)			
20.6	63.9	27.9	188.9	W16L						26.9	114.9	58			
Psi	17	20	23	25	26	28	29	30	32	33	35	36	38	39	41
6 mph Cyc	12930	14430	15930	16225	16525	16810	17110	17405	17690	17990	18275	18815	19355	19885	20425
10 mph Cyc	11795	13160	14530	14795	15060	15320	15585	15850	16125	16390	16655	17150	17650	18135	18630
25 mph	8820	9790	10750	11000	11265	11520	11775	12025	12280	12535	12785	13060	13340	13615	13890

Rim Size (inch)		Description										MSPN (CAI)			
30		VF 620/70 R30 CFO+ 175A8 TL										53106 (049288)			
Section Width	Overall Diam. (in.)	Loaded Radius (in.)	Rolling Circum. (in.)	Recommended Rim	Acceptable Rims					Min. Dual / Triple Spacing (in.)	75% internal volume (gal.)	Tread depth (32nd in.)			
23.9	63.6	27.6	187.6	DW20B (A)						31.1	133.5	54			
Psi	17	20	23	25	26	28	29	30	32	33	35	36	38	39	41
6 mph Cyc	14055	15695	17340	17725	18110	18495	18885	19270	19655	20040	20425	20945	21460	21970	22485
10 mph Cyc	12820	14320	15805	16160	16515	16865	17220	17570	17925	18275	18630	19105	19565	20040	20505
25 mph	9920	10970	12015	12245	12490	12720	12950	13185	13425	13660	13890	14220	14550	14880	15210

* Refer to the notes at the end of the tables of this range

CEREXBIB® 2

Tire specifications and pressure table. Load per tire in lbs.*

Rim Size (inch)		Description										MSPN (CAI)			
30		VF 710/65 R30 CFO+ 179A8 TL										22560 (608814)			
Section Width	Overall Diam. (in.)	Loaded Radius (in.)	Rolling Circum. (in.)	Recommended Rim	Acceptable Rims						Min. Dual / Triple Spacing (in.)	75% internal volume (gal.)	Tread depth (32nd in.)		
27.3	66	28.9	195	DW25B (A)	DW23B (A)						34.5	166.4	58		
Psi	17	20	23	25	26	28	29	30	32	33	35	36	38	39	41
6 mph Cyc	15930	17615	19300	19775	20240	20710	21175	21650	22110	22585	23050	23565	24085	24595	25110
10 mph Cyc	14530	16070	17605	18035	18465	18885	19310	19740	20170	20590	21020	21495	21960	22430	22895
25 mph	11025	12125	13230	13535	13835	14145	14440	14750	15045	15355	15655	16015	16370	16735	17085

Rim Size (inch)		Description										MSPN (CAI)			
32		IF 800/65 R32 CFO+ 181A8 TL										25367 (987406)			
Section Width	Overall Diam. (in.)	Loaded Radius (in.)	Rolling Circum. (in.)	Recommended Rim	Acceptable Rims						Min. Dual / Triple Spacing (in.)	75% internal volume (gal.)	Tread depth (32nd in.)		
30.4	73	32.5	216.6	DW27B (A)							39.6	238.5	72		
Psi	17	20	23	25	26	28	29	30	32	33	35	36	38	39	41
6 mph Cyc	19865	21740	23610	24175	24735	25300	25860	26420	26985	27545	28110	28815	29520	30215	30920
10 mph Cyc	18110	19820	21530	22045	22555	23070	23580	24095	24605	25120	25630	26270	26920	27560	28195
25 mph	11685	12785	13890	14220	14550	14880	15210	15545	15875	16205	16535	16955	17360	17780	18190

Rim Size (inch)		Description										MSPN (CAI)			
32		IF 800/70 R32 CFO+ 185A8 TL										71535 (789156)			
Section Width	Overall Diam. (in.)	Loaded Radius (in.)	Rolling Circum. (in.)	Recommended Rim	Acceptable Rims						Min. Dual / Triple Spacing (in.)	75% internal volume (gal.)	Tread depth (32nd in.)		
31.3	76.8	34	228.3	DW27B (A)							39.5	255.1	69		
Psi	17	20	23	25	26	28	29	30	32	33	35	36	38	39	41
6 mph Cyc	21740	24175	26610	27270	27920	28585	29235	29895	30545	31205	31855	32560	33270	33960	34670
10 mph Cyc	19820	22045	24260	24855	25465	26060	26655	27250	27855	28450	29045	29685	30335	30975	31615
25 mph	12785	14220	15655	16040	16425	16810	17195	17580	17970	18355	18740	19160	19565	19985	20395

Rim Size (inch)		Description										MSPN (CAI)			
32		VF 900/60 R32 CFO+ 191A8 TL										73624 (430737)			
Section Width	Overall Diam. (in.)	Loaded Radius (in.)	Rolling Circum. (in.)	Recommended Rim	Acceptable Rims						Min. Dual / Triple Spacing (in.)	75% internal volume (gal.)	Tread depth (32nd in.)		
35.2	74.9	32.6	221.2	DW30B (A)	DW27B (A) (NRO)						44.1	272.8	73		
Psi	17	20	23	25	26	28	29	30	32	33	35	36	38	39	41
6 mph Cyc	21740	24175	26610	27270	27920	28585	29235	29895	30545	31205	31855	32560	33270	33960	34670
10 mph Cyc	19820	22045	24260	24855	25465	26060	26655	27250	27855	28450	29045	29685	30335	30975	31615
25 mph	14770	16480	18190	18675	19160	19630	20115	20600	21085	21560	22045	22540	23040	23535	24030

Rim Size (inch)		Description										MSPN (CAI)			
34		VF 500/85 R34 CFO+ 172A8 TL [DISCONTINUED]										29877 (038009)			
Section Width	Overall Diam. (in.)	Loaded Radius (in.)	Rolling Circum. (in.)	Recommended Rim	Acceptable Rims						Min. Dual / Triple Spacing (in.)	75% internal volume (gal.)	Tread depth (32nd in.)		
19.6	66	29.2	195.3	DW16L	DW18L						25.3	113.7	58		
Psi	17	20	23	25	26	28	29	30	32	33	35	36	38	39	41
6 mph Cyc	12940	14210	15475	15830	16180	16525	16875	17230	17580	17925	18275	18675	19070	19465	19865
10 mph Cyc	11795	12950	14110	14430	14750	15070	15390	15710	16030	16345	16665	17030	17395	17760	18120
25 mph	8820	9790	10750	10945	11155	11355	11550	11750	11950	12145	12345	12730	13120	13505	13890

* Refer to the notes at the end of the tables of this range

CEREXBIB® 2

Tire specifications and pressure table. Load per tire in lbs.*

Rim Size (inch)		Description										MSPN (CAI)			
38		IF 680/80 R38 CFO+ 182A8 TL										20691 (953912)			
Section Width	Overall Diam. (in.)	Loaded Radius (in.)	Rolling Circum. (in.)	Recommended Rim	Acceptable Rims					Min. Dual / Triple Spacing (in.)	75% internal volume (gal.)	Tread depth (32nd in.)			
25.4	79.5	35.6	237.4	DW21B	DW23B (A)					N/A	231.6	74			
Psi	17	20	23	25	26	28	29	30	32	33	35	36	38	39	41
6 mph Cyc	20425	22775	25110	25605	26090	26590	27085	27570	28065	28550	29045	29750	30455	31150	31855
10 mph Cyc	18630	20770	22895	23345	23800	24240	24690	25145	25595	26035	26490	27130	27765	28405	29045
20 mph Cyc	15620	17415	19200	19575	19950	20325	20710	21085	21460	21835	22210	22750	23290	23820	24360
25 mph	12015	13395	14770	15060	15355	15640	15930	16215	16515	16800	17085	17505	17915	18330	18740

Rim Size (inch)		Description										MSPN (CAI)			
38		IF 800/70 R38 CFO+ 187A8 TL										25474 (610997)			
Section Width	Overall Diam. (in.)	Loaded Radius (in.)	Rolling Circum. (in.)	Recommended Rim	Acceptable Rims					Min. Dual / Triple Spacing (in.)	75% internal volume (gal.)	Tread depth (32nd in.)			
31.1	80.7	35.9	239.3	DW27B (A)						39.5	287.2	72			
Psi	17	20	23	25	26	28	29	30	32	33	35	36	38	39	41
6 mph Cyc	23610	26335	29045	29630	30215	30800	31395	31980	32560	33145	33730	34435	35140	35835	36540
10 mph Cyc	21530	23995	26455	26995	27535	28065	28605	29145	29685	30215	30755	31395	32035	32675	33310
25 mph	13890	15485	17085	17430	17780	18120	18465	18805	19160	19500	19840	20260	20670	21085	21495

Rim Size (inch)		Description										MSPN (CAI)			
38		VF 900/60 R38 CFO+ 193A8 TL [DISCONTINUED]										31193 (439024)			
Section Width	Overall Diam. (in.)	Loaded Radius (in.)	Rolling Circum. (in.)	Recommended Rim	Acceptable Rims					Min. Dual / Triple Spacing (in.)	75% internal volume (gal.)	Tread depth (32nd in.)			
34.6	79.9	35	235.9	DW30B (A)	DW27B (A) (NRO)					45.0	303.5	73			
Psi	17	20	23	25	26	28	29	30	32	33	35	36	38	39	41
6 mph Cyc	23050	25585	28110	28815	29520	30215	30920	31625	32330	33025	33730	34670	35605	36540	37480
10 mph Cyc	21530	23995	26455	26995	27535	28065	28605	29145	29685	30215	30755	31635	32520	33400	34280
25 mph	16095	17690	19290	19800	20315	20825	21330	21835	22355	22860	23370	23865	24360	24855	25355

Rim Size (inch)		Description										MSPN (CAI)			
38		VF 900/60 R38 CFO+ 193A8 TL										68766 (853285)			
Section Width	Overall Diam. (in.)	Loaded Radius (in.)	Rolling Circum. (in.)	Recommended Rim	Acceptable Rims					Min. Dual / Triple Spacing (in.)	75% internal volume (gal.)	Tread depth (32nd in.)			
34.6	79.8	35	235.7	DW30B (A)	DW27B (A) (NRO)					45.0	303.1	73			
Psi	17	20	23	25	26	28	29	30	32	33	35	36	38	39	41
6 mph Cyc	23050	25585	28110	28815	29520	30215	30920	31625	32330	33025	33730	34670	35605	36540	37480
10 mph Cyc	21530	23995	26455	26995	27535	28065	28605	29145	29685	30215	30755	31635	32520	33400	34280
25 mph	16095	17690	19290	19800	20315	20825	21330	21835	22355	22860	23370	23865	24360	24855	25355

Rim Size (inch)		Description										MSPN (CAI)			
42		VF 520/85 R42 CFO+ 177A8 TL										15337 (270459)			
Section Width	Overall Diam. (in.)	Loaded Radius (in.)	Rolling Circum. (in.)	Recommended Rim	Acceptable Rims					Min. Dual / Triple Spacing (in.)	75% internal volume (gal.)	Tread depth (32nd in.)			
21.3	76.9	34.7	228.6	DW18B(A)	DD18 W18L					26.9	143.8	69			
Psi	17	20	23	25	26	28	29	30	32	33	35	36	38	39	41
6 mph Cyc	14990	16635	18265	18660	19070	19465	19865	20340	20800	21275	21740	22210	22675	23150	23610
10 mph Cyc	13670	15170	16655	17020	17385	17745	18110	18540	18970	19390	19820	20250	20680	21100	21530
6 mph Cyc Dual	13195	14640	16085	16470	16845	17230	17605	17990	18365	18750	19125	19545	19950	20370	20780
10 mph Cyc Dual	12025	13350	14660	15015	15355	15710	16050	16400	16745	17095	17440	17815	18200	18575	18950
25 mph	10195	11495	12785	13040	13285	13535	13780	14030	14275	14530	14770	15100	15430	15765	16095

* Refer to the notes at the end of the tables of this range



CEREXBIB® 2

Tire specifications and pressure table. Load per tire in lbs.*

Rim Size (inch)		Description										MSPN (CAI)			
42		VF 580/85 R42 CFO+ 183A8 TL										45547 (844076)			
Section Width	Overall Diam. (in.)	Loaded Radius (in.)	Rolling Circum. (in.)	Recommended Rim	Acceptable Rims						Min. Dual / Triple Spacing (in.)	75% internal volume (gal.)	Tread depth (32nd in.)		
22.8	80.3	35.6	237.8	DW18B(A)	DW20B						29.7	185	73		
Psi	17	20	23	25	26	28	29	30	32	33	35	36	38	39	41
6 mph Cyc	17800	19775	21740	22155	22585	23005	23425	23845	24275	24690	25110	25860	26610	27360	28110
10 mph Cyc	16235	18035	19820	20205	20590	20975	21365	21740	22125	22510	22895	23580	24260	24945	25630
6 mph Cyc Dual	15675	17405	19135	19510	19875	20250	20615	20990	21350	21725	22090	22750	23415	24075	24735
10 mph Cyc Dual	14285	15860	17440	17780	18120	18455	18795	19135	19480	19810	20150	20755	21350	21960	22555
25 mph	12015	13395	14770	15135	15485	15850	16205	16570	16920	17285	17635	18055	18465	18885	19290

Rim Size (inch)		Description										MSPN (CAI)			
42		VF 710/70 R42 CFO+ 188A8 TL										60118 (499992)			
Section Width	Overall Diam. (in.)	Loaded Radius (in.)	Rolling Circum. (in.)	Recommended Rim	Acceptable Rims						Min. Dual / Triple Spacing (in.)	75% internal volume (gal.)	Tread depth (32nd in.)		
27.8	82.6	36.5	244.4	DW23B (A)	DW25B (A)						35.8	229	81		
Psi	17	20	23	25	26	28	29	30	32	33	35	36	38	39	41
6 mph Cyc	20425	22775	25110	25605	26090	26590	27075	27570	28065	28550	29045	29750	30455	31150	31855
10 mph Cyc	18630	20770	22895	23345	23800	24240	24690	25145	25595	26035	26490	27130	27765	28405	29045
25 mph			17085	17430	17780	18120	18465	18805	19160	19500	19840	20395	20945	21495	22045

Rim Size (inch)		Description										MSPN (CAI)			
42		IF 800/70 R42 CFO+ 189A8 TL										91180 (818789)			
Section Width	Overall Diam. (in.)	Loaded Radius (in.)	Rolling Circum. (in.)	Recommended Rim	Acceptable Rims						Min. Dual / Triple Spacing (in.)	75% internal volume (gal.)	Tread depth (32nd in.)		
30.3	84.7	38	251.5	DW27B (A)	DW25B (A) DW28B (A)						39.5	302.3	73		
Psi	17	20	23	25	26	28	29	30	32	33	35	36	38	39	41
6 mph Cyc	24360	27170	29985	30690	31395	32090	32795	33500	34205	34900	35605	36355	37105	37855	38605
10 mph Cyc	22210	24780	27335	27975	28615	29255	29905	30545	31185	31825	32465	33145	33830	34515	35195
20 mph Cyc	18630	20780	22930	23470	24010	24535	25080	25620	26160	26685	27225	27800	28375	28945	29520
25 mph	14330	15985	17635	18055	18465	18885	19290	19710	20115	20535	20945	21385	21825	22265	22710

Rim Size (inch)		Description										MSPN (CAI)			
42		VF 900/60 R42 CFO+ 195A8 TL										03717 (856296)			
Section Width	Overall Diam. (in.)	Loaded Radius (in.)	Rolling Circum. (in.)	Recommended Rim	Acceptable Rims						Min. Dual / Triple Spacing (in.)	75% internal volume (gal.)	Tread depth (32nd in.)		
33.2	83.4	36.6	247.3	DW30B (A)	TW30B						N/A	324.1	74		
Psi	17	20	23	25	26	28	29	30	32	33	35	36	38	39	41
6 mph Cyc	24360	27170	29985	30690	31395	32090	32795	33500	34205	34900	35605	36355	37105	37855	38605
10 mph Cyc	22210	24780	27335	27975	28625	29265	29905	30545	31185	31825	32465	33145	33830	34515	35195
20 mph Cyc	18630	20780	22930	23470	24010	24535	25080	25620	26160	26685	27225	27800	28375	28945	29520
25 mph	16535	18465	20395	20975	21550	22135	22710	23205	23700	24195	24690	25220	25740	26270	26785

***IMPORTANT:**

The inflation pressure must always be appropriate for the load per tire, the speed of travel and the work to be done. Our recommendations above are provided subject to changes made after the date of publication of these tables. Technical data is subject to change without prior notice.

- When using single tire configuration:
 - add 6 psi for use on slopes of more than 20%
 - add 6 psi for intense road use exceeding 50%

- 10 mph Cyc: Harvesting work with cyclic loads at 10 mph.
- CFO+: Cyclic Field Operation generating a bonus for cyclic loads in the field at 6 mph (1 mile maximum distance fully loaded).
- NRO (Narrow Rim Option): Add 3 psi to the calculated pressure to make up for the loss in volume of the narrower rim.





CEREXBIB®

**HIGH LOAD CAPACITY AT LOW PRESSURE
FOR LARGE HARVESTING MACHINERY**



Combines



Trailers



LARGE LOAD CAPACITY

- Up to 40% more load capacity²
- CFO rated for high capacity in cyclic operation



TRACTION

- Excellent traction on slopes and the ability to work on wet ground
- +25%³ bigger footprint



LOW PRESSURE, MORE YIELD

- Proven Yield Gains of +4% using Ultraflex tires¹
- Flexible sidewall for larger footprint and lower soil compaction
- 20-40% less air pressure versus standard radial



STEEL CROWN BELTS

- Great stability
- Excellent puncture resistance and optimized load distribution
- Revolutionary strong but flexible casing gives excellent service life



(1) Harper Adams University 2014/2016
(2) Internal test 2013-2015
(3) IF 680/85 R32 MICHELIN ULTRAFLEX vs 680/85 R32 Classic technology

SIZES

VF 520/80 R26 CFO 168A8 TL	IF 800/65 R32 CFO 178A8 TL	IF 800/70 R38 CFO 187A8 TL MI
VF 620/70 R26 CFO 173A8 TL	IF 800/70 R32 CFO 182A8 TL	IF 900/60 R38 CFO 184A8 TL
VF 750/65 R26 CFO 177A8 TL	IF 900/60 R32 CFO 185A8 TL	IF 900/60 R38 CFO 188A8 TL MI
VF 520/85 R30 CFO 172A8 TL	IF 1000/55 R32 CFO 188A8 TL	VF 520/85 R42 CFO 177A8 TL
VF 620/70 R30 CFO 172A8 TL	IF 680/75 R38 CFO 180A8 TL	IF 710/70 R42 CFO 182A8 TL
IF 680/85 R32 CFO 179A8 TL	IF 800/70 R38 CFO 184A8 TL	

Tire specifications and pressure table. Load per tire in lbs.*

Rim Size (inch)		Description										MSPN (CAI)			
26		VF 520/80 R26 CFO 168A8 TL [DISCONTINUED]										61911 (972024)			
Section Width	Overall Diam. (in.)	Loaded Radius (in.)	Rolling Circum. (in.)	Recommended Rim	Acceptable Rims						Min. Dual / Triple Spacing (in.)	75% internal volume (gal.)	Tread depth (32nd in.)		
19.8	58.7	25.6	173.1	DW16L	DW18L W16L						26.4	96.7	55		
Psi	17	20	23	25	26	28	29	30	32	33	35	36	38	39	41
10 mph Cyc	10405	11620	12830	13120	13405	13680	13965	14255	14540	14815	15100	15430	15765	16095	16425
25 mph	7825	8740	9645	9855	10075	10285	10505	10715	10925	11145	11355	11605	11850	12105	12345

Rim Size (inch)		Description										MSPN (CAI)			
26		VF 620/70 R26 CFO 173A8 TL [DISCONTINUED]										64298 (656967)			
Section Width	Overall Diam. (in.)	Loaded Radius (in.)	Rolling Circum. (in.)	Recommended Rim	Acceptable Rims						Min. Dual / Triple Spacing (in.)	75% internal volume (gal.)	Tread depth (32nd in.)		
23.9	59.6	25.8	175.5	DW20B (A)							31.1	122.2	57		
Psi	17	20	23	25	26	28	29	30	32	33	35	36	38	39	41
10 mph Cyc	12090	13605	15100	15410	15730	16040	16345	16655	16975	17285	17595	17970	18330	18705	19070
25 mph	9095	10230	11355	11585	11830	12060	12290	12520	12765	12995	13230	13505	13780	14055	14330

Rim Size (inch)		Description										MSPN (CAI)			
26		VF 750/65 R26 CFO 177A8 TL [DISCONTINUED]										02320 (811382)			
Section Width	Overall Diam. (in.)	Loaded Radius (in.)	Rolling Circum. (in.)	Recommended Rim	Acceptable Rims						Min. Dual / Triple Spacing (in.)	75% internal volume (gal.)	Tread depth (32nd in.)		
29.3	63.9	27.6	188.2	DW25B (A)							37.6	174.1	60		
Psi	17	20	23	25	26	28	29	30	32	33	35	36	38	39	41
10 mph Cyc	15100	16570	18035	18455	18885	19300	19720	20140	20570	20990	21405				
25 mph	11355	12455	13560	13880	14200	14505	14825	15145	15465	15775	16095				

Rim Size (inch)		Description										MSPN (CAI)			
30		VF 520/85 R30 CFO 172A8 TL [DISCONTINUED]										66188 (795916)			
Section Width	Overall Diam. (in.)	Loaded Radius (in.)	Rolling Circum. (in.)	Recommended Rim	Acceptable Rims						Min. Dual / Triple Spacing (in.)	75% internal volume (gal.)	Tread depth (32nd in.)		
20.6	63.9	27.9	188.7	W16L							26.9	114.9	58		
Psi	17	20	23	25	26	28	29	30	32	33	35	36	38	39	41
10 mph Cyc	11730	13020	14295	14640	14980	15310	15655	15995	16335	16665	17010	17370	17745	18110	18475
25 mph	8820	9790	10750	11000	11255	11510	11775	12025	12280	12535	12785	13060	13340	13615	13890

Rim Size (inch)		Description										MSPN (CAI)			
30		VF 620/70 R30 CFO 172A8 TL [DISCONTINUED]										92780 (886789)			
Section Width	Overall Diam. (in.)	Loaded Radius (in.)	Rolling Circum. (in.)	Recommended Rim	Acceptable Rims						Min. Dual / Triple Spacing (in.)	75% internal volume (gal.)	Tread depth (32nd in.)		
23.5	63.6	27.6	187.4	DW20B (A)							31.1	133.5	54		
Psi	17	20	23	25	26	28	29	30	32	33	35	36	38	39	41
10 mph Cyc	13195	14595	15985	16290	16610	16920	17230	17540	17855	18165	18475				
25 mph	9920	10970	12015	12245	12490	12720	12950	13185	13425	13660	13890				

* Refer to the notes at the end of the tables of this range

Tire specifications and pressure table. Load per tire in lbs.*

Rim Size (inch)		Description										MSPN (CAI)			
32		IF 680/85 R32 CFO 179A8 TL										18128 (932041)			
Section Width	Overall Diam. (in.)	Loaded Radius (in.)	Rolling Circum. (in.)	Recommended Rim	Acceptable Rims					Min. Dual / Triple Spacing (in.)	75% internal volume (gal.)	Tread depth (32nd in.)			
26.9	76.2	33.2	224.8	DW23B (A)	DW21B (A)					34.2	226.8	58			
Psi	17	20	23	25	26	28	29	30	32	33	35	36	38	39	41
10 mph Cyc	18630	20770	22895	23345	23800	24240	24690	25145	25595	26035	26490				
25 mph	12015	13395	14770	15060	15355	15640	15930	16215	16515	16800	17085				

Rim Size (inch)		Description										MSPN (CAI)			
32		IF 800/65 R32 CFO 178A8 TL [DISCONTINUED]										39571 (651074)			
Section Width	Overall Diam. (in.)	Loaded Radius (in.)	Rolling Circum. (in.)	Recommended Rim	Acceptable Rims					Min. Dual / Triple Spacing (in.)	75% internal volume (gal.)	Tread depth (32nd in.)			
30.2	73	32.2	216.3	DW27B (A)	DW30B (A)					39.6	238.5	72			
Psi	17	20	23	25	26	28	29	30	32	33	35	36	38	39	41
10 mph Cyc	18110	19820	21530	22045	22555	23070	23580	24095	24605	25120	25630				
25 mph	11685	12785	13890	14220	14550	14880	15210	15545	15875	16205	16535				

Rim Size (inch)		Description										MSPN (CAI)			
32		IF 800/70 R32 CFO 182A8 TL										18258 (525718)			
Section Width	Overall Diam. (in.)	Loaded Radius (in.)	Rolling Circum. (in.)	Recommended Rim	Acceptable Rims					Min. Dual / Triple Spacing (in.)	75% internal volume (gal.)	Tread depth (32nd in.)			
30.9	77.1	34	227.9	DW27B (A)						39.5	255.1	69			
Psi	17	20	23	25	26	28	29	30	32	33	35	36	38	39	41
10 mph Cyc	19820	22045	24260	24855	25465	26060	26655	27250	27855	28450	29045				
25 mph	12785	14220	15655	16040	16425	16810	17195	17580	17970	18355	18740				

Rim Size (inch)		Description										MSPN (CAI)			
32		IF 900/60 R32 CFO 185A8 TL [DISCONTINUED]										03456 (752825)			
Section Width	Overall Diam. (in.)	Loaded Radius (in.)	Rolling Circum. (in.)	Recommended Rim	Acceptable Rims					Min. Dual / Triple Spacing (in.)	75% internal volume (gal.)	Tread depth (32nd in.)			
33.7	75	33.2	222.2	DW27B (A)	DW30B (A)					44.1	272.8	73			
Psi	17	20	23	25	26	28	29	30	32	33	35	36	38	39	41
10 mph Cyc	19820	22035	24250	24845	25450	26050	26655	27250	27845	28450	29045	29685	30335	30975	31615
25 mph	12785	14220	15655	16040	16425	16810	17195	17580	17970	18355	18740	19160	19565	19985	20395

Rim Size (inch)		Description										MSPN (CAI)			
32		IF 1000/55 R32 CFO 188A8 TL										22858 (131720)			
Section Width	Overall Diam. (in.)	Loaded Radius (in.)	Rolling Circum. (in.)	Recommended Rim	Acceptable Rims					Min. Dual / Triple Spacing (in.)	75% internal volume (gal.)	Tread depth (32nd in.)			
40.9	76	34.7	226.7	36.00VA						49.5	311	74			
Psi	17	20	23	25	26	28	29	30	32	33	35	36	38	39	41
10 mph Cyc	21530	24010	26490	27130	27765	28405	29055	29695	30335	30975	31615	32255	32895	33530	34170
25 mph	13890	15485	17085	17505	17915	18330	18740	19160	19565	19985	20395	20810	21220	21640	22045

* Refer to the notes at the end of the tables of this range

Tire specifications and pressure table. Load per tire in lbs.*

Rim Size (inch)		Description										MSPN (CAI)			
38		IF 680/75 R38 CFO 180A8 TL										02720 (833220)			
Section Width	Overall Diam. (in.)	Loaded Radius (in.)	Rolling Circum. (in.)	Recommended Rim	Acceptable Rims					Min. Dual / Triple Spacing (in.)	75% internal volume (gal.)	Tread depth (32nd in.)			
26.1	77.4	34.4	229.3	DW23B (A)	DW21B (A)					32.7	212.2	74			
Psi	17	20	23	25	26	28	29	30	32	33	35	36	38	39	41
10 mph Cyc	17595	19565	21530	22045	22555	23070	23580	24095	24605	25120	25630	26060	26490	26905	27335
10 mph Cyc > slope 20%				17595	18575	19565	20545	21530	22045	22555	23070	23580	24095	24605	25120
25 mph	11355	12620	13890	14220	14550	14880	15210	15545	15875	16205	16535	16810	17085	17360	17635

Rim Size (inch)		Description										MSPN (CAI)			
38		IF 800/70 R38 CFO 184A8 TL [DISCONTINUED]										39234 (646846)			
Section Width	Overall Diam. (in.)	Loaded Radius (in.)	Rolling Circum. (in.)	Recommended Rim	Acceptable Rims					Min. Dual / Triple Spacing (in.)	75% internal volume (gal.)	Tread depth (32nd in.)			
31	80	35.7	239.1	DW27B (A)						25.8	287.2	72			
Psi	17	20	23	25	26	28	29	30	32	33	35	36	38	39	41
10 mph Cyc	21530	23995	26455	26995	27535	28065	28605	29145	29685	30215	30755				
25 mph	13890	15485	17085	17430	17780	18120	18465	18805	19160	19500	19840				

Rim Size (inch)		Description										MSPN (CAI)			
38		IF 800/70 R38 CFO 187A8 TL MI [DISCONTINUED]										24897 (445898)			
Section Width	Overall Diam. (in.)	Loaded Radius (in.)	Rolling Circum. (in.)	Recommended Rim	Acceptable Rims					Min. Dual / Triple Spacing (in.)	75% internal volume (gal.)	Tread depth (32nd in.)			
31.1	80.7	35.9	239.3	DW27B (A)						39.5	287.2	72			
Psi	17	20	23	25	26	28	29	30	32	33	35	36	38	39	41
10 mph Cyc	21530	23995	26455	26995	27535	28065	28605	29145	29685	30215	30755	31395	32035	32675	33310
25 mph	13890	15485	17085	17430	17780	18120	18465	18805	19160	19500	19840	20260	20670	21085	21495

Rim Size (inch)		Description										MSPN (CAI)			
38		IF 900/60 R38 CFO 188A8 TL [DISCONTINUED]										14429 (296920)			
Section Width	Overall Diam. (in.)	Loaded Radius (in.)	Rolling Circum. (in.)	Recommended Rim	Acceptable Rims					Min. Dual / Triple Spacing (in.)	75% internal volume (gal.)	Tread depth (32nd in.)			
34	80	35.6	236.9	DW30B (A)						35.9	303.5	73			
Psi	17	20	23	25	26	28	29	30	32	33	35	36	38	39	41
10 mph Cyc	21530	23995	26455	26995	27535	28065	28605	29145	29685	30215	30755				
25 mph	13890	15485	17085	17430	17780	18120	18465	18805	19160	19500	19840				

Rim Size (inch)		Description										MSPN (CAI)			
38		IF 900/60 R38 CFO 188A8 TL MI [DISCONTINUED]										03936 (853436)			
Section Width	Overall Diam. (in.)	Loaded Radius (in.)	Rolling Circum. (in.)	Recommended Rim	Acceptable Rims					Min. Dual / Triple Spacing (in.)	75% internal volume (gal.)	Tread depth (32nd in.)			
34.6	79.9	35.5	236.9	DW30B (A)						45.0	303.5	73			
Psi	17	20	23	25	26	28	29	30	32	33	35	36	38	39	41
10 mph Cyc	21530	23995	26455	26995	27535	28065	28605	29145	29685	30215	30755	31635	32520	33400	34280
25 mph	13890	15485	17085	17430	17780	18120	18465	18805	19160	19500	19840	20395	20945	21495	22045

* Refer to the notes at the end of the tables of this range

Tire specifications and pressure table. Load per tire in lbs.*

Rim Size (inch)		Description										MSPN (CAI)			
42		VF 520/85 R42 CFO 177A8 TL [DISCONTINUED]										78620 (934265)			
Section Width	Overall Diam. (in.)	Loaded Radius (in.)	Rolling Circum. (in.)	Recommended Rim		Acceptable Rims					Min. Dual / Triple Spacing (in.)	75% internal volume (gal.)	Tread depth (32nd in.)		
21.3	76.9	34.7	228.6	DW18B(A)		DD18 DW18L					26.9	143.8	69		
Psi	17	20	23	25	26	28	29	30	32	33	35	36	38	39	41
10 mph Cyc Dual	12025	12930	13835	14285	14740	15180	15630	16085	16535	16985	17440	17815	18200	18575	18950
25 mph	10195	10955	11720	12105	12490	12865	13250	13625	14010	14385	14770	15100	15430	15765	16095

Rim Size (inch)		Description										MSPN (CAI)			
42		IF 710/70 R42 CFO 182A8 TL [DISCONTINUED]										61530 (003912)			
Section Width	Overall Diam. (in.)	Loaded Radius (in.)	Rolling Circum. (in.)	Recommended Rim		Acceptable Rims					Min. Dual / Triple Spacing (in.)	75% internal volume (gal.)	Tread depth (32nd in.)		
27.8	82.6	37.1	245.3	DW23B(A)							35.8	230.4	81		
Psi	17	20	23	25	26	28	29	30	32	33	35	36	38	39	41
10 mph Cyc Dual		20505	22895	23345	23790	24240	24690	25135	25585	26025	26480	27115	27765	28405	29045
25 mph		13230	14770	15060	15355	15640	15930	16215	16515	16800	17085	17505	17915	18330	18740

***IMPORTANT:**

The inflation pressure must always be appropriate for the load per tire, the speed of travel and the work to be done. Our recommendations above are provided subject to changes made after the date of publication of these tables. Technical data is subject to change without prior notice.

CEREXBIB tires carrying the markings IF or VF and CFO have been developed to comply with the experimental ETRTO standard, introduced in 2014 for a period of 4 months, prior to the possible adoption of a new standard. Tires which meet this new experimental standard must carry the letters IF or VF as a prefix to the size and the letters CFO as a suffix, and tolerate the increase in load indicated in the table above. Tires not carrying this special marking cannot tolerate an increase in load in cyclic load conditions.

- When using single tire configuration:
 - add 6 psi for use on slopes of more than 20%
 - add 6 psi for intense road use exceeding 50%
- 10 mph Cyc: Harvesting work with cyclic loads at 10 mph.
- CFO: Cyclic Field Operation generating a bonus for cyclic loads in the field at 10 mph (1 mile maximum distance fully loaded).



FLOATXBIB®

**THE HIGHEST LOAD CAPACITY IN THE FIELD
AND HIGHEST SPEED INDEX ON ROADS**

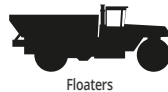

MICHELIN INNOVATION

- 1st VF CFO index E for floater usage – (CFO allows an increased load capacity of 55% when operating under 10 mph)



PRODUCTIVITY

- Optimum pressure distribution; excellent stubble and wear resistance
- New innovative tread pattern and rubber compound providing ULTRAFLEX benefits: low pressure, high load carrying capacity, increased flotation
- E speed rating



LESS PRESSURE, MORE SOIL PROTECTION

- Rounded shoulders protect crops
- Doubled & reinforced shoulder lugs improve contact patch
- Very High Flexion tire can run at up to 40% less air pressure than standard radial.



DESIGNED FOR COMFORT

- Reinforced central area with special lug design
- Low pressure in the field for smooth, comfortable ride



STUBBLE SHIELD

- Stubble Shield Technology helps fight stubble damage

SIZES

VF 1000/50 R25 CFO 190D/186E TL

IF 1000/55 R32 CFO 191D/188E TL

VF 900/60 R38 CFO 196D/192E TL

VF 750/50 R26 CFO 174D/170E TL

VF 1000/55 R32 CFO 197D/193E TL

FLOATXBIB®

Tire specifications and pressure table. Load per tire in lbs.*

Rim Size (inch)		Description									MSPN (CAI)		
25		VF 1000/50 R25 CFO 190D/186E TL									20271 (713716)		
Section Width	Overall Diam. (in.)	Loaded Radius (in.)	Rolling Circum. (in.)	Recommended Rim	Acceptable Rims						Min. Dual / Triple Spacing (in.)	75% internal volume (gal.)	Tread depth (32nd in.)
40.4	64.7	28	190.6	36.0TH							49.5	235.7	50
Psi	17	20	23	26	29	32	35	38	41	44	46		
10 mph Cyc	18110	20160	22210	23235	24260	25375	26485	27765	29045	29905	30755		
20 mph Cyc	15190	16910	18630	19490	20350	21285	22210	23290	24360	25080	25795		
40 mph	13560	15045	16535	17360	18190	19015	19840	20670	21495	22430	23370		
43 mph	12340	13690	15045	15795	16550	17305	18055	18805	19560	20250	20945		

Rim Size (inch)		Description									MSPN (CAI)		
26		VF 750/50 R26 CFO 174D/170E TL									10112 (982905)		
Section Width	Overall Diam. (in.)	Loaded Radius (in.)	Rolling Circum. (in.)	Recommended Rim	Acceptable Rims						Min. Dual / Triple Spacing (in.)	75% internal volume (gal.)	Tread depth (32nd in.)
29.5	55.3	24.4	163.6	DW25B (A)								120.8	49
Psi	17	20	23	26	29	32	35	38	41	44	46		
10 mph Cyc	11450	12775	14095	14740	15375	16015	16660	17635	18625	19225	19820		
20 mph Cyc	9600	10715	11825	12355	12895	13435	13975	14795	15620	16125	16625		
40 mph	8545	9515	10470	11080	11685	12235	12785	13340	13890	14330	14770		
43 mph	7775	8655	9530	10085	10635	11135	11635	12135	12640	12930	13230		

Rim Size (inch)		Description									MSPN (CAI)		
32		IF 1000/55 R32 CFO 191D/188E TL [DISCONTINUED 2H 2022]									21874 (564739)		
Section Width	Overall Diam. (in.)	Loaded Radius (in.)	Rolling Circum. (in.)	Recommended Rim	Acceptable Rims						Min. Dual / Triple Spacing (in.)	75% internal volume (gal.)	Tread depth (32nd in.)
41	73.9	32.3	218.1	36.00VA							49.5	311	48
Psi	17	20	23	26	29	32	35	38	41	44	46		
10 mph Cyc	21530	24010	26485	27765	29045	30325	31610	32895	34170	35715	37245		
20 mph Cyc	18055	20140	22210	23290	24360	25440	26510	27590	28660	29950	31240		
40 mph	13890	15485	17085	17915	18740	19565	20395	21220	22045	23040	24030		
43 mph	12785	14220	15655	16370	17085	17915	18740	19565	20395	21220	22045		

Rim Size (inch)		Description									MSPN (CAI)		
32		VF 1000/55 R32 CFO 197D/193E TL									22389 (946690)		
Section Width	Overall Diam. (in.)	Loaded Radius (in.)	Rolling Circum. (in.)	Recommended Rim	Acceptable Rims						Min. Dual / Triple Spacing (in.)	75% internal volume (gal.)	Tread depth (32nd in.)
41	73.9	31.8	217.4	36.00VA							49.5	311	49
Psi	17	20	23	26	29	32	35	38	41	44	46		
10 mph Cyc	21530	24010	26490	27765	29045	30335	31615	32895	34170	35715	37245		
20 mph Cyc	18055	20140	22210	23290	24360	25440	26510	27590	28660	29950	31240		
40 mph	16095	17140	18190	20115	22045	23040	24030	25020	26015	27170	28330		
43 mph	14660	15600	16535	18300	20060	20945	21825	22765	23700	24745	25795		

* Refer to the notes at the end of the tables of this range

FLOATXBIB®

Tire specifications and pressure table. Load per tire in lbs.*

Rim Size (inch)		Description									MSPN (CAI)		
38		VF 900/60 R38 CFO 196D/192E TL									02123 (098689)		
Section Width	Overall Diam. (in.)	Loaded Radius (in.)	Rolling Circum. (in.)	Recommended Rim	Acceptable Rims						Min. Dual / Triple Spacing (in.)	75% internal volume (gal.)	Tread depth (32nd in.)
34.4	80.3	36	237.8	DW30B (A)	DW27B (A) (NRO)						45.0	303.5	49
Psi	17	20	23	26	29	32	35	38	41	44	46		
10 mph Cyc	21015	23325	25630	27335	29045	29905	30755	32465	34170	35195	36220		
20 mph Cyc	17625	19565	21495	22930	24360	25080	25795	27225	28660	29520	30380		
40 mph	16095	17690	19290	20395	21495	22430	23370	24360	25355	26455	27560		
43 mph	14645	16105	17555	18565	19560	20415	21265	22165	23070	23885	24690		

***IMPORTANT:**

The inflation pressure must always be appropriate for the load per tire, the speed of travel and the work to be done. Our recommendations above are provided subject to changes made after the date of publication of these tables. Technical data is subject to change without prior notice.

- When using single tire configuration:
 - add 6 psi for use on slopes of more than 20%
 - add 6 psi for intense road use exceeding 50%
- 10 mph Cyc: Harvesting work with cyclic loads at 10 mph.
- CFO: Cyclic Field Operation generating a bonus for cyclic loads in the field at 10 mph (1 mile maximum distance fully loaded).



MEGAXBIB® 2

EXCELLENT SOLUTION FOR HARVESTERS, FLOATERS AND HEAVY EQUIPMENT



Combines



Floaters



ROBUST AND STUBBLE RESISTANT

- Reinforced carcass
- Longer tire life



MEGAXBIB 2 BENEFITS

- Excellent road handling
- High load/speed capacities



STEEL CROWN BELTS

- Great stability
- Excellent puncture resistance and optimized load distribution



STUBBLE SHIELD

- Now with Stubble Shield Technology to fight stubble damage
- Extended stubble warranty available



SIZES

1000/50 R25 172A8/166D TL

750/50 R26 160A8/154D TL

650/75 R32 172A8/172B TL

800/65 R32 178A8/178B TL

800/70 R32 181A8/181B TL

900/60 R32 181A8/181B TL

1050/50 R32 178A8/172D TL

710/75 R34 178A8/178B TL

620/70 R38 170A8/170B TL

MEGAXBIB® 2

Tire specifications and pressure table. Load per tire in lbs.*

Rim Size (inch)		Description										MSPN (CAI)			
25		1000/50 R25 172A8/166D TL										76362 (852423)			
Section Width	Overall Diam. (in.)	Loaded Radius (in.)	Rolling Circum. (in.)	Recommended Rim	Acceptable Rims					Min. Dual / Triple Spacing (in.)	75% internal volume (gal.)	Tread depth (32nd in.)			
40.7	65.1	28.8	193.2	36.0TH						48.5	235.5	58			
Psi	15	19	23	28	32	33	35	36	38	39	41	42	46	51	55
6 mph Cyc				18275	19855	21440	21960	22485	22775	23050	23335	23610			
20 mph Cyc				14475	16490	18495	19170	19840	20095	20340	20590	20835			
6 mph	12820	15300	17065	18485	19895	20360	20835								
20 mph	9140	10915	12500	13380	14275	14560	14860								
25 mph	8545	10195	11685	12510	13340	13615	13890								
40 mph	7175	8565	9810	10505	11200	11430	11660								

Rim Size (inch)		Description										MSPN (CAI)			
26		750/50 R26 160A8/154D TL										81321 (236906)			
Section Width	Overall Diam. (in.)	Loaded Radius (in.)	Rolling Circum. (in.)	Recommended Rim	Acceptable Rims					Min. Dual / Triple Spacing (in.)	75% internal volume (gal.)	Tread depth (32nd in.)			
29.2	55.4	24.8	164.2	DW25B (A)						37.6	123	49			
Psi	15	19	23	28	32	33	35	36	38	39	41	42	46	51	55
6 mph Cyc				11530	12480	13425	13735	14055	14405	14760	15115	15465	15805	16865	
20 mph Cyc				9260	10440	11620	12005	12400	12710	13030	13340	13645	13955	14880	
6 mph	8265	9700	11410	12245	13085	13370	13645	13955	14265	14575	14880				
20 mph	5895	6910	8135	8730	9335	9535	9735	9955	10175	10395	10615				
25 mph	5510	6460	7605	8170	8720	8905	9095	9305	9500	9710	9920				
40 mph	4630	5435	6395	6855	7330	7485	7640	7815	7980	8155	8335				

Rim Size (inch)		Description										MSPN (CAI)			
32		650/75 R32 172A8/172B TL										38157 (642277)			
Section Width	Overall Diam. (in.)	Loaded Radius (in.)	Rolling Circum. (in.)	Recommended Rim	Acceptable Rims					Min. Dual / Triple Spacing (in.)	75% internal volume (gal.)	Tread depth (32nd in.)			
25.2	72.3	32.3	213.5	DW21B (A)	DW20B (A) DW23B (A)					34.4	170.9	71			
Psi	15	19	23	28	32	33	35	36	38	39	41	42	46	51	55
6 mph Cyc	10805	12590	14375	15630	16900	17315	17735	18155	18575	18995	19410	19830	21085	22355	23610
6 mph	9920	11510	13095	14155	15200	15555	15905	16260	16610	16965	17315	17670	18730	19775	20835
15 mph	8005	9335	10670	11565	12445	12745	13040	13340	13635	13935	14230	14530	15410		
20 mph	7715	9005	10295	11155	12005	12290	12575	12865	13150	13435	13725	14010	14860		
25 mph	7230	8420	9610	10415	11220	11485	11750	12015	12290	12555	12820	13085	13890		
30 mph	7230	8420	9610	10415	11220	11485	11750	12015	12290	12555	12820	13085	13890		

Rim Size (inch)		Description										MSPN (CAI)			
32		800/65 R32 178A8/178B TL										87985 (135425)			
Section Width	Overall Diam. (in.)	Loaded Radius (in.)	Rolling Circum. (in.)	Recommended Rim	Acceptable Rims					Min. Dual / Triple Spacing (in.)	75% internal volume (gal.)	Tread depth (32nd in.)			
30.9	72.4	32.8	215.4	DW27B (A)	DH27(B) DW25B (A)					39.7	230	71			
Psi	15	19	23	28	32	33	35	36	38	39	41	42	46	51	55
6 mph Cyc	12930	15610	18275	19575	20880	21310	21740	22210	22675	23150	23610	24065	25410	26765	28110
6 mph	11410	13360	15300	16755	18210	18695	19180	19600	20005	20425	20835	21230	22420	23610	24800
15 mph	9790	11385	12975	13890	14815	15115	15420	15785	16160	16525	16885	17250	18355		
20 mph	9435	10970	12500	13380	14275	14560	14860	15210	15575	15930	16280	16635	17690		
25 mph	8820	10250	11685	12510	13340	13615	13890	14220	14550	14880	15210	15545	16535		
30 mph	8820	10250	11685	12510	13340	13615	13890	14220	14550	14880	15210	15545	16535		

* Refer to the notes at the end of the tables of this range



MEGAXBIB® 2

Tire specifications and pressure table. Load per tire in lbs.*

Rim Size (inch)		Description										MSPN (CAI)			
32		800/70 R32 181A8/181B TL										85778 (366785)			
Section Width	Overall Diam. (in.)	Loaded Radius (in.)	Rolling Circum. (in.)	Recommended Rim	Acceptable Rims					Min. Dual / Triple Spacing (in.)	75% internal volume (gal.)	Tread depth (32nd in.)			
31.7	76.3	35.2	226.8	DW27B (A)	DW25B (A)					39.7	255.1	71			
Psi	15	19	23	28	32	33	35	36	38	39	41	42	46	51	55
6 mph Cyc	14055	17240	20425	21970	23425	23900	24360	24735	25110	25485	25860	26365	27890	29400	30920
6 mph	12400	14715	17030	19465	20890	21195	21495	21825	22155	22485	22820	23270	24605	25950	27280
12.5 mph	11760	14020	16270	17185	18100	18400	18705	19170	19620	20085	20545	21000	22375		
15 mph	10615	12655	14685	15510	16335	16610	16885	17305	17715	18135	18540	18960	20195		
20 mph	10320	12235	14155	14945	15740	16005	16270	16665	17075	17470	17870	18265	19465		
25 mph	9645	11440	13230	13975	14715	14970	15210	15585	15960	16325	16700	17075	18190		
30 mph	9645	11440	13230	13975	14715	14970	15210	15585	15960	16325	16700	17075	18190		

Rim Size (inch)		Description										MSPN (CAI)			
32		900/60 R32 181A8/181B TL										04361 (166896)			
Section Width	Overall Diam. (in.)	Loaded Radius (in.)	Rolling Circum. (in.)	Recommended Rim	Acceptable Rims					Min. Dual / Triple Spacing (in.)	75% internal volume (gal.)	Tread depth (32nd in.)			
33.9	74.8	33.4	221.9	DW27B (A)	DW30B (A)					43.9	272.8	71			
Psi	15	19	23	28	32	33	35	36	38	39	41	42	46	51	55
6 mph Cyc	14055	16965	19865	21550	23235	23800	24360	24925	25485	26050	26610	27040	28330	29630	30920
6 mph	12400	14715	17030	18705	20380	20935	21495	21990	22485	22985	23480	23865	25000	26145	27280
15 mph	10405	12300	14200	15390	16580	16975	17370	17770	18175	18575	18970	19280	20195		
20 mph	10030	11860	13680	14825	15985	16360	16745	17130	17515	17900	18285	18585	19465		
25 mph	9370	11080	12785	13865	14935	15300	15655	16015	16370	16735	17085	17360	18190		
30 mph	9370	11080	12785	13865	14935	15300	15655	16015	16370	16735	17085	17360	18190		

Rim Size (inch)		Description										MSPN (CAI)			
32		1050/50 R32 178A8/172D TL										12011 (424273)			
Section Width	Overall Diam. (in.)	Loaded Radius (in.)	Rolling Circum. (in.)	Recommended Rim	Acceptable Rims					Min. Dual / Triple Spacing (in.)	75% internal volume (gal.)	Tread depth (32nd in.)			
40.8	73.5	32.6	218	36.00VA						51.6	325.7	53			
Psi	15	19	23	28	32	33	35	36	38	39	41	42	46	51	56
6 mph Cyc			21740	23565	25395	26005	26610	26985	27360	27735	28110				
20 mph Cyc			17030	19445	21870	22675	23480	23810	24140	24470	24800				
6 mph	15300	18210	20835	22320	23810	24305	24800								
20 mph	10915	12985	14860	15915	16985	17340	17690								
25 mph	10195	12135	13890	14880	15875	16205	16535								
40 mph	8565	10195	11660	12500	13340	13615	13890								

Rim Size (inch)		Description										MSPN (CAI)			
34		710/75 R34 178A8/178B TL										47924 (312036)			
Section Width	Overall Diam. (in.)	Loaded Radius (in.)	Rolling Circum. (in.)	Recommended Rim	Acceptable Rims					Min. Dual / Triple Spacing (in.)	75% internal volume (gal.)	Tread depth (32nd in.)			
27.6	74.6	33.4	221.9	DW23B (A)	DW21B (A) MW23B (A)					35.8	227.8	71			
Psi	15	19	23	28	32	33	35	36	38	39	41	42	46	51	55
6 mph Cyc	13800	15335	16865	18400	19930	20450	20955	21460	21980	22485	22995	23510	25045	26575	28110
20 mph Cyc	12565	13880	15190	16500	17815	18245	18685	19125	19555	19995	20435	20865	22180	23490	24800
6 mph	10250	11355	12465	13570	14670	15045	15410	15785	16150	16525	16885	17260	18365		
20 mph	9875	10945	12015	13075	14145	14505	14860	15210	15565	15930	16280	16635	17705		
25 mph	9235	10230	11235	12225	13215	13545	13880	14210	14540	14880	15210	15545	16535		
40 mph	9235	10230	11235	12225	13215	13545	13880	14210	14540	14880	15210	15545	16535		

* Refer to the notes at the end of the tables of this range

MEGAXBIB® 2

Tire specifications and pressure table. Load per tire in lbs.*

Rim Size (inch)		Description									MSPN (CAI)				
38		620/70 R38 170A8/170B TL									40381 (126128)				
Section Width	Overall Diam. (in.)	Loaded Radius (in.)	Rolling Circum. (in.)	Recommended Rim	Acceptable Rims					Min. Dual / Triple Spacing (in.)	75% internal volume (gal.)	Tread depth (32nd in.)			
23.8	73.5	33.6	219.1	DW20B (A)	DW18L					31.5	156.3	71			
Psi	15	19	23	28	32	33	35	36	38	39	41	42	46	51	55
6 mph Cyc	11045	12270	13490	14725	15950	16360	16765	17175	17580	17990	18400	18805	20040	21265	22485
6 mph	10055	11100	12145	13195	14255	14595	14945	15300	15640	15995	16345	16700	17745	18795	19840
15 mph	8180	9060	9955	10835	11730	12025	12315	12610	12910	13205	13505	13800	14685		
20 mph	7895	8740	9600	10450	11310	11595	11870	12160	12445	12730	13020	13305	14155		
25 mph	7385	8180	8985	9780	10570	10835	11100	11365	11630	11905	12170	12435	13230		
30 mph	7385	8180	8985	9780	10570	10835	11100	11365	11630	11905	12170	12435	13230		

***IMPORTANT:**

The inflation pressure must always be appropriate for the load per tire, the speed of travel and the work to be done. Our recommendations above are provided subject to changes made after the date of publication of these tables. Technical data is subject to change without prior notice.

- When using single tire configuration:
 - add 6 psi for use on slopes of more than 20%
 - add 6 psi for intense road use exceeding 50%
- For harvesters use 6 mph non-cyclic table and the 20 mph non-cyclic table for floaters.
- 6 mph or 20 mph cyclic load, use in the field only, travel with full load not to exceed 1 mile.



MEGAXBIB®

EXCELLENT SOLUTION FOR HARVESTERS AND HEAVY EQUIPMENT

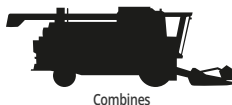

LOAD CAPACITY

- Up to 67,460 lbs¹ per axle



ENDURANCE

- Up to +46%² vs main competitor



COMFORT

- Flexible sidewalls for a smooth, comfortable ride



STEEL CROWN BELTS

- Great stability
- Excellent puncture resistance and optimized load distribution



Conventional Architecture

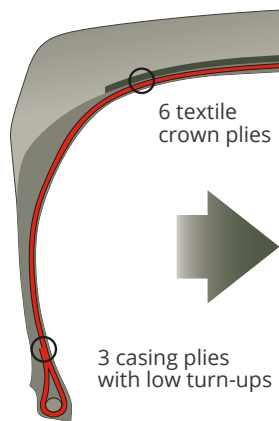

MICHELIN MEGAXBIB, an Innovative Construction

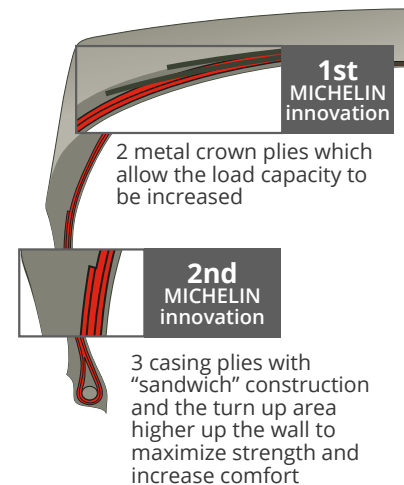

(1) 1050/50 R32 184A8/184B - 6 mph cyc
(2) Internal test (Ladoux - France) study on 800/65R32 178A8/178B

SIZES

620/75 R26 166A8/166B TL	800/70 R32 181A8/181B TL	620/70 R38 170A8/170B TL
750/50 R26 160A8/154D TL	900/60 R32 181A8/181B TL	650/85 R38 173A8/173B TL
750/65 R26 171A8/171B TL	1050/50 R32 178A8 TL M28	520/85 R42 162A8/162B TL
620/75 R30 168A8/168B TL	1050/50 R32 184A8/184B TL T2	620/70 R42 166A8/166B TL
650/75 R32 172A8/172B TL	620/75 R34 170A8/170B TL	
800/65 R32 178A8/178B TL	710/75 R34 178A8/178B TL	

MEGAXBIB®

Tire specifications and pressure table. Load per tire in lbs.*

Rim Size (inch)		Description										MSPN (CAI)			
26		620/75 R26 166A8/166B TL										89936 (614320)			
Section Width	Overall Diam. (in.)	Loaded Radius (in.)	Rolling Circum. (in.)	Recommended Rim	Acceptable Rims						Min. Dual / Triple Spacing (in.)	75% internal volume (gal.)	Tread depth (32nd in.)		
23.1	63.1	28	186.9	DW20B (A)	DW18L						31.5	136.3	58		
Psi	15	19	23	28	32	33	35	36	38	39	41	42	46	51	55
6 mph Cyc	9720	10625	11530	12665	13800	14185	14560	14935	15320	15695	16070	16460	17595	18730	19865
6 mph	8620	9710	10805	11720	12630	12940	13250	13560	13855	14165	14475	14770	15695	16610	17525
15 mph	6990	7960	8930	9690	10440	10690	10945	11200	11455	11705	11960	12205	12965		
20 mph	6745	7670	8600	9325	10065	10305	10550	10790	11035	11275	11530	11775	12500		
25 mph	6305	7165	8025	8710	9405	9625	9855	10085	10320	10540	10770	11000	11685		
30 mph	6305	7165	8025	8710	9405	9625	9855	10085	10320	10540	10770	11000	11685		

Rim Size (inch)		Description										MSPN (CAI)			
26		750/50 R26 160A8/154D TL [DISCONTINUED]										67149 (478428)			
Section Width	Overall Diam. (in.)	Loaded Radius (in.)	Rolling Circum. (in.)	Recommended Rim	Acceptable Rims						Min. Dual / Triple Spacing (in.)	75% internal volume (gal.)	Tread depth (32nd in.)		
29	55	24.6	163.9	DW25B (A)								120.8	47		
Psi	15	19	23	28	32	33	35	36	38	39	41	42	46	51	55
6 mph Cyc			11530	12480	13425	13735	14055	14405	14760	15115	15465	15805	16865		
6 mph			9260	10440	11620	12005	12400	12710	13030	13340	13645	13955	14880		
15 mph	8265	9690	11410	12245	13085	13370	13645	13955	14265	14575	14880				
20 mph	5895	6910	8135	8730	9335	9535	9735	9955	10175	10395	10615				
25 mph	5510	6460	7605	8170	8720	8905	9095	9305	9515	9710	9920				
30 mph	4630	5435	6395	6855	7330	7485	7640	7815	7990	8155	8335				

Rim Size (inch)		Description										MSPN (CAI)			
26		750/65 R26 171A8/171B TL										36798 (983217)			
Section Width	Overall Diam. (in.)	Loaded Radius (in.)	Rolling Circum. (in.)	Recommended Rim	Acceptable Rims						Min. Dual / Triple Spacing (in.)	75% internal volume (gal.)	Tread depth (32nd in.)		
28.8	63.8	28.7	189.7	DW25B (A)							37.6	178.9	58		
Psi	15	19	23	28	32	33	35	36	38	39	41	42	46	51	55
6 mph Cyc	10870	12930	14715	16225	17460	17855	18265	18675	19070	19435	19785	20150	21140	22090	23050
6 mph	9590	11200	12700	14065	15300	15675	16060	16445	16820	17140	17460	17770	18650	19500	20340
15 mph	7960	9205	10440	11550	12410	12710	12995	13295	13580	13825	14065	14320	15045		
20 mph	7670	8875	10075	11145	11950	12235	12520	12810	13095	13325	13570	13800	14505		
25 mph	7165	8290	9405	10405	11175	11440	11705	11970	12235	12455	12675	12895	13560		
30 mph	7165	8290	9405	10405	11175	11440	11705	11970	12235	12455	12675	12895	13560		

Rim Size (inch)		Description										MSPN (CAI)			
30		620/75 R30 168A8/168B TL										63928 (753673)			
Section Width	Overall Diam. (in.)	Loaded Radius (in.)	Rolling Circum. (in.)	Recommended Rim	Acceptable Rims						Min. Dual / Triple Spacing (in.)	75% internal volume (gal.)	Tread depth (32nd in.)		
23.8	67.3	30.3	200.1	DW20B (A)	DW18L						31.5	147.6	58		
Psi	15	19	23	28	32	33	35	36	38	39	41	42	46	51	55
6 mph Cyc	10275	11220	12170	13370	14575	14980	15375	15775	16180	16580	16975	17385	18585	19785	20990
6 mph	9105	10250	11400	12370	13340	13670	13990	14310	14640	14960	15280	15610	16580	17550	18520
15 mph	7410	8410	9415	10220	11025	11290	11550	11815	12090	12355	12620	12885	13690		
20 mph	7145	8115	9085	9855	10625	10890	11145	11400	11660	11915	12180	12435	13205		
25 mph	6680	7585	8490	9215	9930	10175	10415	10660	10900	11145	11385	11620	12345		
30 mph	6680	7585	8490	9215	9930	10175	10415	10660	10900	11145	11385	11620	12345		

* Refer to the notes at the end of the tables of this range



MEGAXBIB®

Tire specifications and pressure table. Load per tire in lbs.*

Rim Size (inch)		Description										MSPN (CAI)			
32		650/75 R32 172A8/172B TL [DISCONTINUED]										46686 (468227)			
Section Width	Overall Diam. (in.)	Loaded Radius (in.)	Rolling Circum. (in.)	Recommended Rim	Acceptable Rims					Min. Dual / Triple Spacing (in.)	75% internal volume (gal.)	Tread depth (32nd in.)			
25.9	71.9	32.3	213.5	DW21B (A)	DW20B (A) DW23B (A)					34.4	184.2	74			
Psi	15	19	23	28	32	33	35	36	38	39	41	42	46	51	55
6 mph Cyc	10805	12590	14375	15630	16900	17315	17735	18155	18575	18995	19410	19830	21085	22355	23610
6 mph	9920	11510	13095	14155	15200	15555	15905	16260	16610	16965	17315	17670	18730	19775	20835
15 mph	8005	9335	10670	11565	12445	12745	13040	13340	13635	13935	14230	14515	15410		
20 mph	7715	9005	10295	11155	12005	12290	12575	12865	13150	13435	13725	14000	14860		
25 mph	7230	8420	9610	10415	11220	11485	11750	12015	12290	12555	12820	13085	13890		
30 mph	7230	8420	9610	10415	11220	11485	11750	12015	12290	12555	12820	13085	13890		

Rim Size (inch)		Description										MSPN (CAI)			
32		800/65 R32 178A8/178B TL [DISCONTINUED]										49342 (521809)			
Section Width	Overall Diam. (in.)	Loaded Radius (in.)	Rolling Circum. (in.)	Recommended Rim	Acceptable Rims					Min. Dual / Triple Spacing (in.)	75% internal volume (gal.)	Tread depth (32nd in.)			
31.2	72.4	32.4	214.9	DW27B (A)	DHB27 DW25B (A)					39.7	238.5	71			
Psi	15	19	23	28	32	33	35	36	38	39	41	42	46	51	55
6 mph Cyc	12930	15610	18275	19575	20880	21310	21740	22210	22675	23150	23610	24065	25410	26765	28110
6 mph	11410	13360	15300	16755	18210	18695	19180	19600	20005	20425	20835	21230	22420	23610	24800
15 mph	9790	11385	12975	13890	14815	15115	15420	15785	16160	16525	16885	17250	18355		
20 mph	9435	10970	12500	13380	14275	14560	14860	15210	15575	15930	16280	16635	17690		
25 mph	8820	10250	11685	12510	13340	13615	13890	14220	14550	14880	15210	15545	16535		
30 mph	8820	10250	11685	12510	13340	13615	13890	14220	14550	14880	15210	15545	16535		

Rim Size (inch)		Description										MSPN (CAI)			
32		800/70 R32 181A8/181B TL [DISCONTINUED]										68880 (695992)			
Section Width	Overall Diam. (in.)	Loaded Radius (in.)	Rolling Circum. (in.)	Recommended Rim	Acceptable Rims					Min. Dual / Triple Spacing (in.)	75% internal volume (gal.)	Tread depth (32nd in.)			
31.2	76.2	34.3	225.4	DW27B (A)	DW25B (A)					39.7	255.1	73			
Psi	15	19	23	28	32	33	35	36	38	39	41	42	46	51	55
6 mph Cyc	14055	17240	20425	21970	23425	23900	24360	24735	25110	25485	25860	26365	27890	29400	30920
6 mph	12400	14715	17030	19465	20890	21195	21495	21825	22155	22485	22820	23270	24605	25950	27280
12.5 mph	11760	14020	16270	17185	18100	18400	18705	19170	19620	20085	20545	21000	22375		
15 mph	10615	12655	14685	15510	16335	16610	16885	17305	17715	18135	18540	18960	20195		
20 mph	10320	12235	14155	14945	15740	16005	16270	16665	17075	17470	17870	18265	19465		
25 mph	9645	11440	13230	13975	14715	14970	15210	15585	15960	16325	16700	17075	18190		
30 mph	9645	11440	13230	13975	14715	14970	15210	15585	15960	16325	16700	17075	18190		

Rim Size (inch)		Description										MSPN (CAI)			
32		900/60 R32 181A8/181B TL [DISCONTINUED]										40581 (824122)			
Section Width	Overall Diam. (in.)	Loaded Radius (in.)	Rolling Circum. (in.)	Recommended Rim	Acceptable Rims					Min. Dual / Triple Spacing (in.)	75% internal volume (gal.)	Tread depth (32nd in.)			
34.2	74.6	33.5	221.5	DW27B (A)	DW30B (A)					43.9	272.8	71			
Psi	15	19	23	28	32	33	35	36	38	39	41	42	46	51	55
6 mph Cyc	14055	16965	19865	21550	23235	23800	24360	24925	25485	26050	26610	27040	28330	29630	30920
6 mph	12400	14715	17030	18705	20380	20935	21495	21990	22485	22985	23480	23865	25000	26145	27280
15 mph	10405	12300	14200	15390	16580	16975	17370	17770	18175	18575	18970	19280	20195		
20 mph	10030	11860	13680	14825	15985	16360	16745	17130	17515	17900	18285	18585	19465		
30 mph	9370	11080	12785	13865	14935	15300	15655	16015	16370	16735	17085	17360	18190		

* Refer to the notes at the end of the tables of this range

MEGAXBIB®

Tire specifications and pressure table. Load per tire in lbs.*

Rim Size (inch)		Description										MSPN (CAI)			
32		1050/50 R32 178A8 TL M28										94737 (236234)			
Section Width	Overall Diam. (in.)	Loaded Radius (in.)	Rolling Circum. (in.)	Recommended Rim	Acceptable Rims						Min. Dual / Triple Spacing (in.)	75% internal volume (gal.)	Tread depth (32nd in.)		
40.9	74.9	33.6	222.4	36.00VA							51.6	330.2	76		
Psi	15	19	23	28	32	33	35	36	38	39	41	42	46	51	55
6 mph Cyc	16360	19025	21695	23445	25190	25770	26355	26940	27525	28110					
10 mph Cyc	11795	14715	17635	20570	22905	23590	24275	24615	24955	25300	25640				
6 mph	15125	17470	19820	21175	22540	22995	23445	23900	24350	24800					
15 mph	12280	14340	16400	17140	17880	18120	18365								
20 mph	11840	13825	15805	16525	17230	17470	17705								
25 mph	11065	12920	14770	15430	16095	16315	16535								

Rim Size (inch)		Description										MSPN (CAI)			
32		1050/50 R32 184A8/184B TL T2 [DISCONTINUED]										28613 (829536)			
Section Width	Overall Diam. (in.)	Loaded Radius (in.)	Rolling Circum. (in.)	Recommended Rim	Acceptable Rims						Min. Dual / Triple Spacing (in.)	75% internal volume (gal.)	Tread depth (32nd in.)		
41	73	32.7	216.9	36.00VA								306	52		
Psi	15	19	23	28	32	33	35	36	38	39	41	42	46	51	55
6 mph Cyc	14990	18365	21740	23610	25300	25860	26420	26985	27545	28110	28670	29235	30920	32330	33730
10 mph Cyc	13755	16250	18740	19940	21375	21850	22320	22885	23435	23995	24560	25110	26785	28275	29760
6 mph	11320	13370	15420	16525	17625	17990	18355	18815	19280	19730	20195	20655	22025		
15 mph	10915	12885	14860	15915	16985	17340	17690	18135	18585	19025	19465	19910	21230		
20 mph	10195	12050	13890	14880	15875	16205	16535	16955	17360	17780	18190	18605	19840		
25 mph	10195	12050	13890	14880	15875	16205	16535	16955	17360	17780	18190	18605	19840		

Rim Size (inch)		Description										MSPN (CAI)			
34		620/75 R34 170A8/170B TL										83734 (325025)			
Section Width	Overall Diam. (in.)	Loaded Radius (in.)	Rolling Circum. (in.)	Recommended Rim	Acceptable Rims						Min. Dual / Triple Spacing (in.)	75% internal volume (gal.)	Tread depth (32nd in.)		
23.2	71.4	32.3	212.5	DW20B (A)	DW18L						31.5	161.6	58		
Psi	15	19	23	28	32	33	35	36	38	39	41	42	46	51	55
6 mph Cyc	11045	12270	13490	14725	15950	16360	16765	17175	17580	17990	18400	18805	20040	21265	22485
6 mph	10055	11100	12145	13195	14255	14595	14945	15300	15640	15995	16345	16700	17745	18795	19840
15 mph	8180	9060	9955	10835	11730	12025	12315	12610	12910	13205	13505	13800	14685		
20 mph	7895	8740	9600	10450	11310	11595	11870	12160	12445	12730	13020	13305	14155		
25 mph	7385	8180	8985	9780	10570	10835	11100	11365	11630	11905	12170	12435	13230		
30 mph	7385	8180	8985	9780	10570	10835	11100	11365	11630	11905	12170	12435	13230		

Rim Size (inch)		Description										MSPN (CAI)			
34		710/75 R34 178A8/178B TL [DISCONTINUED]										13589 (543107)			
Section Width	Overall Diam. (in.)	Loaded Radius (in.)	Rolling Circum. (in.)	Recommended Rim	Acceptable Rims						Min. Dual / Triple Spacing (in.)	75% internal volume (gal.)	Tread depth (32nd in.)		
27.2	74.8	33.4	221.9	DW23B (A)	DW21B (A) MW23B (A)						35.8	227.8	73		
Psi	15	19	23	28	32	33	35	36	38	39	41	42	46	51	55
6 mph Cyc	13800	15335	16865	18400	19930	20450	20955	21460	21980	22485	22995	23510	25045	26575	28110
6 mph	12565	13880	15190	16500	17815	18245	18685	19125	19555	19995	20435	20865	22180	23490	24800
15 mph	10250	11355	12465	13570	14670	15045	15410	15785	16150	16525	16885	17260	18365		
20 mph	9875	10945	12015	13075	14145	14505	14860	15210	15565	15930	16280	16635	17705		
25 mph	9235	10230	11235	12225	13215	13545	13880	14210	14540	14880	15210	15545	16535		
30 mph	9235	10230	11235	12225	13215	13545	13880	14210	14540	14880	15210	15545	16535		

* Refer to the notes at the end of the tables of this range



MEGAXBIB®

Tire specifications and pressure table. Load per tire in lbs.*

Rim Size (inch)		Description								MSPN (CAI)					
38		620/70 R38 170A8/170B TL [DISCONTINUED]								99512 (476088)					
Section Width	Overall Diam. (in.)	Loaded Radius (in.)	Rolling Circum. (in.)	Recommended Rim	Acceptable Rims					Min. Dual / Triple Spacing (in.)	75% internal volume (gal.)	Tread depth (32nd in.)			
23.9	73.4	33.5	218.8	DW20B (A)	DW18L					31.5	154.9	69			
Psi	15	19	23	28	32	33	35	36	38	39	41	42	46	51	55
6 mph Cyc	11045	12270	13490		15950	16360	16765	17175	17580	17990	18400	18805	20040	21265	22485
6 mph	10055	11100	12145	13195	14255	14595	14945	15300	15640	15995	16345	16700	17745	18795	19840
15 mph	8180	9060	9955	10835	11730	12025	12315	12610	12910	13205	13505	13800	14685		
20 mph	7895	8740	9600	10450	11310	11595	11870	12160	12445	12730	13020	13305	14155		
25 mph	7385	8180	8985	9780	10570	10835	11100	11365	11630	11905	12170	12435	13230		
30 mph	7385	8180	8985	9780	10570	10835	11100	11365	11630	11905	12170	12435	13230		

Rim Size (inch)		Description								MSPN (CAI)					
38		650/85 R38 173A8/173B TL								19212 (173491)					
Section Width	Overall Diam. (in.)	Loaded Radius (in.)	Rolling Circum. (in.)	Recommended Rim	Acceptable Rims					Min. Dual / Triple Spacing (in.)	75% internal volume (gal.)	Tread depth (32nd in.)			
27.5	80.6	36.7	240.2	DW23B (A)	DW20B (A)					32.5	226.2	79			
Psi	15	19	23	28	32	33	35	36	38	39	41	42	46	51	55
6 mph Cyc Duals	12370	14430	16490	17725	18960	19380	19785	20205	20615	21020	21440				
6 mph	12820	14685	16535	17780	19015	19435	19840	20260	20670	21085	21495				
15 mph	9790	11565	13340	14295	15265	15585	15905								
20 mph	9435	11145	12855	13780	14715	15025	15335								
25 mph	8820	10415	12015	12885	13755	14045	14330								
30 mph	8820	10415	12015	12885	13755	14045	14330								

Rim Size (inch)		Description								MSPN (CAI)					
42		520/85 R42 162A8/162B TL (Textile belted)								15488 (645194)					
Section Width	Overall Diam. (in.)	Loaded Radius (in.)	Rolling Circum. (in.)	Recommended Rim	Acceptable Rims					Min. Dual / Triple Spacing (in.)	75% internal volume (gal.)	Tread depth (32nd in.)			
20.9	76.8	35.4	229.6	DW18L	DD18 W18L					26.4	143.8	71			
Psi	15	19	23	28	32	33	35	36	38	39	41	42	46	51	55
6 mph Cyc Duals	8490	10085	11685	13605	14330	14595	14860	15135	15400	15665					
6 mph	8795	10805	12810	14100	15060	15375	15585	15805	16015	16225					
15 mph	7340	8720	10095	10780	11320	11475	11630								
20 mph	7075	8410	9735	10395	10915	11065	11210								
30 mph	6615	7860	9095	9710	10195	10340	10470								
20 mph Dual	6230	7395	8565	9150	9600	9735	9865								

Rim Size (inch)		Description								MSPN (CAI)					
42		620/70 R42 166A8/166B TL (Textile belted)								15145 (100268)					
Section Width	Overall Diam. (in.)	Loaded Radius (in.)	Rolling Circum. (in.)	Recommended Rim	Acceptable Rims					Min. Dual / Triple Spacing (in.)	75% internal volume (gal.)	Tread depth (32nd in.)			
25.2	77.2	34.8	230.6	DW20B (A)	DW18L MW20B (A)					31.5	173.7	71			
Psi	15	19	23	28	32	33	35	36	38	39	41	42	46	51	55
6 mph Cyc Dual	8995	10750	12500	14255	15500	15830	16160	16490	16820	17150	17485				
6 mph	9015	10780	12535	14295	15545	15875	16205	16535	16865	17195	17525				
25 mph	7165	8545	9920	10580	11245	11465	11685								
30 mph	7165	8545	9920	10580	11245	11465	11685								
20 mph Dual	6745	8045	9350	9965	10595	10790	11000								

***IMPORTANT:**

The inflation pressure must always be appropriate for the load per tire, the speed of travel and the work to be done. Our recommendations above are provided subject to changes made after the date of publication of these tables. Technical data is subject to change without prior notice.

- When using single tire configuration:
 - add 6 psi for use on slopes of more than 20%
 - add 6 psi for intense road use exceeding 50%
- 6, 10 or 20 mph cyclic load, use in the field only, travel with full load not to exceed 1 mile.



SPRAYBIB®

HIGH LOAD CAPACITY FOR SPRAYERS

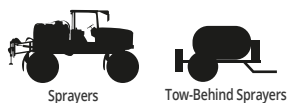

EXCEPTIONAL LOAD CAPACITY

- +16% load vs IF Tire for the same pressure¹
- 40% more load carrying capacity versus standard radial



SOIL PROTECTION

- 20% lower air pressure for the same load as an IF tire¹
- VF Very High Flexion Tire - carries same loads at 40% less pressure than standard radial tire
- Up to 4% yield gains using Michelin Ultraflex tires²



COMFORT

- Low pressures through Michelin Ultraflex sidewalls allows for superior driver comfort
- Maximum stability at speeds up to 40 mph (43 mph for CFO tires)



LONG TIRE LIFE

- Optimized tread design and increased stubble resistance
- Reinforced sidewalls and bead zones offer increased casing endurance and tread life



VF Very High Flexion



(1) Internal test 2015 (Ladoux - France)
(2) Harper Adams University 2014/2016

SIZES

VF 420/90 R34 CFO 174D/170E TL	VF 380/90 R46 CFO 173D/169E TL	VF 480/80 R50 179D TL
VF 380/80 R38 167D TL	VF 480/80 R46 177D TL	VF 480/80 R50 CFO 179D/175E TL
VF 380/80 R38 CFO 167D/163E TL	VF 480/80 R46 CFO 177D/173E TL	VF 320/90 R54 168D TL
VF 320/90 R42 163D TL	VF 320/90 R50 166D TL	VF 320/90 R54 CFO 168D/164E TL
VF 480/80 R42 176D TL	VF 320/90 R50 CFO 166D/162E TL	VF 320/105 R 54 172D TL
VF 480/80 R42 CFO 176D/172E TL	VF 380/90 R50 175D TL	VF 380/90 R54 176D TL
VF 320/90 R46 165D TL	VF 380/90 R50 CFO 175D/171E TL	VF 380/90 R54 CFO 176D/172E TL
VF 320/90 R46 CFO 165D/161E TL	VF 420/95 R50 177D TL	
VF 380/90 R46 173D TL	VF 420/95 R50 CFO 179D/175E TL	

Tire specifications and pressure table. Load per tire in lbs.*

Rim Size (inch)		Description										MSPN (CAI)	
34		VF 420/90 R34 CFO 174D/170E TL										29015 (343695)	
Section Width	Overall Diam. (in.)	Loaded Radius (in.)	Rolling Circum. (in.)	Recommended Rim	Acceptable Rims					Min. Dual / Triple Spacing (in.)	75% internal volume (gal.)	Tread depth (32nd in.)	
16.8	63.4	28.3	188.1	DW15L	DW14L W14L					21.8	81.8		
Psi	12	16	20	25	29	33	38	42	46	51	55	59	64
10 mph Cyclic	5040	6360	7685	9005	10330	11310	12060	12810	13480	14165	14835	15555	16545
20 mph Cyclic	5040	6360	7685	9005	10330	11310	12060	12810	13480	14165	14835	15555	16545
6 mph	4885	6175	7450	8740	10020	10955	11685	12410	13075	13725	14385	15080	16040
12.5 mph	4620	5830	7045	8255	9470	10360	11055	11740	12355	12985	13605	14255	15155
30 mph	4440	5610	6780	7935	9105	9965	10625	11290	11885	12480	13075	13700	14770
40 mph	4440	5610	6780	7935	9105	9965	10625	11290	11885	12480	13075	13700	14770
43 mph	4035	5105	6160	7230	8290	9060	9665	10275	10815	11355	11895	12465	13230

Rim Size (inch)		Description										MSPN (CAI)	
38		VF 380/80 R38 167D TL [DISCONTINUED 2nd Half 2022]										93213 (352109)	
Section Width	Overall Diam. (in.)	Loaded Radius (in.)	Rolling Circum. (in.)	Recommended Rim	Acceptable Rims					Min. Dual / Triple Spacing (in.)	75% internal volume (gal.)	Tread depth (32nd in.)	
15	62.1	28.6	185.5	DW13	DW12					20.1	61	48	
Psi	12	16	20	25	29	33	38	42	46	51	55	59	64
40 mph						8155	8685	9305	9920	10340	10750	11265	12015

Rim Size (inch)		Description										MSPN (CAI)	
38		VF 380/80 R38 CFO 167D/163E TL [NEW 2nd Half 2022]										15109 (523910)	
Section Width	Overall Diam. (in.)	Loaded Radius (in.)	Rolling Circum. (in.)	Recommended Rim	Acceptable Rims					Min. Dual / Triple Spacing (in.)	75% internal volume (gal.)	Tread depth (32nd in.)	
15.0	62.4	28.4	186.1	DW13	DW12					20.1	60.8	48	
Psi	12	16	20	25	29	33	38	42	46	51	55	59	64
10 mph Cyclic	4620	5590	6560	7530	8490	9270	9790	10375	10945	11530	12105	12765	13580
20 mph Cyclic	4620	5590	6560	7530	8490	9270	9790	10375	10945	11530	12105	12765	13580
6 mph	4475	5410	6360	7295	8235	8995	9490	10055	10615	11165	11730	12370	13160
12.5 mph	4235	5125	6010	6900	7780	8500	8960	9490	10030	10560	11090	11695	12445
30 mph	4070	4925	5775	6635	7485	8170	8620	9140	9645	10165	10670	11265	12015
40 mph	4070	4925	5775	6635	7485	8170	8620	9140	9645	10165	10670	11265	12015
43 mph	3705	4485	5260	6040	6810	7440	7850	8310	8785	9250	9710	10205	10750

Rim Size (inch)		Description										MSPN (CAI)	
42		VF 320/90 R42 163D TL										44635 (920383)	
Section Width	Overall Diam. (in.)	Loaded Radius (in.)	Rolling Circum. (in.)	Recommended Rim	Acceptable Rims					Min. Dual / Triple Spacing (in.)	75% internal volume (gal.)	Tread depth (32nd in.)	
13.1	64.4	29.8	192.5	DW11	DW10					17.2	51.5	45	
Psi	12	16	20	25	29	33	38	42	46	51	55	59	64
40 mph						7275	7715	8245	8820	9235	9710	10230	10750

Rim Size (inch)		Description										MSPN (CAI)	
42		VF 480/80 R42 176D TL [DISCONTINUED 2nd Half 2022]										13814 (929553)	
Section Width	Overall Diam. (in.)	Loaded Radius (in.)	Rolling Circum. (in.)	Recommended Rim	Acceptable Rims					Min. Dual / Triple Spacing (in.)	75% internal volume (gal.)	Tread depth (32nd in.)	
19.3	72.4	32.8	215.4	DW16A	DD16 W16A					24.6	110.9	48	
Psi	12	16	20	25	29	33	38	42	46	51	55	59	64
40 mph						11465	12125	12950	13865	14770	15430		

* Refer to the notes at the end of the tables of this range

SPRAYBIB®

Tire specifications and pressure table. Load per tire in lbs.*

Rim Size (inch)		Description									MSPN (CAI)		
42		VF 480/80 R42 CFO 176D/172E TL [NEW 2nd Half 2022]									82649 (579330)		
Section Width	Overall Diam. (in.)	Loaded Radius (in.)	Rolling Circum. (in.)	Recommended Rim	Acceptable Rims					Min. Dual / Triple Spacing (in.)	75% internal volume (gal.)	Tread depth (32nd in.)	
19.0	72.6	32.8	215.9	DW16A	DD16, W16A					24.6	111.0	48	
Psi	12	16	20	25	29	33	38	42	46	51	55	59	64
10 mph Cyclic	6625	8490	10275	12050	13095	13800	14695	15675	16570	17405			
20 mph Cyclic	6625	8490	10275	12050	13095	13800	14695	15675	16570	17405			
6 mph	6425	8225	9955	11675	12700	13380	14240	15190	16050	16865			
12.5 mph	6075	7780	9415	11035	12005	12655	13460	14365	15180	15950			
30 mph	5840	7485	9050	10615	11540	12160	12940	13810	14615	15400			
40 mph	5840	7485	9050	10615	11540	12160	12940	13810	14615	15400			
43 mph	5315	6800	8235	9655	10505	11065	11785	12565	13185	13715			

Rim Size (inch)		Description									MSPN (CAI)		
46		VF 320/90 R46 165D TL [DISCONTINUED 2nd Half 2022]									18963 (684579)		
Section Width	Overall Diam. (in.)	Loaded Radius (in.)	Rolling Circum. (in.)	Recommended Rim	Acceptable Rims					Min. Dual / Triple Spacing (in.)	75% internal volume (gal.)	Tread depth (32nd in.)	
12.5	68.3	31.9	210.6	DW10						17.2	55.7	47	
Psi	12	16	20	25	29	33	38	42	46	51	55	59	64
40 mph						7715	8190	8685	9095	9710	10285	10815	11355

Rim Size (inch)		Description									MSPN (CAI)		
46		VF 320/90 R46 CFO 165D/161E TL [NEW 2nd Half 2022]									31829 (443039)		
Section Width	Overall Diam. (in.)	Loaded Radius (in.)	Rolling Circum. (in.)	Recommended Rim	Acceptable Rims					Min. Dual / Triple Spacing (in.)	75% internal volume (gal.)	Tread depth (32nd in.)	
12.2	68.5	31.8	205.1	DW10						17.2	55.7	47	
Psi	12	16	20	25	29	33	38	42	46	51	55	59	64
10 mph Cyclic	4290	5215	6140	7075	8005	8740	9250	9820	10395	10980	11575	12180	12800
20 mph Cyclic	4290	5215	6140	7075	8005	8740	9250	9820	10395	10980	11575	12180	12800
6 mph	4155	5060	5950	6855	7760	8475	8960	9525	10075	10635	11220	11815	12410
12.5 mph	3775	4595	5410	6230	7045	7705	8145	8655	9160	9665	10195	10735	11275
30 mph	3780	4595	5410	6230	7055	7705	8145	8655	9160	9680	10220	10790	11355
40 mph	3780	4595	5410	6230	7055	7705	8145	8655	9160	9680	10220	10790	11355
43 mph	3440	4190	4925	5675	6415	7010	7420	7880	8335	8795	9260	9735	10195

Rim Size (inch)		Description									MSPN (CAI)		
46		VF 380/90 R46 173D TL [DISCONTINUED 2nd Half 2022]									27358 (198604)		
Section Width	Overall Diam. (in.)	Loaded Radius (in.)	Rolling Circum. (in.)	Recommended Rim	Acceptable Rims					Min. Dual / Triple Spacing (in.)	75% internal volume (gal.)	Tread depth (32nd in.)	
15.1	72.5	33.4	217.7	DW13A	DW12A W12 W12A W13 W13A					20.1	81.4	48	
Psi	12	16	20	25	29	33	38	42	46	51	55	59	64
40 mph						9920	10615	11275	12015	12600	13005	13505	14330

* Refer to the notes at the end of the tables of this range



SPRAYBIB®

Tire specifications and pressure table. Load per tire in lbs.*

Rim Size (inch)		Description									MSPN (CAI)		
46		VF 380/90 R46 CFO 173D/169E TL									20857 (007760)		
Section Width	Overall Diam. (in.)	Loaded Radius (in.)	Rolling Circum. (in.)	Recommended Rim	Acceptable Rims					Min. Dual / Triple Spacing (in.)	75% internal volume (gal.)	Tread depth (32nd in.)	
15.2	72.6	33.3	216.7	DW13A	DW12A W12 W12A W13 W13A					20.1	81.4	48	
Psi	12	16	20	25	29	33	38	42	46	51	55	59	64
10 mph Cyclic	4960	6285	7605	8930	10250	11300	11960	12710	13450	14200	14825	15485	16315
20 mph Cyclic	4960	6285	7605	8930	10250	11300	11960	12710	13450	14200	14825	15485	16315
6 mph	4795	6085	7375	8655	9945	10915	11575	12380	13120	13780	14330	14935	15765
12.5 mph	4520	5720	6935	8135	9335	10305	10970	11685	12345	13005	13560	14130	14880
30 mph	4355	5490	6625	7760	8885	9920	10615	11275	12015	12600	13005	13505	14330
40 mph	4355	5490	6625	7760	8885	9920	10615	11275	12015	12600	13005	13505	14330
43 mph	3970	5025	6095	7155	8225	9040	9590	10230	10805	11385	11850	12290	12785

Rim Size (inch)		Description									MSPN (CAI)		
46		VF 480/80 R46 177D TL [DISCONTINUED 2nd Half 2022]									21151 (159186)		
Section Width	Overall Diam. (in.)	Loaded Radius (in.)	Rolling Circum. (in.)	Recommended Rim	Acceptable Rims					Min. Dual / Triple Spacing (in.)	75% internal volume (gal.)	Tread depth (32nd in.)	
19.1	76.5	34.8	228	DW16A (L)	DW15L DW16B W16A					24.6	118.7	48	
Psi	12	16	20	25	29	33	38	42	46	51	55	59	64
40 mph					12050	12600	13395	14310	15210	15875			

Rim Size (inch)		Description									MSPN (CAI)		
46		VF 480/80 R46 CFO 177D/173E TL [NEW 2nd Half 2022]									92012 (325824)		
Section Width	Overall Diam. (in.)	Loaded Radius (in.)	Rolling Circum. (in.)	Recommended Rim	Acceptable Rims					Min. Dual / Triple Spacing (in.)	75% internal volume (gal.)	Tread depth (32nd in.)	
19.1	76.5	34.8	227.9	DW16A(L)	DW15L, DW16B, W16A					24.6	118.7	48	
Psi	12	16	20	25	29	33	38	42	46	51	52	59	64
10 mph Cyclic	7110		10935		13700	14440	15365	16390	17240	18010	18265		
20 mph Cyclic	7110		10935		13700	14440	15365	16390	17240	18010	18265		
6 mph	6890		10595		13285	14000	14890	15885	16710	17460	17705		
12.5 mph	6515		10020		12555	13230	14075	15025	15795	16500	16735		
30 mph	6270		9635		12070	12720	13535	14450	15200	15875	16095		
40 mph	6270		9635		12070	12720	13535	14450	15200	15875	16095		
43 mph	5700		8765		10990	11575	12325	13140	13725	14175	14330		

Rim Size (inch)		Description									MSPN (CAI)		
50		VF 320/90 R50 166D TL									99896 (946508)		
Section Width	Overall Diam. (in.)	Loaded Radius (in.)	Rolling Circum. (in.)	Recommended Rim	Acceptable Rims					Min. Dual / Triple Spacing (in.)	75% internal volume (gal.)	Tread depth (32nd in.)	
13	72.6	34	217.8	DW11	DW10 W10 W11					17.2	63.4	47	
Psi	12	16	20	25	29	33	38	42	46	51	55	59	64
40 mph						8155	8545	9030	9645	10065	10570	11120	11685

* Refer to the notes at the end of the tables of this range

SPRAYBIB®

Tire specifications and pressure table. Load per tire in lbs.*

Rim Size (inch)		Description										MSPN (CAI)		
50		VF 320/90 R50 CFO 166D/162E TL [NEW 2nd Half 2022]										21940 (840040)		
Section Width	Overall Diam. (in.)	Loaded Radius (in.)	Rolling Circum. (in.)	Recommended Rim	Acceptable Rims						Min. Dual / Triple Spacing (in.)	75% internal volume (gal.)	Tread depth (32nd in.)	
12.7	72.8	34.1	218.3	DW11	DW10, W10, W11						17.2	59.6	47	
Psi	12	16	20	25	29	33	38	42	46	51	55	59	64	
10 mph Cyclic	4620	5565	6505	7440	8390	9205	9780	10360	10955	11510	12115	12755	13395	
20 mph Cyclic	4620	5565	6505	7440	8390	9205	9780	10360	10955	11510	12115	12755	13395	
6 mph	4475	5390	6305	7220	8135	8930	9480	10040	10625	11145	11740	12355	12985	
12.5 mph	3775	4595	5410	6230	7045	7750	8235	8720	9230	9690	10195	10735	11275	
30 mph	4070	4895	5730	6560	7395	8115	8620	9125	9655	10140	10650	11165	11685	
40 mph	4070	4895	5730	6560	7395	8115	8620	9125	9655	10140	10650	11165	11685	
43 mph	3705	4465	5215	5975	6725	7385	7835	8310	8785	9225	9645	10065	10470	

Rim Size (inch)		Description										MSPN (CAI)		
50		VF 380/90 R50 175D TL [DISCONTINUED 2nd Half 2022]										28608 (722276)		
Section Width	Overall Diam. (in.)	Loaded Radius (in.)	Rolling Circum. (in.)	Recommended Rim	Acceptable Rims						Min. Dual / Triple Spacing (in.)	75% internal volume (gal.)	Tread depth (32nd in.)	
15.1	76.8	35.6	229.8	DW13B	DW12A W12A W12B W13A W13B						20.1	87	48	
Psi	12	16	20	25	29	33	38	42	46	51	55	59	64	
40 mph						10340	10915	11605	12345	13005	13560	14220	15210	

Rim Size (inch)		Description										MSPN (CAI)		
50		VF 380/90 R50 CFO 175D/171E TL [NEW 2nd Half 2022]										16655 (340728)		
Section Width	Overall Diam. (in.)	Loaded Radius (in.)	Rolling Circum. (in.)	Recommended Rim	Acceptable Rims						Min. Dual / Triple Spacing (in.)	75% internal volume (gal.)	Tread depth (32nd in.)	
15.1	76.8	35.5	229.7	DW13B	DW12A, W12A, W12B, W13A, W13B						20.1	86.9	48	
Psi	12	16	20	25	29	33	38	42	46	51	55	59	64	
10 mph Cyclic	5300		8180			11760	12465	13285	14100	14890	15675	16470	17265	
20 mph Cyclic	5300		8180			11760	12465	13285	14100	14890	15675	16470	17265	
6 mph	5135		7925			11410	12090	12875	13670	14440	15200	15960	16735	
12.5 mph	4860		7495			10780	11420	12170	12920	13645	14375	15090	15820	
30 mph	4675		7200			10360	10990	11705	12425	13120	13825	14515	15210	
40 mph	4675		7200			10360	10990	11705	12425	13120	13825	14515	15210	
43 mph	4245		6560			9435	10010	10660	11310	11870	12435	12995	13560	

Rim Size (inch)		Description										MSPN (CAI)		
50		VF 420/95 R50 177D TL [DISCONTINUED 2nd Half 2022]										82545 (085405)		
Section Width	Overall Diam. (in.)	Loaded Radius (in.)	Rolling Circum. (in.)	Recommended Rim	Acceptable Rims						Min. Dual / Triple Spacing (in.)	75% internal volume (gal.)	Tread depth (32nd in.)	
16.7	80.8	36.9	240.9	DW14B (A)	DW13B (A) W13B (A) W14B (A)						21.8	116.1	48	
Psi	12	16	20	25	29	33	38	42	46	51	55	59	64	
40 mph						11830	12555	13395	14310	15210	15875			

* Refer to the notes at the end of the tables of this range



SPRAYBIB®

Tire specifications and pressure table. Load per tire in lbs.*

Rim Size (inch)		Description										MSPN (CAI)	
50		VF 420/95 R50 CFO 179D/175E TL [NEW 2nd Half 2022]										53951 (358639)	
Section Width	Overall Diam. (in.)	Loaded Radius (in.)	Rolling Circum. (in.)	Recommended Rim	Acceptable Rims						Min. Dual / Triple Spacing (in.)	75% internal volume (gal.)	Tread depth (32nd in.)
16.5	81.1	37.1	241.9	DW14B(A)	DW13B (A), W13B (A), W14B (A)						21.8	116.1	48
Psi	12	16	20	25	29	33	38	42	46	51	55	59	64
10 mph Cyclic	6755	8685	10550	12400	13505	14220	15135	16150	17085	17970	18740		
20 mph Cyclic	6755	8685	10550	12400	13505	14220	15135	16150	17085	17970	18740		
6 mph	6550	8435	10230	12015	13075	13780	14670	15655	16555	17415	18165		
12.5 mph	6195	7970	9665	11365	12370	13030	13865	14795	15640	16460	17175		
30 mph	5950	7660	9290	10925	11895	12535	13340	14230	15045	15830	16590		
40 mph	5950	7660	9290	10925	11895	12535	13340	14230	15035	15795	16570		
43 mph	5425	6965	8455	9945	10825	11410	12135	12950	13680	14375	14915		

Rim Size (inch)		Description										MSPN (CAI)	
50		VF 480/80 R50 179D TL [DISCONTINUED 2nd Half 2022]										50045 (431251)	
Section Width	Overall Diam. (in.)	Loaded Radius (in.)	Rolling Circum. (in.)	Recommended Rim	Acceptable Rims						Min. Dual / Triple Spacing (in.)	75% internal volume (gal.)	Tread depth (32nd in.)
19.1	80.5	36.8	240.2	DW16A(L)	DW15B (A) DW15L DW16B W15B (A) W16B						24.6	126.6	48
Psi	12	16	20	25	29	33	38	42	46	51	55	59	64
40 mph					12535	13305	14200	15145	16095	16845			

Rim Size (inch)		Description										MSPN (CAI)	
50		VF 480/80 R50 CFO 179D/175E TL [NEW 2nd Half 2022]										50314 (162735)	
Section Width	Overall Diam. (in.)	Loaded Radius (in.)	Rolling Circum. (in.)	Recommended Rim	Acceptable Rims						Min. Dual / Triple Spacing (in.)	75% internal volume (gal.)	Tread depth (32nd in.)
18.9	80.5	36.8	240.1	DW16A(L)	DW15B(A), DW15L, DW16B, W15B, W16B						24.6	126.6	48
Psi	12	16	20	25	29	33	38	42	46	51	52	59	64
10 mph Cyclic	7330		11330		14295	15070	16040	17110	18100	19070	19390		
20 mph Cyclic	7330		11330		14295	15070	16040	17110	18100	19070	19390		
6 mph	7100		10990		13855	14605	15545	16580	17550	18485	18795		
12.5 mph	6715		10385		13095	13800	14685	15665	16590	17470	17770		
30 mph	6460		9985		12600	13270	14120	15070	15950	16800	17085		
40 mph	6460		9985		12600	13270	14120	15070	15950	16800	17085		
43 mph	5875		9085		11465	12080	12855	13715	14405	15015	15210		

Rim Size (inch)		Description										MSPN (CAI)	
54		VF 320/90 R54 168D TL [DISCONTINUED 2nd Half 2022]										45449 (044008)	
Section Width	Overall Diam. (in.)	Loaded Radius (in.)	Rolling Circum. (in.)	Recommended Rim	Acceptable Rims						Min. Dual / Triple Spacing (in.)	75% internal volume (gal.)	Tread depth (32nd in.)
12.9	76.8	35.8	230	DW11	DW10 W10 W11						17.2	63.4	45
Psi	12	16	20	25	29	33	38	42	46	51	55	59	64
40 mph						8410	8960	9580	10195	10615	11145	11750	12345

* Refer to the notes at the end of the tables of this range

SPRAYBIB®

Tire specifications and pressure table. Load per tire in lbs.*

Rim Size (inch)		Description										MSPN (CAI)		
54		VF 320/90 R54 CFO 168D/164E TL [NEW 2nd Half 2022]										01344 (666915)		
Section Width	Overall Diam. (in.)	Loaded Radius (in.)	Rolling Circum. (in.)	Recommended Rim	Acceptable Rims						Min. Dual / Triple Spacing (in.)	75% internal volume (gal.)	Tread depth (32nd in.)	
12.7	77.0	35.8	230.5	DW11	DW10, W10, W11						17.2	63.4	46	
Psi	12	16	20	25	29	33	38	42	46	51	55	59	64	
10 mph Cyclic	4575	5610	6645	7685	8710	9535	10085	10715	11355	11980	12630	13305	13965	
20 mph Cyclic	4575	5610	6645	7685	8710	9535	10085	10715	11355	11980	12630	13305	13965	
6 mph	4440	5445	6450	7450	8445	9250	9780	10395	11000	11620	12245	12885	13535	
12.5 mph	3775	4595	5410	6230	7045	7705	8145	8655	9160	9665	10195	10735	11280	
30 mph	4035	4950	5855	6770	7685	8410	8895	9445	10000	10550	11145	11740	12345	
40 mph	4035	4950	5855	6770	7685	8410	8895	9445	10000	10550	11145	11740	12345	
43 mph	3670	4495	5325	6160	6990	7650	8090	8600	9095	9600	10085	10550	11025	

Rim Size (inch)		Description										MSPN (CAI)		
54		VF 320/105 R 54 172D TL [NEW 2nd Half 2022]										48439 (624140)		
Section Width	Overall Diam. (in.)	Loaded Radius (in.)	Rolling Circum. (in.)	Recommended Rim	Acceptable Rims						Min. Dual / Triple Spacing (in.)	75% internal volume (gal.)	Tread depth (32nd in.)	
13.3	79.8	36.9	238.8	DW11	DW10							76.3	48	
Psi	12	16	20	25	29	33	38	42	46	51	55	59	64	
40 mph	4465	5620	6725	7770	8765	9515	10065	10690	11355	11850	12400	13060	13890	

Rim Size (inch)		Description										MSPN (CAI)		
54		VF 380/90 R54 176D TL [DISCONTINUED 2nd Half 2022]										47923 (816598)		
Section Width	Overall Diam. (in.)	Loaded Radius (in.)	Rolling Circum. (in.)	Recommended Rim	Acceptable Rims						Min. Dual / Triple Spacing (in.)	75% internal volume (gal.)	Tread depth (32nd in.)	
15.1	80.7	37.4	241.4	DW13A	W12A						20.1	92.3	47	
Psi	12	16	20	25	29	33	38	42	46	51	55	59	64	
40 mph						10890	11440	12060	12675	13295	13920	14660	15655	

Rim Size (inch)		Description										MSPN (CAI)		
54		VF 380/90 R54 CFO 176D/172E TL [NEW 2nd Half 2022]										31205 (019737)		
Section Width	Overall Diam. (in.)	Loaded Radius (in.)	Rolling Circum. (in.)	Recommended Rim	Acceptable Rims						Min. Dual / Triple Spacing (in.)	75% internal volume (gal.)	Tread depth (32nd in.)	
15.1	80.7	37.3	241.3	DW13A	W12A						20.1	92.3	47	
Psi	12	15	20	26	32	33	38	42	46	51	55	59	64	
10 mph Cyclic	5665	6715	8665	10470	12080	12260	12995	13845	14695	15465	16225	17000	17770	
20 mph Cyclic	5665	6715	8665	10470	12080	12260	12995	13845	14695	15465	16225	17000	17770	
6 mph	5490	6505	8390	10155	11705	11870	12590	13415	14240	14990	15730	16470	17220	
12.5 mph	5190	6150	7935	9600	11070	11235	11905	12690	13460	14165	14870	15575	16280	
30 mph	4995	5910	7630	9225	10650	10805	11440	12190	12940	13625	14295	14970	15655	
40 mph	4995	5910	7630	9225	10650	10805	11440	12190	12940	13625	14295	14970	15655	
43 mph	4540	5380	6945	8400	9690	9835	10415	11100	11775	12300	12830	13360	13890	

***IMPORTANT:**

The inflation pressure must always be appropriate for the load per tire, the speed of travel and the work to be done. Our recommendations above are provided subject to changes made after the date of publication of these tables. Technical data is subject to change without prior notice.

- For plowing and other field applications subject to high torque use the 20 mph line.

- When using single tire configuration:
 - add 6 psi for use on slopes of more than 20%
 - add 6 psi for intense road use exceeding 50%
- **6 mph LT (Low Torque) (max speed 6 mph).
- FRT: Free Rolling Tire





AGRIBIB® ROW CROP

**SPECIALLY DESIGNED TO PROVIDE
EXCELLENT TRACTION FOR ROW CROP
TRACTORS AND IMPLEMENTS**



REDUCED TIRE WIDTH FOR SPECIALTY APPLICATIONS

Farmers who are reducing spacing to increase yields or accommodate specialty crops such as vegetables need tires with less width, exceptional load capacity and long life.



TRACTION

- Excellent traction and lateral stability
- Robust crown and deep tread bars
- Extra-deep 40° lugs provide impressive traction and excellent directional control



SERVICE LIFE

- Deep R1W lug design for a long tread life
- Additional lugs promote slow tire wear and long service life under heavy loads at road speeds
- Stabilizing crown belts reduce lug movement, ensuring smooth even wear



ROBUSTNESS

- An extra-strong but super-flexible casing, which offers a large footprint and surprising ride comfort, has excellent durability to carry extra-heavy loads



IF Increased Flexion



IF Tires Only



SIZES

320/85 R38 143A8/143B TL

IF 320/85 R38 151A8/151B TL

320/90 R42 147A8/147B TL

340/85 R46 150A8/150B TL

380/90 R46 157A8/157B TL

IF 380/90 R46 165A8/165B TL

320/90 R50 150A8/150B TL

IF 320/90 R50 158A8/158B TL

380/90 R50 151A8/151B TL

IF 380/90 R50 167A8/167B TL

320/90 R54 151A8/151B TL

IF 320/90 R54 159A8/159B TL

AGRIBIB® ROW CROP

Tire specifications and pressure table. Load per tire in lbs.*

Rim Size (inch)		Description										MSPN (CAI)				
38		320/85 R38 143A8/143B TL [DISCONTINUED]										50528 (758001)				
Section Width	Overall Diam. (in.)	Loaded Radius (in.)	Rolling Circum. (in.)	Recommended Rim	Acceptable Rims						Min. Dual / Triple Spacing (in.)	75% internal volume (gal.)	Tread depth (32nd in.)			
12.4	59.4	27.5	177.7	W10	DW10A, DW11A, W11						17.1	44.8	53			
Psi	17	20	23	26	29	32	35	38	41	44	46	49	52	55	58	
6 mph Cyc				5135	5555	5975	6395	6810	7065	7310	7560	7805	8155	8510	8765	9015
15 mph Cyc	4165	4575	4980	5205	5425	5645	5865	6130	6395	6660	6925	7120	7320			
20 mph Cyc	3900	4275	4650	4860	5070	5280	5490	5745	5985	6240	6480	6670	6855			
15 mph	3790	4155	4520	4730	4925	5135	5335	5580	5820	6065	6305	6480	6660			
20 mph	3660	4010	4365	4565	4750	4950	5135	5380	5610	5855	6085	6260	6435			
30 mph	3415	3750	4080	4265	4440	4630	4805	5025	5245	5455	5675	5840	6010			

Rim Size (inch)		Description										MSPN (CAI)			
38		IF 320/85 R38 151A8/151B TL										20864 (351097)			
Section Width	Overall Diam. (in.)	Loaded Radius (in.)	Rolling Circum. (in.)	Recommended Rim	Acceptable Rims						Min. Dual / Triple Spacing (in.)	75% internal volume (gal.)	Tread depth (32nd in.)		
13	59.3	27.4	177	DW11A	DW10A, W10, W11						17.2	44.8	52		
Psi	17	20	23	26	29	32	35	38	41	44	46	49	52	55	58
6 mph	4465	4960	5455	5710	5950	6150	6340	6645	6945	7220	7495	7750	7990	8190	8380
12.5 mph	4355	4850	5345	5600	5840	6040	6230	6535	6835	7110	7385	7640	7880	8045	8210
20 mph	4190	4665	5125	5380	5620	5820	6010	6285	6560	6835	7110	7330	7550	7750	7935
30 mph	4025	4495	4960	5180	5400	5600	5785	6065	6340	6590	6835	7055	7275	7440	7605

Rim Size (inch)		Description										MSPN (CAI)				
42		320/90 R42 147A8/147B TL										64720 (425361)				
Section Width	Overall Diam. (in.)	Loaded Radius (in.)	Rolling Circum. (in.)	Recommended Rim	Acceptable Rims						Min. Dual / Triple Spacing (in.)	75% internal volume (gal.)	Tread depth (32nd in.)			
12.3	64.5	30.1	193.2	DW10L	W10L W9L						17.1	51.9	53			
Psi	17	20	23	26	29	32	35	38	41	44	46	49	52	55	58	
6 mph Cyc				6285	6670	7045	7430	7805	8045	8290	8520	8765	9180	9590	9875	10165
15 mph Cyc	4575	5060	5535	5785	6040	6285	6535	6855	7175	7485	7805	8035	8265			
20 mph Cyc	4275	4905	5535	5675	5820	5965	6105	6405	6700	6990	7285	7505	7725			
15 mph	4165	4610	5050	5280	5500	5730	5950	6240	6525	6810	7100	7320	7530			
20 mph	4010	4430	4850	5070	5290	5510	5730	6010	6285	6560	6835	7045	7255			
30 mph	3750	4145	4540	4750	4950	5160	5355	5620	5875	6140	6395	6590	6780			

Rim Size (inch)		Description										MSPN (CAI)				
46		340/85 R46 150A8/150B TL (13.6 R46)										94547 (846786)				
Section Width	Overall Diam. (in.)	Loaded Radius (in.)	Rolling Circum. (in.)	Recommended Rim	Acceptable Rims						Min. Dual / Triple Spacing (in.)	75% internal volume (gal.)	Tread depth (32nd in.)			
13.3	68.8	31.9	205.8	W12	DW10A W10 W12A						18.2	59.4	52			
Psi	17	20	23	26	29	32	35	38	41	44	46	49	52	55	58	
6 mph Cyc				6130	6670	7200	7740	8265	8600	8930	9260	9590	10010	10430	10760	11090
15 mph Cyc	4980	5500	6020	6295	6570	6845	7120	7465	7795	8135	8465	8740	9015			
20 mph Cyc	4650	5135	5620	5885	6140	6405	6660	6980	7285	7605	7915	8170	8420			
15 mph	4520	5005	5490	5745	5985	6240	6480	6790	7100	7410	7715	7960	8200			
20 mph	4365	4830	5290	5535	5775	6020	6260	6560	6845	7145	7430	7660	7895			
30 mph	4080	4510	4940	5170	5390	5620	5840	6120	6395	6670	6945	7165	7385			

* Refer to the notes at the end of the tables of this range

AGRIBIB® ROW CROP

Tire specifications and pressure table. Load per tire in lbs.*

Rim Size (inch)		Description										MSPN (CAI)			
46		380/90 R46 157A8/157B TL (14.9 R46) [DISCONTINUED]										38865 (799905)			
Section Width	Overall Diam. (in.)	Loaded Radius (in.)	Rolling Circum. (in.)	Recommended Rim	Acceptable Rims					Min. Dual / Triple Spacing (in.)	75% internal volume (gal.)	Tread depth (32nd in.)			
15.8	73.4	34.1	219.8	W13A	DW13 DW13A W12 W12A W13					20.0	81.4	58			
Psi	17	20	23	26	29	32	35	38	41	44	46	49	52	55	58
6 mph Cyc			7605	8245	8885	9525	10165	10560	10955	11355	11750	12280	12810	13230	13645
15 mph Cyc	6195	6865	7540	7850	8145	8455	8750	9170	9590	10010	10430	10760	11090		
20 mph Cyc	5775	6405	7035	7320	7605	7895	8180	8575	8960	9360	9745	10055	10360		
15 mph	5620	6240	6855	7130	7410	7685	7960	8345	8720	9105	9480	9790	10095		
20 mph	5425	6020	6615	6880	7145	7410	7670	8045	8410	8785	9150	9435	9720		
30 mph	5070	5620	6175	6425	6670	6925	7165	7505	7860	8200	8545	8820	9095		

Rim Size (inch)		Description										MSPN (CAI)			
46		IF 380/90 R46 165A8/165B TL										84037 (120462)			
Section Width	Overall Diam. (in.)	Loaded Radius (in.)	Rolling Circum. (in.)	Recommended Rim	Acceptable Rims					Min. Dual / Triple Spacing (in.)	75% internal volume (gal.)	Tread depth (32nd in.)			
15.2	72.5	33.5	217	DW13A	DW12A, DW13, W12, W12A, W13, W13A					20.1	81.4	58			
Psi	17	20	23	26	29	32	35	38	41	44	46	49	52	55	58
6 mph	6615	7365	8100	8490	8875	9150	9425	9865	10305	10780	11245	11550	11850	12180	12510
12.5 mph	6505	7255	7990	8355	8710	8960	9205	9680	10140	10580	11025	11330	11630	11940	12235
20 mph	6230	6945	7660	8025	8380	8630	8875	9315	9755	10175	10580	10890	11190	11495	11795
30 mph	6010	6700	7385	7715	8045	8300	8545	8960	9370	9790	10195	10470	10750	11055	11355

Rim Size (inch)		Description										MSPN (CAI)			
50		320/90 R50 150A8/150B TL [DISCONTINUED]										95098 (130813)			
Section Width	Overall Diam. (in.)	Loaded Radius (in.)	Rolling Circum. (in.)	Recommended Rim	Acceptable Rims					Min. Dual / Triple Spacing (in.)	75% internal volume (gal.)	Tread depth (32nd in.)			
12.4	72.7	33.9	218.1	W10	DW10A W10A					17.1	59.6	49			
Psi	17	20	23	26	29	32	35	38	41	44	46	49	52	55	58
6 mph Cyc			6130	6670	7200	7740	8265	8600	8930	9260	9590	10010	10430	10760	11090
15 mph Cyc	4980	5500	6020	6295	6570	6845	7120	7465	7795	8135	8465	8740	9015		
20 mph Cyc	4650	5135	5620	5885	6140	6405	6660	6980	7285	7605	7915	8170	8420		
15 mph	4520	5005	5490	5745	5985	6240	6480	6790	7100	7410	7715	7960	8200		
20 mph	4365	4830	5290	5535	5775	6020	6260	6560	6845	7145	7430	7660	7895		
30 mph	4080	4510	4940	5170	5390	5620	5840	6120	6395	6670	6945	7165	7385		

Rim Size (inch)		Description										MSPN (CAI)			
50		IF 320/90 R50 158A8/158B TL										00912 (125798)			
Section Width	Overall Diam. (in.)	Loaded Radius (in.)	Rolling Circum. (in.)	Recommended Rim	Acceptable Rims					Min. Dual / Triple Spacing (in.)	75% internal volume (gal.)	Tread depth (32nd in.)			
13	73.1	34.1	218.3	DW11	DW10A, DW11, W10, W10A, W11					17.2	59.6	49			
Psi	17	20	23	26	29	32	35	38	41	44	46	49	52	55	58
6 mph	5400	6010	6615	6925	7220	7475	7715	8080	8435	8765	9095	9405	9700	10010	10305
12.5 mph	5290	5875	6450	6780	7110	7330	7550	7915	8265	8600	8930	9235	9535	9845	10140
20 mph	5070	5655	6230	6535	6835	7055	7275	7640	7990	8300	8600	8875	9150	9460	9755
30 mph	4905	5455	6010	6285	6560	6780	7000	7330	7660	7970	8265	8545	8820	9095	9370

* Refer to the notes at the end of the tables of this range

AGRIBIB® ROW CROP

Tire specifications and pressure table. Load per tire in lbs.*

Rim Size (inch)		Description										MSPN (CAI)			
50		380/90 R50 151A8/151B TL [DISCONTINUED]										15852 (036849)			
Section Width	Overall Diam. (in.)	Loaded Radius (in.)	Rolling Circum. (in.)	Recommended Rim	Acceptable Rims						Min. Dual / Triple Spacing (in.)	75% internal volume (gal.)	Tread depth (32nd in.)		
15.5	76.2	35.9	228.9	DW13A	DW12A W12A W13A						20.0	87	59		
Psi	17	20	23	26	29	32	35	38	41	44	46	49	52	55	58
6 mph Cyc			7805	8695	9590	10040	10505	10955	11410						
15 mph Cyc	6350	7075	7805	8180	8545	8920	9280								
20 mph Cyc	5930	6615	7285	7640	7980	8335	8675								
15 mph	5775	6435	7100	7440	7770	8115	8445								
20 mph	5565	6205	6835	7165	7485	7815	8135								
30 mph	5205	5800	6395	6700	7000	7310	7605								

Rim Size (inch)		Description										MSPN (CAI)			
50		IF 380/90 R50 167A8/167B TL										88459 (212359)			
Section Width	Overall Diam. (in.)	Loaded Radius (in.)	Rolling Circum. (in.)	Recommended Rim	Acceptable Rims						Min. Dual / Triple Spacing (in.)	75% internal volume (gal.)	Tread depth (32nd in.)		
15.6	76.9	35.6	230	DW13A	DW12A, W12A, W13A						20.1	87	59		
Psi	17	20	23	26	29	32	35	38	41	44	46	49	52	55	58
6 mph	7055	7715	8380	8905	9425	9735	10030	10470	10915	11385	11850	12180	12510	12875	13230
12.5 mph	6890	7550	8210	8710	9205	9515	9810	10250	10690	11165	11630	11940	12235	12600	12950
20 mph	6670	7310	7935	8410	8875	9180	9480	9900	10305	10750	11190	11495	11795	12160	12510
30 mph	6395	7000	7605	8080	8545	8820	9095	9515	9920	10340	10750	11055	11355	11685	12015

Rim Size (inch)		Description										MSPN (CAI)			
54		320/90 R54 151A8/151B TL [DISCONTINUED]										96185 (272304)			
Section Width	Overall Diam. (in.)	Loaded Radius (in.)	Rolling Circum. (in.)	Recommended Rim	Acceptable Rims						Min. Dual / Triple Spacing (in.)	75% internal volume (gal.)	Tread depth (32nd in.)		
12.4	76.8	36	230.4	W10	DW11 W11						17.1	63.4	49		
Psi	17	20	23	26	29	32	35	38	41	44	46	49	52	55	58
6 mph Cyc			6460	6980	7485	8005	8510	8865	9215	9570	9920	10340	10760	11090	11420
15 mph Cyc	5245	5800	6350	6590	6835	7075	7320	7685	8035	8400	8750	9015	9280		
20 mph Cyc	4895	5410	5930	6160	6395	6625	6855	7185	7520	7850	8180	8420	8665		
15 mph	4760	5270	5775	5995	6215	6435	6660	6990	7310	7640	7960	8200	8445		
20 mph	4610	5095	5580	5800	6010	6230	6435	6745	7055	7365	7670	7905	8135		
30 mph	4300	4750	5205	5400	5610	5810	6010	6295	6590	6880	7165	7385	7605		

Rim Size (inch)		Description										MSPN (CAI)			
54		IF 320/90 R54 159A8/159B TL										59155 (467712)			
Section Width	Overall Diam. (in.)	Loaded Radius (in.)	Rolling Circum. (in.)	Recommended Rim	Acceptable Rims						Min. Dual / Triple Spacing (in.)	75% internal volume (gal.)	Tread depth (32nd in.)		
12.7	76.7	36	230.2	DW11	DW10, W10, W11						17.2	63.4	49		
Psi	17	20	23	26	29	32	35	38	41	44	46	49	52	55	58
6 mph	5620	6260	6890	7220	7550	7805	8045	8435	8820	9150	9480	9810	10140	10395	10635
12.5 mph	5510	6120	6725	7055	7385	7640	7880	8265	8655	8985	9315	9625	9920	10175	10415
20 mph	5290	5895	6505	6810	7110	7365	7605	7970	8320	8655	8985	9290	9590	9810	10030
30 mph	5125	5675	6230	6535	6835	7090	7330	7660	7990	8320	8655	8930	9205	9425	9645

***IMPORTANT:**

The inflation pressure must always be appropriate for the load per tire, the speed of travel and the work to be done. Our recommendations above are provided subject to changes made after the date of publication of these tables. Technical data is subject to change without prior notice.

• For plowing and other field applications subject to high torque use the 20 mph line.

- When using single tire configuration:
 - add 6 psi for use on slopes of more than 20%
 - add 6 psi for intense road use exceeding 50%
- **6 mph LT (Low Torque) (max speed 6 mph).
- FRT: Free Rolling Tire



TRAILXBIB®

ENHANCED PERFORMANCE FOR SLURRY WAGONS, SPREADERS AND TRAILERS

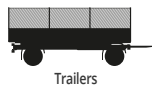

OUTSTANDING ENDURANCE

- New VF casing designed for robustness and low pressure impact
- Steel belted and extra rubber between the lugs for puncture and excellent aggression resistance



SELF-CLEANING TREAD DESIGN

- Specific tread pattern design from blocks to lugs
- Wide & divergent inner lugs, with no "closed" areas



DESIGNED FOR A LONG TIRE LIFE

- Limited scrub thanks to high clearance angle
- More rubber to be worn
- Notched lugs to improve flexibility and flattening to improve regular wear



LOW SOIL COMPACTION

- VF MICHELIN Ultraflex Technology for low soil compaction and optimized yields
- Rounded shoulders



AIR SYSTEMS 
READY

Compatible with Central Tire Inflation Systems

SIZES

VF 500/60 R22.5 160D IMP TL
VF 560/60 R22.5 166D IMP TL
VF 600/50 R22.5 164D IMP TL
VF 710/45 R22.5 170D IMP TL
VF 600/55 R26.5 170D IMP TL

VF 650/55 R26.5 174D IMP TL
VF 650/65 R26.5 179D IMP TL
VF 600/60 R30.5 175D IMP TL
VF 710/50 R26.5 176D IMP TL
VF 650/65 R30.5 181D IMP TL

VF 710/50 R30.5 178D IMP TL
VF 750/60 R30.5 187D IMP TL
VF 850/50 R30.5 188D IMP TL

TRAILXBIB®

Tire specifications and pressure table. Load per tire in lbs.*

Rim Size (inch)		Description									MSPN (CAI)	
22.5		VF 500/60 R22.5 160D IMP TL									02997 (229116)	
Section Width	Overall Diam. (in.)	Loaded Radius (in.)	Rolling Circum. (in.)	Recommended Rim	Acceptable Rims					Min. Dual / Triple Spacing (in.)	75% internal volume (gal.)	Tread depth (32nd in.)
19.7	46.2	19.4	135.2	AG16.00 (H2)	15.00,16.00, 17.00					25.7	54.3	25
Psi	12	13	15	17	22	26	30	35	39	44	46	
6 mph	6890	7350	7815	8750	10140	11220	12300	13380	14460	15545	16260	
15 mph	6120	6535	6955	7780	9040	10000	10970	11925	12885	13855	14495	
25 mph	5400	5765	6130	6845	7935	8795	9645	10505	11365	12215	12785	
30 mph	4905	5235	5565	6230	7220	8005	8775	9555	10330	11110	11630	
40 mph	4190	4475	4750	5325	6175	6835	7495	8155	8820	9480	9920	

Rim Size (inch)		Description									MSPN (CAI)	
22.5		VF 560/60 R22.5 166D IMP TL									41626 (103824)	
Section Width	Overall Diam. (in.)	Loaded Radius (in.)	Rolling Circum. (in.)	Recommended Rim	Acceptable Rims					Min. Dual / Triple Spacing (in.)	75% internal volume (gal.)	Tread depth (32nd in.)
21.3	48.9	20	142.2	AG16.00 (H2)	16.00, 17.00, AG18.00, AG20.00 (H2)					28.7	69.3	24
Psi	12	13	15	17	22	26	30	35	39	44	46	
6 mph	8210	8765	9370	10525	12290	14055	15320	15545	17085	18520	19180	
15 mph	7275	7825	8320	9370	10915	12510	13670	13835	15210	16480	17085	
25 mph	6450	6890	7385	8265	9645	11025	12070	12235	13450	14550	15045	
30 mph	5840	6285	6670	7495	8765	10030	10970	11080	12180	13230	13670	
40 mph	5015	5380	5730	6450	7495	8435	9370	9480	10415	11300	11685	

Rim Size (inch)		Description									MSPN (CAI)	
22.5		VF 600/50 R22.5 164D IMP TL									04220 (414979)	
Section Width	Overall Diam. (in.)	Loaded Radius (in.)	Rolling Circum. (in.)	Recommended Rim	Acceptable Rims					Min. Dual / Triple Spacing (in.)	75% internal volume (gal.)	Tread depth (32nd in.)
24.3	46.1	19.1	134.6	AG20.00 (H2)						29.9	65.2	23
Psi	12	13	15	17	22	26	30	35	39	44	46	
6 mph	7660	8245	8830	9985	11740	12855	13975	15090	16215	17330	18080	
15 mph	6835	7350	7870	8920	10470	11465	12455	13450	14440	15430	16095	
25 mph	6010	6470	6935	7870	9260	10130	11010	11885	12765	13635	14220	
30 mph	5455	5875	6295	7120	8380	9170	9975	10770	11565	12370	12895	
40 mph	4685	5040	5390	6105	7165	7850	8530	9205	9890	10570	11025	

Rim Size (inch)		Description									MSPN (CAI)	
22.5		VF 710/45 R22.5 170D IMP TL									64711 (520302)	
Section Width	Overall Diam. (in.)	Loaded Radius (in.)	Rolling Circum. (in.)	Recommended Rim	Acceptable Rims					Min. Dual / Triple Spacing (in.)	75% internal volume (gal.)	Tread depth (32nd in.)
28.2	47.8	20.4	140.2	AG24.00 (H2)						35.8	83.8	26
Psi	12	13	15	17	22	26	30	35	39	44	46	
6 mph	9315	9920	10525	11740	13780	15820	16735	17635	19170	20700	21715	
15 mph	8265	8820	9370	10470	12290	14110	14915	15710	17055	18400	19290	
25 mph	7330	7815	8300	9260	10860	12455	13175	13890	15090	16290	17085	
30 mph	6670	7100	7530	8380	9845	11300	11940	12565	13660	14760	15485	
40 mph	5675	6050	6425	7165	8410	9645	10195	10750	11675	12610	13230	

* Refer to the notes at the end of the tables of this range



Tire specifications and pressure table. Load per tire in lbs.*

Rim Size (inch)		Description										MSPN (CAI)		
26.5		VF 600/55 R26.5 170D IMP TL										41893 (112743)		
Section Width	Overall Diam. (in.)	Loaded Radius (in.)	Rolling Circum. (in.)	Recommended Rim	Acceptable Rims						Min. Dual / Triple Spacing (in.)	75% internal volume (gal.)	Tread depth (32nd in.)	
24.6	53.2	22.4	155.9	AG20.00 (H2)							29.9	82.4	28	
Psi	12	13	15	17	22	26	30	35	39	44	46			
6 mph	8545	9160	9765	11000	12840	14405	15970	17540	19105	20670	21715			
15 mph	7605	8145	8695	9780	11410	12800	14185	15585	16975	18365	19290			
25 mph	6725	7210	7685	8640	10085	11320	12555	13790	15025	16260	17085			
30 mph	6065	6505	6945	7825	9150	10265	11385	12500	13625	14740	15485			
40 mph	5180	5555	5940	6690	7825	8775	9735	10680	11640	12590	13230			

Rim Size (inch)		Description										MSPN (CAI)		
26.5		VF 650/55 R26.5 174D IMP TL										37535 (054878)		
Section Width	Overall Diam. (in.)	Loaded Radius (in.)	Rolling Circum. (in.)	Recommended Rim	Acceptable Rims						Min. Dual / Triple Spacing (in.)	75% internal volume (gal.)	Tread depth (32nd in.)	
25.6	55.2	22.6	160.7	AG20.00 (H2)							32.5	99.4	29	
Psi	12	13	15	17	22	26	30	35	39	44	46			
6 mph	9310	10080	10845	12110	14010	15820	17685	19705	21605	23500	24225			
15 mph	8290	8975	9655	10785	12475	14085	15740	17540	19235	20920	21565			
25 mph	7325	7930	8530	9530	11020	12445	13910	15500	16995	18485	19055			
30 mph	6645	7190	7740	8640	9995	11285	12615	14060	15415	16765	17280			
40 mph	5675	6105	6535	7385	8545	9535	10650	12015	13175	14330	14770			

Rim Size (inch)		Description										MSPN (CAI)		
26.5		VF 650/65 R26.5 179D IMP TL [NEW 2nd Half 2022]										86356 (059338)		
Section Width	Overall Diam. (in.)	Loaded Radius (in.)	Rolling Circum. (in.)	Recommended Rim	Acceptable Rims						Min. Dual / Triple Spacing (in.)	75% internal volume (gal.)	Tread depth (32nd in.)	
26.4	60.0	26.2	177.0	AG20.00(H2)							32.5	124.8	30	
Psi	12	13	15	17	22	26	30	35	39	44	46			
6 mph	11630	12400	13175	14715	17030	18925	20810	22710	24790	26885	28275			
15 mph	10360	11045	11730	13105	15155	16845	18540	20225	22090	23955	25190			
25 mph	9150	9755	10360	11575	13395	14880	16370	17855	19510	21165	22265			
30 mph	8265	8830	9380	10505	12180	13525	14860	16205	17690	19180	20170			
40 mph	7165	7640	8115	9050	10470	11605	12755	13890	15090	16290	17085			

Rim Size (inch)		Description										MSPN (CAI)		
30.5		VF 600/60 R30.5 175D IMP TL [NEW 2nd Half 2022]										30202 (286219)		
Section Width	Overall Diam. (in.)	Loaded Radius (in.)	Rolling Circum. (in.)	Recommended Rim	Acceptable Rims						Min. Dual / Triple Spacing (in.)	75% internal volume (gal.)	Tread depth (32nd in.)	
24.3	58.7	24.5	171.7	AG20.00(H2)							30.4	101.6	28	
Psi	12	13	15	17	22	26	30	35	39	44	46			
6 mph	9865	10595	11310	12765	14935	16710	18475	20250	22015	23790	24965			
15 mph	8765	9415	10055	11345	13285	14860	16435	18010	19590	21165	22210			
25 mph	7770	8335	8905	10040	11740	13130	14515	15915	17305	18695	19620			
30 mph	7055	7560	8080	9105	10635	11905	13160	14430	15695	16965	17800			
40 mph	6010	6450	6890	7770	9095	10175	11255	12335	13415	14495	15210			

* Refer to the notes at the end of the tables of this range

TRAILXBIB®

Tire specifications and pressure table. Load per tire in lbs.*

Rim Size (inch)		Description									MSPN (CAI)		
26.5		VF 710/50 R26.5 176D IMP TL									39765 (723409)		
Section Width	Overall Diam. (in.)	Loaded Radius (in.)	Rolling Circum. (in.)	Recommended Rim	Acceptable Rims					Min. Dual / Triple Spacing (in.)	75% internal volume (gal.)	Tread depth (32nd in.)	
29.1	54.3	22.4	158.3	AG24.00 (H2)						35.8	107.6	28	
Psi	12	13	15	17	22	26	30	35	39	44	46		
6 mph	10140	10890	11640	13130	15375	17195	19015	20835	22655	24470	25685		
15 mph	9040	9700	10360	11685	13670	15290	16920	18540	20160	21795	22875		
25 mph	7935	8530	9115	10295	12070	13505	14925	16360	17790	19225	20170		
30 mph	7220	7760	8290	9360	10970	12260	13560	14850	16140	17440	18300		
40 mph	6175	6625	7090	8005	9370	10485	11585	12700	13800	14915	15655		

Rim Size (inch)		Description									MSPN (CAI)		
30.5		VF 650/65 R30.5 181D IMP TL									02919 (120737)		
Section Width	Overall Diam. (in.)	Loaded Radius (in.)	Rolling Circum. (in.)	Recommended Rim	Acceptable Rims					Min. Dual / Triple Spacing (in.)	75% internal volume (gal.)	Tread depth (32nd in.)	
25.6	64.3	27.8	189.2	AG20.00 (H2)						32.5	136.7	34	
Psi	12	13	15	17	22	26	30	35	39	44	46		
6 mph	12455	13295	14145	15820	17780	19730	21990	24250	26335	28430	29820		
15 mph	11080	11840	12600	14110	15820	17525	19545	21550	23435	25310	26565		
25 mph	9810	10470	11135	12455	13975	15485	17285	19070	20725	22375	23480		
30 mph	8875	9480	10085	11300	12675	14055	15685	17305	18795	20285	21275		
40 mph	7605	8115	8630	9645	10835	12015	13395	14770	16050	17340	18190		

Rim Size (inch)		Description									MSPN (CAI)		
30.5		VF 710/50 R30.5 178D IMP TL [NEW 2nd Half 2022]									22998 (562163)		
Section Width	Overall Diam. (in.)	Loaded Radius (in.)	Rolling Circum. (in.)	Recommended Rim	Acceptable Rims					Min. Dual / Triple Spacing (in.)	75% internal volume (gal.)	Tread depth (32nd in.)	
28.6	58.6	25.7	173.1	AG24.00(H2)						35.8	118.1	32	
Psi	12	13	15	17	22	26	30	35	39	44	46		
6 mph	10860	11630	12400	13945	16260	18135	20005	21880	23885	25895	27225		
15 mph	9645	10340	11035	12410	14495	16150	17800	19455	21255	23050	24250		
25 mph	8545	9150	9755	10970	12785	14255	15730	17195	18785	20380	21440		
30 mph	7770	8320	8875	9975	11630	12950	14275	15600	17040	18495	19455		
40 mph	6615	7090	7560	8500	9920	11025	12125	13230	14475	15710	16535		

Rim Size (inch)		Description									MSPN (CAI)		
30.5		VF 750/60 R30.5 187D IMP TL									20302 (223428)		
Section Width	Overall Diam. (in.)	Loaded Radius (in.)	Rolling Circum. (in.)	Recommended Rim	Acceptable Rims					Min. Dual / Triple Spacing (in.)	75% internal volume (gal.)	Tread depth (32nd in.)	
30.8	66.1	27.4	191.9	AG24.00 (H2)						37.6	171.5	34	
Psi	12	13	15	17	22	26	30	35	39	44	46		
6 mph	14000	15025	16040	18080	20425	22765	25385	28000	30730	33455	35275		
15 mph	12455	13370	14275	16095	18190	20285	22630	24965	27370	29760	31360		
25 mph	11025	11830	12620	14220	16070	17915	19985	22045	24175	26300	27725		
30 mph	9975	10705	11440	12895	14585	16260	18135	20005	21925	23855	25135		
40 mph	8545	9160	9790	11025	12455	13890	15485	17085	18740	20395	21495		

* Refer to the notes at the end of the tables of this range



TRAILXBIB®

Tire specifications and pressure table. Load per tire in lbs.*

Rim Size (inch)		Description										MSPN (CAI)		
30.5		VF 850/50 R30.5 188D IMP TL [NEW 2nd Half 2022]										79539 (659949)		
Section Width	Overall Diam. (in.)	Loaded Radius (in.)	Rolling Circum. (in.)	Recommended Rim	Acceptable Rims						Min. Dual / Triple Spacing (in.)	75% internal volume (gal.)	Tread depth (32nd in.)	
33.7	64.0	26.9	187.3	AG28.00(H2)								42.2	179.9	32
Psi	12	13	15	17	22	26	30	35	39	44	46			
6 mph	14385	15410	16435	18475	21550	24010	26480	28935	31605	34270	36045			
15 mph	12785	13700	14615	16435	19180	21365	23555	25740	28120	30490	32075			
25 mph	11300	12115	12920	14540	16975	18905	20835	22765	24845	26940	28330			
30 mph	10250	10980	11720	13185	15375	17120	18870	20615	22530	24460	25740			
40 mph	8820	9445	10075	11345	13230	14695	16170	17635	19290	20945	22045			

***IMPORTANT:**

The inflation pressure must always be appropriate for the load per tire, the speed of travel and the work to be done. Our recommendations above are provided subject to changes made after the date of publication of these tables. Technical data is subject to change without prior notice.

- When using single tire configuration:
 - add 6 psi for use on slopes of more than 20%
 - add 6 psi for intense road use exceeding 50%



CARGOXBIB® HIGH FLOTATION

THE LOW-PRESSURE TRAILER TIRE WITH
LESS IMPACT ON THE SOIL

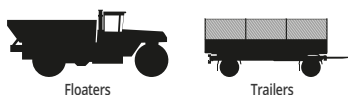

PRODUCTIVITY

- Unique tread design delivers enhanced self cleaning ability
- First low pressure tire compatible with central tire inflation systems
- With a large contact patch, this tire offers max flotation and soil protection



LOAD CAPACITY

- Steel belted radial design delivers high load capacities at high speeds



VF Tires Only



ROBUST DESIGN

- Steel belted casing design for enhanced durability under high loads
- Excellent puncture resistance and optimized load distribution
- Solid rounded shoulders for greater resistance to irregular wear, reduced scrub and improved maneuverability



SIZES

710/45 R22.5 165D TL

28 LR26 175D TL

600/55 R26.5 165D TL

650/55 R26.5 169D TL

710/50 R26.5 170D TL

VF600/55 R26.5 170D IMP TL

VF650/55 R26.5 174D IMP TL

VF710/50 R26.5 176D IMP TL

650/65 R30.5 176D TL

750/60 R30.5 181D TL

VF750/60 R30.5 187D IMP TL

800/60 R32 185D IMP TL

CARGOXBIB® HIGH FLOTATION

Tire specifications and pressure table. Load per tire in lbs.*

Rim Size (inch)	Description											MSPN (CAI)			
22.5	710/45 R22.5 165D TL [DISCONTINUED]											06153 (723051)			
Section Width	Overall Diam. (in.)	Loaded Radius (in.)	Rolling Circum. (in.)	Recommended Rim	Acceptable Rims						Min. Dual / Triple Spacing (in.)	75% internal volume (gal.)	Tread depth (32nd in.)		
28.5	47.6	20.2	139.6	AG24.00 (H2)	AG20.00 (H2)						35.8	83.8	20		
Psi	12	13	15	17	22	26	30	35	39	44	46	49	52	55	58
6 mph	6550	7560	8575	9535	10955	12390	13825	15255	16225	17195	17845	18495	19145	19785	20435
15 mph	5755	6460	7165	8045	9380	10705	12035	13360	14220	15080	15655	16225	16800	17370	17945
25 mph	4960	5565	6175	6935	8080	9225	10360	11510	12245	12985	13470	13965	14450	14945	15430
30 mph	4410	4950	5490	6160	7185	8200	9215	10230	10890	11540	11980	12425	12865	13295	13735
40 mph	3640	4090	4540	5105	5940	6780	7630	8465	9005	9545	9910	10275	10635	10990	11355

Rim Size (inch)	Description											MSPN (CAI)			
26	28 LR 26 175D TL											00986 (224829)			
Section Width	Overall Diam. (in.)	Loaded Radius (in.)	Rolling Circum. (in.)	Recommended Rim	Acceptable Rims						Min. Dual / Triple Spacing (in.)	75% internal volume (gal.)	Tread depth (32nd in.)		
29.1	62.2	27.8	184.4	DW25B (A)	DW23B(A)						35.7	152.5	33		
Psi	12	13	15	17	22	26	30	35	39	44	46	49	52	55	58
10 mph	8265	8675	9085	10175	11815	13020	14240	15510	16765	17430	17945	18465	19200	19800	20380
15 mph	7320	7685	8035	9005	10450	11510	12590	13715	14825	15410	15875	16325	16985	17505	18025
25 mph	6755	7090	7420	8310	9655	10635	11640	12675	13700	14240	14670	15090	15695	16180	16655
30 mph	6480	6800	7120	7980	9260	10195	11155	12160	13140	13660	14065	14475	15045	15510	15970
40 mph	6175	6480	6780	7595	8820	9710	10625	11575	12510	13005	13395	13780	14330	14770	15210

Rim Size (inch)	Description											MSPN (CAI)			
26.5	600/55 R26.5 165D TL [DISCONTINUED]											32505 (550621)			
Section Width	Overall Diam. (in.)	Loaded Radius (in.)	Rolling Circum. (in.)	Recommended Rim	Acceptable Rims						Min. Dual / Triple Spacing (in.)	75% internal volume (gal.)	Tread depth (32nd in.)		
25	53	22.9	155.7	AG20.00 (H2)							24.7	82.4	21		
Psi	12	13	15	17	22	26	30	35	39	44	46	49	52	55	58
10 mph	6550	7905	9260	10305	11860	13425	14990	16555	17285	18010	18495	18980	19465	19950	20435
15 mph	5755	6800	7850	8805	10230	11660	13095	14530	15170	15805	16235	16665	17095	17515	17945
25 mph	4960	5895	6835	7640	8865	10075	11290	12500	13050	13605	13965	14330	14705	15070	15430
30 mph	4410	5235	6065	6790	7870	8960	10040	11135	11620	12115	12435	12765	13085	13415	13735
40 mph	3640	4355	5070	5655	6550	7430	8310	9195	9600	10010	10275	10550	10815	11090	11355

Rim Size (inch)	Description											MSPN (CAI)			
26.5	650/55 R26.5 169D TL [DISCONTINUED]											15666 (693431)			
Section Width	Overall Diam. (in.)	Loaded Radius (in.)	Rolling Circum. (in.)	Recommended Rim	Acceptable Rims						Min. Dual / Triple Spacing (in.)	75% internal volume (gal.)	Tread depth (32nd in.)		
26	55	24.3	163.7	AG20.00 (H2)							35.5	115.5	23		
Psi	12	13	15	17	22	26	30	35	39	44	46	49	52	55	58
10 mph	7340	8785	10220	11510	13450	15155	16755	18355	19355	20360	21030	21530	22025	22520	23015
15 mph	6450	7715	8975	10110	11805	13305	14715	16115	17000	17880	18465	18905	19335	19775	20205
25 mph	5545	6635	7715	8695	10165	11455	12665	13865	14630	15390	15895	16270	16645	17020	17395
30 mph	4940	5910	6865	7740	9040	10185	11265	12335	13020	13690	14145	14475	14815	15145	15475
40 mph	4080	4885	5675	6395	7475	8420	9305	10195	10760	11310	11685	11960	12235	12510	12785

* Refer to the notes at the end of the tables of this range

CARGOXBIB® HIGH FLOTATION

Tire specifications and pressure table. Load per tire in lbs.*

Rim Size (inch)		Description										MSPN (CAI)			
26.5		710/50 R26.5 170D TL [DISCONTINUED]										29880 (892516)			
Section Width	Overall Diam. (in.)	Loaded Radius (in.)	Rolling Circum. (in.)	Recommended Rim	Acceptable Rims						Min. Dual / Triple Spacing (in.)	75% internal volume (gal.)	Tread depth (32nd in.)		
29	54	23.4	159.9	AG24.00 (H2)	AG20.00 (H2)						26.9	107.6	23		
Psi	12	13	15	17	22	26	30	35	39	44	46	49	52	55	58
10 mph	7740	9270	10805	12015	13835	15655	17470	19290	20140	20990	21550	22110	22685	23250	23810
15 mph	6790	7960	9125	10240	11905	13570	15245	16910	17660	18410	18905	19400	19910	20405	20900
25 mph	5840	6900	7960	8905	10320	11740	13150	14575	15210	15850	16280	16710	17140	17560	17990
30 mph	5205	6130	7055	7905	9160	10430	11695	12965	13535	14110	14485	14870	15245	15630	16005
40 mph	4300	5105	5910	6590	7630	8655	9690	10715	11190	11660	11970	12290	12600	12920	13230

Rim Size (inch)		Description										MSPN (CAI)			
26.5		VF 600/55 R26.5 170D IMP TL [DISCONTINUED]										28332 (377726)			
Section Width	Overall Diam. (in.)	Loaded Radius (in.)	Rolling Circum. (in.)	Recommended Rim	Acceptable Rims						Min. Dual / Triple Spacing (in.)	75% internal volume (gal.)	Tread depth (32nd in.)		
24.6	52.8	22.1	154.4	AG20.00 (H2)							29.9	82.4	21		
Psi	12	13	15	17	22	26	30	35	39	44	46	49	52	55	58
6 mph	8315	8875	9400	10485	12475	13940	15610	17175	18845	20245	21695				
15 mph	7405	7900	8370	9335	11105	12410	13900	15290	16775	18025	19310				
25 mph	6540	6980	7395	8245	9815	10965	12280	13510	14825	15925	17065				
30 mph	5935	6330	6705	7480	8900	9945	11135	12255	13445	14445	15475				
40 mph	5070	5400	5730	6395	7605	8500	9435	10470	11630	12345	13230				

Rim Size (inch)		Description										MSPN (CAI)			
26.5		VF 650/55 R26.5 174D IMP TL [DISCONTINUED]										33527 (776393)			
Section Width	Overall Diam. (in.)	Loaded Radius (in.)	Rolling Circum. (in.)	Recommended Rim	Acceptable Rims						Min. Dual / Triple Spacing (in.)	75% internal volume (gal.)	Tread depth (32nd in.)		
25.9	55.2	23.9	162.6	AG20.00							32.5	115.5	23		
Psi	12	13	15	17	22	26	30	35	39	44	46	49	52	55	58
6 mph	9310	10080	10845	12110	14010	15820	17685	19705	21605	23500	24225				
15 mph	8290	8975	9655	10785	12475	14085	15740	17540	19235	20920	21565				
25 mph	7325	7930	8530	9530	11020	12445	13910	15500	16995	18485	19055				
30 mph	6645	7190	7740	8640	9995	11285	12615	14060	15415	16765	17280				
40 mph	5675	6105	6535	7385	8545	9535	10650	12015	13175	14330	14770				

Rim Size (inch)		Description										MSPN (CAI)			
26.5		710/50 R26.5 176D IMP TL [DISCONTINUED]										20991 (343405)			
Section Width	Overall Diam. (in.)	Loaded Radius (in.)	Rolling Circum. (in.)	Recommended Rim	Acceptable Rims						Min. Dual / Triple Spacing (in.)	75% internal volume (gal.)	Tread depth (32nd in.)		
28.7	54.3	22.4	158.3	AG24.00 (H2)							35.8	107.6	23		
Psi	12	13	15	17	22	26	30	35	39	44	46	49	52	55	58
6 mph	9850	10510	11355	12835	14915	16540	18520	20245	22225	24225	25670				
15 mph	8770	9360	10105	11425	13280	14725	16485	18025	19785	21565	22855				
25 mph	7750	8265	8930	10095	11730	13010	14565	15925	17480	19055	20190				
30 mph	7030	7500	8100	9160	10640	11800	13210	14445	15855	17280	18315				
40 mph	6010	6460	6925	7825	9095	10085	11145	12345	13835	14770	15655				

* Refer to the notes at the end of the tables of this range

CARGOXBIB® HIGH FLOTATION

Tire specifications and pressure table. Load per tire in lbs.*

Rim Size (inch)		Description										MSPN (CAI)			
30.5		650/65 R30.5 176D TL [DISCONTINUED]										28171 (139310)			
Section Width	Overall Diam. (in.)	Loaded Radius (in.)	Rolling Circum. (in.)	Recommended Rim	Acceptable Rims					Min. Dual / Triple Spacing (in.)	75% internal volume (gal.)	Tread depth (32nd in.)			
26.5	63.9	27.5	188	AG20.00 (H2)						32.5	158.5	26			
Psi	12	13	15	17	22	26	30	35	39	44	46	49	52	55	58
6 mph	9125	10955	12785	14220	16380	18530	20690	22840	23845	24845	25505	26180	26840	27515	28175
15 mph	8025	9415	10805	12115	14100	16070	18045	20020	20900	21795	22375	22970	23555	24150	24735
25 mph	6900	8170	9435	10550	12225	13900	15565	17240	18000	18760	19270	19775	20285	20790	21295
30 mph	6130	7240	8355	9360	10845	12345	13845	15345	16015	16690	17140	17595	18045	18485	18940
40 mph	5070	6030	6990	7805	9015	10240	11455	12675	13240	13790	14165	14540	14915	15280	15655

Rim Size (inch)		Description										MSPN (CAI)			
30.5		750/60 R30.5 181D TL [DISCONTINUED]										77049 (101332)			
Section Width	Overall Diam. (in.)	Loaded Radius (in.)	Rolling Circum. (in.)	Recommended Rim	Acceptable Rims					Min. Dual / Triple Spacing (in.)	75% internal volume (gal.)	Tread depth (32nd in.)			
31	66	28.2	194.3	AG24.00 (H2)						32.7	198.1	28			
Psi	12	13	15	17	22	26	30	35	39	44	46	49	52	55	58
10 mph	10515	12675	14835	16515	19015	21530	24030	26545	27700	28870	29640	30415	31195	31965	32740
15 mph	9225	10900	12565	14100	16380	18675	20965	23260	24285	25320	26005	26685	27380	28065	28750
25 mph	7950	9460	10955	12260	14200	16150	18090	20040	20920	21805	22390	22970	23565	24150	24735
30 mph	7065	8400	9720	10880	12610	14340	16085	17815	18595	19390	19910	20435	20955	21485	22000
40 mph	5840	6980	8115	9060	10470	11895	13305	14725	15375	16030	16460	16885	17330	17760	18190

Rim Size (inch)		Description										MSPN (CAI)			
30.5		VF 750/60 R30.5 187D IMP TL [DISCONTINUED]										08620 (139588)			
Section Width	Overall Diam. (in.)	Loaded Radius (in.)	Rolling Circum. (in.)	Recommended Rim	Acceptable Rims					Min. Dual / Triple Spacing (in.)	75% internal volume (gal.)	Tread depth (32nd in.)			
30.7	65.9	27	191.9	AG24.00 (H2)						37.6	198.1	26			
Psi	12	13	15	17	22	26	30	35	39	44	46	49	52	55	58
6 mph	13560	14460	15365	17175	19885	22595	25310	28020	30730	33445	35250				
15 mph	12070	12875	13680	15290	17705	20115	22530	24945	27360	29775	31385				
25 mph	10665	11375	12090	13515	15640	17780	19910	22040	24175	26310	27730				
30 mph	9675	10320	10965	12260	14185	16125	18055	19990	21925	23865	25150				
40 mph	8265	8820	9370	10470	12125	13780	15430	17085	18740	20395	21495				

Rim Size (inch)		Description										MSPN (CAI)			
32		800/60 R32 185D IMP TL										50441 (322432)			
Section Width	Overall Diam. (in.)	Loaded Radius (in.)	Rolling Circum. (in.)	Recommended Rim	Acceptable Rims					Min. Dual / Triple Spacing (in.)	75% internal volume (gal.)	Tread depth (32nd in.)			
32.2	70.9	30.6	208.7	DW27B (A)	DW25B (A)					0.0	237.7	30			
Psi	12	13	15	17	22	26	30	35	39	44	46	49	52	55	58
6 mph	11905	14385	16865	18915	21990	24705	27240	29760	31625	33490	34725	35220	35715	36210	36705
15 mph	10450	12630	14805	16600	19300	21680	23910	26125	27755	29390	30480	30920	31350	31790	32220
25 mph	8995	10870	12745	14295	16625	18675	20580	22485	23900	25300	26235	26610	26985	27360	27735
30 mph	8005	9680	11345	12720	14795	16610	18310	20005	21265	22510	23345	23680	24020	24350	24680
40 mph	6615	7990	9370	10505	12215	13725	15135	16535	17570	18605	19290	19565	19840	20115	20395

*IMPORTANT:

The inflation pressure must always be appropriate for the load per tire, the speed of travel and the work to be done. Our recommendations above are provided subject to changes made after the date of publication of these tables. Technical data is subject to change without prior notice.

- When using single tire configuration:
 - add 6 psi for use on slopes of more than 20%
 - add 6 psi for intense road use exceeding 50%



CARGOXBIB® HEAVY DUTY

EXCELLENT SOLUTION FOR
TRANSPORTING HARVESTS



Floater



Trailers



SERVICE LIFE

- Proven casing endurance
- Solid rounded shoulders increases maneuverability and reduces scrub
- Flat crown for long, even wear



VERSATILITY

- Even distribution of ground pressure to minimize rutting and soil damage
- Very good self-cleaning
- Good handling on and off-road
- Excellent grip in difficult conditions



STEEL CROWN BELTS

- Great stability
- Excellent puncture resistance and optimized load distribution



SIZES

500/60 R22.5 155D TL

560/45 R22.5 152D TL

560/60 R22.5 161D TL

CARGOXBIB® HEAVY DUTY

Tire specifications and pressure table. Load per tire in lbs.*

Rim Size (inch)		Description										MSPN (CAI)			
22.5		500/60 R22.5 155D TL [DISCONTINUED]										36343 (441880)			
Section Width	Overall Diam. (in.)	Loaded Radius (in.)	Rolling Circum. (in.)	Recommended Rim	Acceptable Rims					Min. Dual / Triple Spacing (in.)	75% internal volume (gal.)	Tread depth (32nd in.)			
19.9	46.1	20	136	AG16.00 (H2)	14.00 15.00 16.00 17.00					25.7	54.3	20			
Psi	12	13	15	17	22	26	30	35	39	44	46	49	52	55	58
6 mph	4960	5965	6965	7750	8930	10110	11275	12455	13005	13560	13920	14285	14660	15025	15390
15 mph	4355	5135	5910	6625	7705	8785	9855	10935	11420	11895	12215	12535	12855	13175	13490
25 mph	3750	4440	5135	5745	6670	7585	8500	9415	9835	10240	10515	10790	11065	11345	11620
30 mph	3330	3945	4565	5105	5930	6745	7560	8380	8740	9115	9360	9600	9855	10095	10340
40 mph	2755	3285	3815	4255	4925	5590	6260	6925	7230	7540	7740	7950	8145	8355	8555

Rim Size (inch)		Description										MSPN (CAI)			
22.5		560/45 R22.5 152D TL										27334 (743789)			
Section Width	Overall Diam. (in.)	Loaded Radius (in.)	Rolling Circum. (in.)	Recommended Rim	Acceptable Rims					Min. Dual / Triple Spacing (in.)	75% internal volume (gal.)	Tread depth (32nd in.)			
21.1	42.5	18.7	125.6	AG16.00 (H2)						27.6	48.1	20			
Psi	12	13	15	17	22	26	30	35	39	44	46	49	52	55	58
6 mph	4565	4905	5235	5875	6825	7660	8475	9360	10250	11135	11730	12315	12910	13490	14090
15 mph	4010	4310	4595	5160	5995	6725	7440	8210	8995	9780	10295	10815	11330	11850	12370
25 mph	3450	3705	3955	4440	5160	5785	6395	7065	7740	8410	8865	9305	9755	10195	10650
30 mph	3065	3295	3525	3955	4595	5160	5700	6295	6890	7495	7895	8290	8685	9085	9480
40 mph	2535	2725	2910	3265	3790	4255	4705	5205	5690	6185	6515	6845	7165	7495	7825

Rim Size (inch)		Description										MSPN (CAI)			
22.5		560/60 R22.5 161D TL [DISCONTINUED]										20379 (102433)			
Section Width	Overall Diam. (in.)	Loaded Radius (in.)	Rolling Circum. (in.)	Recommended Rim	Acceptable Rims					Min. Dual / Triple Spacing (in.)	75% internal volume (gal.)	Tread depth (32nd in.)			
21.4	48.9	20.9	143.7	AG16.00 (H2)	16.00 17.00 AG20.00 (H2)					28.7	70.9	20			
Psi	12	13	15	17	22	26	30	35	39	44	46	49	52	55	58
6 mph	5950	7145	8335	9270	10670	12070	13480	14880	15530	16195	16625	17065	17495	17935	18365
15 mph	5225	6130	7035	7895	9170	10460	11740	13030	13615	14185	14575	14960	15345	15730	16115
25 mph	4495	5325	6150	6880	7960	9050	10130	11220	11720	12215	12545	12875	13205	13535	13865
30 mph	3990	4720	5445	6095	7065	8035	9015	9985	10430	10870	11165	11465	11760	12050	12345
40 mph	3305	3935	4565	5095	5885	6680	7475	8265	8630	8995	9235	9480	9720	9965	10205

*IMPORTANT:

The inflation pressure must always be appropriate for the load per tire, the speed of travel and the work to be done. Our recommendations above are provided subject to changes made after the date of publication of these tables. Technical data is subject to change without prior notice.

- When using single tire configuration:
 - add 6 psi for use on slopes of more than 20%
 - add 6 psi for intense road use exceeding 50%



CARGOXBIB®

ENHANCED ENDURANCE FOR
HEAVY LOADS AT LOW PRESSURES



SOIL PROTECTION

- -41% shallower ruts¹



PROFITABILITY

- -27% less resistance helps save fuel²



PRODUCTIVITY

- Saves time²
- Impressive load carrying capacity at high speeds, up to to 40 mph



STEEL CROWN BELTS

- Great stability
- Excellent puncture resistance and optimized load distribution



(1) MICHELIN Test and Research Center (Ladoux) Size: 600/55 R26.5 (600/55 - 26.5 for competitor C) Conditions: 9.6 lbs at 20 mph
(2) MICHELIN Test and Research Center (Ladoux) Size: 600/55 R26.5 (600/55 - 26.5 for competitor C) Conditions: 14,330 lbs at 5 mph

SIZES

600/50 R22.5 159D TL

800/45 R26.5 174D TL

600/60 R30.5 169D TL

710/50 R30.5 173D TL

800/45 R30.5 176D TL

850/50 R30.5 182D TL

600/50 R22.5 159D TL

Tire specifications and pressure table. Load per tire in lbs.*

Rim Size (inch)		Description										MSPN (CAI)		
22.5		600/50 R22.5 159D TL [DISCONTINUED]										94336 (048429)		
Section Width	Overall Diam. (in.)	Loaded Radius (in.)	Rolling Circum. (in.)	Recommended Rim	Acceptable Rims						Min. Dual / Triple Spacing (in.)	75% internal volume (gal.)	Tread depth (32nd in.)	
24.3	46.5	20.1	136.9	AG20.00 (H2)							29.9	78.6	21	
Psi	15	19	22	28	32	36	41	45	49	54	58			
6 mph	7870	9195	10085	11850	13185	14275	14890	15510	16140	16755	17370			
15 mph	6660	7870	8685	10295	11520	12510	13050	13605	14145	14695	15235			
25 mph	5820	6845	7540	8905	9945	10780	11255	11720	12180	12655	13120			
30 mph	5160	6085	6690	7925	8840	9600	10010	10430	10835	11255	11660			
40 mph	4300	5050	5555	6550	7310	7925	8265	8620	8960	9315	9655			

Rim Size (inch)		Description										MSPN (CAI)		
26.5		800/45 R26.5 174D TL										81371 (248959)		
Section Width	Overall Diam. (in.)	Loaded Radius (in.)	Rolling Circum. (in.)	Recommended Rim	Acceptable Rims						Min. Dual / Triple Spacing (in.)	75% internal volume (gal.)	Tread depth (32nd in.)	
32.1	54.9	23.4	161.3	AG28.00 (H2)	AG24.00 (H2)						39.7	148.2	24	
Psi	15	19	22	28	32	36	41	45	49	54	58			
6 mph	11175	13030	14275	16745	18605	20260	21530	22795	24065	25320	26590			
15 mph	9325	11055	12205	14515	16235	17770	18885	19995	21120	22235	23345			
25 mph	8025	9515	10505	12490	13975	15290	16250	17205	18165	19125	20085			
30 mph	7145	8465	9350	11110	12435	13605	14460	15310	16170	17020	17880			
40 mph	5910	7000	7725	9180	10275	11235	11950	12655	13360	14065	14770			

Rim Size (inch)		Description										MSPN (CAI)		
30.5		600/60 R30.5 169D TL [DISCONTINUED]										51915 (236518)		
Section Width	Overall Diam. (in.)	Loaded Radius (in.)	Rolling Circum. (in.)	Recommended Rim	Acceptable Rims						Min. Dual / Triple Spacing (in.)	75% internal volume (gal.)	Tread depth (32nd in.)	
25.2	58.9	25.7	173.9	AG20.00 (H2)							30.2	123.8	26	
Psi	15	19	22	28	32	36	41	45	49	54	58			
6 mph	10430	12190	13360	15720	17470	18925	19740	20560	21385	22200	23015			
15 mph	8820	10440	11510	13670	15280	16600	17315	18035	18760	19480	20195			
25 mph	7695	9060	9975	11805	13175	14295	14915	15530	16160	16775	17395			
30 mph	6835	8060	8865	10495	11705	12710	13260	13810	14375	14925	15475			
40 mph	5710	6700	7375	8695	9700	10515	10970	11420	11885	12335	12785			

Rim Size (inch)		Description										MSPN (CAI)		
30.5		710/50 R30.5 173D TL [DISCONTINUED]										92209 (002786)		
Section Width	Overall Diam. (in.)	Loaded Radius (in.)	Rolling Circum. (in.)	Recommended Rim	Acceptable Rims						Min. Dual / Triple Spacing (in.)	75% internal volume (gal.)	Tread depth (32nd in.)	
28.7	58.9	25.6	173.5	AG24.00 (H2)							35.8	141.8	26	
Psi	15	19	22	28	32	36	41	45	49	54	58			
6 mph	11705	13680	14990	17615	19590	21210	22125	23040	23965	24880	25795			
15 mph	9900	11705	12910	15310	17120	18595	19400	20215	21020	21835	22640			
25 mph	8620	10150	11175	13230	14760	16015	16710	17405	18100	18795	19490			
30 mph	7650	9015	9930	11760	13130	14255	14870	15485	16115	16735	17350			
40 mph	6395	7520	8255	9755	10870	11785	12300	12810	13315	13825	14330			

* Refer to the notes at the end of the tables of this range

CARGOXBIB®

Tire specifications and pressure table. Load per tire in lbs.*

Rim Size (inch)		Description									MSPN (CAI)		
30.5		800/45 R30.5 176D TL									53255 (932951)		
Section Width	Overall Diam. (in.)	Loaded Radius (in.)	Rolling Circum. (in.)	Recommended Rim	Acceptable Rims					Min. Dual / Triple Spacing (in.)	75% internal volume (gal.)	Tread depth (32nd in.)	
32.3	58.9	25.6	173.5	AG28.00 (H2)							39.7	162.6	26
Psi	15	19	22	28	32	36	41	45	49	54	58		
6 mph	11840	13810	15125	17745	19720	21485	22820	24165	25495	26840	28175		
15 mph	9900	11730	12940	15390	17205	18825	20005	21185	22375	23555	24735		
25 mph	8510	10085	11145	13240	14825	16215	17230	18245	19270	20285	21295		
30 mph	7585	8985	9910	11785	13175	14405	15320	16225	17130	18035	18940		
40 mph	6260	7420	8190	9735	10890	11915	12665	13405	14155	14905	15655		

Rim Size (inch)		Description									MSPN (CAI)		
30.5		850/50 R30.5 182D TL [DISCONTINUED]									69986 (938016)		
Section Width	Overall Diam. (in.)	Loaded Radius (in.)	Rolling Circum. (in.)	Recommended Rim	Acceptable Rims					Min. Dual / Triple Spacing (in.)	75% internal volume (gal.)	Tread depth (32nd in.)	
33.9	64.1	27.2	188.1	AG28.00 (H2)							42.2	215.7	29
Psi	15	19	22	28	32	36	41	45	49	54	58		
6 mph	14175	16535	18100	21255	23600	25715	27315	28925	30525	32130	33730		
15 mph	11840	14030	15485	18420	20600	22540	23955	25365	26785	28195	29610		
25 mph	10185	12070	13340	15850	17745	19410	20625	21835	23060	24275	25485		
30 mph	9060	10750	11860	14110	15785	17275	18355	19435	20525	21605	22685		
40 mph	7495	8885	9810	11660	13050	14275	15170	16060	16955	17845	18740		

CARGOXBIB® 2

Rim Size (inch)		Description									MSPN (CAI)		
22.5		600/50 R22.5 159D TL [DISCONTINUED]									88721 (740591)		
Section Width	Overall Diam. (in.)	Loaded Radius (in.)	Rolling Circum. (in.)	Recommended Rim	Acceptable Rims					Min. Dual / Triple Spacing (in.)	75% internal volume (gal.)	Tread depth (32nd in.)	
24.3	46.5	20.1	136.9	AG20.00 (H2)							29.9	78.6	21
Psi	15	19	22	28	32	36	41	45	49	54	58		
6 mph	7870	9195	10085	11850	13185	14275	14890	15510	16140	16755	17375		
15 mph	6660	7870	8685	10295	11520	12510	13050	13605	14145	14695	15235		
25 mph	5820	6845	7540	8905	9945	10780	11255	11720	12180	12655	13120		
30 mph	5160	6085	6690	7925	8840	9600	10010	10430	10835	11255	11665		
40 mph	4300	5050	5555	6550	7310	7925	8265	8620	8960	9315	9655		

***IMPORTANT:**

The inflation pressure must always be appropriate for the load per tire, the speed of travel and the work to be done. Our recommendations above are provided subject to changes made after the date of publication of these tables. Technical data is subject to change without prior notice.

- When using single tire configuration:
 - add 6 psi for use on slopes of more than 20%
 - add 6 psi for intense road use exceeding 50%



XP27™

**ENHANCED DURABILITY AND
HIGH LOAD CAPACITY**

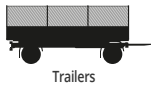

Trailers



Tillage Machine



SERVICE LIFE

- Flat tread profile and a robust casing provide durability for a longer tire life



HIGH LOAD CAPACITY



SIZES

270/65R16 134A8/122A8 TL

270/65R18 136A8/124A8 TL

340/65R18 149A8/137A8 TL

Tire specifications and pressure table. Load per tire in lbs.*

Rim Size (inch)		Description										MSPN (CAI)			
16		270/65 R16 134A8/122A8 TL										04629 (184332)			
Section Width	Overall Diam. (in.)	Loaded Radius (in.)	Rolling Circum. (in.)	Recommended Rim	Acceptable Rims					Min. Dual / Triple Spacing (in.)	75% internal volume (gal.)	Tread depth (32nd in.)			
10.4	29.7	13.1	90.6	W8	W7 W9					15.0	11.9	11			
Psi	15	19	22	28	32	36	41	45	49	54	58	59	64	68	73
6 mph	2335	2725	2975	3485	3870	4255	4640	5025	5400	5785	6175	6205	6325	6435	6550
15 mph	1975	2305	2525	2955	3285	3615	3935	4265	4595	4915	5245	5280	5380	5465	5565
20 mph	1850	2160	2360	2765	3075	3385	3695	4000	4300	4610	4915	4950	5040	5135	5225
25 mph	1655	1930	2115	2480	2755	3030	3305	3585	3860	4135	4410	4430	4520	4595	4675
30 mph	1520	1775	1940	2280	2535	2790	3040	3295	3550	3805	4055	4080	4155	4220	4300

Rim Size (inch)		Description										MSPN (CAI)			
18		270/65 R18 136A8/124A8 TL										98595 (133069)			
Section Width	Overall Diam. (in.)	Loaded Radius (in.)	Rolling Circum. (in.)	Recommended Rim	Acceptable Rims					Min. Dual / Triple Spacing (in.)	75% internal volume (gal.)	Tread depth (32nd in.)			
10.4	31.9	14.2	97.3	W8	9 W9					15.0	13.5	11			
Psi	15	19	22	28	32	36	41	45	49	54	58	59	64	68	73
6 mph	2470	2875	3140	3680	4090	4495	4905	5315	5710	6120	6525	6570	6680	6800	6925
15 mph	2095	2435	2670	3130	3470	3815	4155	4495	4850	5190	5535	5565	5665	5775	5875
20 mph	1960	2280	2500	2930	3265	3585	3900	4235	4555	4885	5205	5235	5335	5435	5535
25 mph	1765	2050	2250	2635	2920	3210	3495	3780	4080	4365	4650	4685	4760	4850	4940
30 mph	1610	1875	2050	2415	2680	2945	3210	3470	3750	4010	4275	4300	4385	4465	4540

Rim Size (inch)		Description										MSPN (CAI)			
18		340/65 R18 149A8/137A8 TL										08185 (415969)			
Section Width	Overall Diam. (in.)	Loaded Radius (in.)	Rolling Circum. (in.)	Recommended Rim	Acceptable Rims					Min. Dual / Triple Spacing (in.)	75% internal volume (gal.)	Tread depth (32nd in.)			
13.5	35.1	15.5	107.1	11	9 W9					18.2	21.2	10			
Psi	15	19	22	28	32	36	41	45	49	54	58	59	64	68	73
6 mph	3570	4155	4555	5335	5920	6505	7090	7670	8265	8850	9435	9490	9680	9855	10030
15 mph	3040	3540	3870	4540	5040	5535	6030	6525	7035	7530	8025	8080	8225	8380	8530
20 mph	2845	3320	3625	4255	4730	5205	5675	6150	6615	7090	7560	7605	7750	7880	8025
25 mph	2555	2975	3250	3815	4235	4650	5070	5490	5910	6325	6745	6790	6910	7045	7165
30 mph	2555	2975	3250	3815	4235	4650	5070	5490	5910	6325	6745	6790	6910	7045	7165

***IMPORTANT:**

The inflation pressure must always be appropriate for the load per tire, the speed of travel and the work to be done. Our recommendations above are provided subject to changes made after the date of publication of these tables. Technical data is subject to change without prior notice.

XP27: the 1st load index refers to use on a free wheel (use on hauled equipment), the 2nd refers to use on a drive wheel. The load/pressure/speed tables correspond to use on a free wheel. For a drive wheel, a 30 % reduction applies.

- When using single tire configuration:
 - add 6 psi for use on slopes of more than 20%
 - add 6 psi for intense road use exceeding 50%





COMPACT EQUIPMENT TIRES



If you try MICHELIN® Compact Line pneumatic tires for 90 days and aren't completely satisfied, we'll refund the full purchase price. MICHELIN® X® TWEEL® airless radial tires are covered by a 30-day Satisfaction Guarantee. See your authorized Michelin dealer for details.

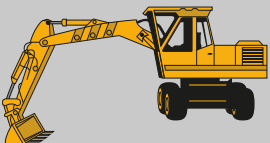

RANGES BY USE

MACHINES / TIRES	TECHNOLOGY												KEY SIZES*
	RADIAL										BIAS		
	XMCL	XM27	BIBLOAD HS	CROSSGRIP	XF	XM47	BIBSTEEL AT	BIBSTEEL HS	TWEEL AT	TWEEL HST	POWER CL	POWER DIGGER	
 Backhoe Loaders	X	X	X	X		X	X	X				X	Front: 340/80R18 (12.5/80-18) Front: 300/70R16.5 (12-16.5) Rear: 500/70R24 (19.5-24) Rear: 540/70R24 (21L-24) Rear: 440/80R24 (16.9-24)
 Compact Wheel Loaders	X		X	X		X	X	X				X	340/80R18 (12.5/80-18) 400/70R18 (16.0/70-18) 400/70R20 (16.0/70-20)
 Telehandlers	X		X	X		X	X	X				X	400/80-24 (15.5/80-24) 460/70-24 (17.5-24) 500/70R24 (19.5-24)
 Wheeled Excavators					X							X	10.00-20 445/70R19.5 (18R19.5) 445/70R22.5 (18R22.5)
 Skid Steers							X	X	X	X			260/70R16.5 (10-16.5) 300/70R16.5 (12-16.5) 360/70R16.5 (14-17.5)
 Small Tractors	X			X									Front: 250/80R16 Rear: 400/80R24 (15.5/80R24)

* Not all sizes are available in each tire range

RANGES BY SIZE

RIM	PRODUCT LINE	METRIC	STANDARD	CONSTRUCTION	TREAD DEPTH (32nds)	WEIGHT (LBS)	MSPN
15	BibSteel AT	210/70R15	27x8.5 R15	Radial	19	44	20011
16	Crossgrip	250/80R16	-	Radial	21	62	97221
	XM27	11LR16	11 LR16	Radial	29	65	13902
16.5	BibSteel AT	260/70R16.5	10 R16.5	Radial	25	71	19038
	BibSteel AT	300/70R16.5	12 R16.5	Radial	29	91	34034
	Bibsteel HS	260/70R16.5	10 R16.5	Radial	23	71	38281
	Bibsteel HS	300/70R16.5	12 R16.5	Radial	26	95	84590
	Tweel SSL 2 Hard Surface Traction	12N16.5	12N16.5	Airless Radial	48	240	45604
	Tweel Hard Surface Traction 2-Piece	12N16.5	12N16.5	Airless Radial	48	255	56289
	Tweel SSL 2 All Terrain	10N16.5	10N16.5	Airless Radial	31	160	93405
	Tweel SSL 2 All Terrain	12N16.5	12N16.5	Airless Radial	31	211	07013
	Tweel SSL All Terrain 2-Piece	12N16.5	12N16.5	Airless Radial	31	226	76642
17.5	Bibsteel AT	360/70R17.5	14 R17.5	Radial	33	126	17395
18	Bibload HS	340/80R18	12.5/80 R18	Radial	35	121	66605
	Bibload HS	400/70R18	16.0/70 R18	Radial	37	140	09464
	Crossgrip	340/80 R18	12.5/80 R18	Radial	26	115	31129
	Power CL	280/80-18	10.5/80-18	Bias	33	84	38882
	Power CL	340/80-18	12.5/80-18	Bias	30	114	04967
	XMCL	280/80R18	10.5/80 R18	Radial	35	96	25391
	XMCL	340/80R18	12.5/80 R18	Radial	38	124	24643
	XMCL	400/70R18	16.0/70 R18	Radial	38	140	39817
19.5	XF	445/70R19.5	18 R19.5	Radial	23	240	81617
20	Bibload HS	340/80R20	12.5/80 R20	Radial	35	130	23767
	Bibload HS	400/70R20	16.0/70 R20	Radial	37	150	18143
	Power CL	280/80-20	10.5/80-20	Bias	34	93	28486
	Power CL	340/80-20	12.5/80-20	Bias	31	119	56730
	Power CL	400/70-20	16.0/70-20	Bias	37	146	18007
	Power Digger	10.00-20	-	Bias	19	101	03227
	XM47	405/70R20	16.0/70 R20	Radial	35	153	43043
	XM47	425/75R20	16.5/75 R20	Radial	38	181	75328
	XMCL	280/80R20	10.5/80 R20	Radial	37	104	32621
	XMCL	340/80R20	12.5/80 R20	Radial	37	135	00733
	XMCL	380/75R20	14.5/75 R20	Radial	42	152	03424
	XMCL	400/70R20	16.0/70 R20	Radial	42	154	02871
	XMCL	420/75R20	16.5/75 R20	Radial	42	182	19152

RANGES BY SIZE

RIM	PRODUCT LINE	METRIC	STANDARD	CONSTRUCTION	TREAD DEPTH (32nds)	WEIGHT (LBS)	MSPN
22.5	XF	445/70R22.5	18 R 22.5	Radial	25	265	33819
24	Bibload HS	440/80R24	16.9 R24	Radial	40	240	23762
	Bibload HS	460/70R24	17.5 LR24	Radial	42	223	27534
	Bibload HS	500/70R24	19.5 LR 24	Radial	40	251	19122
	Bibload HS	540/70R24	21 LR24	Radial	42	294	34928
	Crossgrip	360/80R24	13.6 R24	Radial	33	194	76135
	Crossgrip	400/80R24	16.0 R24	Radial	33	194	76135
	Crossgrip	440/80R24	16.9 R24	Radial	33	240	74806
	Crossgrip	460/70 R24	17.5 R24	Radial	33	198	11050
	Crossgrip	500/70 R24	19.5 R24	Radial	33	243	63574
	Power CL	400/80-24	15.5/80-24	Bias	37	185	53837
	Power CL	400/70-24	16.0/70-24	Bias	37	174	60752
	Power CL	440/80-24	16.9-24	Bias	37	228	56443
	Power CL	460/70-24	17.5 L 24	Bias	37	190	86617
	Power CL	500/70-24	19.5 L 24	Bias	37	215	06567
	XM47	445/70R24	17.5 LR24	Radial	43	205	45627
	XM47	495/70R24	19.5 LR24	Radial	44	259	88892
	XMCL	400/70R24	16.0/70 R24	Radial	42	176	92225
	XMCL	440/80R24	16.9 R24	Radial	45	243	34933
	XMCL	460/70R24	17.5 LR24	Radial	45	222	70333
	XMCL	500/70R24	19.5 LR 24	Radial	45	253	89582
XMCL	540/70R24	21 LR24	Radial	48	294	58268	
26	Bibload HS	480/80R26	18.4 R26	Radial	42	285	46166
	Power CL	480/80-26	18.4-26	Bias	35	240	32114
	XMCL	480/80R26	18.4 R26	Radial	45	287	22312
28	Bibload HS	440/80R28	16.9 R28	Radial	42	267	49461
	Crossgrip	400/80 R28	16.0/80 R28	Radial	33	212	38141
	Crossgrip	440/80R28	16.9 R28	Radial	33	254	52613
	Power CL	440/80-28	16.9-28	Bias	37	225	95541
	XMCL	440/80R28	16.9 R28	Radial	45	268	94482
34	Crossgrip	440/80 R34	16.9 R34	Radial	35	820	20271
	Crossgrip	480/80 R34	18.4 R34	Radial	35	324	56587
38	Crossgrip	480/80 R38	18.4 R38	Radial	37	353	06819

SIZE EQUIVALENCY CHART

EQUIVALENT SIZES				MICHELIN COMPACT LINE											
Rims	Standard	Metric 1	Metric 2	XMCL	XM27	BIBLOAD HS	CROSSGRIP	XF	XM47	BIBSTEEL AT	BIBSTEEL HS	TWEEL AT	TWEEL HST	POWER CL *	POWER DIGGER *
15	27x8.5 R 15	210/70 R 15	215/70 R 15							X					
16	7.5 R 16	250/80 R 16					X								
	11 LR 16				X										
16.5	10 R 16.5	260/70 R 16.5	265/70 R 16.5							X	X	X	X		
	12 R 16.5	300/70 R 16.5	305/70 R 16.5							X	X	X	X		
17.5	14 R 17.5	360/70 R 17.5								X					
18	10.5/80 R 18	280/80 R 18		X										X	
	12.5/80 R 18	340/80 R 18	335/80 R 18	X		X	X							X	
		400/70 R 18	405/70 R 18	X		X									
19.5	18 R 19.5	445/70 R 19.5					X								
20	10.5/80 R 20	280/80 R 20	335/80 R 20	X										X	
	12.5/80 R 20	340/80 R 20		X		X								X	
	14.5 R 20	380/75 R 20	375/75 R 20	X											
	16.0/70 R 20	400/70 R 20	405/70 R 20	X		X			X					X	
	16.5/75 R 20	425/75 R 20		X					X						
	10.00 R 20														X
22.5	18 R 22.5	445/70 R 22.5						X							
24	13.6 R24	360/80 R24					X								
	15.5/80 R24	400/80 R 24												X	
	16.0/70 R 24	400/70 R 24		X										X	
	16.0 R24	400/80 R24					X								
	16.9 R 24	440/80 R24		X		X	X							X	
	17.5 LR 24	460/70 R 24	445/70 R 24	X		X	X		X					X	
	19.5 LR 24	500/70 R 24	495/70 R 24	X		X	X		X					X	
	21 LR 24	540/70 R 24		X		X									
26	18.4 R 26	480/80 R 26		X		X								X	
28	16.0/80 R28	400/80 R28					X								
	16.9 R 28	440/80 R 28		X		X	X							X	
30	16.9 R 30	420/80 R 30												X	
34	16.9 R34	440/80 R34					X								
	18.4 R34	480/80 R34					X								
38	18.4 R38	480/80 R38					X								

* Bias tire



XMCL™

EXCEPTIONALLY RESISTANT TO CUTS & EXCELLENT TRACTION EVEN IN WET & DIFFICULT CONDITIONS



Backhoe Loaders



Compact Wheel Loaders



Telehandlers



RADIAL TIRE

- Up to 46% more service life vs MICHELIN bas tire



TRACTION

- Effectiveness on soft ground



PRODUCTIVITY

- Reinforced sidewall & metal top plies for puncture resistance



COMFORT

- Smoother ride



STEEL CROWN BELTS

- Great stability
- Excellent puncture resistance and better load distribution



SIZES

280/80 R18 132A8/132B IND TL

340/80 R18 143A8/143B IND TL

400/70 R18 147A8/147B IND TL

280/80 R20 133A8/133B IND TL

340/80 R20 144A8/144B IND TL

400/70 R20 149A8/149B IND TL

380/75 R20 148A8/148B IND TL

420/75 R20 154A8/154B IND TL

400/70 R24 152A8/152B IND TL

460/70 R24 159A8/159B IND TL

500/70 R24 164A8/164B IND TL

440/80 R24 161A8/161B IND TL

540/70 R24 168A8/168B IND TL

480/80 R26 167A8/167B IND TL

440/80 R28 156A8/156B IND TL

Tire specifications and pressure table. Load per tire in lbs.*

Rim Size (inch)		Description										MSPN (CAI)			
18		280/80 R18 132A8/132B IND TL 10.5 R18 (Equiv 10PR)										25391 (779803)			
Section Width	Overall Diam. (in.)	Loaded Radius (in.)	Rolling Circum. (in.)	Recommended Rim	Acceptable Rims					Min. Dual Spacing (in.)	75% internal volume (gal.)	Tread depth (32nd in.)			
11	36	16.3	106.6	W9	W10 W8					15.3	17.8	35			
Psi	17	23	29	32	35	38	41	44	46	49	52	55	58	61	64
Stat		3970	4850	5290	5730	6175	6615	7055	7495	7935	8380	8820	9260	9700	10140
6 mph Cyc		2580	3155	3450	3735	4025	4310	4595	4895	5180	5465	5755	6040	6325	6615
15 mph		2335	2765	2975	3185	3395	3605	3825	4035	4255	4465	4685	4895		
20 mph		2250	2670	2865	3075	3285	3495	3695	3900	4110	4310	4520	4720		
25 mph		2095	2480	2680	2865	3065	3250	3450	3640	3835	4025	4220	4410		
30 mph		2095	2480	2680	2865	3065	3250	3450	3640	3835	4025	4220	4410		

Rim Size (inch)		Description										MSPN (CAI)			
18		340/80 R18 143A8/143B IND TL 12.5 R18 (Equiv 12PR)										24643 (100054)			
Section Width	Overall Diam. (in.)	Loaded Radius (in.)	Rolling Circum. (in.)	Recommended Rim	Acceptable Rims					Min. Dual Spacing (in.)	75% internal volume (gal.)	Tread depth (32nd in.)			
14	39	17.6	116.5	11	11SDC 12 12SDC W10 W11					18.2	28.1	39			
Psi	17	23	29	32	35	38	41	44	46	49	52	55	58	61	64
Stat		5400	6605	7210	7805	8410	9015	9610	10220	10815	11420	12025	12620	13230	13825
6 mph Cyc		3525	4310	4705	5095	5490	5885	6270	6670	7055	7450	7835	8235	8630	9015
15 mph		3195	3780	4070	4355	4640	4940	5225	5510	5800	6085	6370	6660		
20 mph		3065	3625	3915	4190	4475	4750	5040	5315	5600	5875	6160	6435		
25 mph		2910	3415	3670	3925	4180	4430	4685	4940	5205	5480	5745	6010		
30 mph		2910	3415	3670	3925	4180	4430	4685	4940	5205	5480	5745	6010		

Rim Size (inch)		Description										MSPN (CAI)			
18		400/70 R18 147A8/147B IND TL 405/70 R18 (Equiv 14PR)										39817 (133035)			
Section Width	Overall Diam. (in.)	Loaded Radius (in.)	Rolling Circum. (in.)	Recommended Rim	Acceptable Rims					Min. Dual Spacing (in.)	75% internal volume (gal.)	Tread depth (32nd in.)			
16	40	17.9	118.4	13	12 12SDC 13.00 W13					21.1	34.1	39			
Psi	17	23	29	32	35	38	41	44	46	49	52	55	58	61	64
Stat		6175	7495	8155	8820	9480	10140	10870	11605	12335	13060	13700	14330	14970	15600
6 mph Cyc		4025	4885	5325	5755	6185	6615	7090	7575	8045	8520	8930	9350	9765	10175
15 mph		3680	4290	4595	4895	5245	5600	5950	6305	6615	6925	7220	7530		
20 mph		3540	4135	4420	4720	5060	5400	5730	6075	6370	6670	6955	7255		
25 mph		3305	3860	4135	4410	4730	5050	5355	5675	5950	6230	6505	6780		
30 mph		3305	3860	4135	4410	4730	5050	5355	5675	5950	6230	6505	6780		

Rim Size (inch)		Description										MSPN (CAI)			
20		280/80 R20 133A8/133B IND TL 10.5 R20 (Equiv 10PR)										32621 (747442)			
Section Width	Overall Diam. (in.)	Loaded Radius (in.)	Rolling Circum. (in.)	Recommended Rim	Acceptable Rims					Min. Dual Spacing (in.)	75% internal volume (gal.)	Tread depth (32nd in.)			
11	38	17.3	112.6	W9	W10 W8					15.3	19.2	39			
Psi	17	23	29	32	35	38	41	44	46	49	52	55	58	61	64
Stat		4080	4980	5445	5895	6350	6800	7255	7715	8170	8620	9085	9535	10000	10450
6 mph Cyc		2670	3265	3550	3845	4145	4440	4740	5025	5325	5620	5920	6215	6515	6810
15 mph		2405	2845	3065	3285	3505	3725	3945	4165	4385	4610	4830	5050		
20 mph		2315	2745	2955	3165	3375	3585	3805	4010	4220	4430	4640	4850		
25 mph		2150	2545	2745	2955	3155	3350	3550	3750	3945	4145	4345	4540		
30 mph		2150	2545	2745	2955	3155	3350	3550	3750	3945	4145	4345	4540		

* Refer to the notes at the end of the tables of this range

Tire specifications and pressure table. Load per tire in lbs.*

Rim Size (inch)		Description										MSPN (CAI)			
20		340/80 R20 144A8/144B IND TL 12.5 R20 (Equiv 12PR)										00733 (948730)			
Section Width	Overall Diam. (in.)	Loaded Radius (in.)	Rolling Circum. (in.)	Recommended Rim	Acceptable Rims						Min. Dual Spacing (in.)	75% internal volume (gal.)	Tread depth (32nd in.)		
14	41	18.7	122.8	11	11SDC 12 12SDC W10 W11						18.2	30.1	39		
Psi	17	23	29	32	35	38	41	44	46	49	52	55	58	61	64
Stat		5555	6790	7410	8025	8640	9260	9875	10495	11110	11730	12345	12965	13580	14200
6 mph Cyc		3615	4420	4830	5225	5635	6040	6435	6845	7240	7650	8045	8455	8865	9260
15 mph		3285	3880	4180	4475	4775	5070	5370	5665	5965	6260	6560	6855		
20 mph		3155	3725	4010	4300	4585	4870	5160	5445	5745	6030	6325	6615		
25 mph		3000	3515	3780	4035	4300	4555	4815	5070	5345	5620	5895	6175		
30 mph		3000	3515	3780	4035	4300	4555	4815	5070	5345	5620	5895	6175		

Rim Size (inch)		Description										MSPN (CAI)			
20		380/75 R20 148A8/148B IND TL 14.5 R20 (Equiv 12PR)										03424 (187752)			
Section Width	Overall Diam. (in.)	Loaded Radius (in.)	Rolling Circum. (in.)	Recommended Rim	Acceptable Rims						Min. Dual Spacing (in.)	75% internal volume (gal.)	Tread depth (32nd in.)		
15	42	18.9	125.2	W12	11 12 W11						20	35.9	42		
Psi	17	23	29	32	35	38	41	44	46	49	52	55	58	61	64
Stat		6260	7650	8345	9040	9735	10430	11120	11815	12510	13205	13900	14595	15290	15985
6 mph Cyc		4080	4980	5435	5885	6340	6790	7240	7695	8145	8600	9060	9515	9975	10430
15 mph		3680	4355	4695	5025	5370	5700	6040	6370	6715	7045	7385	7715		
20 mph		3550	4200	4520	4840	5160	5490	5810	6130	6460	6780	7110	7430		
25 mph		3305	3900	4200	4495	4785	5080	5380	5675	5995	6315	6625	6945		
30 mph		3305	3900	4200	4495	4785	5080	5380	5675	5995	6315	6625	6945		

Rim Size (inch)		Description										MSPN (CAI)			
20		400/70 R20 149A8/149B IND TL 16.0/70 R20 (Equiv 16PR)										02871 (474495)			
Section Width	Overall Diam. (in.)	Loaded Radius (in.)	Rolling Circum. (in.)	Recommended Rim	Acceptable Rims						Min. Dual Spacing (in.)	75% internal volume (gal.)	Tread depth (32nd in.)		
16	42	18.9	125.1	W13	12 12SDC 13 13SDC 14 DW13						21.1	36.8	42		
Psi	17	23	29	32	35	38	41	44	46	49	52	55	58	61	64
Stat		6460	7895	8610	9325	10040	10760	11475	12190	12910	13625	14340	15060	15775	16490
6 mph Cyc		4210	5150	5610	6085	6550	7010	7485	7950	8420	8885	9360	9820	10295	10760
15 mph		3815	4510	4850	5190	5535	5885	6230	6570	6925	7265	7615	7960		
20 mph		3660	4330	4665	4995	5325	5665	5995	6325	6670	7000	7340	7670		
25 mph		3415	4025	4330	4630	4940	5235	5545	5840	6175	6505	6835	7165		
30 mph		3415	4025	4330	4630	4940	5235	5545	5840	6175	6505	6835	7165		

Rim Size (inch)		Description										MSPN (CAI)			
20		420/75 R20 154A8/154B IND TL 16.5/75 R20 (Equiv 18PR)										19152 (967201)			
Section Width	Overall Diam. (in.)	Loaded Radius (in.)	Rolling Circum. (in.)	Recommended Rim	Acceptable Rims						Min. Dual Spacing (in.)	75% internal volume (gal.)	Tread depth (32nd in.)		
17	45	20	133	13	12 12SDC 13SDC 14						21.7	45.4	42		
Psi	17	23	29	32	35	38	41	44	46	49	52	55	58	61	64
Stat		7450	9105	9930	10760	11585	12410	13240	14065	14890	15720	16545	17370	18200	19025
6 mph Cyc		4850	5930	6470	7010	7550	8090	8630	9170	9710	10250	10790	11330	11870	12410
15 mph		4385	5190	5590	5985	6380	6790	7185	7585	7980	8380	8775	9170		
20 mph		4235	5005	5380	5765	6150	6535	6910	7295	7685	8070	8455	8840		
25 mph		3970	4675	5025	5380	5720	6075	6425	6780	7155	7530	7895	8265		
30 mph		3970	4675	5025	5380	5720	6075	6425	6780	7155	7530	7895	8265		

Tire specifications and pressure table. Load per tire in lbs.*

Rim Size (inch)		Description										MSPN (CAI)			
24		400/70 R24 152A8/152B IND TL 16.0/70 R24 (Equiv 16PR)										92225 (178690)			
Section Width	Overall Diam. (in.)	Loaded Radius (in.)	Rolling Circum. (in.)	Recommended Rim	Acceptable Rims					Min. Dual Spacing (in.)	75% internal volume (gal.)	Tread depth (32nd in.)			
16	46	20.9	137.2	DW13L	13 13SDC DW12 DW13 DW14L					21.1	41.4	42			
Psi	17	23	29	32	35	38	41	44	46	49	52	55	58	61	64
Stat		6900	8465	9235	10020	10805	11585	12370	13140	13920	14705	15530	16360	17175	18000
6 mph Cyc		4495	5510	6030	6535	7045	7550	8060	8575	9085	9590	10130	10670	11200	11740
15 mph		4035	4805	5180	5565	5950	6340	6715	7100	7495	7895	8290	8685		
20 mph		3890	4630	5005	5370	5745	6105	6480	6845	7230	7615	7990	8380		
25 mph		3640	4330	4675	5015	5355	5710	6050	6395	6755	7110	7475	7825		
30 mph		3640	4330	4675	5015	5355	5710	6050	6395	6755	7110	7475	7825		

Rim Size (inch)		Description										MSPN (CAI)			
24		440/80 R24 161A8/161B IND TL 16.9 R24 (Equiv 18PR)										34933 (954749)			
Section Width	Overall Diam. (in.)	Loaded Radius (in.)	Rolling Circum. (in.)	Recommended Rim	Acceptable Rims					Min. Dual Spacing (in.)	75% internal volume (gal.)	Tread depth (32nd in.)			
17	52	23.3	153.8	DW14L	14 DW15L TW14L					22.8	62.2	45			
Psi	17	23	29	32	35	38	41	44	46	49	52	55	58	61	64
Stat		9170	11210	12235	13250	14275	15300	16315	17340	18355	19380	20405	21420	22445	23455
6 mph Cyc		5975	7310	7970	8640	9305	9965	10635	11300	11970	12630	13295	13965	14640	15300
15 mph		5425	6405	6900	7385	7880	8365	8865	9350	9845	10330	10825	11310		
20 mph		5225	6175	6645	7120	7595	8070	8545	9015	9490	9965	10440	10915		
25 mph		4940	5840	6295	6745	7185	7640	8090	8545	8960	9370	9790	10195		
30 mph		4940	5840	6295	6745	7185	7640	8090	8545	8960	9370	9790	10195		

Rim Size (inch)		Description										MSPN (CAI)			
24		460/70 R24 159A8/159B IND TL 17.5 LR24 (Equiv 18PR)										70333 (244268)			
Section Width	Overall Diam. (in.)	Loaded Radius (in.)	Rolling Circum. (in.)	Recommended Rim	Acceptable Rims					Min. Dual Spacing (in.)	75% internal volume (gal.)	Tread depth (32nd in.)			
18	49	22.1	146	DW15L	14 16 DW14L DW16L TW14L					23.5	57.6	45			
Psi	17	23	29	32	35	38	41	44	46	49	52	55	58	61	64
Stat		8685	10615	11575	12545	13505	14460	15430	16390	17360	18320	19290	20250	21220	22180
6 mph Cyc		5665	6925	7550	8180	8805	9435	10065	10690	11320	11950	12575	13205	13835	14460
15 mph		5115	6050	6515	6980	7440	7905	8380	8840	9315	9780	10250	10715		
20 mph		4940	5840	6285	6735	7185	7630	8080	8530	8985	9425	9875	10320		
25 mph		4675	5525	5940	6360	6780	7210	7630	8045	8445	8850	9250	9645		
30 mph		4675	5525	5940	6360	6780	7210	7630	8045	8445	8850	9250	9645		

Rim Size (inch)		Description										MSPN (CAI)			
24		500/70 R24 164A8/164B IND TL 19.5 LR24 (Equiv 20PR)										89582 (542794)			
Section Width	Overall Diam. (in.)	Loaded Radius (in.)	Rolling Circum. (in.)	Recommended Rim	Acceptable Rims					Min. Dual Spacing (in.)	75% internal volume (gal.)	Tread depth (32nd in.)			
20	51	23	152.2	DW16L	16 DW15L					25.7	70.1	45			
Psi	17	23	29	32	35	38	41	44	46	49	52	55	58	61	64
Stat		9920	12125	13230	14330	15430	16535	17635	18740	19840	20945	22045	23150	24250	25355
6 mph Cyc		6460	7905	8620	9350	10065	10780	11510	12225	12950	13670	14385	15100	15820	16535
15 mph		5840	6910	7440	7970	8500	9040	9570	10095	10635	11165	11705	12235		
20 mph		5645	6670	7185	7695	8210	8720	9235	9745	10265	10770	11290	11795		
25 mph		5205	6175	6660	7155	7640	8125	8610	9095	9580	10065	10540	11025		
30 mph		5205	6175	6660	7155	7640	8125	8610	9095	9580	10065	10540	11025		

Tire specifications and pressure table. Load per tire in lbs.*

Rim Size (inch)		Description										MSPN (CAI)			
24		540/70 R24 168A8/168B IND TL 21 LR24 (Equiv 20PR)										58268 (959128)			
Section Width	Overall Diam. (in.)	Loaded Radius (in.)	Rolling Circum. (in.)	Recommended Rim	Acceptable Rims						Min. Dual Spacing (in.)	75% internal volume (gal.)	Tread depth (32nd in.)		
22	53	23.9	158.5	DW18L	DW16L						27.5	83.6	45		
Psi	17	23	29	32	35	38	41	44	46	49	52	55	58	61	64
Stat		11055	13030	14020	15000	15995	16975	17970	18950	19940	20920	22785	24660	26535	28395
6 mph Cyc		7210	8500	9140	9790	10430	11065	11720	12355	13005	13645	14860	16085	17305	18520
15 mph		6480	7695	8300	8905	9500	10110	10715	11320	11915	12520	13120	13715		
20 mph		6260	7430	8005	8585	9170	9755	10330	10915	11495	12070	12655	13230		
25 mph		5840	6935	7475	8025	8565	9105	9655	10195	10735	11275	11805	12345		
30 mph		5840	6935	7475	8025	8565	9105	9655	10195	10735	11275	11805	12345		

Rim Size (inch)		Description										MSPN (CAI)			
26		480/80 R26 167A8/167B IND TL 18.4 R26 (Equiv 20PR)										22312 (425979)			
Section Width	Overall Diam. (in.)	Loaded Radius (in.)	Rolling Circum. (in.)	Recommended Rim	Acceptable Rims						Min. Dual Spacing (in.)	75% internal volume (gal.)	Tread depth (32nd in.)		
19	56	25	166.1	DW15L	DW16L						24.6	79.8	45		
Psi	17	23	29	32	35	38	41	44	46	49	52	55	58	61	64
Stat		10805	13205	14405	15610	16810	18010	19215	20415	21615	22820	24020	25230	26435	27635
6 mph Cyc		7055	8620	9405	10185	10970	11750	12535	13315	14100	14880	16445	18025		
15 mph		6370	7540	8115	8695	9280	9865	10440	11025	11605	12180	12765	13340		
20 mph		6150	7275	7825	8390	8950	9515	10065	10625	11190	11750	12300	12865		
25 mph		5675	6735	7265	7805	8335	8865	9390	9920	10450	10970	11495	12015		
30 mph		5675	6735	7265	7805	8335	8865	9390	9920	10450	10970	11495	12015		

Rim Size (inch)		Description										MSPN (CAI)			
28		440/80 R28 156A8/156B IND TL 16.9 R28 (Equiv 18PR)										94482 (316223)			
Section Width	Overall Diam. (in.)	Loaded Radius (in.)	Rolling Circum. (in.)	Recommended Rim	Acceptable Rims						Min. Dual Spacing (in.)	75% internal volume (gal.)	Tread depth (32nd in.)		
18	55	25.2	165.4	DW14L	DW15L						22.8	68.7	45		
Psi	17	23	29	32	35	38	41	44	46	49	52	55	58	61	64
Stat		9610	11750	12810	13880	14945	16015	17085	18145	19215	20285				
6 mph Cyc		6260	7650	8355	9050	9745	10440	11135	11840	12535	13230				
15 mph		5665	6700	7210	7725	8245	8750	9270	9790						
20 mph		5465	6460	6955	7450	7950	8445	8940	9435						
25 mph		5070	6010	6480	6945	7420	7880	8355	8820						
30 mph		5070	6010	6480	6945	7420	7880	8355	8820						

***IMPORTANT:**

The inflation pressure must always be appropriate for the load per tire, the speed of travel and the work to be done. Our recommendations above are provided subject to changes made after the date of publication of these tables. Technical data is subject to change without prior notice.

- When using single tire configuration:
 - add 6 psi for use on slopes of more than 20%
 - add 6 psi for intense road use exceeding 50%
- Stat: static load.
- 6 mph Cyc: max. speed 6 mph with cyclic load.



XM27™

EXCEPTIONALLY RESISTANT TO CUTS
& EXCELLENT TRACTION EVEN IN
WET & DIFFICULT CONDITIONS



RADIAL TIRE

- Up to 46% more service life vs MICHELIN Bias tire



TRACTION

- Effectiveness on soft ground



PRODUCTIVITY

- Reinforced sidewall & metal top plies for puncture resistance



COMFORT

- Smoother ride



Tire specifications and pressure table. Load per tire in lbs.*

Rim Size (inch)		Description					MSPN (CAI)		
16		11 LR16 122A8 IND TL					13902 (123207)		
Section Width	Overall Diam. (in.)	Loaded Radius (in.)	Rolling Circum. (in.)	Recommended Rim	Acceptable Rims		Min. Dual Spacing (in.)	75% internal volume (gal.)	Tread depth (32nd in.)
11	33	14.8	99	W8	W10L		15.2	15.8	29
Psi	17	23	29	32	35	38			
6 mph	2790	3375	3945	4235	4530	4815			
20 mph	2070	2570	3055	3305	3550				
25 mph	1940	2390	2855	3075	3305				

***IMPORTANT:**

The inflation pressure must always be appropriate for the load per tire, the speed of travel and the work to be done. Our recommendations above are provided subject to changes made after the date of publication of these tables. Technical data is subject to change without prior notice.

- When using single tire configuration:
 - add 6 psi for use on slopes of more than 20%
 - add 6 psi for intense road use exceeding 50%
- Stat: static load.



BIBLOAD® HARD SURFACE

NON-DIRECTIONAL
STEEL-BELTED RADIAL TIRE



Backhoe Loaders



Compact Wheel Loaders



Telehandlers



PROVEN CASING DURABILITY IN ALL APPLICATIONS

- Uses the same proven casing of the XMCL with added reinforcements in the shoulder area for protection



IMPROVED LATERAL TRACTION AND GRIP VS STANDARD R4 TREAD DESIGN

- Offers a tread face with up to 30% more tread surface than a standard R4 tread pattern



PATENTED DIAMOND LUG PATTERN OFFERS MULTIPLE BITING EDGES FOR TRACTION

- Constant traction provided by two sections of lug that are always in contact with the surface



SUPERIOR RIDE QUALITY

- Radial construction offers a comfortable ride in any condition



SIZES

340/80 R18 143A8/143B IND TL

460/70 R24 159A8/159B IND TL

480/80 R26 167A8/167B IND TL

400/70 R18 147A8/147B IND TL

440/80 R24 161A8/161B IND TL

440/80 R28 163A8/163B IND TL

340/80 R20 144A8/144B IND TL

500/70 R24 164A8/164B IND TL

400/70 R20 149A8/149B IND TL

540/70 R24 168A8/168B IND TL

BIBLOAD® HARD SURFACE

Tire specifications and pressure table. Load per tire in lbs.*

Rim Size (inch)		Description									MSPN (CAI)				
18		340/80 R18 143A8/143B IND TL 12.5 R18 (Equiv 12PR)									66605 (415829)				
Section Width	Overall Diam. (in.)	Loaded Radius (in.)	Rolling Circum. (in.)	Recommended Rim	Acceptable Rims					Min. Dual Spacing (in.)	75% internal volume (gal.)	Tread depth (32nd in.)			
13	39	17.6	116	W11	11 11SDC 12 12SDC W10					18.2	28.1	35			
Psi	23	26	29	32	35	38	41	44	46	49	52	55	58	61	64
Stat	5400	6010	6605	7210	7805	8410	9015	9610	10220	10815	11420	12025	12620	13230	13825
6 mph Cyc	3525	3925	4310	4705	5095	5490	5885	6270	6670	7055	7450	7835	8235	8630	9015
15 mph	3195	3485	3780	4070	4355	4640	4940	5225	5510	5800	6085	6370	6660		
20 mph	3065	3350	3625	3915	4190	4475	4750	5040	5315	5600	5875	6160	6440		
25 mph	2910	3165	3415	3670	3925	4180	4430	4685	4940	5205	5480	5745	6010		
30 mph	2910	3165	3415	3670	3925	4180	4430	4685	4940	5205	5480	5745	6010		

Rim Size (inch)		Description									MSPN (CAI)				
18		400/70 R18 147A8/147B IND TL 405/70 R18 (Equiv 14PR)									09464 (239365)				
Section Width	Overall Diam. (in.)	Loaded Radius (in.)	Rolling Circum. (in.)	Recommended Rim	Acceptable Rims					Min. Dual Spacing (in.)	75% internal volume (gal.)	Tread depth (32nd in.)			
16	39	17.6	117.4	13	12 12SDC 13.00					21.1	34.1	37			
Psi	23	26	29	32	35	38	41	44	46	49	52	55	58	61	64
Stat	6175	6835	7495	8155	8820	9480	10140	10870	11605	12335	13060	13700	14330	14970	15600
6 mph Cyc	4025	4455	4885	5325	5755	6185	6615	7090	7575	8045	8520	8930	9350	9770	10170
15 mph	3680	3990	4290	4595	4895	5245	5600	5950	6305	6615	6925	7220	7530		
20 mph	3540	3835	4135	4420	4720	5060	5400	5730	6075	6370	6670	6955	7250		
25 mph	3305	3585	3860	4135	4410	4730	5050	5355	5675	5950	6230	6505	6780		
30 mph	3305	3585	3860	4135	4410	4730	5050	5355	5675	5950	6230	6505	6780		

Rim Size (inch)		Description									MSPN (CAI)				
20		340/80 R20 144A8/144B IND TL 12.5 R20 (Equiv 12PR)									23767 (991253)				
Section Width	Overall Diam. (in.)	Loaded Radius (in.)	Rolling Circum. (in.)	Recommended Rim	Acceptable Rims					Min. Dual Spacing (in.)	75% internal volume (gal.)	Tread depth (32nd in.)			
14	41	18.6	122	11	11SDC 12 12SDC W10 W11					18.2	30.1	35			
Psi	23	26	29	32	35	38	41	44	46	49	52	55	58	61	64
Stat	5555	6175	6790	7410	8025	8640	9260	9875	10495	11110	11730	12345	12965	13580	14200
6 mph Cyc	3615	4025	4420	4830	5225	5635	6040	6435	6845	7240	7650	8045	8455	8865	9260
15 mph	3285	3585	3880	4180	4475	4775	5070	5370	5665	5965	6260	6560	6855		
20 mph	3155	3440	3725	4010	4300	4585	4870	5160	5445	5745	6030	6325	6615		
25 mph	3000	3265	3515	3780	4035	4300	4555	4815	5070	5345	5620	5895	6175		
30 mph	3000	3265	3515	3780	4035	4300	4555	4815	5070	5345	5620	5895	6175		

Rim Size (inch)		Description									MSPN (CAI)				
20		400/70 R20 149A8/149B IND TL 16.0/70 R20 (Equiv 16PR)									18143 (793611)				
Section Width	Overall Diam. (in.)	Loaded Radius (in.)	Rolling Circum. (in.)	Recommended Rim	Acceptable Rims					Min. Dual Spacing (in.)	75% internal volume (gal.)	Tread depth (32nd in.)			
16	42	18.9	125	W13	12 12SDC 13 13SDC 14 DW13					21.1	36.8	37			
Psi	23	26	29	32	35	38	41	44	46	49	52	55	58	61	64
Stat	6460	7175	7895	8610	9325	10040	10760	11475	12190	12910	13625	14340	15060	15775	16490
6 mph Cyc	4210	4675	5150	5610	6085	6550	7010	7485	7950	8420	8885	9360	9820	10295	10760
15 mph	3815	4155	4510	4850	5190	5535	5885	6230	6570	6925	7265	7615	7960		
20 mph	3660	3990	4330	4665	4995	5325	5665	5995	6325	6670	7000	7340	7675		
25 mph	3415	3725	4025	4330	4630	4940	5235	5545	5840	6175	6505	6835	7165		
30 mph	3415	3725	4025	4330	4630	4940	5235	5545	5840	6175	6505	6835	7165		

* Refer to the notes at the end of the tables of this range

BIBLOAD® HARD SURFACE

Tire specifications and pressure table. Load per tire in lbs.*

Rim Size (inch)		Description										MSPN (CAI)			
24		440/80 R24 161A8/161B IND TL 16.9 R24 (Equiv 18PR)										23762 (814805)			
Section Width	Overall Diam. (in.)	Loaded Radius (in.)	Rolling Circum. (in.)	Recommended Rim	Acceptable Rims					Min. Dual Spacing (in.)	75% internal volume (gal.)	Tread depth (32nd in.)			
18	51	23	152	DW14L	14 DW15L					22.8	61.8	40			
Psi	23	26	29	32	35	38	41	44	46	49	52	55	58	61	64
Stat	9380	10405	11430	12455	13480	14515	15545	16570	17595	18620	19645	20600	21550	22510	23460
6 mph Cyc	6120	6790	7450	8125	8795	9470	10130	10805	11475	12135	12810	13435	14055	14685	15300
15 mph	5510	5995	6470	6955	7430	7915	8390	8875	9350	9865	10375	10890	11400		
20 mph	5270	5800	6315	6845	7365	7895	8410	8940	9460	9890	10320	10750	11180		
25 mph	4805	5235	5675	6105	6535	6965	7395	7835	8265	8750	9235	9710	10195		
30 mph	4805	5235	5675	6105	6535	6965	7395	7835	8265	8750	9235	9710	10195		

Rim Size (inch)		Description										MSPN (CAI)			
24		460/70 R24 159A8/159B IND TL 17.5 LR24 (Equiv 18PR)										27534 (372690)			
Section Width	Overall Diam. (in.)	Loaded Radius (in.)	Rolling Circum. (in.)	Recommended Rim	Acceptable Rims					Min. Dual Spacing (in.)	75% internal volume (gal.)	Tread depth (32nd in.)			
18	49	22	145.2	DW15L	14 16 DW14L DW16L					23.5	57.6	42			
Psi	23	26	29	32	35	38	41	44	46	49	52	55	58	61	64
Stat	8685	9645	10615	11575	12545	13505	14460	15430	16390	17360	18320	19290	20250	21220	22180
6 mph Cyc	5665	6295	6925	7550	8180	8805	9435	10065	10690	11320	11950	12575	13205	13835	14465
15 mph	5115	5580	6050	6515	6980	7440	7905	8380	8840	9315	9780	10250	10715		
20 mph	4940	5390	5840	6285	6735	7185	7630	8080	8530	8985	9425	9875	10320		
25 mph	4675	5095	5525	5940	6360	6780	7210	7630	8045	8445	8850	9250	9645		
30 mph	4675	5095	5525	5940	6360	6780	7210	7630	8045	8445	8850	9250	9645		

Rim Size (inch)		Description										MSPN (CAI)			
24		500/70 R24 164A8/164B IND TL 19.5 LR24 (Equiv 20PR)										19122 (346709)			
Section Width	Overall Diam. (in.)	Loaded Radius (in.)	Rolling Circum. (in.)	Recommended Rim	Acceptable Rims					Min. Dual Spacing (in.)	75% internal volume (gal.)	Tread depth (32nd in.)			
20	51	23.4	152.5	DW16L	DW15L TW16L					25.7	70.1	40			
Psi	23	26	29	32	35	38	41	44	46	49	52	55	58	61	64
Stat	9920	11025	12125	13230	14330	15430	16535	17635	18740	19840	20945	22045	23150	24250	25355
6 mph Cyc	6460	7175	7905	8620	9350	10065	10780	11510	12225	12950	13670	14385	15100	15820	16535
15 mph	5840	6370	6910	7440	7970	8500	9040	9570	10095	10635	11165	11705	12235		
20 mph	5645	6160	6670	7185	7695	8210	8720	9235	9745	10265	10770	11290	11795		
25 mph	5205	5690	6175	6660	7155	7640	8125	8610	9095	9580	10065	10540	11025		
30 mph	5205	5690	6175	6660	7155	7640	8125	8610	9095	9580	10065	10540	11025		

Rim Size (inch)		Description										MSPN (CAI)			
24		540/70 R24 168A8/168B IND TL 21 LR24 (Equiv 20PR)										34928 (005412)			
Section Width	Overall Diam. (in.)	Loaded Radius (in.)	Rolling Circum. (in.)	Recommended Rim	Acceptable Rims					Min. Dual Spacing (in.)	75% internal volume (gal.)	Tread depth (32nd in.)			
22	53	23.6	156.7	DW18L	DW16L					27.5	83.6	42			
Psi	23	26	29	32	35	38	41	44	46	49	52	55	58	61	64
Stat	11055	12050	13030	14020	15000	15995	16975	17970	18950	19940	20920	22785	24660	26535	28395
6 mph Cyc	7210	7850	8500	9140	9790	10430	11065	11720	12355	13005	13645	14860	16085	17305	18520
15 mph	6480	7090	7695	8300	8905	9500	10110	10715	11320	11915	12520	13120	13715		
20 mph	6260	6845	7430	8005	8585	9170	9755	10330	10915	11495	12070	12655	13230		
25 mph	5840	6380	6935	7475	8025	8565	9105	9655	10195	10735	11275	11805	12345		
30 mph	5840	6380	6935	7475	8025	8565	9105	9655	10195	10735	11275	11805	12345		

BIBLOAD® HARD SURFACE

Tire specifications and pressure table. Load per tire in lbs.*

Rim Size (inch)		Description										MSPN (CAI)			
26		480/80 R26 167A8/167B IND TL 18.4 R26 (Equiv 20PR)										46166 (886709)			
Section Width	Overall Diam. (in.)	Loaded Radius (in.)	Rolling Circum. (in.)	Recommended Rim	Acceptable Rims					Min. Dual Spacing (in.)	75% internal volume (gal.)	Tread depth (32nd in.)			
20	56	25.1	165.9	DW15L	DW16L					22.2	80.2	42			
Psi	23	26	29	32	35	38	41	44	46	49	52	55	58	61	64
Stat	10805	12005	13205	14405	15610	16810	18010	19215	20415	21615	22820	24020	25230	26435	27635
6 mph Cyc	7055	7835	8620	9405	10185	10970	11750	12535	13315	14100	14880	16445	18025		
15 mph	6370	6955	7540	8115	8695	9280	9865	10440	11025	11605	12180	12765	13340		
20 mph	6150	6715	7275	7825	8390	8950	9515	10065	10625	11190	11750	12300	12865		
25 mph	5675	6205	6735	7265	7805	8335	8865	9390	9920	10450	10970	11495	12015		
30 mph	5675	6205	6735	7265	7805	8335	8865	9390	9920	10450	10970	11495	12015		

Rim Size (inch)		Description										MSPN (CAI)			
28		440/80 R28 163A8/163B IND TL 16.9 R28 (Equiv 18PR)										49461 (195802)			
Section Width	Overall Diam. (in.)	Loaded Radius (in.)	Rolling Circum. (in.)	Recommended Rim	Acceptable Rims					Min. Dual Spacing (in.)	75% internal volume (gal.)	Tread depth (32nd in.)			
18	55	25.1	164.9	DW14L	DW15L					22.8	68.3	42			
Psi	23	26	29	32	35	38	41	44	46	49	52	55	58	61	64
Stat	9635	10870	12090	13325	14560	15795	17020	18255	19490	20710	21945	23180	24415	25640	26875
6 mph Cyc	6285	7220	8155	9095	10030	10970	11905	12840	13780	14715	15655	16590	17525		
15 mph	5775	6295	6800	7320	7825	8345	8850	9370	9875	10395	10900	11420	11930		
20 mph	5565	6065	6560	7055	7540	8035	8530	9030	9525	10020	10505	11000	11500		
25 mph	5205	5665	6130	6590	7055	7520	7980	8435	8895	9360	9820	10285	10750		
30 mph	5205	5665	6130	6590	7055	7520	7980	8435	8895	9360	9820	10285	10750		

***IMPORTANT:**

The inflation pressure must always be appropriate for the load per tire, the speed of travel and the work to be done. Our recommendations above are provided subject to changes made after the date of publication of these tables. Technical data is subject to change without prior notice.

- When using single tire configuration:
 - add 6 psi for use on slopes of more than 20%
 - add 6 psi for intense road use exceeding 50%
- Stat: static load.
- 6 mph Cyc: max. speed 6 mph with cyclic load.



CROSSGRIP®

A MULTI-PURPOSE TIRE FOR USE ON THE ROAD, GRASS AND SNOW



Backhoe Loaders



Compact Wheel Loaders



Telehandlers



Tractors



VERSATILITY

- A specific rubber compound designed for all-season use
- Non-directional pattern (no need to dismantle tire from rim when rotating the tires)



PRODUCTIVITY

- Greater load at 40 mph*
- Non-directional tread for excellent precision in forward and reverse gear



TRACTION

- Extra long lug edge with optimized tread pattern for good traction on snow (M+S)



STEEL CROWN BELTS

- Combined with exclusive rubber compounds protect against tread puncture and deliver superior overall performance.



* For the 440/80 R28 163A8/158D IND TL size, the MICHELIN 158D tire can carry 4,250 kg at 65 kph while competitor 151D tires carry 3,450 Kg at 65 kph. Source: ETRTO standard.

SIZES

250/80R16 124A8/120D IND TL

460/70R24 159A8/154D IND TL

480/80R34 164A8/159D IND TL

340/80R18 143A8/138D IND TL

500/70R24 164A8/159D IND TL

480/80R38 166A8/161D IND TL

360/80R24 150A8/145D IND TL

400/80R28 158A8/153D IND TL

540/80 R38 172A8/167D IND TL

400/80R24 156A8/151D IND TL

440/80R28 163A8/158D IND TL

440/80R24 161A8/156D IND TL

440/80R34 159A8/155D IND TL

CROSSGRIP®

Tire specifications and pressure table. Load per tire in lbs.*

Rim Size (inch)		Description										MSPN (CAI)			
16		250/80 R16 124A8/120D IND TL										97221 (564847)			
Section Width	Overall Diam. (in.)	Loaded Radius (in.)	Rolling Circum. (in.)	Recommended Rim	Acceptable Rims					Min. Dual Spacing (in.)	75% internal volume (gal.)	Tread depth (32nd in.)			
10	32	14.3	94.2	W8	W7 W9					13.9	12.7	21			
Psi	12	17	23	29	35	38	41	44	46	49	52	55	58	61	64
Static			3175	3880	4585	4940	5290	5645	5995	6350	6700	7055	7410	7760	8115
6 mph Cyc			2070	2535	2985	3220	3450	3680	3900	4135	4365	4595	4830	5060	5290
15 mph	1380	1630	1875	2215	2555	2725	2900	3065	3230	3405	3570	3750	3915		
20 mph	1355	1585	1810	2125	2460	2610	2780	2945	3095	3265	3430	3585	3750		
25 mph	1290	1500	1710	2015	2315	2470	2625	2765	2920	3075	3230	3375	3525		
30 mph		1500	1710	2015	2315	2470	2625	2765	2920	3075	3230	3375	3525		
40 mph		1200	1465	1740	2005	2140	2280	2415	2545	2680	2820	2955	3085		

Rim Size (inch)		Description										MSPN (CAI)			
18		340/80 R18 143A8/138D IND TL 12.5/80R18										31129 (698283)			
Section Width	Overall Diam. (in.)	Loaded Radius (in.)	Rolling Circum. (in.)	Recommended Rim	Acceptable Rims					Min. Dual Spacing (in.)	75% internal volume (gal.)	Tread depth (32nd in.)			
14	39	17.8	117.1	11	11SDC 12 12SDC W10 W11					18.2	27.9	26			
Psi	12	17	23	29	35	38	41	44	46	49	52	55	58	61	64
Static			5400	6605	7805	8410	9015	9610	10220	10815	11420	12025	12620	13230	13825
6 mph Cyc			3525	4310	5095	5490	5885	6270	6670	7055	7450	7835	8235	8630	9015
15 mph	2335	2765	3195	3780	4355	4640	4940	5225	5510	5800	6095	6380	6670		
20 mph	2305	2690	3065	3625	4190	4475	4750	5040	5315	5590	5875	6150	6425		
25 mph	2205	2555	2910	3415	3925	4180	4430	4685	4940	5205	5480	5745	6010		
30 mph		2555	2910	3430	3945	4200	4465	4720	4970	5235	5490	5755	6010		
40 mph		2050	2500	2945	3385	3605	3825	4045	4265	4485	4705	4925	5150		

Rim Size (inch)		Description										MSPN (CAI)			
24		360/80 R24 150A8/145D IND TL 13.6R24										15827 (514449)			
Section Width	Overall Diam. (in.)	Loaded Radius (in.)	Rolling Circum. (in.)	Recommended Rim	Acceptable Rims					Min. Dual Spacing (in.)	75% internal volume (gal.)	Tread depth (32nd in.)			
14	47	21.5	140	DW12	W11						39.6	33			
Psi	12	17	23	29	35	38	41	44	46	49	52	55	58	61	64
Static			6660	8135	9610	10350	11080	11815	12555	13295	14030	14770	15510	16250	16985
6 mph Cyc			4345	5300	6260	6745	7230	7705	8190	8665	9150	9635	10120	10595	11080
15 mph	2900	3405	3915	4630	5345	5700	6050	6415	6770	7130	7485	7850	8200		
20 mph	2855	3320	3780	4475	5160	5500	5855	6195	6535	6880	7220	7560	7905		
25 mph	2735	3165	3585	4220	4850	5170	5490	5800	6120	6435	6755	7065	7385		
30 mph		3165	3585	4220	4850	5170	5490	5800	6120	6435	6755	7065	7385		
40 mph		2535	3075	3625	4180	4455	4730	5005	5280	5555	5840	6120	6395		

CROSSGRIP®

Tire specifications and pressure table. Load per tire in lbs.*

Rim Size (inch)		Description										MSPN (CAI)			
24		400/80 R24 156A8/151D IND TL 16.0/80R24										76135 (920345)			
Section Width	Overall Diam. (in.)	Loaded Radius (in.)	Rolling Circum. (in.)	Recommended Rim	Acceptable Rims						Min. Dual Spacing (in.)	75% internal volume (gal.)	Tread depth (32nd in.)		
16	49	22.1	145.2	DW13L	DW12 DW14L						21.1	49.3	33		
Psi	12	17	23	29	35	38	41	44	46	49	52	55	58	61	64
Static			7935	9700	11465	12345	13230	14110	14990	15875	16755	17635	18520	19400	20285
6 mph Cyc			5160	6305	7465	8035	8610	9180	9765	10340	10915	11495	12070	12655	13230
15 mph	3415	4045	4675	5400	6120	6480	6835	7200	7560	8080	8610	9125	9645		
20 mph	3360	3955	4540	5260	5975	6340	6690	7055	7410	7915	8435	8940	9460		
25 mph	3220	3760	4300	5050	5810	6185	6560	6935	7310	7695	8070	8445	8820		
30 mph		3760	4300	5050	5810	6185	6560	6935	7310	7695	8070	8445	8820		
40 mph		2985	3615	4255	4905	5225	5545	5865	6185	6535	6900	7255	7605		

Rim Size (inch)		Description										MSPN (CAI)			
24		440/80 R24 161A8/156D IND TL 16.9 R24										74806 (131846)			
Section Width	Overall Diam. (in.)	Loaded Radius (in.)	Rolling Circum. (in.)	Recommended Rim	Acceptable Rims						Min. Dual Spacing (in.)	75% internal volume (gal.)	Tread depth (32nd in.)		
18	52	23.3	153.8	DW14L	14 DW15L						22.8	61.8	33		
Psi	12	17	23	29	35	38	41	44	46	49	52	55	58	61	64
Static			9170	11210	13250	14275	15300	16315	17340	18355	19380	20405	21420	22445	23455
6 mph Cyc			5975	7310	8640	9305	9975	10635	11300	11970	12630	13305	13965	14640	15300
15 mph	3970	4695	5425	6405	7385	7880	8365	8865	9350	9845	10330	10825	11310		
20 mph	3900	4565	5225	6175	7120	7595	8070	8545	9015	9490	9965	10440	10915		
25 mph	3750	4345	4940	5820	6690	7130	7575	8005	8445	8885	9325	9755	10195		
30 mph		4345	4940	5820	6690	7130	7575	8005	8445	8885	9325	9755	10195		
40 mph		3470	4145	4925	5700	6095	6480	6865	7265	7650	8035	8435	8820		

Rim Size (inch)		Description										MSPN (CAI)			
24		460/70 R24 159A8/154D IND TL 17.5R24										11050 (304047)			
Section Width	Overall Diam. (in.)	Loaded Radius (in.)	Rolling Circum. (in.)	Recommended Rim	Acceptable Rims						Min. Dual Spacing (in.)	75% internal volume (gal.)	Tread depth (32nd in.)		
19	49	22.2	146	DW15L	14 16 DW14L DW16A TW14L						23.5	57.4	33		
Psi	12	17	23	29	35	38	41	44	46	49	52	55	58	61	64
Static			8685	10615	12545	13505	14460	15430	16390	17360	18320	19290	20250	21220	22180
6 mph Cyc			5665	6925	8180	8805	9435	10065	10690	11320	11950	12575	13205	13835	14460
15 mph	3780	4455	5115	6050	6980	7440	7905	8380	8840	9315	9780	10250	10715		
20 mph	3715	4330	4940	5840	6735	7185	7630	8080	8530	8985	9425	9875	10320		
25 mph	3560	4125	4675	5500	6325	6745	7165	7575	7990	8400	8820	9225	9645		
30 mph		4125	4675	5500	6325	6745	7165	7575	7990	8400	8820	9225	9645		
40 mph		3305	4010	4720	5435	5785	6140	6495	6845	7210	7560	7915	8265		

* Refer to the notes at the end of the tables of this range

CROSSGRIP®

Tire specifications and pressure table. Load per tire in lbs.*

Rim Size (inch)		Description										MSPN (CAI)			
24		500/70 R24 164A8/159D IND TL 19.5R24										63574 (875270)			
Section Width	Overall Diam. (in.)	Loaded Radius (in.)	Rolling Circum. (in.)	Recommended Rim	Acceptable Rims					Min. Dual Spacing (in.)	75% internal volume (gal.)	Tread depth (32nd in.)			
20	51	22.8	151	DW16A	DW15L DW16L TW16L					25.7	69.7	33			
Psi	12	17	23	29	35	38	41	44	46	49	52	55	58	61	64
Static			9930	12135	14330	15430	16535	17635	18730	19830	20935	22035	23140	24240	25340
6 mph Cyc			6470	7905	9350	10065	10780	11495	12225	12940	13660	14375	15090	15805	16525
15 mph	4300	5070	5840	6910	7980	8510	9040	9580	10110	10650	11175	11720	12245		
20 mph	4235	4940	5645	6670	7705	8210	8730	9235	9755	10265	10780	11290	11795		
25 mph	4055	4705	5345	6295	7240	7715	8190	8655	9125	9600	10075	10550	11025		
30 mph		4705	5345	6295	7240	7715	8190	8655	9125	9600	10075	10550	11025		
40 mph		3770	4585	5400	6205	6615	7020	7420	7825	8235	8640	9040	9445		

Rim Size (inch)		Description										MSPN (CAI)			
28		400/80 R28 158A8/153D IND TL										38141 (219659)			
Section Width	Overall Diam. (in.)	Loaded Radius (in.)	Rolling Circum. (in.)	Recommended Rim	Acceptable Rims					Min. Dual Spacing (in.)	75% internal volume (gal.)	Tread depth (32nd in.)			
16	53	24.3	158.8	DW13	DW11 W12 W13					21.1	42	33			
Psi	12	17	23	29	35	38	41	44	46	49	52	55	58	61	64
Static			8445	10320	12190	13130	14055	14990	15930	16865	17800	18740	19675	20615	21550
6 mph Cyc			5510	6735	7950	8565	9170	9780	10385	11000	11605	12225	12830	13450	14055
15 mph	3660	4320	4970	5875	6780	7230	7685	8135	8585	9040	9500	9955	10405		
20 mph	3605	4200	4795	5665	6550	6980	7420	7850	8290	8720	9160	9590	10020		
25 mph	3450	4000	4540	5345	6150	6560	6955	7365	7760	8170	8565	8975	9370		
30 mph		4000	4540	5345	6150	6560	6955	7365	7760	8170	8565	8975	9370		
40 mph		3210	3900	4595	5280	5620	5975	6315	6660	7000	7350	7695	8035		

Rim Size (inch)		Description										MSPN (CAI)			
28		440/80 R28 163A8/158D IND TL 16.9 R28 (Equiv 18PR)										52613 (439765)			
Section Width	Overall Diam. (in.)	Loaded Radius (in.)	Rolling Circum. (in.)	Recommended Rim	Acceptable Rims					Min. Dual Spacing (in.)	75% internal volume (gal.)	Tread depth (32nd in.)			
18	55	25	165.2	DW14L	DW15L					22.8	68.3	33			
Psi	12	17	23	29	35	38	41	44	46	49	52	55	58	61	64
Static			9635	12090	14560	15795	17020	18255	19490	20710	21945	23180	24415	25640	26875
6 mph Cyc			6285	8155	10030	10970	11905	12840	13780	14715	15655	16590	17525		
15 mph	4245	5015	5775	6810	7860	8380	8895	9415	9930	10430	10935	11430	11925		
20 mph	4180	4870	5565	6560	7550	8035	8530	9030	9525	10020	10515	11000	11495		
25 mph	4000	4610	5205	6130	7055	7520	7980	8435	8895	9360	9820	10285	10750		
30 mph		4610	5205	6130	7055	7520	7980	8435	8895	9360	9820	10285	10750		
40 mph		3715	4485	5300	6120	6525	6935	7330	7740	8145	8555	8960	9370		

* Refer to the notes at the end of the tables of this range

CROSSGRIP®

Tire specifications and pressure table. Load per tire in lbs.*

Rim Size (inch)		Description										MSPN (CAI)			
34		440/80 R34 159A8/155D IND TL 16.9R34										41135 (967528)			
Section Width	Overall Diam. (in.)	Loaded Radius (in.)	Rolling Circum. (in.)	Recommended Rim	Acceptable Rims					Min. Dual Spacing (in.)	75% internal volume (gal.)	Tread depth (32nd in.)			
17	62	28.3	185.3	DW14L	DW15L DW16L						78	35			
Psi	12	17	23	29	35	38	41	44	46	49	52	55	58	61	64
6 mph Cyc			7210	8695	10175	10890	11605	12325	13040	13755	14475				
15 mph	4640	5335	6020	7045	8060	8610	9150	9690	10230						
20 mph	4565	5235	5910	6910	7915	8445	8975	9500	10030						
25 mph	4375	5025	5675	6645	7605	8125	8630	9140	9645						
30 mph		5025	5675	6645	7605	8115	8620	9140	9645						
40 mph		4070	4970	5840	6715	7175	7630	8090	8545						

Rim Size (inch)		Description										MSPN (CAI)			
34		480/80 R34 164A8/159D IND TL 18.4R34										56587 (333253)			
Section Width	Overall Diam. (in.)	Loaded Radius (in.)	Rolling Circum. (in.)	Recommended Rim	Acceptable Rims					Min. Dual Spacing (in.)	75% internal volume (gal.)	Tread depth (32nd in.)			
19	65	29.3	192.9	DW15L	DW16L DW18L						95.5	35			
Psi	12	17	23	29	35	38	41	44	46	49	52	55	58	61	64
6 mph Cyc			8035	9890	11740	12545	13340	14145	14935	15740	16535				
15 mph	5300	6040	6780	8070	9350	9930	10515	11100	11685						
20 mph	5225	5940	6645	7915	9170	9745	10320	10890	11465						
25 mph	5005	5700	6395	7605	8820	9370	9920	10470	11025						
30 mph		5700	6395	7605	8820	9370	9920	10470	11025						
40 mph		4640	5600	6660	7715	8200	8685	9160	9645						

Rim Size (inch)		Description										MSPN (CAI)			
38		480/80 R38 166A8/161D IND TL 18.4R38										06819 (846732)			
Section Width	Overall Diam. (in.)	Loaded Radius (in.)	Rolling Circum. (in.)	Recommended Rim	Acceptable Rims					Min. Dual Spacing (in.)	75% internal volume (gal.)	Tread depth (32nd in.)			
19	69	31.1	208.4	DW15L	DW16L DW18L					24.6	109.9	37			
Psi	12	17	23	29	35	38	41	44	46	49	52	55	58	61	64
Static			13060	16040	19015	20325	21640	22950	24250	25565	26875				
6 mph Cyc			8520	10460	12400	13260	14110	14970	15820	16680	17525				
15 mph	5590	6395	7185	8565	9930	10550	11165	11775	12390						
20 mph	5500	6285	7055	8400	9745	10350	10945	11550	12145						
25 mph	5270	6030	6780	8005	9235	9845	10460	11065	11685						
30 mph		6030	6780	8005	9235	9845	10460	11065	11685						
40 mph		4895	5930	7000	8070	8600	9125	9665	10195						

* Refer to the notes at the end of the tables of this range

Tire specifications and pressure table. Load per tire in lbs.*

Rim Size (inch)		Description										MSPN (CAI)			
38		540/80 R38 172A8/167D IND TL										65312 (567367)			
Section Width	Overall Diam. (in.)	Loaded Radius (in.)	Rolling Circum. (in.)	Recommended Rim	Acceptable Rims					Min. Dual Spacing (in.)	75% internal volume (gal.)	Tread depth (32nd in.)			
22	73	32.8	217	DW18L	DW16L					27.5	138.3	35			
Psi	12	17	23	29	35	38	41	44	46	49	52	55	58	61	64
Static			22805	24735	26655	27975	29300	30620	31945	33885	35825				
6 mph Cyc			14915	16180	17440	18275	19115	19950	20790	22110	23435				
15 mph	6690	8610	10515	11410	12290	12885	13480	14065	14660						
20 mph	6580	8465	10350	11220	12090	12675	13260	13835	14420						
25 mph	6305	8115	9920	10915	11905	12400	12895	13395	13890						
30 mph		7615	9315	10230	11145	11605	12060	12520	12975						
40 mph		7055	8620	9470	10320	10750	11165	11595	12015						

***IMPORTANT:**

The inflation pressure must always be appropriate for the load per tire, the speed of travel and the work to be done. Our recommendations above are provided subject to changes made after the date of publication of these tables. Technical data is subject to change without prior notice.

- When using single tire configuration:
 - add 6 psi for use on slopes of more than 20%
 - add 6 psi for intense road use exceeding 50%
- Stat: static load.
- 6 mph Cyc: max. speed 6 mph with cyclic load.



XF™

RADIAL STEEL CONSTRUCTION TO INCREASE TIRE LIFE & TRACTION



Wheeled Excavators



RADIAL TIRE



COMFORT

- Protection of vehicle & operator



SERVICE LIFE

- Proven casing endurance



VERSATILITY

- Efficient on all surfaces



100% STEEL CONSTRUCTION

- Great stability
- Excellent puncture resistance and better load distribution



* vs. main competitor bias tire

SIZES

445/70 R19.5 173A8/180A2 TL

445/70 R22.5 175A8/182A2 TL

Tire specifications and pressure table. Load per tire in lbs.*

Rim Size (inch)		Description										MSPN (CAI)			
19.5		445/70 R19.5 173A8/180A2 TL 18 R19.5										81617 (489102)			
Section Width	Overall Diam. (in.)	Loaded Radius (in.)	Rolling Circum. (in.)	Recommended Rim	Acceptable Rims						Min. Dual Spacing (in.)	75% internal volume (gal.)	Tread depth (32nd in.)		
18	44	19.6	131.1	14.00							23	43.6	23		
Psi	51	55	58	64	70	75	81	87	90	93	96	99	102	104	109
Stat	14505	15565	16280	17690	19105	20525	21935	23360	24065	24770	25475	26180	26895	27600	28660
6 mph	8930	9580	10020	10890	11760	12630	13505	14375	14805	15245	15675	16115	16545	16985	17635
12 mph	7905	8490	8875	9645	10415	11190	11960	12730	13120	13505	13890	14275	14660	15045	15620
20 mph	7540	8090	8465	9195	9930	10670	11410	12145	12510	12875	13250	13615	13990	14350	14905
22 mph	7395	7935	8300	9015	9745	10460	11190	11905	12270	12630	12995	13350	13715	14075	14615
25 mph	7255	7780	8135	8840	9555	10265	10970	11675	12025	12380	12745	13095	13450	13800	14330

Rim Size (inch)		Description										MSPN (CAI)			
22.5		445/70 R22.5 175A8/182A2 TL 18 R22.5										33819 (073522)			
Section Width	Overall Diam. (in.)	Loaded Radius (in.)	Rolling Circum. (in.)	Recommended Rim	Acceptable Rims						Min. Dual Spacing (in.)	75% internal volume (gal.)	Tread depth (32nd in.)		
18	47	21.2	141	14.00							23	50.5	25		
Psi	51	55	58	64	70	75	81	87	90	93	96	99	102	104	109
Stat	15390	16515	17275	18770	20270	21780	23280	24790	25540	26290	27040	27790	28550	29300	30425
6 mph	9480	10175	10635	11565	12490	13415	14340	15265	15730	16195	16655	17120	17580	18045	18740
12 mph	8390	9005	9415	10230	11045	11870	12690	13505	13920	14330	14740	15145	15555	15960	16580
20 mph	8015	8600	8995	9780	10550	11330	12115	12895	13295	13680	14065	14460	14850	15245	15830
22 mph	7850	8420	8805	9580	10340	11110	11870	12645	13030	13415	13790	14175	14560	14945	15520
25 mph	7695	8255	8630	9380	10140	10890	11640	12390	12765	13140	13525	13900	14275	14650	15210

***IMPORTANT:**

The inflation pressure must always be appropriate for the load per tire, the speed of travel and the work to be done. Our recommendations above are provided subject to changes made after the date of publication of these tables. Technical data is subject to change without prior notice.

- When using single tire configuration:
 - add 6 psi for use on slopes of more than 20%
 - add 6 psi for intense road use exceeding 50%
- Stat: static load.



XM47™

GREAT ON-ROAD COMFORT & GOOD GRIP IN OFF-ROAD CONDITIONS



Backhoe Loaders



Compact Wheel Loaders



Telehandlers



FOR MULTI PURPOSE OFF-ROAD MACHINERY

- Radial tire up to 55 mph



SPEED

- Very good handling up to 55 mph



ROBUSTNESS

- Reinforced structure



SERVICE LIFE

- Proven casing endurance



SIZES

405/70 R20 136G TL

445/70 R24 151G TL

495/70 R24 155G TL

425/75 R20 148G TL

Tire specifications and pressure table. Load per tire in lbs.*

Rim Size (inch)		Description										MSPN (CAI)			
20		405/70 R20 136G TL										97684 (123708)			
Section Width	Overall Diam. (in.)	Loaded Radius (in.)	Rolling Circum. (in.)	Recommended Rim	Acceptable Rims						Min. Dual Spacing (in.)	75% internal volume (gal.)	Tread depth (32nd in.)		
16	42	19	125.7	11	11SDC W10						21.2	36.2	35		
Psi	15	17	23	26	29	32	35	38	41	44	46	49	52	55	59
Stat	4300	4815	5855	6370	6890	7420	7935	8455	8975	9490	10010	10525	11045	11565	12345
6 mph	3085	3460	4210	4585	4960	5335	5710	6075	6450	6825	7200	7575	7950	8320	8885
20 mph	2140	2405	2920	3175	3440	3705	3955	4220	4485	4740	5005	5260	5525	5785	6175
25 mph	1985	2225	2700	2945	3175	3415	3660	3890	4135	4375	4610	4850	5095	5325	5690
40 mph	1875	2095	2545	2780	3000	3220	3450	3670	3890	4125	4345	4575	4795	5015	5355
55 mph	1720	1930	2350	2545	2755	2965	3175	3385	3595	3790	4000	4210	4420	4630	4940

Rim Size (inch)		Description										MSPN (CAI)			
20		425/75 R20 148G TL										08686 (123706)			
Section Width	Overall Diam. (in.)	Loaded Radius (in.)	Rolling Circum. (in.)	Recommended Rim	Acceptable Rims						Min. Dual Spacing (in.)	75% internal volume (gal.)	Tread depth (32nd in.)		
18	45	20	133.8	13	11 11SDC 13SDC						21.9	48.9	38		
Psi	15	17	23	26	29	32	35	38	41	44	46	49	52	55	59
Stat	6065	6790	8245	8985	9710	10440	11165	11895	12620	13350	14075	14815	15545	16270	17360
6 mph	4345	4870	5920	6450	6980	7495	8025	8555	9085	9600	10130	10660	11190	11705	12500
20 mph	3020	3385	4110	4485	4850	5215	5580	5940	6305	6680	7045	7410	7770	8135	8685
25 mph	2780	3110	3780	4125	4455	4795	5125	5465	5800	6140	6470	6800	7145	7475	7980
40 mph	2625	2945	3570	3890	4210	4530	4840	5160	5480	5800	6120	6425	6745	7065	7540
55 mph	2425	2710	3295	3595	3880	4180	4465	4760	5050	5345	5635	5920	6215	6505	6945

Rim Size (inch)		Description										MSPN (CAI)			
24		445/70 R24 151G TL										13804 (123642)			
Section Width	Overall Diam. (in.)	Loaded Radius (in.)	Rolling Circum. (in.)	Recommended Rim	Acceptable Rims						Min. Dual Spacing (in.)	75% internal volume (gal.)	Tread depth (32nd in.)		
18	49	22.1	145.2	DW15L	DW14L W14L W15L						23	55.5	43		
Psi	15	17	23	26	29	32	35	38	41	44	46	49	52	55	59
Stat	6615	7420	9015	9810	10615	11410	12215	13020	13810	14615	15410	16215	17020	17815	19015
6 mph	4760	5335	6495	7065	7640	8225	8795	9370	9945	10525	11100	11675	12245	12830	13690
20 mph	3305	3705	4510	4905	5300	5710	6105	6505	6900	7310	7705	8100	8500	8905	9500
25 mph	3040	3405	4145	4520	4885	5260	5620	5985	6360	6725	7100	7465	7825	8200	8750
40 mph	2865	3210	3900	4255	4595	4950	5290	5645	5985	6340	6680	7035	7375	7725	8245
55 mph	2645	2965	3605	3925	4245	4565	4885	5205	5525	5840	6160	6480	6800	7120	7605

* Refer to the notes at the end of the tables of this range

XM47™

Tire specifications and pressure table. Load per tire in lbs.*

Rim Size (inch)		Description										MSPN (CAI)			
24		495/70 R24 155G TL										88892 (123620)			
Section Width	Overall Diam. (in.)	Loaded Radius (in.)	Rolling Circum. (in.)	Recommended Rim	Acceptable Rims						Min. Dual Spacing (in.)	75% internal volume (gal.)	Tread depth (32nd in.)		
20	51	22.9	152.9	DW16L	W16L						25.6	65.4	44		
Psi	15	17	23	26	29	32	35	38	41	44	46	49	52	55	59
Stat	7440	8345	10140	11035	11940	12840	13735	14640	15545	16435	17340	18230	19135	20040	21385
6 mph	5355	6010	7295	7950	8600	9235	9890	10540	11175	11830	12480	13130	13770	14420	15390
20 mph	3725	4180	5070	5525	5965	6415	6865	7310	7760	8200	8655	9105	9545	10000	10670
25 mph	3415	3835	4665	5070	5490	5895	6315	6725	7145	7550	7970	8390	8795	9215	9835
40 mph	3220	3605	4385	4775	5170	5555	5940	6340	6725	7120	7505	7895	8290	8675	9260
55 mph	2975	3340	4055	4420	4775	5135	5500	5855	6215	6570	6935	7295	7650	8015	8555

***IMPORTANT:**

The inflation pressure must always be appropriate for the load per tire, the speed of travel and the work to be done. Our recommendations above are provided subject to changes made after the date of publication of these tables. Technical data is subject to change without prior notice.

- When using single tire configuration:
 - add 6 psi for use on slopes of more than 20%
 - add 6 psi for intense road use exceeding 50%
- Stat: static load.



POWER CL™

*BIAS PLY TIRE RESISTANT TO CUTS
WITH GREAT STABILITY*



Backhoe Loaders



Compact Wheel Loaders



Telehandlers



ROBUSTNESS

- Multiple casing plies for impact and puncture resistance



STABILITY

- Sidewall rigidity allows for excellent vertical and lateral stability



LOAD CAPACITY

- High load capacity for optimized productivity



SIDEWALL THICKNESS

- 20 mm compared to 12 mm (vs. a leading competitor tire)
- Enhanced puncture resistance



SIZES

280/80 -18 132A8 IND TL	400/70 -20 149A8 IND TL	500/70 -24 164A8 IND TL
340/80 -18 143A8 IND TL	400/70 -24 158A8 IND TL	440/80 -24 168A8 IND TL
280/80 -20 133A8 IND TL	460/70 -24 159A8 IND TL	480/80 -26 167A8 IND TL
340/80 -20 144A8 IND TL	400/80 -24 162A8 IND TL	440/80 -28 163 A8 IND TL

POWER CL™

Tire specifications and pressure table. Load per tire in lbs.*

Rim Size (inch)		Description									MSPN (CAI)				
18		280/80 -18 132A8 IND TL 10.5/80 - 18 (Equiv 10PR)									38882 (281778)				
Section Width	Overall Diam. (in.)	Loaded Radius (in.)	Rolling Circum. (in.)	Recommended Rim	Acceptable Rims					Min. Dual Spacing (in.)	75% internal volume (gal.)	Tread depth (32nd in.)			
11	35	16.3	105.9	9	10 W10 W8 W9					13.7	21.2	33			
Psi	15	17	23	29	35	41	46	52	55	58	61	64	67	70	73
Stat	4055	4465	5270	6085	6900	7705	8520	9325	9735	10140					
6 mph Cyc	2645	2910	3440	3970	4495	5025	5555	6085	6350	6615					
6 mph	2205	2425	2865	3305	3750	4190	4630	5070	5290	5510					
15 mph	1875	2060	2435	2810	3185	3550	3925	4300	4485	4675					
20 mph	1830	2015	2380	2745	3120	3485	3845	4220	4400	4585					
25 mph	1765	1940	2295	2645	3000	3350	3705	4055	4235	4410					

Rim Size (inch)		Description									MSPN (CAI)				
18		340/80 -18 143A8 IND TL 12.5/80 - 18 (Equiv 12PR)									04967 (610873)				
Section Width	Overall Diam. (in.)	Loaded Radius (in.)	Rolling Circum. (in.)	Recommended Rim	Acceptable Rims					Min. Dual Spacing (in.)	75% internal volume (gal.)	Tread depth (32nd in.)			
14	39	17.8	117.6	11	10 11SDC 12 12SDC W10 W11					16.3	27.9	30			
Psi	15	17	23	29	35	41	46	52	55	58	61	64	67	70	73
Stat	5535	6085	7185	8300	9405	10505	11605	12720	13270	13825					
6 mph Cyc	3615	3980	4695	5410	6140	6855	7575	8300	8655	9015					
6 mph	3000	3295	3900	4510	5105	5710	6315	6910	7220	7520					
15 mph	2545	2800	3320	3825	4330	4850	5355	5875	6130	6380					
20 mph	2490	2745	3240	3735	4245	4740	5235	5745	5985	6240					
25 mph	2405	2645	3130	3605	4090	4575	5060	5535	5775	6020					

Rim Size (inch)		Description									MSPN (CAI)				
20		280/80 -20 133A8 IND TL 10.5/80 - 20 (Equiv 10PR)									28486 (694767)				
Section Width	Overall Diam. (in.)	Loaded Radius (in.)	Rolling Circum. (in.)	Recommended Rim	Acceptable Rims					Min. Dual Spacing (in.)	75% internal volume (gal.)	Tread depth (32nd in.)			
11	37	17.1	111.3	9	10 W10 W8 W9					13.7	22.8	34			
Psi	15	17	23	29	35	41	46	52	55	58	61	64	67	70	73
Stat	4190	4610	5445	6270	7110	7950	8785	9610	10030	10450					
6 mph Cyc	2735	3010	3550	4090	4640	5180	5720	6270	6535	6810					
6 mph	2270	2500	2955	3405	3870	4320	4775	5235	5455	5690					
15 mph	1920	2115	2500	2890	3275	3660	4045	4430	4620	4815					
20 mph	1895	2085	2460	2835	3210	3595	3970	4345	4530	4720					
25 mph	1810	1995	2360	2725	3085	3450	3815	4180	4355	4540					

Rim Size (inch)		Description									MSPN (CAI)				
20		340/80 -20 144A8 IND TL 12.5/80 - 20 (Equiv 12PR)									56730 (495503)				
Section Width	Overall Diam. (in.)	Loaded Radius (in.)	Rolling Circum. (in.)	Recommended Rim	Acceptable Rims					Min. Dual Spacing (in.)	75% internal volume (gal.)	Tread depth (32nd in.)			
13	41	18.7	122.5	11	10 11SDC 12 12SDC W10 W11					16.3	29.9	31			
Psi	15	17	23	29	35	41	46	52	55	58	61	64	67	70	73
Stat	5690	6250	7385	8520	9655	10790	11925	13060	13635	14200					
6 mph Cyc	3705	4080	4815	5555	6295	7035	7780	8520	8885	9260					
6 mph	3085	3395	4010	4630	5245	5865	6480	7100	7410	7715					
15 mph	2610	2875	3395	3925	4455	4970	5500	6020	6285	6550					
20 mph	2555	2810	3330	3845	4355	4870	5390	5895	6160	6415					
25 mph	2470	2710	3210	3705	4200	4695	5180	5675	5930	6175					

* Refer to the notes at the end of the tables of this range



POWER CL™

Tire specifications and pressure table. Load per tire in lbs.*

Rim Size (inch)		Description									MSPN (CAI)				
20		400/70 -20 149A8 IND TL 16.0/70 - 20 / 405/70 - 20 (Equiv 16PR)									18007 (346809)				
Section Width	Overall Diam. (in.)	Loaded Radius (in.)	Rolling Circum. (in.)	Recommended Rim	Acceptable Rims					Min. Dual Spacing (in.)	75% internal volume (gal.)	Tread depth (32nd in.)			
16	42	18.9	124.7	13	12 12SDC 13SDC 14					19	34.1	37			
Psi	15	17	23	29	35	41	46	52	55	58	61	64	67	70	73
Stat	6590	7255	8575	9890	11210	12535	13855	15170	15830	16490					
6 mph Cyc	4300	4730	5590	6450	7310	8180	9040	9900	10330	10760					
6 mph	3595	3945	4665	5380	6095	6810	7520	8235	8600	8950					
15 mph	3040	3350	3955	4565	5170	5775	6380	6990	7285	7595					
20 mph	2975	3275	3870	4465	5060	5665	6260	6855	7155	7450					
25 mph	2865	3155	3725	4300	4870	5445	6020	6590	6880	7165					

Rim Size (inch)		Description									MSPN (CAI)				
24		400/70 -24 158A8 IND TL 16.0/70 - 24 / 405/70 - 24 (Equiv 20PR)									60752 (407878)				
Section Width	Overall Diam. (in.)	Loaded Radius (in.)	Rolling Circum. (in.)	Recommended Rim	Acceptable Rims					Min. Dual Spacing (in.)	75% internal volume (gal.)	Tread depth (32nd in.)			
16	46	21.1	137.7	DW13	13 14 DW14L					19	43.6	37			
Psi	15	17	23	29	35	41	46	52	55	58	61	64	67	70	73
Stat	7255	7970	9405	10825	12260	13690	15115	16545	17260	17980	18695	19400	20115	20835	21550
6 mph Cyc	4730	5190	6130	7065	7990	8930	9855	10790	11255	11730	12190	12655	13120	13590	14055
6 mph	3945	4330	5115	5885	6670	7440	8225	8995	9390	9780	10165	10550	10945	11330	11720
15 mph	3340	3670	4330	4995	5645	6305	6965	7630	7960	8290	8610	8940	9270	9600	9930
20 mph	3275	3595	4245	4895	5535	6185	6835	7485	7805	8125	8455	8775	9095	9425	9745
25 mph	3155	3460	4090	4705	5325	5950	6570	7200	7505	7815	8125	8435	8750	9060	9370

Rim Size (inch)		Description									MSPN (CAI)				
24		400/80 -24 162A8 IND TL 15.5/80 -24 Equiv 20 PR)									53837 (050267)				
Section Width	Overall Diam. (in.)	Loaded Radius (in.)	Rolling Circum. (in.)	Recommended Rim	Acceptable Rims					Min. Dual Spacing (in.)	75% internal volume (gal.)	Tread depth (32nd in.)			
16	49	22.5	147.4	DW13	13 14 DW14L					19	49.3	37			
Psi	15	17	23	29	35	41	46	52	55	58	61	64	67	70	73
Stat	8115	8920	10515	12115	13715	15310	16910	18510	19300	20105	20900	21705	22500	23305	24095
6 mph Cyc	5290	5810	6855	7905	8940	9985	11025	12070	12590	13120	13635	14155	14670	15200	15720
6 mph Dual	3305	3585	4135	4685	5235	5785	6340	6890	7165	7440	7715	7990	8265	8545	8820
6 mph	4410	4840	5710	6580	7450	8320	9180	10055	10495	10925	11355	11795	12225	12665	13095
15 mph	3735	4100	4840	5580	6315	7055	7780	8520	8895	9260	9625	10000	10360	10735	11100
20 mph	3660	4025	4740	5465	6195	6910	7640	8355	8720	9085	9445	9810	10165	10525	10890
25 mph	3525	3880	4575	5270	5965	6660	7350	8045	8390	8740	9085	9435	9780	10130	10470
20 mph FRT	6615	6725	6945	7165	7385	7605	7825	8045	8155	8265	8380	8490	8600	8710	8820

* Refer to the notes at the end of the tables of this range

POWER CL™

Tire specifications and pressure table. Load per tire in lbs.*

Rim Size (inch)		Description										MSPN (CAI)			
24		440/80 -24 168A8 IND TL 16.9 - 24 / 16.5/85 - 24 (Equiv 22PR)										56443 (165629)			
Section Width	Overall Diam. (in.)	Loaded Radius (in.)	Rolling Circum. (in.)	Recommended Rim	Acceptable Rims					Min. Dual Spacing (in.)	75% internal volume (gal.)	Tread depth (32nd in.)			
18	52	23.5	155.3	DW15L	14 DW13 DW14L					20.6	62.2	37			
Psi	15	17	23	29	35	41	46	52	55	58	61	64	67	70	73
Stat	9570	10505	12390	14275	16160	18045	19920	21805	22750	23690	24625	25575	26510	27460	28395
6 mph Cyc	6240	6855	8080	9315	10540	11760	12995	14220	14835	15455	16060	16680	17295	17900	18520
6 mph	5205	5710	6735	7760	8785	9810	10825	11850	12370	12875	13380	13900	14405	14925	15430
15 mph	4420	4850	5720	6590	7450	8320	9180	10055	10485	10925	11355	11785	12215	12655	13085
20 mph	4320	4750	5600	6450	7295	8145	9005	9855	10275	10705	11135	11550	11980	12400	12830
25 mph	4165	4575	5390	6215	7035	7850	8665	9480	9890	10305	10715	11120	11530	11940	12345

Rim Size (inch)		Description										MSPN (CAI)			
24		460/70 -24 159A8 IND TL 17.5 L - 24 (Equiv 18PR)										86617 (474764)			
Section Width	Overall Diam. (in.)	Loaded Radius (in.)	Rolling Circum. (in.)	Recommended Rim	Acceptable Rims					Min. Dual Spacing (in.)	75% internal volume (gal.)	Tread depth (32nd in.)			
18	49	22	145.2	DW15L	14 16 DW14L DW16L					21.2	57.2	37			
Psi	15	17	23	29	35	41	46	52	55	58	61	64	67	70	73
Stat	7605	8575	10515	12465	14405	16345	18285	20240	21210	22180					
6 mph Cyc	4960	5590	6855	8125	9390	10660	11925	13195	13835	14460					
6 mph	4135	4665	5720	6780	7835	8885	9945	11000	11530	12060					
15 mph	3505	3955	4850	5745	6645	7540	8435	9335	9780	10230					
20 mph	3440	3880	4760	5635	6515	7395	8280	9150	9590	10030					
25 mph	3305	3725	4575	5425	6260	7110	7960	8795	9225	9645					

Rim Size (inch)		Description										MSPN (CAI)			
24		500/70 -24 164A8 IND TL 19.5 L - 24 (Equiv 20PR)										06567 (196220)			
Section Width	Overall Diam. (in.)	Loaded Radius (in.)	Rolling Circum. (in.)	Recommended Rim	Acceptable Rims					Min. Dual Spacing (in.)	75% internal volume (gal.)	Tread depth (32nd in.)			
20	52	23.1	153.7	DW16L	16 DW15L					23.3	69.7	37			
Psi	15	17	23	29	35	41	46	52	55	58	61	64	67	70	73
Stat	8620	9735	11970	14200	16425	18660	20890	23125	24240	25355					
6 mph Cyc	5620	6350	7805	9260	10715	12170	13625	15080	15805	16535					
6 mph	4685	5290	6505	7715	8930	10140	11355	12565	13175	13780					
15 mph	3970	4485	5510	6535	7575	8600	9625	10660	11165	11685					
20 mph	3900	4410	5410	6425	7430	8445	9445	10460	10955	11465					
25 mph	3750	4235	5205	6175	7145	8115	9085	10055	10540	11025					

Rim Size (inch)		Description										MSPN (CAI)			
26		480/80 -26 167A8 IND TL 18.4 - 26 (Equiv 20PR)										32114 (226486)			
Section Width	Overall Diam. (in.)	Loaded Radius (in.)	Rolling Circum. (in.)	Recommended Rim	Acceptable Rims					Min. Dual Spacing (in.)	75% internal volume (gal.)	Tread depth (32nd in.)			
20	56	25.1	165.8	DW16L	DW15L					22.2	79.8	35			
Psi	15	17	23	29	35	41	46	52	55	58	61	64	67	70	73
Stat	10845	11940	14110	16290	18465	20645	22820	25230	26435	27635					
6 mph Cyc	7075	7780	9205	10625	12050	13460	14880	16460	17240	18025					
6 mph	5885	6480	7660	8850	10040	11220	12410	13725	14375	15025					
15 mph	5005	5500	6505	7505	8510	9515	10515	11630	12190	12745					
20 mph	4895	5390	6370	7365	8345	9335	10320	11410	11960	12500					
25 mph	4720	5190	6140	7090	8025	8975	9920	10970	11495	12015					

* Refer to the notes at the end of the tables of this range

POWER CL™

Tire specifications and pressure table. Load per tire in lbs.*

Rim Size (inch)		Description									MSPN (CAI)				
28		440/80 -28 163 A8 IND TL 16.9 - 28 / 16.5/85 - 28 (Equiv 18PR)									95541 (691578)				
Section Width	Overall Diam. (in.)	Loaded Radius (in.)	Rolling Circum. (in.)	Recommended Rim	Acceptable Rims					Min. Dual Spacing (in.)	75% internal volume (gal.)	Tread depth (32nd in.)			
18	55	25.3	165.4	DW15L	DW13 DW14L					20.6	68.3	37			
Psi	15	17	23	29	35	41	46	52	55	58	61	64	67	70	73
Stat	9635	10605	12535	14475	16415	18340	20285	22510	23610	24725					
6 mph Cyc	6285	6910	8180	9435	10705	11960	13230	14685	15400	16125					
6 mph	5235	5765	6810	7870	8920	9975	11025	12235	12830	13435					
15 mph	4440	4885	5775	6670	7560	8455	9350	10375	10890	11400					
20 mph	4355	4795	5665	6550	7420	8300	9170	10175	10680	11175					
25 mph	4190	4610	5455	6295	7130	7980	8820	9790	10265	10750					

***IMPORTANT:**

The inflation pressure must always be appropriate for the load per tire, the speed of travel and the work to be done. Our recommendations above are provided subject to changes made after the date of publication of these tables. Technical data is subject to change without prior notice.

- When using single tire configuration:
 - add 6 psi for use on slopes of more than 20%
 - add 6 psi for intense road use exceeding 50%
- Stat: static load.
- 6 mph Cyc: max. speed 6 mph with cyclic load.



POWER DIGGER

BIAS PLY TIRE RESISTANT TO CUTS WITH GREAT STABILITY

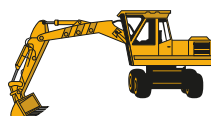

Wheeled Excavators



LONG SERVICE LIFE

- Excellent wear resistance for long service life



DAMAGE & CUT RESISTANT

- +57% sidewall thickness¹



STABILITY

- High bridging in tread blocks help with handling and wear



ROBUSTNESS

- Rugged design for damage resistance

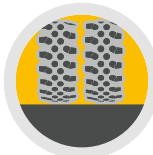

DUAL FITMENT FOR WHEELED EXCAVATORS²



(1) Compared to main competitor bias tire
 (2) Requires tube and a flap

SIZES

10.00-20 165A2/147B 16PR TT

POWER DIGGER

Tire specifications and pressure table. Load per tire in lbs.*

Rim Size (inch)		Description								MSPN (CAI)					
20		10.00-20 165A2/147B 16PR TT [DISCONTINUED]								03227 (263208)					
Section Width	Overall Diam. (in.)	Loaded Radius (in.)	Rolling Circum. (in.)	Recommended Rim		Acceptable Rims				Min. Dual Spacing (in.)	75% internal volume (gal.)	Tread depth (32nd in.)			
11	41	19.2	123.8	7.5T						13.4	13.9	19			
Psi	58	64	70	75	81	87	93	96	99	102	104	107	110	113	116
Stat	8820	9655	10495	11330	12170	13005	13800	14200	14595	14990	15390	15785	16180	16570	16955
6 mph	5885	6450	7010	7560	8125	8685	9215	9480	9755	10020	10285	10550	10815	11090	11355
12 mph	4695	5135	5590	6030	6480	6925	7340	7550	7760	7970	8180	8390	8600	8805	9015
20 mph	3845	4210	4575	4940	5300	5665	6010	6185	6360	6535	6700	6880	7055	7240	7430
22 mph	3595	3935	4275	4620	4960	5300	5635	5785	5950	6120	6285	6450	6605	6755	6910
30 mph	3000	3440	3880	4320	4760	5205	5525	5675	5840	5995	6150	6315	6470	6625	6780

***IMPORTANT:**

The inflation pressure must always be appropriate for the load per tire, the speed of travel and the work to be done. Our recommendations above are provided subject to changes made after the date of publication of these tables. Technical data is subject to change without prior notice.

- When using single tire configuration:
 - add 6 psi for use on slopes of more than 20%
 - add 6 psi for intense road use exceeding 50%
- Stat: static load.



BIBSTEEL™ ALL TERRAIN

REINFORCED RADIAL CONSTRUCTION /
BETTER TRACTION / NO DOWNTIME



Skid Steer Loaders



Telehandlers



Backhoe Loaders



COMFORT

- Smooth ride for vehicle & operator



TRACTION

- Radial construction & open tread pattern



ROBUSTNESS

- 100% steel construction for puncture resistance



SERVICE LIFE

- Proven casing endurance



100% STEEL CONSTRUCTION

- Great stability
- Excellent puncture resistance and better load distribution



SIZES

210/70 R15 117A8/117B IND TL

300/70 R16.5 137A8/137B IND TL

360/70 R17.5 148A8/148B IND TL

260/70 R16.5 129A8/129B IND TL

BIBSTEEL™ ALL TERRAIN

Tire specifications and pressure table. Load per tire in lbs.*

Rim Size (inch)		Description										MSPN (CAI)			
15		210/70 R15 117A8/117B IND TL (27 x 8.50 R15) Equiv 8PR Replaces size 215/70 R15										20011 (085459)			
Section Width	Overall Diam. (in.)	Loaded Radius (in.)	Rolling Circum. (in.)	Recommended Rim	Acceptable Rims					Min. Dual Spacing (in.)	75% internal volume (gal.)	Tread depth (32nd in.)			
8	27	12.4	80	7.00						12.1	6.9	19			
Psi	22	26	32	38	44	46	49	52	55	58	61	64	67	70	73
Stat	2425	2800	3275	3735	4200	4430	4665	4895	5125	5355	5590	5820	6050	6285	6515
15 mph	1170	1355	1585	1810	2030	2140	2250	2360	2480	2590	2700	2810	2930	3040	3155
25 mph	1045	1215	1420	1630	1830	1930	2030	2125	2225	2325	2435	2535	2635	2735	2835
30 mph	1045	1215	1420	1630	1830	1930	2030	2125	2225	2325	2435	2535	2635	2735	2835

Rim Size (inch)		Description										MSPN (CAI)			
16.5		260/70 R16.5 129A8/129B IND TL (10 R16.5) Equiv 12PR Replaces size 265/70 R16.5										19038 (176281)			
Section Width	Overall Diam. (in.)	Loaded Radius (in.)	Rolling Circum. (in.)	Recommended Rim	Acceptable Rims					Min. Dual Spacing (in.)	75% internal volume (gal.)	Tread depth (32nd in.)			
10	30	14	90.9	8.25						14.2	12.3	25			
Psi	22	26	32	38	44	46	49	52	55	58	61	64	67	70	73
Stat	3505	3990	4650	5325	5995	6325	6670	7010	7340	7685	8025	8365	8695	9040	9380
15 mph	1675	1920	2240	2570	2900	3065	3230	3395	3550	3715	3880	4045	4200	4365	4530
25 mph	1520	1730	2015	2315	2610	2755	2900	3055	3195	3340	3495	3640	3780	3935	4080
30 mph	1520	1730	2015	2315	2610	2755	2900	3055	3195	3340	3495	3640	3780	3935	4080

Rim Size (inch)		Description										MSPN (CAI)			
16.5		300/70 R16.5 137A8/137B IND TL (12 R16.5) Equiv 14PR										34034 (625787)			
Section Width	Overall Diam. (in.)	Loaded Radius (in.)	Rolling Circum. (in.)	Recommended Rim	Acceptable Rims					Min. Dual Spacing (in.)	75% internal volume (gal.)	Tread depth (32nd in.)			
12	33	15	97.7	9.75						16.3	17	29			
Psi	22	26	32	38	44	46	49	52	55	58	61	64	67	70	73
Stat	4430	5005	5800	6625	7450	7860	8280	8710	9125	9545	9975	10395	10815	11245	11660
15 mph	2140	2415	2800	3195	3595	3790	3990	4200	4400	4610	4805	5015	5215	5425	5620
25 mph	1930	2170	2515	2875	3240	3415	3605	3780	3970	4155	4330	4520	4705	4885	5070
30 mph	1930	2170	2515	2875	3240	3415	3605	3780	3970	4155	4330	4520	4705	4885	5070

Rim Size (inch)		Description										MSPN (CAI)			
17.5		360/70 R17.5 148A8/148B IND TL										17395 (360353)			
Section Width	Overall Diam. (in.)	Loaded Radius (in.)	Rolling Circum. (in.)	Recommended Rim	Acceptable Rims					Min. Dual Spacing (in.)	75% internal volume (gal.)	Tread depth (32nd in.)			
14	37	16.9	111.1	10.5						18.6	26.1	33			
Psi	22	26	32	38	44	46	49	52	55	58	61	64	67	70	73
Stat	5985	6845	7980	9125	10275	10845	11410	11980	12555	13130	13700	14275	14835	15410	15985
15 mph	2865	3285	3835	4385	4950	5225	5500	5775	6050	6325	6605	6890	7165	7440	7715
25 mph	2600	2975	3470	3970	4465	4705	4960	5205	5455	5700	5950	6195	6450	6690	6945
30 mph	2600	2975	3470	3970	4465	4705	4960	5205	5455	5700	5950	6195	6450	6690	6945

***IMPORTANT:**

The inflation pressure must always be appropriate for the load per tire, the speed of travel and the work to be done. Our recommendations above are provided subject to changes made after the date of publication of these tables. Technical data is subject to change without prior notice.

- When using single tire configuration:
 - add 6 psi for use on slopes of more than 20%
 - add 6 psi for intense road use exceeding 50%
- Stat: static load.





BIBSTEEL™ HARD SURFACE

REINFORCED RADIAL CONSTRUCTION /
BETTER TRACTION / NO DOWNTIME



Skid Steer Loaders



Telehandlers



Backhoe Loaders



RADIAL TIRE

- Ideal for hard surface applications



COMFORT

- Smooth ride for vehicle & operator



ROBUSTNESS

- 100% steel construction for puncture resistance



SERVICE LIFE

- Proven casing endurance



100% STEEL CONSTRUCTION

- Great stability
- Excellent puncture resistance and better load distribution



SIZES

260/70 R16.5 129A8/129B IND TL

300/70 R16.5 137A8/137B IND TL

BIBSTEEL™ HARD SURFACE

Tire specifications and pressure table. Load per tire in lbs.*

Rim Size (inch)		Description										MSPN (CAI)			
16.5		260/70 R16.5 129A8/129B IND TL (10 R16.5) Equiv 12PR										38281 (275538)			
Section Width	Overall Diam. (in.)	Loaded Radius (in.)	Rolling Circum. (in.)	Recommended Rim		Acceptable Rims					Min. Dual Spacing (in.)	75% internal volume (gal.)	Tread depth (32nd in.)		
10	30	14	90.8	8.25							14.2	11.9	23		
Psi	22	26	32	38	44	46	49	52	55	58	61	64	67	70	73
Stat	3505	3990	4650	5325	5995	6325	6670	7010	7340	7685	8025	8365	8695	9040	9380
15 mph	1675	1920	2240	2570	2900	3065	3230	3395	3550	3715	3880	4045	4200	4365	4530
25 mph	1520	1730	2015	2315	2610	2755	2900	3055	3195	3340	3495	3640	3780	3935	4080
30 mph	1520	1730	2015	2315	2610	2755	2900	3055	3195	3340	3495	3640	3780	3935	4080

Rim Size (inch)		Description										MSPN (CAI)			
16.5		300/70 R16.5 137A8/137B IND TL (12 R16.5) Equiv 14PR										84590 (241265)			
Section Width	Overall Diam. (in.)	Loaded Radius (in.)	Rolling Circum. (in.)	Recommended Rim		Acceptable Rims					Min. Dual Spacing (in.)	75% internal volume (gal.)	Tread depth (32nd in.)		
12	33	14.9	97.5	9.75							16.3	17	26		
Psi	22	26	32	38	44	46	49	52	55	58	61	64	67	70	73
Stat	4430	5005	5800	6625	7450	7860	8280	8710	9125	9545	9975	10395	10815	11245	11660
15 mph	2140	2415	2800	3195	3595	3790	3990	4200	4400	4610	4805	5015	5215	5425	5620
25 mph	1930	2170	2515	2875	3240	3415	3605	3780	3970	4155	4330	4520	4705	4885	5070
30 mph	1930	2170	2515	2875	3240	3415	3605	3780	3970	4155	4330	4520	4705	4885	5070

***IMPORTANT:**

The inflation pressure must always be appropriate for the load per tire, the speed of travel and the work to be done. Our recommendations above are provided subject to changes made after the date of publication of these tables. Technical data is subject to change without prior notice.

- When using single tire configuration:
 - add 6 psi for use on slopes of more than 20%
 - add 6 psi for intense road use exceeding 50%
- Stat: static load.



X[®] TWEEL[®] SSL 2

AIRLESS RADIAL TIRE FOR SKID STEERS AND LIGHT CONSTRUCTION EQUIPMENT



Skid Steer Loaders

Tweel.Michelinman.com

The MICHELIN[®] X[®] TWEEL[®] SSL 2 airless radial tire is one single unit, replacing the current tire/wheel/valve assembly. There is no need for complex wheel/tire mounting equipment and once the TWEEL[®] unit is bolted on, there is no air pressure to maintain. TWEEL SSL 2 airless radial tires are available in two tread patterns: All Terrain and Hard Surface Traction. This second generation MICHELIN X TWEEL SSL offers significant new benefits, including:

- Improved shear beam construction engineered to maximize core life¹
- New spoke material helps provide up to 10 times greater spoke life compared to the previous models²
- New interlocked hub designed to increase durability in demanding conditions



(1) On an internal drum endurance test, the MICHELIN X TWEEL SSL 2 with a new shear beam construction lasted over twice as long as the original design.
(2) Under testing measuring crack growth under fully relaxed conditions, the new spoke material had a crack growth rate that was nearly 10 times slower than the original material.



TYPICAL CONSTRUCTION (SSL 2)

1. Deep open tread (AT) designed for excellent cleaning and traction. A deep layer of undertread means the core can be retreaded again and again.
2. Zero degree belts (under the tread) and proprietary design provide great lateral stiffness, while resisting damage and absorbing impacts.
3. Michelin's proprietary Comp10 Cable™ forms a semi-rigid "shear beam", and allows the load to hang from the top
4. Universal, 8 hole, interlocking heavy gauge steel hub for robust attachment to the machine.
5. High strength, poly-resin spokes carry the load and absorb impacts, help dampen the ride, and provide a unique energy transfer that reduces pneumatic bounce.



X[®] TWEEL[®] SSL 2



All Terrain



Hard Surface Traction



PRODUCTIVITY

- No downtime due to flat tires
- Outstanding stability contributes to high machine productivity



EXCELLENT DRIVER COMFORT

- Unique spoke design helps reduce “bounce” and driver fatigue associated with pneumatic tires



LONG PRODUCT LIFE

- Consistent footprint, with tread designed to last 2-3 times longer than a pneumatic tire at equal tread depth, and capable of being retreaded

MSPN	Description	Size	Max Load @ 15Km/h	Tread Depth	Undertread	Weight
07013	X [®] TWEEL [®] SSL 2 All Terrain	12N16.5	4,400 lbs.	31/32nds	12/32nds	211.0 lbs
45604	X [®] TWEEL [®] SSL 2 Hard Surface Traction	12N16.5	4,400 lbs.	48/32nds	8/32nds	240.0 lbs
93405	X [®] TWEEL [®] SSL 2 All Terrain	10N16.5	3,700 lbs.	31/32nds	10/32nds	160.0 lbs
69607	X [®] TWEEL [®] SSL 2 Hard Surface Traction	10N16.5	3,700 lbs.	48/32nds	10/32nds	190.0 lbs

Product measurements are subject to change and are listed here for your convenience. Please see your MICHELIN representative for up-to-date data.





X[®] TWEEL[®] TURF

AIRLESS RADIAL TIRE FOR
ZERO TURN RADIUS MOWERS

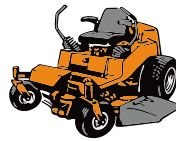

Zero Turn Radius Mowers

 Tweel.Michelinman.com



NO MORE FLAT TIRES

- Airless radial tire design eliminates downtime due to flat tires
- Available in sizes to fit a wide range of mowers



CONSISTENT HUB HEIGHT

- Helps ensure the mower deck produces an even cut



STABILITY & RIDER COMFORT

- Excellent lateral stability on hillsides and sloped surfaces, and outstanding operator comfort, even when navigating over curbs and other bumps



LONG WEAR LIFE

- High performance compounds and an efficient contact patch designed to provide a long wear life that is 2-3 times that of a pneumatic tire at equal tread depth

 **WARNING**

Use of incorrect mounting hardware can lead to separation of the TWEEL from the vehicle, loss of control, and serious injury or death

SIZES / SPECIFICATIONS

MSPN	Description	Size	Center Color	Max Load (lbs.)	Wheel Offset (in)	Bolt Pattern	Weight (lbs.)
01133	X TWEEL TURF	18x8.5N10	Black	529	-0.4	4x4 in.	28.4
37968	X TWEEL TURF	22x11N12	Black	529	-1.1	4x4 in.	38.3
47260	X TWEEL TURF	22x11N12 XL	Black	727	-1.375	5x4.5 in.	39.5
08755	X TWEEL TURF	22x11N12 XL	Black	727	-1.1	4x4 in.	40
22487	X TWEEL TURF	24x12N12	Black	750	0.9	4x4 in.	47.7
50357	X TWEEL TURF	24x12N12	Black	750	-0.75	4x4 in.	47.7
77185	X TWEEL TURF	24x12N12	Black	750	-2.2	4x4 in.	48.2
54411	X TWEEL TURF	24x12N12	Black	750	-1.3	5x4.5 in.	47.7
14365	X TWEEL TURF	24x12N12	Black	750	0.67	5x4.5 in.	47.7
59498	X TWEEL TURF	24x12N12	Black	750	-1.3	5x4.5 in.	48.5
06358	X TWEEL TURF	24x12N12 XL	Black	868	-2.2	4x4 in.	49.4
08189	X TWEEL TURF	26x12N12 XL	Black	1031	-0.87	4x4 in.	58.6
25913	X TWEEL TURF	26x12N12 XL	Black	1031	-2.2	5x4.5 in.	60.3
25926	X TWEEL TURF	26x12N12 XL	Black	1031	0.67	5x4.5 in.	59.4
75935	X TWEEL TURF	26x12N12 XL	Black	1031	1.7	10x8.5 in.	55.9
25926	X TWEEL TURF	26x12N12 XL	Black	1031	0.67	5x4.5 in.	59.4

Product measurements are subject to change and are listed here for your convenience. Please see your MICHELIN representative for up-to-date data.



X* TWEEL® TURF CASTER

AIRLESS RADIAL TIRE FOR
ZERO TURN RADIUS MOWERS

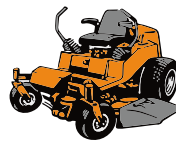

Zero Turn Radius Mowers

Tweel.Michelinman.com



FITS MOST MOWERS

- Integrated metal center hub with OEM quality sealed bearings, available for 5/8" and 3/4" diameter axle bolts
- Spacers available to adapt fit for a variety of popular mowers



RIDER COMFORT

- Unique circular outer beam functions like a spring, creating suspension like characteristics for the front of the mower



LONG WEAR LIFE

- Durable, polyresin tread helps provide long wear life



13" Grooved
Polyresin Tread



13" Smooth
Polyresin Tread



15" Smooth
Polyresin Tread

HUB DIAMETER / SPACERS

The TWEEL® caster is available for 5/8" and 3/4" diameter axle bolt diameters. Depending on axle diameter and fork width, spacers may be required for proper installation. Refer to the chart below for part numbers and dimensions. Additional fitment information is available at michelintweel.com.

SIZES / SPECIFICATIONS

MSPN	Description	Size	Tread	Max Load	Axle Bolt Dia.	Weight (lbs.)
73818	X* TWEEL® Turf Caster	13x6.5N6	Grooved	290	5/8"	12.5
52441	X* TWEEL® Turf Caster	13x6.5N6	Grooved	290	3/4"	12.3
41011	X* TWEEL® Turf Caster	13x6.5N6	Smooth	290	5/8"	12.6
05768	X* TWEEL® Turf Caster	13x6.5N6	Smooth	290	3/4"	12.4
49136	X* TWEEL® Turf Caster	15x6.0N6	Smooth	370	5/8"	15.4
31716	X* TWEEL® Turf Caster	15x6.0N6	Smooth	370	3/4"	15.2

MSPN	Item	Axle Bolt Diameter	Bushing Width	Assembly / Fork Inside Width
34578		1/2"	5/16"	6-3/8"
38182		1/2"	5/8"	7"
40653		1/2"	1"	7-3/4"
65019		3/4"	1"	7-3/4"
34193		5/8"	5/8"	For John Deere 997
30927		1/2"- 3/4"	2-1/8"	Bearing Dust Cap

WARNING Use of incorrect mounting hardware can lead to separation of the TWEEL from the vehicle, loss of control, and serious injury or death

Product measurements are subject to change and are listed here for your convenience. Please see your MICHELIN representative for up-to-date data.



X[®] TWEEL[®] ATV / UTV

AIRLESS RADIAL TIRE FOR ALL-TERRAIN
AND UTILITY-TERRAIN VEHICLES



UTVs / ATVs

Tweel.Michelinman.com



NO MORE FLAT TIRES

- Designed specifically for difficult environments and conditions where vehicles are exposed to rugged roads, jagged terrain and other elements hostile to ordinary tires



RIDER COMFORT & STABILITY

- Full width poly-resin spokes help dampen the ride for enhanced operator comfort, while providing outstanding lateral stiffness, excellent cornering and side-hill stability



OFF-ROAD TRACTION

- Low pressure contact patch helps provide outstanding off-road traction



X® TWEEL® UTV

SIZES / SPECIFICATIONS

26X9N 14 SIZE

MSPN	CAI	Description	Common Fitments	Size	Max Load	Max Speed	Bolt Pattern	True Offset	Industry Offset/ Backspace	Center Hole Dia.	Bolt Hole Dia.	Weight
68495	316179	X TWEEL ATV	Honda ATV	26x9N14	506 lbs	50 mph	4x110 mm	+45 mm	5+2	2.7 in	13 mm	50 lbs.
					230 kg	80 kph				68.5 mm		22.7 kg
67693	698296	X TWEEL UTV	Honda, Kubota RTV	26x9N14 69j	715 lbs	62 mph	4x110 mm	+52 mm	6+1	2.7 in	13 mm	57 lbs.
					325 kg	100 kph				68.5 mm		25.7 kg
65492	396708	X TWEEL UTV	Arctic Cat, Textron, CAT CUV	26x9N14 69j	715 lbs	62 mph	4x115 mm	+52 mm	6+1	2.7 in	13 mm	57 lbs.
					325 kg	100 kph				68.5 mm		25.7 kg
75085	278044	X TWEEL UTV	Most Polaris, Kawasaki Mule Pro 800	26x9N14 69j	715 lbs	62 mph	4x156 mm	+30 mm	4+3	5.2 in	13 mm	50 lbs.
					325 kg	100 kph				132 mm		22.7 kg
21709	421944	X TWEEL UTV	Most Can Am; Kawasaki Teryx, Mule 4010; John Deere XUV 590; Yamaha, Arctic Cat, others	26x9N14 69j	715 lbs	62 mph	4x137 mm	+48 mm	5+2	4.4 in	14.3 mm	50 lbs.
					325 kg	100 kph				112 mm		22.7 kg
49265	593299	X TWEEL UTV	John Deere XUV 835 and others; ARGO, General Dynamics	26x9N14 69j	715 lbs	62 mph	5x4.5"	+25 mm	4+3	3.13 in	13 mm	50 lbs.
					325 kg	100 kph				79.5 mm		22.7 kg

26X11N 14 SIZE

MSPN	CAI	Description	Common Fitments	Size	Max Load	Max Speed	Bolt Pattern	True Offset	Industry Offset/ Backspace	Center Hole Dia.	Bolt Hole Dia.	Weight
64998	199685	X TWEEL UTV	Honda, Kubota RTV	26x11N14	1323 lbs	62 mph	4x110 mm	+35 mm	6+4	2.7 in	13 mm	79 lbs.
					600 kg	100 kph				68.5 mm		35.8 kg
03488	417016	X TWEEL UTV	Arctic Cat, Textron, CAT CUV	26x11N14	1323 lbs	62 mph	4x115 mm	+35 mm	6+4	2.7 in	13 mm	79 lbs.
					600 kg	100 kph				68.5 mm		35.8 kg
82599	842835	X TWEEL UTV	Most Polaris, Kawasaki Mule Pro 800	26x11N14	1323 lbs	62 mph	4x156 mm	+42 mm	7+3	5.2 in	13 mm	79 lbs.
					600 kg	100 kph				132 mm		35.8 kg
29242	094026	X TWEEL UTV	Most Can Am; Kawasaki Teryx, Mule 4010; John Deere XUV 590; Yamaha, Arctic Cat, others	26x11N14	1323 lbs	62 mph	4x137 mm	+35 mm	6+4	4.4 in	14.3 mm	79 lbs.
					600 kg	100 kph				112 mm		35.8 kg
10545	812358	X TWEEL UTV	John Deere XUV 835 and others; ARGO, General Dynamics	26x11N14	1323 lbs	62 mph	5x4.5"	+40 mm	7+3	3.13 in	13 mm	79 lbs.
					600 kg	100 kph				79.5 mm		35.8 kg

Note: All UTV/ATVs use 60° / Conical / Tapered Lug Nuts.

Product measurements are subject to change and are listed here for your convenience. Please see your MICHELIN representative for up-to-date data.



MSPN 68495, 67693, 65492, 64998 & 03488



MSPN 75085 & 82599



MSPN 21709 & 29242



MSPN 49265 & 10545

WARNING

Use of incorrect mounting hardware can lead to separation of the TWEEL from the vehicle, loss of control, and serious injury or death



X° TWEEL® TURF GOLF CART

**AIRLESS RADIAL TIRE FOR GOLF CARTS
AND UTILITY VEHICLES**



[Tweel.Michelinman.com](https://www.Tweel.Michelinman.com)



SMOOTH RIDE

- Unique spoke design helps dampen the ride for enhanced rider comfort when driving over gravel, uneven pavement, and bumps



SIDE-HILL STABILITY

- Full width poly-resin spokes help provide outstanding lateral stiffness for excellent side-hill stability



LONG SERVICE LIFE AND EXCELLENT TRACTION

- Designed to provide excellent traction and long wear life – up to two times longer than a pneumatic golf cart tire



MSPN 01133
Golf cart hub
(includes center dust cap)



MSPN 78245
Utility vehicle hub
(shown on right)



WARNING Use of incorrect mounting hardware can lead to separation of the TWEEL from the vehicle, loss of control, and serious injury or death

SIZES / SPECIFICATIONS

MSPN	Description	Size	Wheel Offset	Max Speed	Max Load	Bolts/ Bolt Circle	Weight
01133	X° TWEEL® TURF for Golf Carts (Comfort)	18x8.5N10 (205/50N10)	-0.4 in	25 mph	529 lbs.	4x4 in.	28.4 lbs.
78245	X° TWEEL® TURF for Utility Carts	18x8.5N10 (205/50N10)	-0.4 in	25 mph	705 lbs.	4x4 in.	27.6 lbs.

Product measurements are subject to change and are listed here for your convenience. Please see your MICHELIN representative for up-to-date data.



SELECT A TIRE, USE AND OPERATION

Tire selection must comply with regulations and the equipment recommended by the manufacturers of the vehicle and equipment, or an official organization (size, load index and speed rating, structure – radial/bias, etc.). Consideration must be given to the conditions under which the tire is to be used so that its performance meets users' requirements.

When changing a vehicle's original equipment, make sure the planned solution meets current regulations, check the vehicle's constraints and the manufacturer's recommendations (refer to local legislation). In some countries, a vehicle modified in this way must receive authorization from the relevant authorities. MICHELIN tires are designed for a specific use. Any other use constitutes abnormal use. However in some cases, Michelin can authorize a waiver which will specify the accepted usage limits and conditions under the waiver. Michelin will not be held liable for abnormal use of its tires or use in the absence of any express, written waiver.

Prior to being fitted, all used or worn tires or tires involved in an accident must be thoroughly inspected by a professional to guarantee user safety and compliance with current regulations. Incorrect use or choice of tire may also contribute to some mechanical parts experiencing premature wear.

EQUIVALENCE CHART

Diameter	Up to medium powered tractors					HP tractors Harvester machines		Sprayers	
Rim	STANDARD WIDTH AGRIBIB, AGRIBIB 2		70 series OMNIBIB	65 series MULTIBIB	60 series XEOBIB	HIGH VOLUME / IND. AXIOBIB, AXIOBIB 2, MACHBIB, CEREXBIB CEREXBIB 2, MEGAXBIB, MEGAXBIB 2		ROW CROP AGRIBIB ROW CROP, YELDBIB, SPRAYBIB	
inches	inches	mm	mm	mm	mm	mm	mm	inches	mm
20	12.4 R20	320/85 R20	360/70 R20	420/65 R20					
24	9.5 R24	250/85 R24	300/70 R24						
20	13.6 R20	380/75 R20	380/70 R20	440/65 R20					
24	11.2 R24	280/85 R24	320/70 R24						
24	12.4 R24	320/85 R24	360/70 R24	420/65 R24					
28	9.5 R28	250/85 R28		340/65 R28					
24	13.6 R24	340/85 R24	380/70 R24	440/65 R24			400/70 R24		
28	11.2 R28	280/85 R28	320/70 R28					8.3 R32	210/95 R32
24	14.9 R24	380/85 R24	420/70 R24	480/65 R24			460/70 R24		
26	13.6 R26							9.5 R32	230/95 R32
28	12.4 R28	320/85 R28	360/70 R28	420/65 R28					
24	16.9 R24	420/85 R24	480/70 R24	540/65 R24					
26	14.9 R26							11.2 R32	270/95 R32
28	13.6 R28	340/85 R28	380/70 R28	440/65 R28	480/60 R28			8.3 R36	210/95 R36
24	18.4 R24						500/70 R24		
26	16.9 R26		480/70 R26	540/65 R26					
28	14.9 R28	420/75 R28						12.4 R32	320/85 R32
		380/85 R28	420/70 R28	480/65 R28	520/60 R28			9.5 R36	230/95 R36
26	18.4 R26					580/70 R26	750/50 R26		
28	16.9 R28	420/85 R28	480/70 R28	540/65 R28	600/60 R28			11.2 R36	320/85 R34
30	14.9 R30	380/85 R30	420/70 R30					9.5 R38	270/95 R36
									230/95 R38
26							520/80 R26	12.4 R36	320/85 R36
28	18.4 R28	540/75R28					600/65 R28	11.2 R38	270/95 R38
		480/75 R30						9.5 R40	230/95 R38
30	16.9 R30	420/85 R30	480/70 R30	540/65 R30	600/60 R30		710/55 R30		
26							620/70 R26		
28							600/70 R28		
30	18.4 R30	420/90 R30	520/70 R30	600/65 R30				13.6 R36	340/85 R36
		460/85 R30						8.3 R44	320/85 R38
34	14.9 R34	380/85 R34							420/90 R30
38	12.4 R38	320/85 R38							210/95 R44
									380/85 R34
26	23.1 R26					620/75 R26	750/65 R26		
28	28L R26								
30					710/60 R30			11.2 R42	420/85 R34
32								9.5 R44	270/95 R42
34	16.9 R34	420/85 R34	480/70 R34	540/65 R34	600/60 R34			13.6R38	230/95 R44
									380/80R38
38	13.6 R38	340/85 R38							
		380/80 R38							
25		400/75 R38					1000/50 R25		
30	23.1 R30					520/85 R30	650/70 R30	11.2 R44	380/95 R38
						620/70 R30	710/65 R30	9.5 R48	320/90 R42
						620/75 R30			270/95 R44
34	18.4 R34	460/85 R34	520/70 R34	600/65 R34		600/70 R34	650/60 R34		270/90 R46
		520/75 R34					710/55 R34		230/95 R48
		540/75 R34							
38	14.9 R38	380/85 R38							
30	16.9 R38	420/85 R38	480/70 R38	540/65 R38	600/60 R38				
32	24.5 R32					650/75 R32	680/70 R32	12.4 R46	270/95 R46
							800/60 R32	13.6 R46	320/90 R46
34	20.8 R34						650/65 R34	11.2 R48	340/85 R46
							710/60 R34		270/95 R48
38	18.4 R38	460/85 R38	520/70 R38	600/65 R38	650/60 R38				270/85 R50
32	30.5L R32					680/75 R32	900/55 R32		
							900/60 R32		
							1050/50 R32		
34						650/75 R34	750/65 R34	14.9 R46	380/90 R46
							680/70 R34	13.6 R48	420/80 R46
									340/85 R48
38	20.8 R38	520/85 R38	580/70 R38	650/65 R38	710/60 R38	620/70 R38	650/65 R38		300/95 R50
							710/60 R38		320/90 R50
42	18.4 R42	460/85 R42		600/65 R42					480/80 R42
		480/80 R42							
32						680/85 R32	800/70 R32		
							900/60 R32		
34							710/75 R34		
38						650/75 R38	710/70 R38	12.4 R 52	380/90 R50
							750/65 R38	11.2 R54	300/95 R52
42	20.8 R42	520/85 R42	580/70 R42	650/65 R42	710/60 R42		520/85 R42		270/95 R54
			620/70 R42				620/70 R42		320/90 R54
							900/50 R42		480/80 R46
46	18.4 R46	460/85 R46							
		480/80 R46							
38						650/85 R38	800/70 R38		
							900/60 R38		
42		580/85 R42				710/70 R42	800/65 R42		380/90 R54
							580/85 R42		420/95 R50
46	20.8 R46	520/85 R46		650/65 R46			620/70 R46		480/80 R50
38						710/85 R38			
42						710/75 R42	900/60 R42		480/95 R50
46						750/75 R46	900/65 R46		

ROLLING CIRCUMFERENCE INDEX / SPEED RADIUS INDEX CHART

Rim	Tire Size	MSPN	OD	Weight (lbs.)	RCI	SRI
AGRIBIB (see pages 2-11)						
24	9.5 R24	07126	41.1	69	35	500
24	11.2 R24	92311	43.1	88	36	525
24	12.4 R24	78449	45.2	111	37	550
24	13.6 R24	06947	47.2	134	38	575
24	14.9 R24	92158	49.8	159	-	600
24	16.9 R24	97341	52.4	204	-	625
28	12.4 R28	20895	49.8	130	-	600
28	13.6 R28	87976	51.5	150	39	625
28	14.9 R28	25543	53.7	182	40	650
28	16.9 R28	13991	56.5	226	-	675
30	16.9 R30	41545	58.3	218	42	700
30	18.4 R30	42060	61	255	-	725
30	380/85 R30	18784	55.7	179	41	675
30	420/90 R30	68713	60.4	243	42	725
34	18.4 R34	71754	65.4	279	44	775
34	320/85 R34	73532	55.9	157	41	675
34	380/85 R34	59412	59.2	192	42	725
34	420/85 R34	30127	62.8	239	43	750
36	12.4 R36	03338	57.5	136	41	700
38	12.4 R38	15336	59.1	140	42	725
38	13.6 R38	66666	61.6	187	43	750
38	18.4 R38	63603	69.7	309	45	825
38	20.8 R38	17548	72.8	390	46	875
38	380/95 R38	65207	66.5	246	-	800
38	420/85 R38	84239	66	264	44	800
38	520/85 R38	43308	73	406	46	875
42	480/80 R42	03395	73.1	380	46	875
42	520/85 R42	63687	76.6	446	47	925
46	420/80 R46	58733	73.7	320	46	925
46	480/80 R46	94069	76.6	404	47	925
46	520/85 R46	57479	80.7	475	48	975
50	480/80 R50	94576	80.9	444	48	975
50	480/95 R50	54736	85.6	518	-	1075
AGRIBIB 2 (see pages 12-20)						
20	280/85 R24	28293	43.0	90	-	525
24	320/85 R24	04692	45.2	111	37	550
24	340/85 R24	43288	47.3	134	-	575
24	380/85 R24	70692	49.3	159	-	600
24	420/85 R24	80487	52.8	203	-	625
26	480/80 R26	N/A	56	-	46	875
28	280/85 R28	40217	46.9	101	-	575
28	340/85 R28	14834	51.5	150	-	625
28	380/85 R28	12989	53.6	179	40	650
28	420/85 R28	43824	55.9	223	41	675
30	380/85 R30	72163	55.7	176	41	675
30	420/85 R3	72159	58.5	209	-	700
30	420/90 R30	71308	59.8	232	42	725
30	460/85 R30	09713	61.3	256	-	725

Rim	Tire Size	MSPN	OD	Weight (lbs.)	RCI	SRI
32	650/75 R32	N/A	72	-	44	775
34	320/85 R34	32034	55.9	154	41	675
34	380/85 R34	84143	59.7	198	42	725
34	420/85 R34	16801	62.6	232	43	750
34	460/85 R34	32288	65.0	280	-	775
38	340/85 R38	29111	61.3	187	-	750
38	380/80 R38	59112	62.8	201	43	750
38	420/85 R38	11069	66.5	254	44	800
38	460/85 R38	75852	69.6	309	45	825
38	520/85 R38	5183	72.8	397	46	875
42	480/80 R42	5745	72.4	331	46	875
42	520/85 R42	13435	77.1	412	47	925
46	420/80 R46	13581	73	287	46	925
46	480/80 R46	639	76.6	353	47	925
46	520/85 R46	17697	81.1	419	48	975
50	480/80 R50	41183	80.7	406	48	975
54	380/90 R54	28485	80.9	295	48	1025
AGRIBIB Row Crop (see pages 98-101)						
38	320/85 R38	50528	59.4	181	42	725
38	IF 320/85 R38	20864	59.3	187	42	725
42	320/90 R42	64720	64.5	209	44	800
46	340/85 R46	94547	68.8	225	45	825
46	380/90 R46	38865	73.4	304	46	925
46	IF 380/90 R46	84037	72.5	313	46	925
50	320/90 R50	95098	72.7	248	46	925
50	380/90 R50	15852	76.2	319	47	975
50	IF 320/90 R50	00912	73.1	254	46	925
50	IF 380/90 R50	88459	76.9	324	47	975
54	320/90 R54	96185	76.8	261	47	975
54	IF 320/90 R54	59155	76.7	267	47	975
AXIOBIB (see pages 32-36)						
30	IF 600/70 R30	96393	62.4	426	43	750
30	IF 620/75 R30	96772	65.7	470	44	800
30	IF 650/75 R30	96826	67.8	516	45	825
34	IF 650/60 R34	94599	65.4	474	-	775
34	IF 650/65 R34	26241	67.8	516	-	825
34	IF 710/60 R34	67777	66.8	549	-	825
38	IF 650/65 R38	87017	71.9	551	-	875
38	IF 650/85 R38	97250	80.7	777	-	875
38	IF 710/60 R38	69189	72.6	617	46	875
38	IF 710/85 R38	99013	85	849	49	1025
38	IF 800/70 R38	99142	81.4	862	48	975
42	IF 710/70 R42	99783	81.2	761	48	975
42	IF 710/75 R42	25479	85.1	818	49	1025
42	IF 900/60 R42	82481	83.6	1017	49	1025
46	IF 750/75 R46	07217	90	860	50	1125
46	IF 900/65 R46	36973	91.4	1147	50	1125

ROLLING CIRCUMFERENCE INDEX / SPEED RADIUS INDEX CHART

Rim	Tire Size	MSPN	OD	Weight (lbs.)	RCI	SRI
AXIOBIB 2 (see pages 32-36)						
30	VF 540/65 R30	06869	57.5	320	-	700
30	VF 600/60 R30	06116	57.8	370	42	700
30	VF 600/70 R30	32376	62.2	441	-	750
30	VF 620/75 R30	20861	65.7	470	44	800
34	VF 650/60 R34	39440	65.1	485	-	775
34	VF 650/65 R34	79000	67.3	531	-	825
34	VF 710/60 R34	99540	68	567	-	825
38	VF 650/60 R38	44502	68.6	-	45	825
38	VF 650/85 R38	18612	81.2	791	-	975
38	VF 800/70 R38	86394	81.6	877	-	975
42	VF 650/65 R42	43835	75.6	540	47	925
42	VF 650/85 R42	06000	85.2	860	49	1025
42	VF 710/60 R42	78256	74.2	692	47	925
42	VF 710/70 R42	01871	81.3	785	48	975
42	VF 710/75 R42	01608	84.8	849	49	1025
42	VF 900/60 R42	17679	85	1047	49	1025
44	VF 750/70 R44	85966	85.8	915	-	1025
CARGOXBIB (see pages 113-115)						
22.5	600/50 R22.5	94336	46.5	265	-	550
26.5	800/45 R26.5	81371	54.9	401	-	675
30.5	600/60 R30.5	51915	58.9	386	-	700
30.5	710/50 R30.5	92209	58.9	437	-	700
30.5	800/45 R30.5	53255	58.9	454	-	725
30.5	850/50 R30.5	69986	64.1	538	-	775
CARGOXBIB 2 (see page 115)						
22.5	600/50 R22.5	88721	46.5	265	-	550
CARGOXBIB Heavy Duty (see pages 111-112)						
22.5	500/60 R22.5	36343	46.1	223	-	550
22.5	560/45 R22.5	27334	42.5	221	-	525
22.5	560/60 R22.5	20379	48.9	247	-	600
CARGOXBIB High Flotation (see pages 107-110)						
22.5	710/45 R22.5	6153	47.6	293	-	575
26	28 LR26	986	62.2	512	-	-
26.5	600/55 R26.5	32505	53	326	41	675
26.5	650/55 R26.5	15666	55	437	-	825
26.5	710/50 R26.5	29880	54	371	47	925
26.5	VF600/55 R26.5	28332	52.8	326	-	625
26.5	VF650/55 R26.5	33527	55.2	357	-	725
26.5	VF710/50 R26.5	20991	54.3	375	-	650
30.5	650/65 R30.5	28171	63.9	463	-	775
30.5	750/60 R30.5	77049	66	529	-	825
30.5	VF750/60 R30.5	8620	65.9	529	-	800
32	800/60 R32	50441	70.9	617	-	875
CEREXBIB (see page 73-77)						
26	VF 520/80 R26 CFO	61911	58.7	328	-	700
26	VF 620/70 R26 CFO	64298	59.6	390	42	725
26	VF 750/65 R26 CFO	2320	63.9	526	-	750
30	VF 520/85 R30 CFO	66188	63.9	294	46	775
30	VF 620/70 R30 CFO	92780	63.6	423	-	775
32	IF 680/85 R32 CFO	18128	76.2	665	47	925

Rim	Tire Size	MSPN	OD	Weight (lbs.)	RCI	SRI
32	IF 800/65 R32 CFO	39571	73	749	46	875
32	IF 800/70 R32 CFO	18258	77.1	816	-	925
32	IF 900/60 R32 CFO	3456	75	805	-	925
32	IF 1000/55 R32 CFO	22858	76	981	-	925
38	IF 680/75 R38 CFO	2720	77.4	639	-	975
38	IF 800/70 R38 CFO	39234	80	851	-	550
38	IF 800/70 R38 CFO	24897	80.7	851	48	975
38	IF 900/60 R38 CFO	14429	80	937	47	925
38	IF 900/60 R38 CFO	3936	79.9	937	48	975
42	VF 520/85 R42 CFO	78620	76.9	578	47	925
42	IF 710/70 R42 CFO	61530	82.6	798	-	975
CEREXBIB 2 (see pages 68-72)						
26	VF 520/80 R26 CFO+	24394	58.7	328	-	700
26	VF 620/70 R26 CFO+	98039	59.6	390	42	725
26	VF 750/65 R26 CFO+	33777	63.9	523	-	750
30	VF 520/85 R30 CFO+	86907	63.9	395	-	775
30	VF 620/70 R30 CFO+	53106	63.6	423	-	775
30	VF 710/65 R30 CFO+	22560	66	485	44	800
32	IF 800/65 R32 CFO+	25367	73	740	-	875
32	IF 800/70 R32 CFO+	71535	76.8	772	-	925
32	VF 900/60 R32 CFO+	73624	74.9	805	-	925
34	VF 500/85 R34 CFO+	29877	66	419	-	825
38	IF 680/80 R38 CFO+	20691	79.5	730	-	975
38	IF 800/70 R38 CFO+	25474	80.7	847	48	975
38	VF 900/60 R38 CFO+	31193	79.9	948	-	975
38	VF 900/60 R38 CFO+	68766	79.8	948	-	975
42	VF 520/85 R42 CFO+	15337	76.9	578	-	925
42	VF 580/85 R42 CFO+	45547	80.3	617	-	975
42	VF 710/70 R42 CFO+	60118	82.6	798	-	975
42	IF 800/70 R42 CFO+	91180	84.7	926	49	1025
42	VF 900/60 R42 CFO+	3717	83.4	970	-	1025
FLOATXBIB (see pages 78-80)						
25	VF 1000/50 R25 CFO	20271	64.7	820	-	775
26	VF 750/50 R26 CFO	10112	55.3	478	-	675
32	IF 1000/55 R32 CFO	21874	73.9	977	-	925
32	VF 1000/55 R32 CFO	22389	73.9	992	-	925
38	VF 900/60 R38 CFO	02123	80.3	849	-	975

ROLLING CIRCUMFERENCE INDEX / SPEED RADIUS INDEX CHART

Rim	Tire Size	MSPN	OD	Weight (lbs.)	RCI	SRI
MACHXBIB (see pages 25–31)						
28	600/65 R28	86350	58.5	363	41	675
28	600/65 R28	44562	58.8	353	48	975
28	600/70 R28	46139	62.4	399	-	550
28	600/70 R28	29237	61.9	397	-	725
30	600/70 R30	68124	63.1	441	43	750
30	600/70 R30	76077	63.2	415	43	750
30	710/55 R30	3784	59.8	433	-	725
32	680/75 R32	80305	73.4	605	46	876
34	650/60 R34	96892	65.5	485	-	775
34	650/65 R34	93805	68	485	-	825
38	650/75 R38	86829	76.7	659	47	925
38	650/75 R38	70375	76.7	717	47	925
38	650/85 R38	89462	81.2	720	48	975
38	650/85 R38	38067	81.7	780	48	975
38	710/70 R38	30751	77.7	648	47	925
38	800/70 R38	29390	81.3	807	48	975
42	710/70 R42	31962	82.2	741	48	975
42	710/75 R42	13444	85	849	-	1025
42	900/50 R42	3779	77.6	792	47	975
46	620/70 R46	69879	81.1	637	48	975
46	620/70 R46	1175	80.2	639	48	975
MEGAXBIB (see pages 85–90)						
26	620/75 R26	89936	63.1	415	43	750
26	750/50 R26	67149	55	408	-	-
26	750/65 R26	36798	63.8	527	0	750
30	620/75 R30	63928	67.3	454	44	800
32	650/75 R32	46686	71.9	538	45	875
32	800/65 R32	49342	72.4	697	46	875
32	800/70 R32	68880	76.2	809	-	925
32	900/60 R32	40581	74.6	847	46	925
32	1050/50 R32	94737	74.9	993	46	875
32	1050/50 R3	28613	73	899	-	-
34	620/75 R34	83734	71.4	500	-	825
34	710/75 R34	13589	74.8	655	47	925
38	620/70 R38	99512	73.4	562	46	875
38	650/85 R38	19212	80.6	776	48	975
42	520/85 R42	15488	76.8	512	47	925
42	620/70 R42	15145	77.2	512	47	925
MEGAXBIB 2 (see pages 81–84)						
25	1000/50 R25	76362	65.1	765	-	750
26	750/50 R26	81321	55.4	408	-	675
32	650/75 R32	38157	72.3	538	-	875
32	800/65 R32	87985	72.4	697	-	875
32	800/70 R32	85778	76.3	809	-	925
32	900/60 R32	04361	74.8	847	-	925
32	1050/50 R32	12011	73.5	847	-	875
34	710/75 R34	47924	74.6	655	47	925
38	620/70 R38	40381	73.5	562	-	875

Rim	Tire Size	MSPN	OD	Weight (lbs.)	RCI	SRI
MULTIBIB (see pages 43–50)						
16	320/65 R16	39517	32.6	65	-	390
18	320/65 R18	78520	34.4	-	-	410
18	340/65R18	20099	35.7	79	32	425
20	420/65 R20	86582	41.9	-	35	500
20	440/65 R20	15810	42.9	142	-	525
24	420/65 R24	11709	45.5	121	-	550
24	420/65 R24	77842	45.7	128	-	550
24	440/65 R24	4039	46.7	163	-	575
24	480/65 R24	3176	48.8	179	38	600
24	540/65 R24	8801	51.7	232	-	625
28	420/65 R28	62700	48.7	-	-	600
28	440/65 R28	96372	50.8	182	39	625
28	480/65 R28	14369	52.7	198	-	625
28	540/65 R28	36062	56.2	252	41	675
30	540/65 R30	28553	58	285	-	700
34	540/65 R34	22243	62	278	43	750
34	540/65 R34	99445	62.6	278	43	750
34	600/65 R34	16291	65.1	374	44	775
38	540/65 R38	28857	65.9	322	44	800
38	600/65 R38	29767	69.6	410	45	825
38	650/65 R38	12871	71.6	456	46	875
42	650/65 R42	38881	76	507	47	925
MULTIBIB Plus (see page 50)						
38	650/65 R38	41949	72	467	46	875
42	650/65 R42	37632	76.2	500	47	925
OMNIBIB (see pages 51–56)						
16	280/70 R16	37920	31.7	53	-	390
20	280/70 R20	30655	35.6	64	32	450
24	320/70 R24	25416	43.3	105	-	525
24	360/70 R24	45416	45.4	125	37	550
24	380/70 R24	64778	46.8	141	38	575
24	420/70 R24	28067	49.3	168	39	600
24	480/70 R24	2475	52.2	205	-	625
28	380/70 R28	24723	50.9	159	39	625
28	420/70 R28	25705	53.3	187	40	650
28	480/70 R28	27084	56.2	243	41	675
30	480/70 R30	27236	58.3	243	42	700
34	480/70 R34	25021	62.7	270	43	750
34	520/70 R34	29601	65	325	44	775
38	480/70 R38	28503	66.7	302	44	800
38	520/70 R38	28089	69.5	368	45	825
38	580/70 R38	31198	72.3	439	46	875
42	620/70 R42	31015	76.9	513	47	925

ROLLING CIRCUMFERENCE INDEX / SPEED RADIUS INDEX CHART

Rim	Tire Size	MSPN	OD	Weight (lbs.)	RCI	SRI
ROADBIB (see pages 61-64)						
30	540/65 R30	92680	57.6	331	-	700
30	600/70 R30	15131	61.8	441	-	750
30	600/70 R30	73799	63.6	452	-	750
34	650/60 R34	90034	65	507	-	775
34	650/65 R34	35720	67	507	-	825
42	650/65 R42	37067	76.1	551	-	925
42	710/70 R42	27650	79.8	772	-	975
42	710/70 R42	03331	81.7	794	-	975
42	710/75 R42	14014	84.3	882	-	1025
SPRAYBIB (see pages 91-97)						
34	VF 420/90 R34 CFO	29015	63.4	337	-	-
38	VF 380/80 R38	93213	62.1	271	-	750
38	VF 380/80 R38 CFO	15109	62.4	280	43	750
42	VF 320/90 R42	44635	64.4	220	-	800
42	VF 480/80 R42	13814	72.4	381	46	875
42	VF 480/80 R42 CFO	82649	72.6	390	46	875
46	VF 320/90 R46	18963	68.3	258	-	825
46	VF 320/90 R46 CFO	31829	68.5	273	-	825
46	VF 380/90 R46	27358	72.5	333	46	925
46	VF 380/90 R46 CFO	20857	72.6	337	46	925
46	VF 480/80 R46	21151	76.5	404	47	925
46	VF 480/80 R46 CFO	92012	76.5	412	47	925
50	VF 320/90 R50	99896	72.6	276	-	925
50	VF 320/90 R50 CFO	21940	72.8	298	46	875
50	VF 380/90 R50	28608	76.8	353	47	975
50	VF 380/90 R50 CFO	16655	76.8	368	47	975
50	VF 420/95 R50	82545	80.8	418	48	1025
50	VF 420/95 R50 CFO	53951	81.1	423	48	975
50	VF 480/80 R50	50045	80.5	429	48	975
50	VF 480/80 R50 CFO	50314	80.5	456	48	975
54	VF 320/90 R54	45449	76.8	315	47	975
54	VF 320/90 R54 CFO	01344	77.0	320	-	925
54	VF 320/105 R 54	48439	79.8	353	48	-
54	VF 380/90 R54	47923	80.7	408	48	1025
54	VF 380/90 R54 CFO	31205	80.7	412	48	975
TRAILXBIB (see pages 102-106)						
22.5	VF 500/60 R22.5	2997	46.2	229	-	-
22.5	VF 560/60 R22.5	41626	48.9	265	-	600
22.5	VF 600/50 R22.5	4220	46.1	265	-	-
22.5	VF 710/45 R22.5	64711	47.8	293	-	-
26.5	VF 600/55 R26.5	41893	53.2	326	-	-
26.5	VF 650/55 R26.5	37535	55.2	359	-	725
26.5	VF 650/65 R26.5	86356	60.0	364	-	725
30.5	VF 600/60 R30.5	30202	58.7	386	-	725
26.5	VF 710/50 R26.5	39765	54.3	368	-	-
30.5	VF 650/65 R30.5	2919	64.3	470	-	-
30.5	VF 710/50 R30.5	22998	58.6	430	-	700
30.5	VF 750/60 R30.5	20302	66.1	538	-	-
30.5	VF 850/50 R30.5	79539	64.0	538	-	775

Rim	Tire Size	MSPN	OD	Weight (lbs.)	RCI	SRI
XEOBIB (see pages 57-60)						
28	VF 480/60 R28	80140	51.1	206	-	625
28	VF 520/60 R28	80236	52.7	236	-	650
28	VF 600/60 R28	80297	56.3	295	-	675
30	VF 600/60 R30	03690	58.8	310	-	700
34	VF 600/60 R34	78329	62.8	349	43	750
38	VF 600/60 R38	80626	66.9	386	44	800
38	VF 650/60 R38	80851	68.3	460	45	825
38	VF 710/60 R38	81759	71.4	542	46	875
42	VF 650/60 R42	10918	72.4	553	-	875
42	VF 710/60 R42	94391	75.6	588	47	925
XP27 (see pages 116-117)						
16	270/65R16	04629	29.7	49	-	360
18	270/65R18	98595	31.9	56	-	390
18	340/65R18	08185	35.1	78	32	425
XS (see pages 118-119)						
20.5	24 R 20.5	44650	54.1	-	-	650
20.5	525/65 R 20.5	71848	47.2	-	-	575
YELDBIB (see pages 21-24)						
34	VF 380/85 R34	91239	59.4	232	43	725
34	VF 420/85 R34	58965	62.3	277	43	750
38	VF 380/80 R38	35470	62.7	250	43	750
38	VF 380/95 R38	47253	67	282	44	800
46	VF 480/80 R46	10807	76.1	415	47	925
50	VF 480/80 R50	02098	80.3	448	48	975
50	VF 480/95 R50	65206	86.1	518	49	1075

TIRE SIDEWALL MARKINGS

WHAT DO THE MARKINGS ON A TIRE MEAN?



XeoBib
VF = Very High Flexion
650
60
R
38
155
D
Radial
Tubeless
Michelin® X®

Range
 Prefix designating a standardized category of tires
 Nominal section width of the tire in mm
 Aspect ratio (ratio between sidewall height/nominal tire section) as a %
 Construction: "R" for radial "-" for bias
 Nominal rim diameter in inches
 Standardized load index (see page 9)
 Standardized speed index (see page 9)
 Type of tire construction (casing)
 A tire can be fitted without a tube
 Registered Trademark

TIRE RANGE DIAGRAM

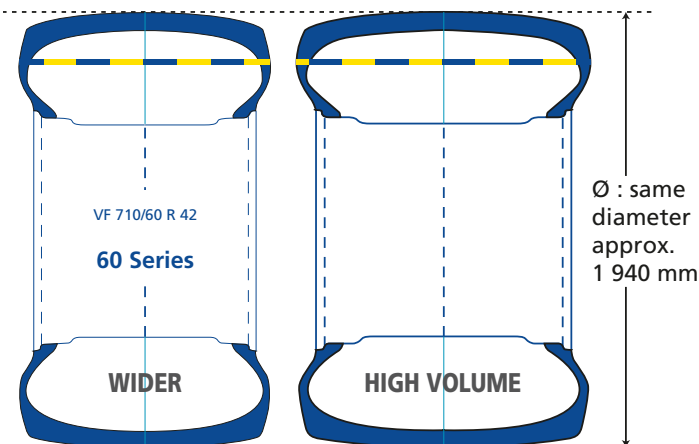
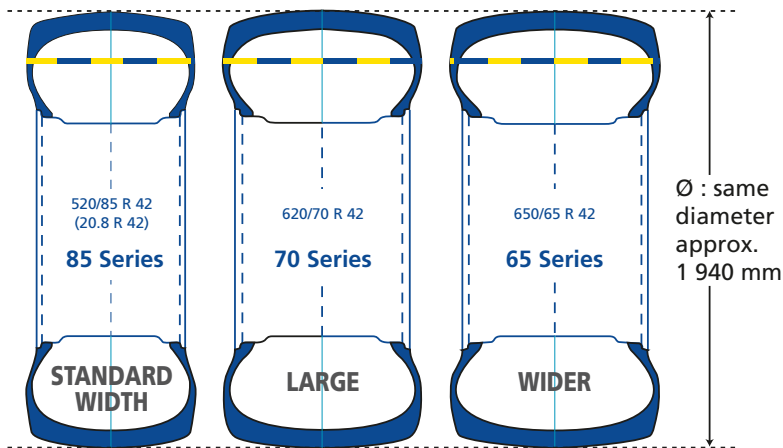

TIRE DIMENSIONS

- S Tire section width
- R' Radius with static load
- R Free radius
- D Overall diameter = 2 x free radius

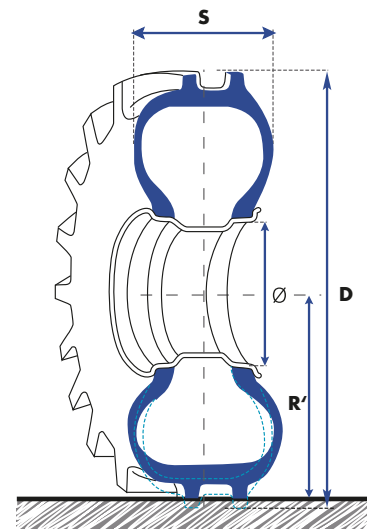

LOAD INDICES AND SPEED RATINGS

All tires carry a service description made up of the load index (a number) and the speed symbol (letter or letter with figure). The tables below show the tire load indices and speed symbols with their corresponding capacities.

LOAD INDICES

Index	Load		Index	Load		Index	Load		Index	Load	
	kg	lbs		kg	lbs		kg	lbs		kg	lbs
100	800	1764	126	1700	3748	152	3550	7826	178	7500	16535
101	825	1819	127	1750	3858	153	3650	8047	179	7750	17086
102	850	1874	128	1800	3968	154	3750	8267	180	8000	17637
103	875	1929	129	1850	4079	155	3875	8543	181	8250	18188
104	900	1984	130	1900	4189	156	4000	8818	182	8500	18739
105	925	2039	131	1950	4299	157	4125	9094	183	8750	19290
106	950	2094	132	2000	4409	158	4250	9370	184	9000	19842
107	975	2150	133	2060	4542	159	4375	9645	185	9250	20393
108	1000	2205	134	2120	4674	160	4500	9921	186	9500	20944
109	1030	2271	135	2180	4806	161	4625	10196	187	9750	21495
110	1060	2337	136	2240	4938	162	4750	10472	188	10000	22046
111	1090	2403	137	2300	5071	163	4875	10748	189	10300	22708
112	1120	2469	138	2360	5203	164	5000	11023	190	10600	23369
113	1150	2535	139	2430	5357	165	5150	11354	191	10900	24030
114	1180	2601	140	2500	5512	166	5300	11685	192	11200	24692
115	1215	2679	141	2575	5677	167	5450	12015	193	11500	25353
116	1250	2756	142	2650	5842	168	5600	12346	194	11800	26015
117	1285	2833	143	2725	6008	169	5800	12787	195	12150	26786
118	1320	2910	144	2800	6173	170	6000	13228	196	12500	27558
119	1360	2998	145	2900	6393	171	6150	13558	197	12850	28329
120	1400	3086	146	3000	6614	172	6300	13889	198	13200	29101
121	1450	3197	147	3075	6779	173	6500	14330	199	13600	29983
122	1500	3307	148	3150	6945	174	6700	14771	200	14000	30865
123	1550	3417	149	3250	7165	175	6900	15212	201	14500	31967
124	1600	3527	150	3350	7385	176	7100	15653	202	15000	33069
125	1650	3638	151	3450	7606	177	7300	16094	203	16000	35274

SPEED RATINGS

Code	Speed in km/h	Speed in mph
A2	10	6
A5	25	15
A6	30	19
A8	40	25
B	50	30
D	65	40
E	70	44
F	80	50
G	90	56
J	100	62

UNIT OF MEASUREMENT

Measurement	Name	Equivalent	Measurement	Name	Equivalent
1 centimeter	cm	= 0.3937 inch	1 inch	in	= 2.54 cm
1 meter	m	= 3.281 feet	1 foot	ft	= 0.3048 m
1 kilometer	km	= 0.6214 mile	1 mile	ml	= 1.6093 km
1 liter	l	= 0.2199754 imp gallon	1 imp. gallon	imp. gal.	= 4.545963 liters
1 kilogram	kg	= 2.204622 pounds	1 pound	lb	= 0.4535924 kg
1 horse power	hp	= 735.499 W	1 kilowatt	kw	= 1.3596216173 hp
1 bar	bar	= 14.5037738 psi	1 bar	bar	= 100 kPa (kilo Pascal)
1 pound per square inch	psi	= 6.89476 kPa	1 Acre imp.		= 0.4046842 ha
1 hectare	ha	= 2.4711 acre imp.	1 square inch (imp.)	sq in	= 6.451578 cm ²
1 square centimeter	cm ²	= 0.1550 sq.in (imp.)	1 ton	t	= 0.9842064 tn (imp)
1 ton (imp)	tn	= 1.016047	1 kilometer/hour	km/h	= 0.62137 mph
1 mile per hour	mph	= 1.609344 km/h			

OPERATING INSTRUCTIONS

TO DETERMINE THE TIRE PRESSURE

- Tire pressure is always determined in relation to load per tire, speed and work to be carried out.
- The load used is the highest:
 - For tractors:
 - › front axle: tractor with its weights / front equipment in the transport position and no rear axle load
 - › rear axle: tractor with equipment in the transport position.

Note: for a tractor equipped with a front loader, assume max. load on the loader.
 - For harvesters: full load (full hopper) with cutting bar (or picker). **Note** – for harvesters, determine the axle load:
 - › front axle with fully loaded bin and head attached, use cyclic loading speed schedule and pressure.
 - › front axle with folding head, empty bin using road speed schedule and pressure.
 - › rear axle without the cutter bar or picker
- Determine the pressure for «field use» and «road use» and select the higher of the two.
- For intensive road use or on slopes and inclines, follow the instructions given in “Technical specifications of MICHELIN tires”.

WHEN IN USE

- Spread loads correctly.
- Adapt your driving to the conditions (load, speed, slope, incline, condition of road or other terrain).

MAINTENANCE GUIDELINES

- Check tire pressure regularly.
- Periodically check the condition of your tires and have them checked by a trained and qualified professional

Reminder:

- Damage caused by a puncture or an impact may only become apparent after some time
 - Tires age even when not in use
- Have any repairs carried out by a trained and qualified professional.

CALCULATION OF MECHANICAL LEAD

4-WHEEL DRIVE / MECHANICAL LEAD

For a 4-wheel drive tractor's transmission unit to operate correctly, the correct mechanical lead must be used. This rule does not apply in the case of 4 wheels of the same size.

Most tractor manufacturers impose a mechanical lead of between 0% and 6%. This lead is specific, and may vary depending on the manufacturer and the vehicle.

An inappropriate mechanical lead ratio:

- increases fuel consumption,
- results in more rapid front and rear tire wear,
- results in more rapid wear on the transmission unit,
- results in poor tractor performance when doing some jobs (e.g. ploughing)

and causes:

- abrupt front axle engagement,
- a loss in power and performance,
- deterioration of the top soil.

Note: The front axle must never be engaged on the road!



CALCULATION OF MECHANICAL LEAD

$$\frac{(\text{RC Front} \times \text{R}) - \text{RC Rear}}{\text{RC Rear}} \times 100 = \text{mechanical lead in \%}$$

RC Rear: Rear tire rolling circumference (specified in the technical documentation)

RC Front: Front tire rolling circumference (specified in the technical documentation)

R: inter-axle ratio (This is fixed initially by the manufacturer)

Step 1:

Put marks on the tires as picture above.

Step 2:

FRONT AXLE NOT ENGAGED (out of 4WD)

Do 10 turns of rear tires and count the number **N** of turns for front.

Step 3:

FRONT AXLE ENGAGED (in 4WD)

Do 10 turns of rear tires and count the number **N1** of turns for front.

$$\text{Calculation of measurement} = \frac{(\text{N1} - \text{N})}{\text{N}} \times 100$$

LOAD-BALANCING CALCULATION

SINGLE FITMENT

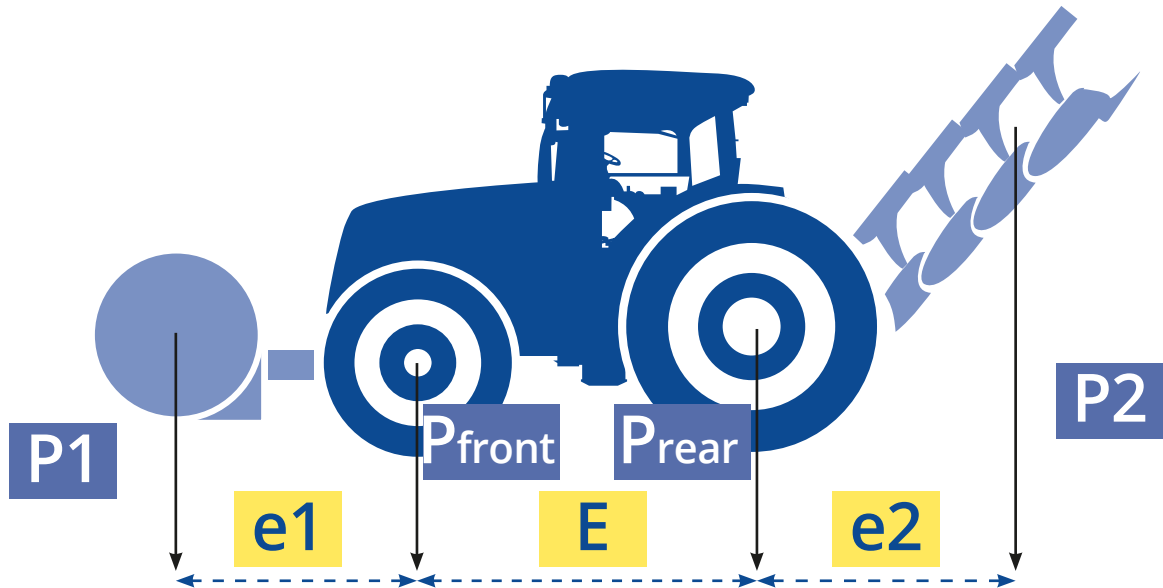

	Front axle	Rear axle
Tractor (lbs)	P front	P rear
Equipment or mass (lbs)	P 1	P 2
Carry forward equipment or mass (lbs)	$P 1 \times (e1/E)$	$P 2 \times (e2/E)$
Total load per axle (lbs)	$P \text{ front} + P 1 + [P 1 \times (e1/E)]$	$P \text{ rear} + P 2 + [P 2 \times (e2/E)]$
Number of tires	N front	N rear
Load per tire (lbs)	Total front load / N front	Total rear load / N rear

Example :

Information required	Front	Rear
Tractor (lbs)	6,600	11,000
Equipment or mass (lbs)	2,200	4,400
Distance (feet)	$E = 118 \text{ in} - e1 = 59 \text{ in} - e2 = 98 \text{ in}$	

Calculate	Front axle	Rear axle
Tractor (lbs)	6,600	11,000
Equipment or mass (lbs)	2,200	4,400
Carry forward equipment or mass (lbs)	$2,200 \times (59/118) = 1,100$	$4,400 \times (98/118) = 3,654$
Total load per axle (lbs)	$6,600 + 2,200 + 1,100 = \mathbf{9,900}$	$11,000 + 4,400 + 3,654 = \mathbf{19,054}$
Number of tires	2	2
Load per tire (lbs)	$9,900 / 2 = \mathbf{4,950}$	$19,054 / 2 = \mathbf{9,527}$

For dual or triple assembly, see following page.

LOAD-BALANCING CALCULATION

DUAL OR TRIPLE FITMENT

1 - Divide the axle load by 4 if dual (or by 6 if triple)

2 - Then divide the result by 0.88 if dual (or by 0.82 if triple)

* For load calculation, see previous page.

EXAMPLE OF A CALCULATION FOR A DUAL FITTING

- Tractor with 650/85R38 MICHELIN MACHXBIB 173A8/173B TL
- Established axle load = 30,800 lbs
- Use = stubble plowing

a) If the Dual line at the desired speed is in the load/pressure table:

- divide the total load by 4 (4 tires)
- use the Dual line to determine pressure

b) If the Dual line at the desired speed is not in the load/pressure table:

- divide the total load by 4
- divide the result by 0.88
- use the desired speed line on the load/pressure table

Example for a total load of 30,800 lbs on a dual fitted rear axle:

$$[30,800 / 4] / 0.88 = 8,750 \text{ lbs}$$



i.e. recommended pressure of 12 psi for a speed of 25 mph



Note: for triple fitting, divide the load by 6, then divide by 0.82 to obtain the load in question.

SOME EXAMPLES OF LOADS LBS PER CUBIC FOOT

Material	Approximate Load in lbs
Straw	6 to 9
Hay	9 to 12
Cereals (wheat, corn, soybeans)	38 to 50
Beets	56
Potatoes	37
Liquid fertilizer	81 to 100
Manure	56
Topsoil	75 to 94
Dry sand	94
Wet sand	120

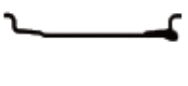
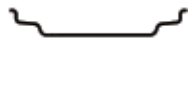
RIM AND O-RING REFERENCES

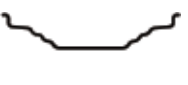
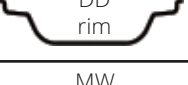
Type of rim	Dimensions	F mm	H mm	P mm
Drop center rim standard 5° 	3.00 D	76	16.5	18
	3.50 D	89	18	
	4.00 E	101.5	20	
	4.50 E	114.5	20	
	5.00 E	127	16	
	5.375 I	136.5	16	
	5.50 F	140	22.5	
	6.00 F	152.5	22.5	
	6.50 F	165	22.5	
Drop center rim 2 5° drop centers 	9	228.5	25.5	27
	11	279.5		31.5
	12	305		
	13	330		
	14	355.5		
	16	406.4	25.4	
Drop center rim 2 15° drop centers 	10.50	266.7	12.7	44
	11.75	298.5		
	12.25	311		
	13.00	330		
	14.00	355.5		
	15.00	381		
	16.00	406.5		
	AG 16.00	406.5		
	17.00	432		
	18.00	457		
	20.00	508		
	AG 20.00	508		
	AG 24.00	609.5		
AG 28.00	711			
SDC rim 	11	279.5	25.5	38.1
	12	305		
	13	330		
	36.0 TH	914.4		
	36.00 VA	914.4		
W rim 	W 6	152.4	22.2	23.8
	W 7	177.8		
	W 8	203.2		
	W 8L	203.2		
	W 9	228.6	25.4	27
	W 10	254		
	W 10L	254		
	W 11	279.4		
	W 12	304.8	25.4	33
	W 13	330.2		
	W 14L	355.6		
	W 15L	381		
	W 16L	406.4		
	W 18L	457.2		

Type of rim	Dimensions	F mm	H mm	P mm
DW rim  DW-8 rims replace the DW-A rims they are identical and fully interchangeable	DW 10	254	25.4	27
	DW 11	279.4		
	DW 12	304.8		
	DW 13	330.2		36.5
	DW 14L	355.6		
	DW 15L	381		
	DW 16L	406.4		
	DW 10	431.8		50.8
	DW 18L	457.2		
	DW 20B	508		
	DW 21B	533.4		
	DW 23B	584.2		
	DW 24B	609.5		
	DW 25B	635		
	DW 27B	686		
	DW 28B	711		
	DW 30B	762		
TW rim 	TW 13	330	25.5	27
	TW 14L	355.5		36.5
	TW 15L	381		
	TW 16L	406.5		
	TW 18L	457		50.8
	TW 20B	508		
	TW 21B	533.5		
	TW 23B	584		
	TW 24B	609.5		
	TW 25B	635		
TW 27B	686			
TW 28B	711			
TW 30B	762			
DD rim 	DD 15L	381	41	36.5
	DD 16L	406.5		50.5
	DD 18L	457		
MW rim 	MW 20	508	29	50.8
	MW 23	584		
	MW 25	635		
DH27B rim 	DH 27B	686	29	54

When the DW is allowed, the TW rim is automatically allowed too (ERTO).

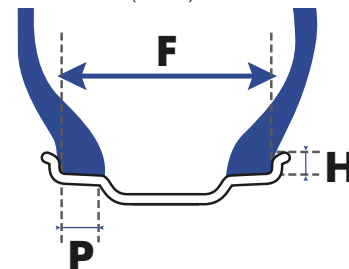

F = interior width
H = height of flange (+/- 1 mm)
P = width of seat





O-RINGS FOR SDC RIMS

Reference	Name	Comments	Serial No.
R 1681	O-ring OR 6.6 - 20	For 20" rim in 3 parts	553215
R 1438	O-ring OR 2 - 25	For 25" rim in 3 parts	553201
R 2052	O-ring OR 2 - 32	For 32" rim in 3 parts	553055

For O-rings, the name consists of:

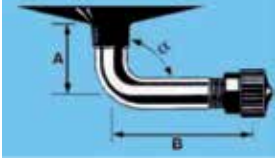
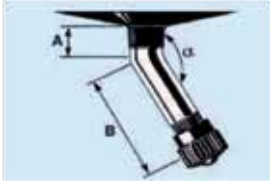
- OR for O-ring
- The first digit describes the section of the ring joint; it is a whole number expressed eighths of an inch (e.g. 2 = 2/8").
- The second digit describes the diameter of the seat; it is a whole number expressed in inches.

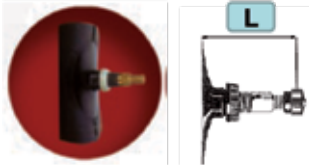
VALVE CHARACTERISTICS

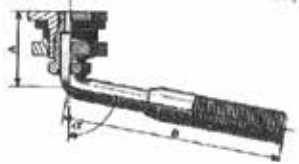
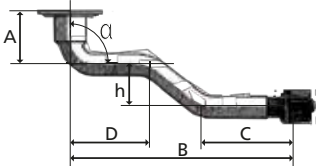
INNER TUBE VALVES		
Valve reference	Photo	Characteristics
10 SC29		A = 15 mm B = 29 mm $\alpha = 90^\circ$ \varnothing = valve hole = 10 mm
10 SCH40		A = 13 mm B = 27 mm $\alpha = 150^\circ$ \varnothing = valve hole = 10.2 mm
TR13 (ETRO = V2-01-1)		L = 35 mm \varnothing = valve hole = 11.5 mm
TR15 (ETRO = V2-01-2)		L = 35 mm \varnothing = valve hole = 16 mm
TR218A (ETRO = V7-01-1) Air / water valves		L = 47,5 mm \varnothing = valve hole = 15.7 mm
1964		L = 40 mm \varnothing = valve hole = 9.7 mm
1837 Correspondences: • TRA = TRJ650 • ETRO = V5-04-1		A = 27 mm B = 29 mm $\alpha = 80^\circ$ \varnothing = valve hole = 20.5 mm
582 (ETRTO = V3.06.5)		A = 20,5 mm / B = 131 mm C = 49 mm / D = 62,5 mm $\alpha = 90^\circ$ / h = 17 mm
1123 (ETRTO = V3.06.8)		A = 24,5 mm / B = 126,5 mm C = 50,5 mm / D = 61,5 mm $\alpha = 94^\circ$ / h = 17 mm

continued on next page...

VALVE CHARACTERISTICS

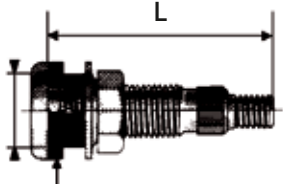
TUBELESS VALVES		
Valve reference	Photo	Characteristics
TR618A (ETRO = V5-01-1) Air / water valve		L = 47.5 mm Ø = valve hole = 15.7 mm

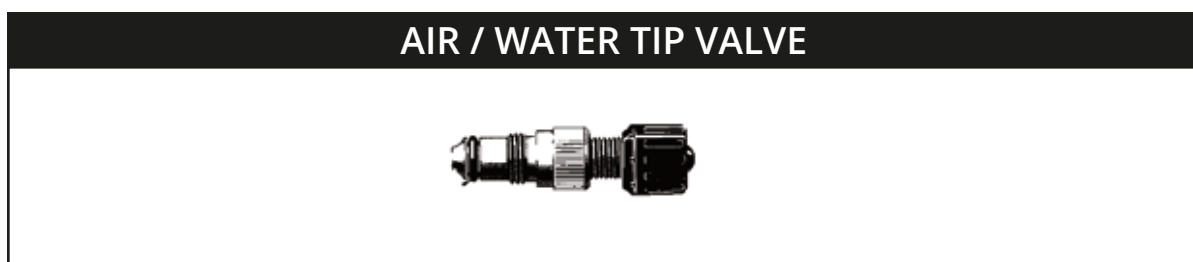

TUBES

RIM	TIRE SIZE	VALVE CODE	MSPN
16	4.50-16	TR 13	14106
	5.50 - 16	TR 15	84201
	6.00 - 16	TR 15	84201
	6.00 - 16	TR 218A	43906
	6.50 - 16	TR 218A	43906
	7.50-16	TR 218A	36119
	10.00-16	TR 218A	78371
	10.50 - 16	TR218A	3551
	11.00-16	TR 218A	78371
	260/70 - 16	TR 218A	39701
	280/70 - 16	TR 218A	39701
	275/65 - 16	TR218A	3551
	320/65 - 16	TR218A	3551
	18	7.50 - 18	TR 218A
10.5/80 - 18		TR 218A	39082
12.0 - 18		TR 218A	11037
12.0 - 18		TR 15	73382
12.5 - 18		TR 218A	11037
280/80 - 18		TR 218A	39082
335/80 - 18		TR 218A	11037
340/80 - 18		TR 218A	11037
260/70 - 18		TR 218A	39082
280/70 - 18		TR 218A	39082
320/65 - 18		TR 15	73382
320/65 - 18		TR 218A	11037
335/65 - 18		TR 15	73382
340/65 - 18		TR 15	73382
340/65 - 18	TR 218A	11037	
20	7.50 - 20	TR 218A	23393
	9.5 - 20	TR 218A	32538
	14.9 - 20	TR 218A	88153
	340/75 - 20	TR 218A	88153
	375/75 - 20	TR 218A	88153
	380/75 - 20	TR 218A	88153
	260/70 - 20	TR 218A	32538
	280/70 - 20	TR 218A	32538
	360/70 - 20	TR 218A	88153
	400/70 - 20	TR 218A	88153
24	8.3 - 24	TR 218A	71115
	9.5 - 24	TR 218A	71115
	11.2 - 24	TR 218A	18915
	12.4 - 24	TR 218A	18915
	13.6 - 24	TR 218A	7878
	14.5 - 24	TR 218A	7878
	14.9 - 24	TR 218A	39226
	250/85 - 24	TR 218A	71115
	280/85 - 24	TR 218A	18915

RIM	TIRE SIZE	VALVE CODE	MSPN	
24	320/85 - 24	TR 218A	18915	
	340/85 - 24	TR 218A	7878	
	380/85 - 24	TR 218A	39226	
	440/80 - 24	TR 218A	23912	
	320/70 - 24	TR 218A	18915	
	360/70 - 24	TR 218A	18915	
	380/70 - 24	TR 218A	7878	
	400/70 - 24	TR 218A	39226	
	420/70 - 24	TR 218A	N/A	
	440/70 - 24	TR 218A	23912	
	445/70 - 24	TR 218A	23912	
	460/70 - 24	TR 218A	23912	
	480/70 - 24	TR 218A	23912	
	500/70 - 24	TR 218A	23912	
	420/65 - 24	TR 218A	7878	
	440/65 - 24	TR 218A	39226	
	480/65 - 24	TR 218A	23912	
	540/65 - 24	TR 218A	23912	
	26	18.4 - 26	TR218A	72202
		23.1 - 26	TR218A	15800
480/80 - 26		TR218A	72202	
VF520/80 - 26		TR218A	72202	
620/75 - 26		TR218A	15800	
520/70 - 26		TR218A	72202	
580/70 - 26		TR218A	15800	
580/70 - 26		TR218A	72202	
620/70 - 26		TR218A	15800	
620/70 - 26		TR218A	40549	
VF620/70 - 26		TR218A	72202	
28		11.2 - 28	TR218A	18809
	12.4 - 28	TR218A	32751	
	13.6 - 28	TR218A	51574	
	14.9 - 28	TR218A	66800	
	16.9 - 28	TR218A	69205	
	19.5LR - 28	TR218A	69205	
	280/85 - 28	TR218A	18809	
	320/85 - 28	TR218A	32751	
	340/85 - 28	TR218A	51574	
	380/85 - 28	TR218A	66800	
	360/70 - 28	TR218A	32751	
	380/70 - 28	TR218A	51574	
	420/70 - 28	TR218A	66800	
	480/70 - 28	TR218A	69205	
	600/70 - 28	TR218A	40549	
	420/65 - 28	TR218A	51574	
440/65 - 28	TR218A	66800		

continued on next page...

RIM	TIRE SIZE	VALVE CODE	MSPN
28	540/65 - 28	TR218A	69205
	600/65 - 28	TR218A	40549
	VF480/60 - 28	TR218A	66800
	VF520/60 - 28	TR218A	69205
	VF600/60 - 28	TR218A	69205
30	14.9 - 30	TR218A	961
	16.9 - 30	TR218A	87572
	18.4 - 30	TR218A	61754
	23.1 - 30	TR218A	14591
	380/85 - 30	TR218A	961
	420/85 - 30	TR218A	87572
	460/85 - 30	TR218A	61754
	620/75 - 30	TR218A	14591
	420/70 - 30	TR218A	961
	480/70 - 30	TR218A	87572
	520/70 - 30	TR218A	61754
	600/70 - 30	TR218A	14591
	540/65 - 30	TR218A	87572
	VF600/60 - 30	TR218A	61754
32	24.5 - 32	TR218A	2354
	30.5 - 32	TR218A	2354
	650/85 - 32	TR218A	2354
	680/85 - 32	TR218A	2354
	IF680/85 - 32	TR218A	2354
	800/65 - 32	TR218A	2354
34	900/60 - 32	TR218A	2354
	16.9 - 34	TR218A	31693
	18.4 - 34	TR218A	47263
	420/85 - 34	TR218A	31693
	460/85 - 34	TR218A	47263
	480/70 - 34	TR218A	31693
	540/70 - 34	TR218A	47263
	540/65 - 34	TR218A	31693
	600/65 - 34	TR218A	47263
	IF650/65 - 34	TR218A	47263
	600/60 - 34	TR218A	47263
	VF600/60 - 34	TR218A	47263
	IF650/60 - 34	TR218A	47263
36	11.2 - 36	TR218A	14677
	12.4 - 36	TR218A	14677
	270/95 - 36	TR218A	14677
	320/85 - 36	TR218A	14677
38	11.2 - 38	TR218A	14677
	12.4 - 38	TR218A	14677
	13.6 - 38	TR218A	73399
	14.9 - 38	TR218A	11166
	15.5 - 38	TR218A	14475

RIM	TIRE SIZE	VALVE CODE	MSPN	
38	16.9 - 38	TR218A	11166	
	18.4 - 38	TR218A	85982	
	20.8 - 38	TR218A	5817	
	270/95 - 38	TR218A	14677	
	320/85 - 38	TR218A	14677	
	340/85 - 38	TR218A	73399	
	420/85 - 38	TR218A	11166	
	460/85 - 38	TR218A	85982	
	520/85 - 38	TR218A	5817	
	650/85 - 38	TR218A	66662	
	IF650/85 - 38	TR218A	66662	
	IF710/85 - 38	TR218A	66662	
	650/75 - 38	TR218A	66662	
	480/70 - 38	TR218A	11166	
	520/70 - 38	TR218A	85982	
	580/70 - 38	TR218A	5817	
	620/70 - 38	TR218A	5817	
	710/70 - 38	TR218A	66662	
	540/65 - 38	TR218A	85982	
	42	600/65 - 38	TR218A	5817
650/65 - 38		TR218A	5817	
VF710/60 - 38		TR218A	5817	
VF600/60 - 38		TR218A	85982	
16.9 - 42		TR218A	27984	
18.4 - 42		TR218A	27984	
20.8 - 42		TR218A	90038	
520/85 - 42		TR218A	90038	
620/70 - 42		TR218A	90038	
IF710/70 - 42		TR218A	90038	
46	650/65 - 42	TR218A	90038	
	VF710/60 - 42	TR218A	90038	
	12.4 - 46	TR218A	96272	
	14.9 - 46	TR218A	96272	
	18.4 - 46	TR218A	19186	
	20.8 - 46	TR218A	19186	
	380/90 - 46	TR218A	96272	
	420/85 - 46	TR218A	96272	
	520/85 - 46	TR218A	19186	
	420/80 - 46	TR218A	96272	
	480/80 - 46	TR218A	19186	
	48	9.5 - 48	TR218A	96272
		11.2 - 48	TR218A	96272
52	12.4 - 52	TR218A	97549	
	300/95 - 52	TR218A	97549	
54	11.2 - 54	TR218A	97549	
	270/95 - 54	TR218A	97549	
	320/90 - 54	TR218A	97549	

MOUNTING / DISMOUNTING

There are risks in dismounting and mounting tires, so procedures must be carried out by trained and qualified staff, using appropriate tools and methods.

Never give this task to an unaccompanied apprentice; if several people are involved in the task with Large tires, ensure **at least one of the team** remains the same **for all parts of the procedure**.

The compressed air supply must be equipped with a pressure limit switch.

Failure to follow these instructions can lead to incorrect mounting of the tire on the rim, resulting in tire blow-outs and potentially serious or fatal injuries.

DISMOUNTING A TIRE FROM THE RIM

1. **Never try to unseat the rim and/or beads on an inflated tire.**
2. **The internal mechanism of the valve must be removed.**
 - make sure that the tire is fully deflated before dismounting it,
 - do not use tools that may damage the sidewalls or the tire beads,
 - unseat the beads using the removal slots (if present),
 - to facilitate removal and protect the beads, particularly in case of a puncture, lubricate the rim seats and tire beads,
 - if the rim shows obvious signs of damage then the tire must be deflated before dismantling the assembly.

PREPARATION FOR MOUNTING

1. **Before mounting, ensure that the rim, tire and inner tube are compatible, and check that:**
 - the tire is compatible with the vehicle or machine
 - the diameter of the rim seat corresponds to the seat of the tire to be fitted
 - (e.g.: 18.4 R 30 tire Rim: DW16L x 30),
 - the tire may be fitted to this rim (see characteristics in the Manufacturer's Documentation).

-  **Never fit 15" tires to rims with 15.3" seats.**
- Never fit 16" tires to rims with 16.1" or 16.5" seats.**

2. Before mounting a tire to a rim that has already been used:

- ensure the rim is clean and in perfect condition (showing no damage),
- if not, then thoroughly clean the rim using a wire brush.



Never fit a tire to a rim with cracks, significant distortion, signs of fracture, evidence of welded repairs, etc.

3. If the tire has been used, carefully examine its interior and exterior for possible damage.

- if it shows signs of damage or deterioration that are deemed irreparable by a specialist, discard the tire.

4. For inner tube mountings, always use a new inner tube suitable for the tire dimensions (inner tube markings showing compatible tire sizes).



Do not mount the inner tube to a damaged or repaired rim, or to a rim with a finish incompatible with a tube.

Fit a new Tubeless valve whenever you replace a Tubeless tire.

5. Always use tools that have no sharp edges, are in good condition and are suitable for the tires and rims (bead unseating, levers, machines...).

For wide or large tires, we recommend using a bead pusher or bead unseating tool (with appropriate mechanical assistance) to fit the second bead.

Before mounting, lubricate the rim seats and tire beads. Apply a thin layer of lubricant to the surfaces shown on the diagram below; on the outside of the beads the lubricant should reach 2 inches above the rim flange.

Only use products designed for this purpose that will not degrade the tire (do not for example use hydrocarbon, silicon or antifreeze-based products).

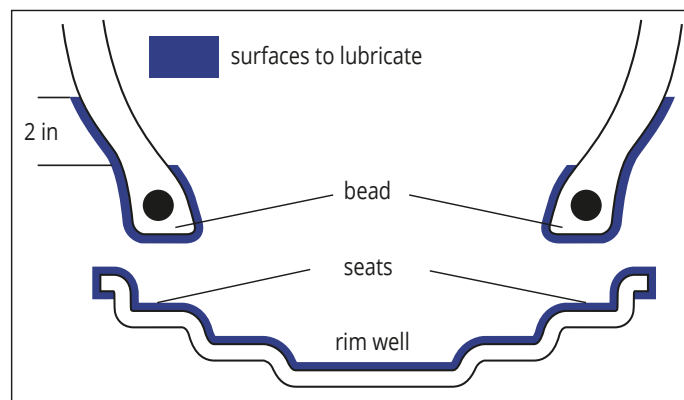

MOUNTING / DISMOUNTING

VERTICAL MOUNTING OF TIRE TO WHEEL

1. Position the valve or valve hole at the bottom.
2. If there is a diagram of the valve on the sidewall of the tire, position the diagram as close as possible to the rim valve hole or valve.
3. Slip the tire onto the rim so that the first tire bead is positioned against the rim flange. Remember to rotate in the direction indicated by the arrow on the tire (if present).
4. Using a suitable lever to apply pressure approximately every 10 cm:
 - push the first bead over the rim flange.

Once the first bead is over:

- position the lightly inflated inner tube inside the tire (for inner tube mountings),
- fix the valve by partially tightening the nut.

For the second bead:

- lever it over the rim flange, finishing at the valve.

5. Centering the tire, mounting the beads

- lower the jack slightly to optimise tire centering,
- pull out the valve's inner mechanism,
- slowly and partially inflate for optimal bead positioning,
- check the beads are not pinching the inner tube,
- inflate to 2.5 bar but no more, to ensure that the beads are properly positioned.

INFLATION AND BEAD POSITIONING

Apply safety rules:

- system to support the tire assembly (safety cage),
- safety goggles,
- safety footwear,
- ear defenders.

If there is no safety bar or cage, the operator should be as far as possible from the tire and the rim.

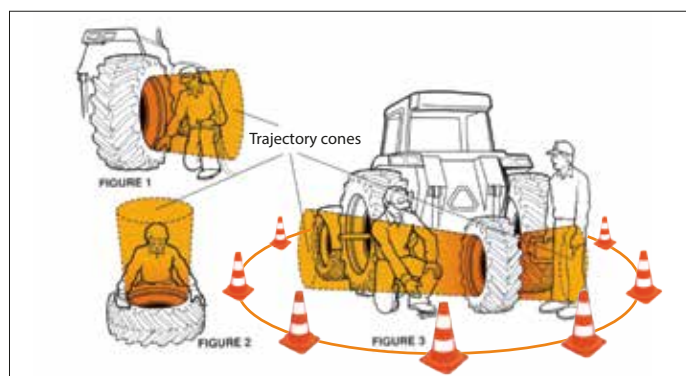

Never stand within the trajectory cones (Figures 1, 2 and 3), to avoid any risk of physical injury in the event of an incident.

For optimum safety conditions use a fully functional inflation gun connected to the valve by an air-hose extension of at least 10 feet, with a clip fitted to the valve and a calibrated pressure-gauge (never lock the trigger).

When positioning the beads take particular care to ensure they are correctly located and centred in relation to the rim flanges and inflate to 35 psi, but no more.

If the beads are not correctly positioned:

- deflate, re-lubricate and inflate to 35 psi
- repeat the operation as often as necessary until the beads are correctly positioned.

To fit and position the beads to the rim seats

INFLATE TO 35 PSI WITHOUT EXCEEDING THIS PRESSURE

The pictogram opposite shows the maximum inflation pressure which must not be exceeded when positioning the beads.

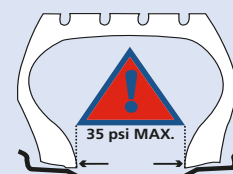

Once all the preceding operations have been properly executed,

- replace the valve's inner mechanism,
- tighten the nut on the valve by hand,
- inflate to the determined service pressure, according to the load levels stated in the manufacturer's documentation, or to storage pressure,
- tighten the valve cap after any inflation or pressure check, as this alone ensures that the valve remains clean and sealed.

If mounting the tire horizontally on the ground (not recommended because it is impossible to see if the lower bead is in place), take the following additional precautions:

- Initially, do not go above a maximum pressure of 10 psi (to establish the seal),
- Lift the tire-rim assembly, place it in a safety cage or position the upper part against a wall, never against a door or light partition wall,
- Follow the instructions for inflation and positioning the beads.

Note: All radial tires to be used at low pressures must be fitted to high quality rims.

MOUNTING / DISMOUNTING

BEGINNING OPERATIONS / RECOMMENDATIONS

- When transporting machinery (by road, rail or ship), we recommend inflating tires to 1.8 bar (26 psi) to avoid damage due to certain stowage systems.
- When starting the machinery, pressures must be determined and adjusted according to the load on the tires and actual conditions of use.

USER INSTRUCTIONS

Correct Pressure

=

- ✓ Comfort
- ✓ Grip
- ✓ Soil Protection
- ✓ Service Life of Tires
- ✓ Optimal Productivity of the Machine

BALLASTING

Ballasting tires with liquids:

In specific cases, to increase adhesion weight or lower the machine's centre of gravity, both Tubeless and Tube Type tires can be ballasted with liquid.

Agricultural valves are "air and water". This means tires can be filled with liquid (water + anti-freeze) to a 75% maximum (diagram 1).

In winter, temperatures may fall below freezing and at 0°C the use of a Glycol based anti-freeze product is required.

Fill the inner tube or Tubeless tire with liquid up to the level of the valve (valve at highest point), while releasing the air (diagram 2).

Inflation and pressure are adjusted using air.

As the volume of air providing pressure is low (around 25% volume), regular pressure checks are essential – we recommend monthly.

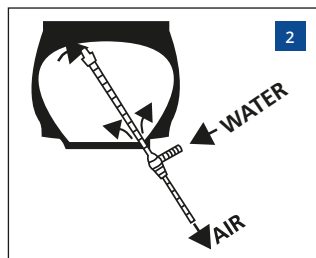
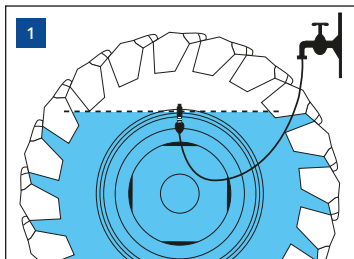

Tubeless liquid ballasting:

- Assemble and position the tire; see "Inflation and bead positioning" on previous page,
- Deflate the tire to a low pressure (roughly 0.5 bar)
- Position the valve at the highest point,
- Start to fill the tire with liquid (water + anti-freeze), to a maximum of 75% while releasing the air (diagram 2),
- Finish inflating with air and adjust the pressure.

STORAGE

To be correctly stored, tires must be kept in clean conditions in dry and ventilated premises, away from direct sunlight. They must be kept away from:

- any source of ozone (electric motor, transformer, arc welding station etc...),
- any chemicals, solvents and hydrocarbons that may affect the nature of the rubber.
- any objects that could pierce the rubber (sharp or pointed metal objects etc.).
- Keep away from flames or hot objects.

During storage periods, agricultural tires and inner tubes must be stored to avoid damage due to tension or compression, and so assembled and inflated if stacked; de-ballast vehicle-mounted tires as much as possible and over-inflate by 7 psi in relation to in-use pressures.



Never store bare tires or whole off-vehicle wheels in direct contact with the ground for long periods.

- The use of protective gloves is recommended when handling tires.

Never heat, weld or solder a rim or wheel with a tire fitted.

Always remove the tire from the rim before any intervention.

Always use the Michelin inflation table to decide on the correct pressure for the intended use

Under-inflation causes the carcass to become excessively misshapen and renders the tire unusable.

Over-inflation reduces the surface area in contact with the ground, causing a loss of grip and making the tire more sensitive to impacts and cuts.

If loads are lower than those shown in our load pressure tables, never go below the minimum tire pressure shown.

MICHELIN® AGRICULTURE AND COMPACT EQUIPMENT TIRES

TECHNICAL DATA BOOK | 2023



 TO FIND OUT MORE
US: business.michelinman.com/agriculture
CA: business.michelin.ca

 FIND US ON FACEBOOK
@MichelinAgri

 CONTACT US BY EMAIL
US: business.michelinman.com/contact-us
CA: business.michelin.ca/contact

 CONTACT US BY TELEPHONE
US: 1-888-622-2306
CA: 1-888-622-2306



Michelin North America Inc., One Parkway South, Greenville, SC 29615
Michelin North America (Canada) Inc., 2500 Daniel Johnson Blvd., Suite 500, Laval (QC) H7T 2P6

Michelin tires and tubes are subject to a continuous development program. Michelin North America, Inc. reserves the right to change product specifications at any time, without notice or obligation.

Copyright © 2022 Michelin North America, Inc. All rights reserved. | © 2022 MNA(C). All rights reserved.

An Equal Opportunity Employer | (BWA 10/22) | MUT21000

