

MICHELIN

TRACK CONNECT

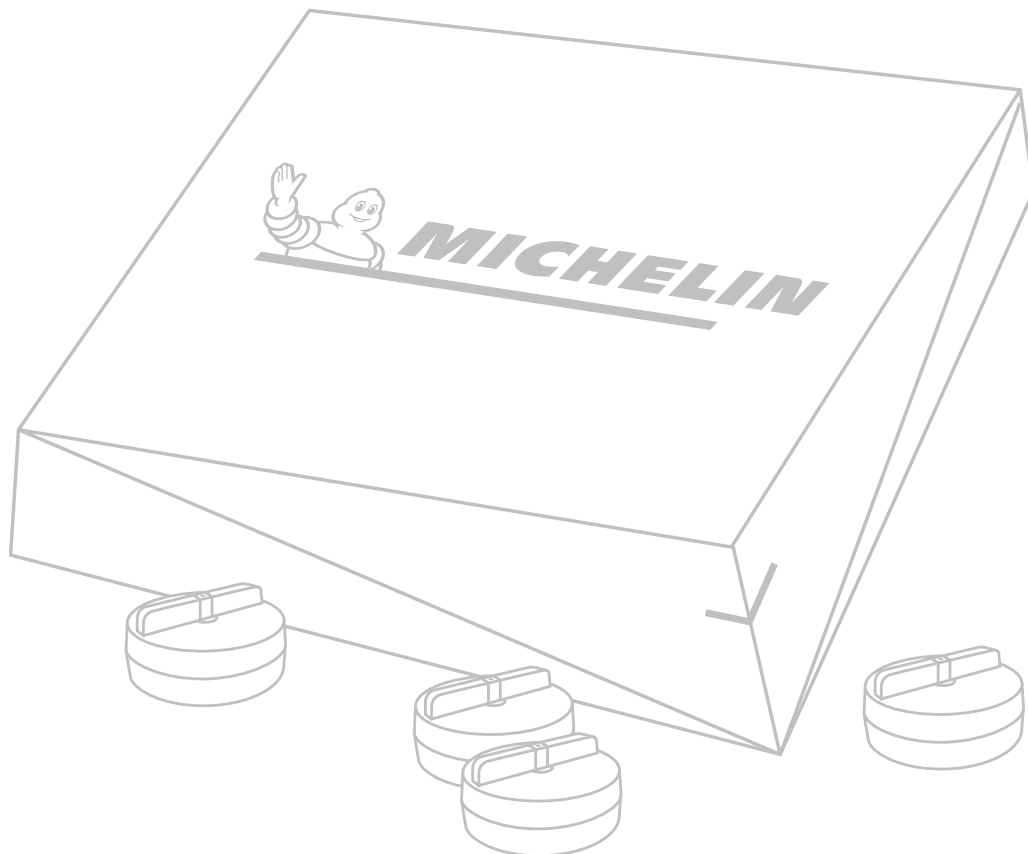

INSTALLATION GUIDE

GUIDE D'INSTALLATION
| MONTAGEANLEITUNG | GUÍA DE INSTALACIÓN
| GUIDA ALL'INSTALLAZIONE | 安裝指南

Version 4 - 2021
Version 4 - 2021
Version 4 - 2021
Versión 4 - 2021
Versão 4 - 2021
Versie 4 - 2021
2021年第4版



The **MICHELIN TRACK CONNECT** kit must be installed and configured by an automotive professional.

Le kit **MICHELIN TRACK CONNECT** doit être installé et paramétré par un professionnel de l'automobile.

Der **MICHELIN TRACK CONNECT**-Set muss von einem Kfz-Fachmann installiert und parametrieret werden.

El kit **MICHELIN TRACK CONNECT** debe ser instalado y configurado por un profesional del automóvil.

Il kit **MICHELIN TRACK CONNECT** deve essere installato e configurato da un professionista del settore automobilistico.

O kit **MICHELIN TRACK CONNECT** deve ser instalado e configurado por um profissional do automóvel.

De **MICHELIN TRACK CONNECT** kit moet worden geïnstalleerd en opgezet door een autoprofessional.

米其林**TRACK CONNECT**套组应由专业人士进行安装和调试。



Scan the QR code for installation and configuration information.



Le istruzioni di installazione e di configurazione sono reperibili scansionando il QR Code.



Retrouver toutes les instructions d'installation et de paramétrage en flashant ce QR Code.

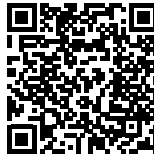

Escaneie este código QR para obter todas as instruções de instalação e configuração.



Scannen Sie diesen QR-Code; er enthält alle Anweisungen für die Installation und Parametrierung.



Zoek alle installatie- en instellingsinstructies op door deze QR-code te laten knippen.



Consulte las instrucciones de instalación y configuración escaneando este código QR.



请扫描QR二维码以获取安装说明以及参数设置。

CONTENTS

SOMMAIRE / INHALT / ÍNDICE / SOMMARIO / SUMÁRIO/ SAMENVATTING / 目录

1 - Fit the sensor in the tyre and mount the tyre on the rim P | 6

- | Installer le capteur dans le pneumatique et monter le pneumatique sur la jante
- | Den Sensor im Reifen installieren und den Reifen auf die Felge montieren
- | Instalar el sensor en el neumático y montar el neumático en la llanta
- | Installare il sensore nel pneumatico e montare il pneumatico sul cerchione
- | Instalar o sensor no pneu e montar o pneu na jante
- | Monteer de sensor in de band en monteer de band op de velg
- | 在轮胎上安装传感器，并将轮胎安装在轮毂上

2 - Recommended tyre fitting (with a machine) P | 8

- | Montage recommandé du pneu (à la machine)
- | Empfohlene Montage des Reifens (mit der Maschine)
- | Montaje recomendado del neumático (a máquina)
- | Montaggio consigliato del pneumatico (montaggio a macchina)
- | Montagem recomendada do pneu (na máquina)
- | Aanbevolen montage van banden (machinaal)
- | 轮胎组装推荐步骤（使用工具）

3 - Installing the tyre on the vehicle P | 12

- | Installation du pneu sur le véhicule
- | Installation des Reifens am Fahrzeug
- | Instalación del neumático en el vehículo
- | Installazione del pneumatico sul veicolo
- | Instalação do pneu no veículo
- | Installatie van de band op het voertuig
- | 将轮胎安装回车上

4 - Installing and configuring the **MICHELIN TRACK CONNECT** app P | 14

- | Installation et configuration de l'application **MICHELIN TRACK CONNECT**
- | Installation und Konfiguration der **MICHELIN TRACK CONNECT**-Applikation
- | Instalación y configuración de la aplicación **MICHELIN TRACK CONNECT**
- | Installazione e configurazione dell'applicazione **MICHELIN TRACK CONNECT**
- | Instalação e configuração do aplicativo **MICHELIN TRACK CONNECT**
- | Installatie en configuratie van de **MICHELIN TRACK CONNECT** toepassing
- | 安装并设置米其林**TRACK CONNECT**应用程序

5 - Installing and pairing the receiver in the vehicle P | 20

- | Installation et appairage du récepteur dans le véhicule
- | Installation und Pairing des Empfängers im Fahrzeug
- | Instalación y conexión del receptor en el vehículo
- | Installazione e accoppiamento del ricevitore nel veicolo
- | Instalação e pareamento do receptor no veículo
- | Installatie en koppeling van de ontvanger in het voertuig
- | 在车中安装并匹配接收器

6 - Pairing the sensors with the **MICHELIN TRACK CONNECT** app P | 24

- | Appairage des capteurs avec l'application **MICHELIN TRACK CONNECT**
- | Pairing der Sensoren mit der **MICHELIN TRACK CONNECT**-Applikation
- | Vinculación de los sensores con la aplicación **MICHELIN TRACK CONNECT**
- | Accoppiamento dei sensori con l'applicazione **MICHELIN TRACK CONNECT**
- | Pareamento dos sensores com o aplicativo **MICHELIN TRACK CONNECT**
- | Koppeling van sensoren met de **MICHELIN TRACK CONNECT** toepassing
- | 将传感器与米其林**TRACK CONNECT**应用程序配对



RECEIVER: Model: MTC-V1

- | RÉCEPTEUR : Modèle : MTC-V1
- | EMPFÄNGER: Modell: MTC-V1
- | RECEPTOR: Modelo: MTC-V1
- | RICEVITORE: Modello: MTC-V1
- | RECEPTOR: Modelo: MTC-V1
- | ONTVANGER: Model: MTC-V1
- | 接收器：型号：MTC-V1

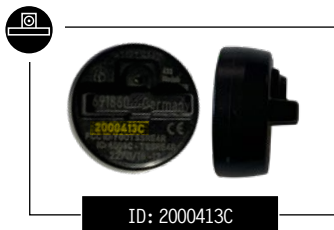

Make a note of each sensor's ID number

⊖ ID: 2
 Ⓜ ID: 5
 Example: 51425ED4

⊖ ID: 2
 Ⓜ ID: 5
 Example: 51425ED3

⊖ ID: 2
 Ⓜ ID: 5
 Example: 51425ED6

⊖ ID: 2
 Ⓜ ID: 5
 Example: 51425ED5

- | Veuillez noter l'ID inscrit sur chaque capteur
- | Bitte die auf jedem Sensor markierte Kennung notieren
- | Anote el ID inscrito en cada sensor
- | Prendere nota dell'ID presente su ogni sensore
- | Observe o ID inscrito em cada sensor
- | Let op de ID die op elke sensor wordt geschreven
- | 请记录每个传感器的注册识别号

1

FIT THE SENSOR IN THE TYRE AND MOUNT THE TYRE ON THE RIM

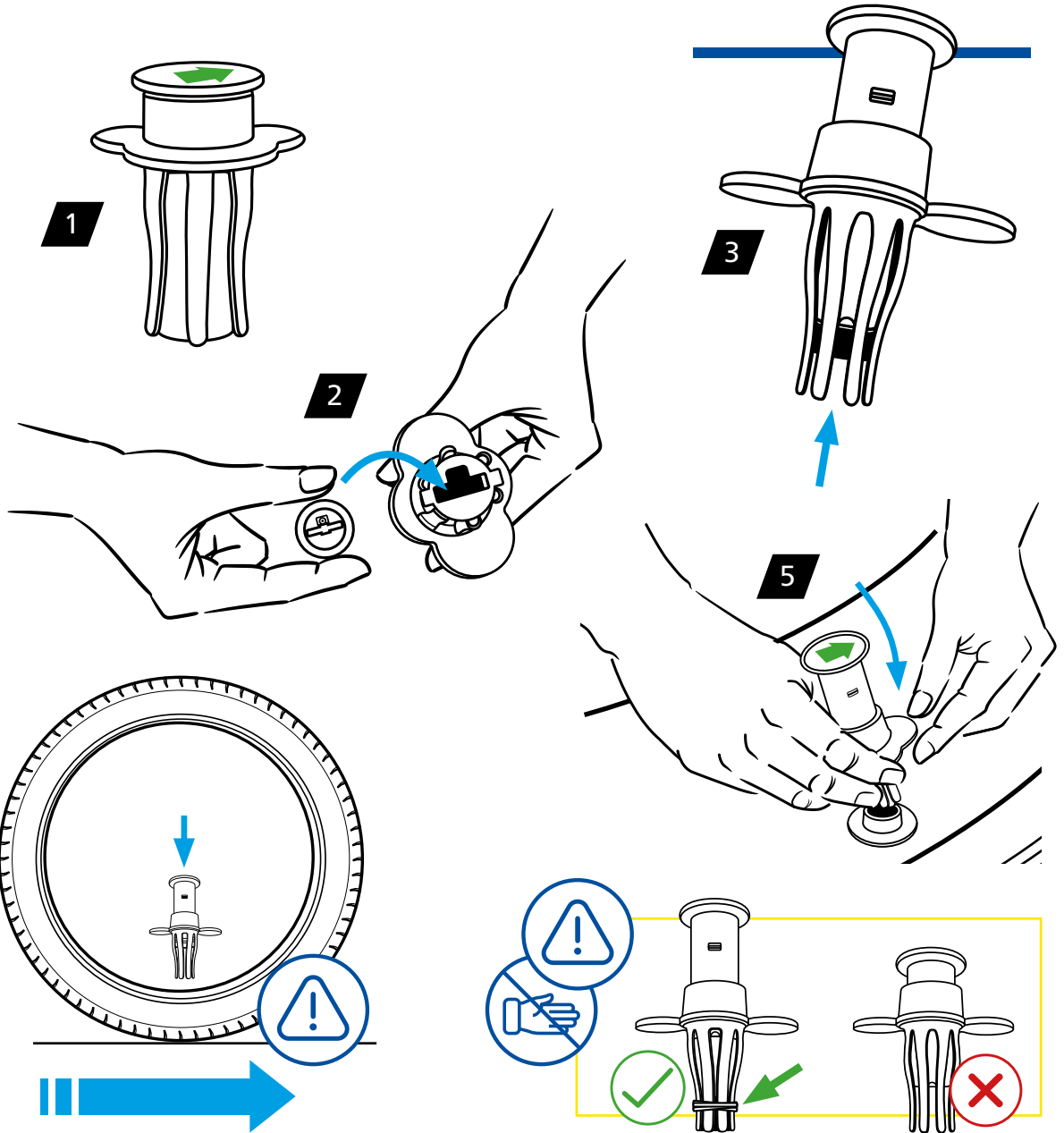

- INSTALLER LE CAPTEUR DANS LE PNEUMATIQUE ET MONTER LE PNEUMATIQUE SUR LA JANTE
- DEN SENSOR IM REIFEN INSTALLIEREN UND DEN REIFEN AUF DIE FELGE MONTIEREN
- INSTALAR EL SENSOR EN EL NEUMÁTICO Y MONTAR EL NEUMÁTICO EN LA LLANTA
- INSTALLARE IL SENSORE NEL PNEUMATICO E MONTARE IL PNEUMATICO SUL CERCHIONE
- INSTALAR O SENSOR NO PNEU E MONTAR O PNEU NA JANTE
- MONTEER DE SENSOR IN DE BAND EN MONTEER DE BAND OP DE VELG
- 在轮胎上安装传感器，并将轮胎安装在轮毂上

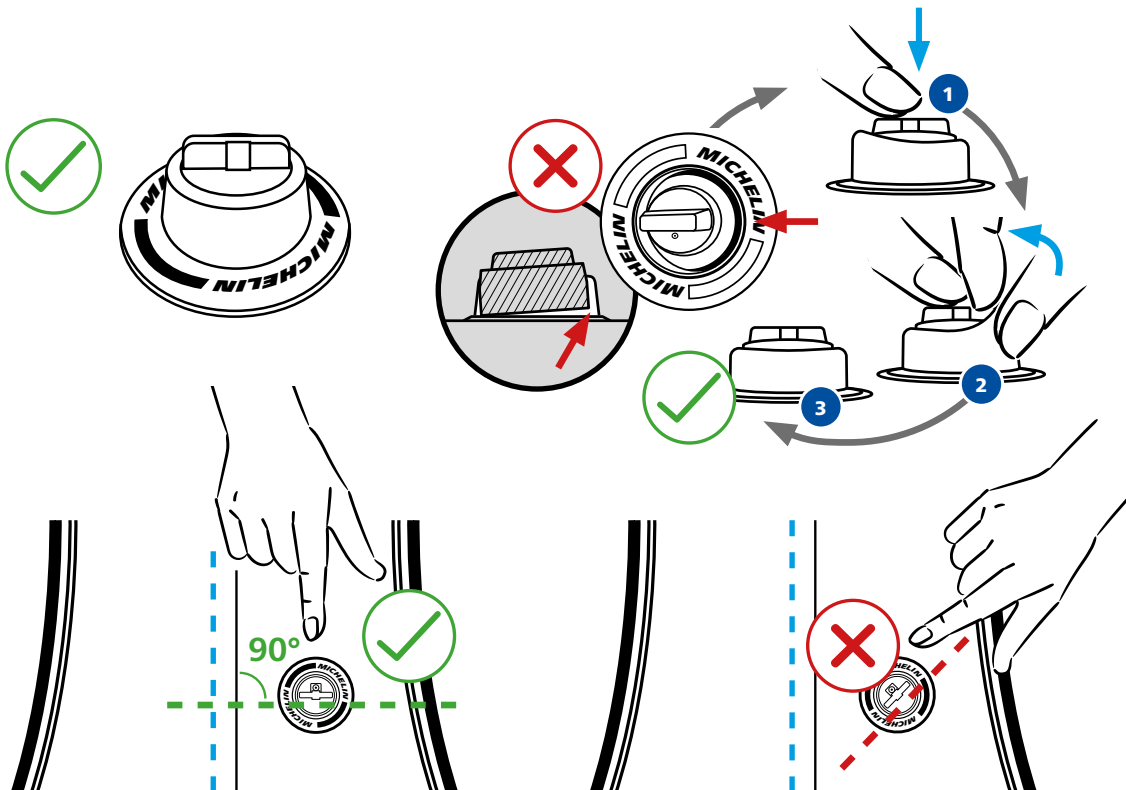

6

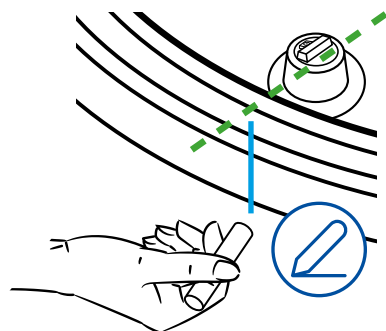

7

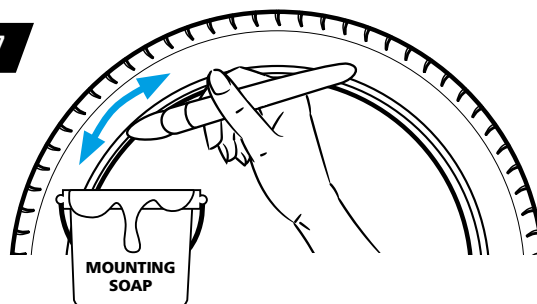

2

RECOMMENDED TYRE FITTING *(WITH A MACHINE)*

1

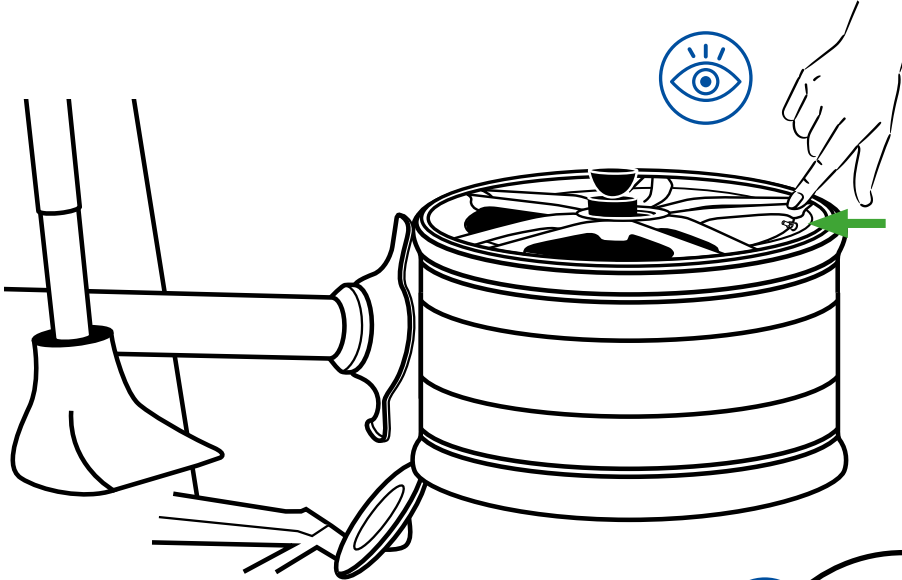

2

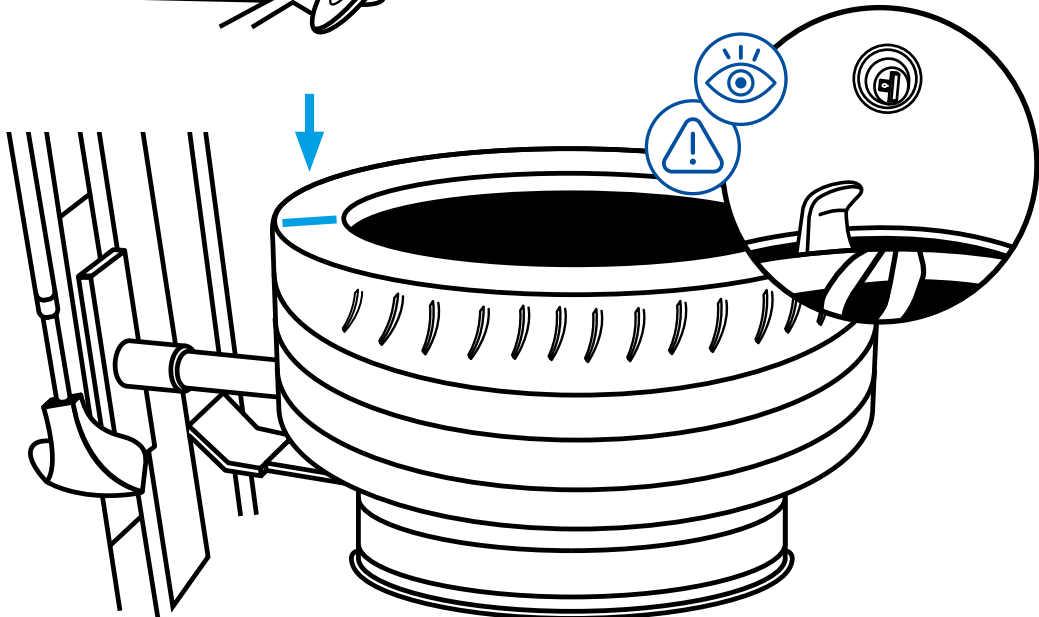

- MONTAGE RECOMMANDÉ DU PNEU (À LA MACHINE)
- EMPFOHLENE MONTAGE DES REIFENS (MIT DER MASCHINE)
- MONTAJE RECOMENDADO DEL NEUMÁTICO (A MÁQUINA)
- MONTAGGIO CONSIGLIATO DEL PNEUMATICO (MONTAGGIO A MACCHINA)
- MONTAGEM RECOMENDADA DO PNEU (NA MÁQUINA)
- AANBEVOLEN MONTAGE VAN BANDEN (MACHINAAL)
- 轮胎组装推荐步骤 (使用工具)

3

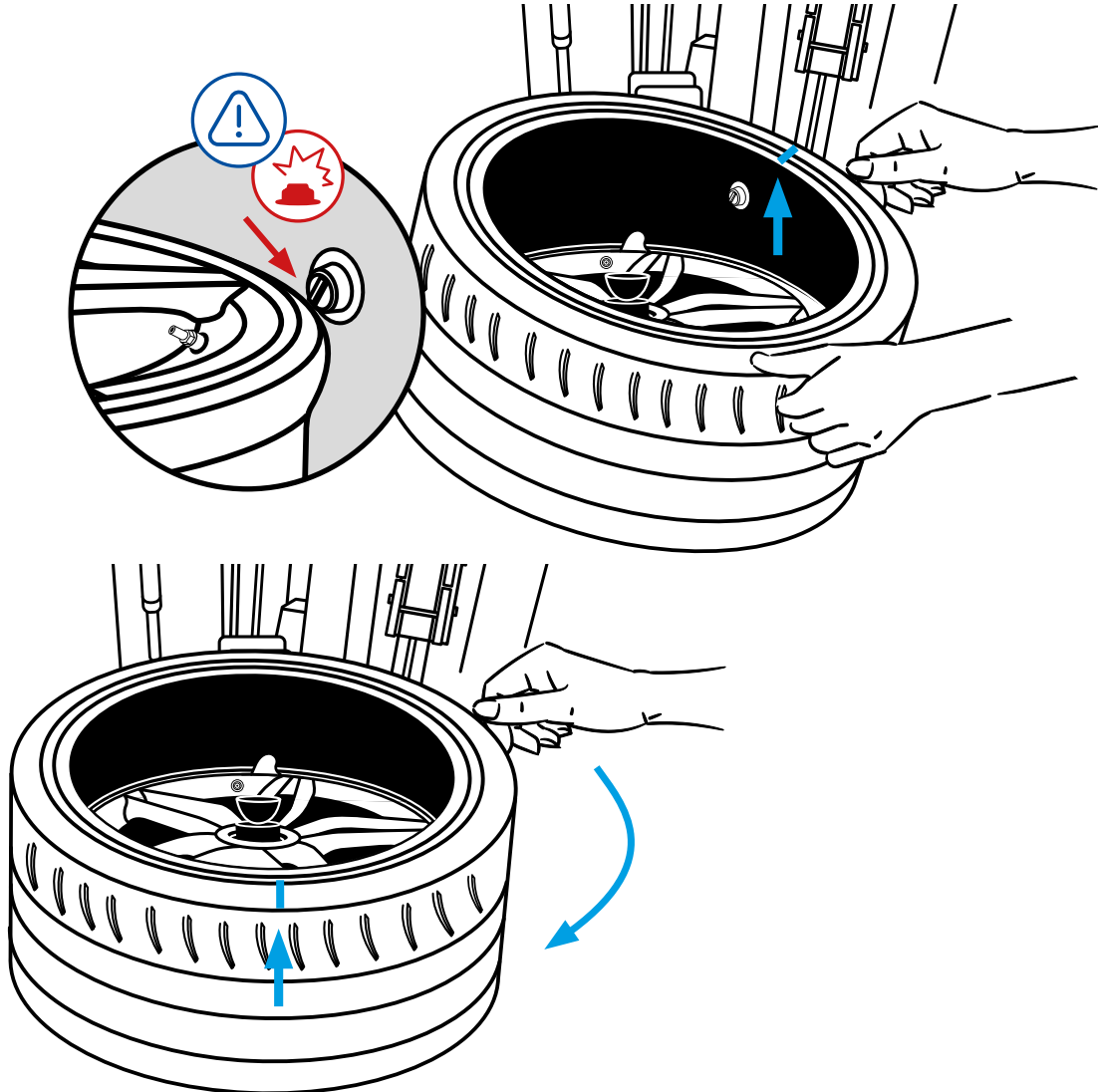

2

RECOMMENDED TYRE FITTING *(WITH A MACHINE)*

4

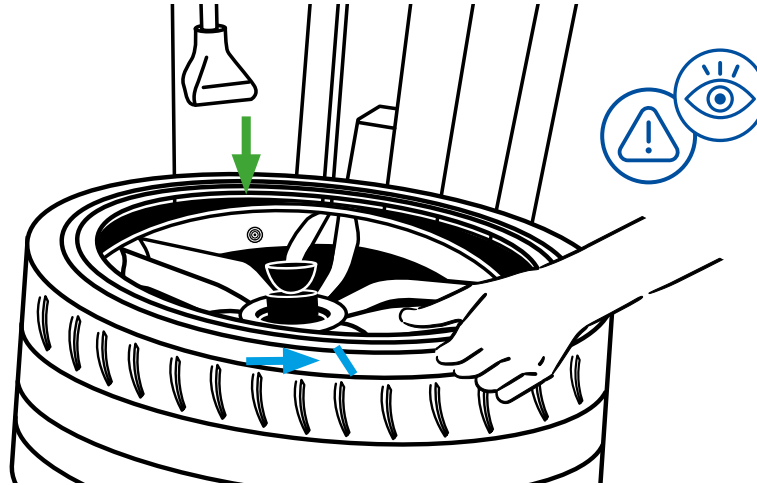

5

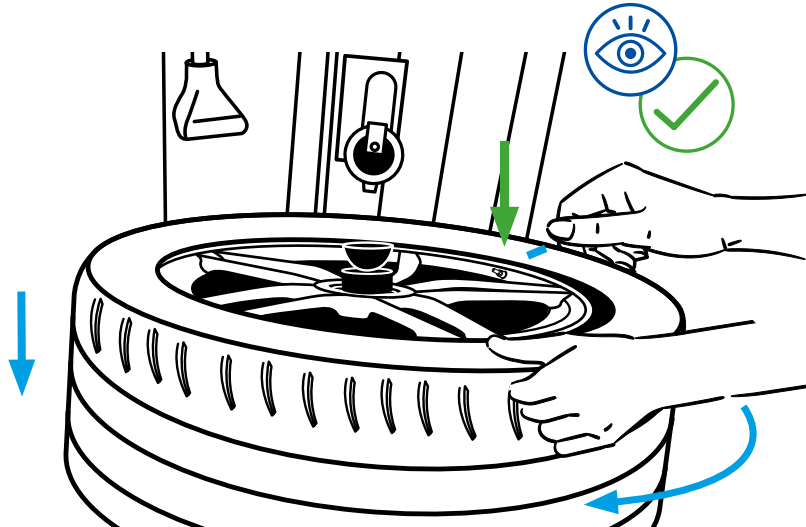

- MONTAGE RECOMMANDÉ DU PNEU (À LA MACHINE)
- EMPFOHLENE MONTAGE DES REIFENS (MIT DER MASCHINE)
- MONTAJE RECOMENDADO DEL NEUMÁTICO (A MÁQUINA)
- MONTAGGIO CONSIGLIATO DEL PNEUMATICO (MONTAGGIO A MACCHINA)
- MONTAGEM RECOMENDADA DO PNEU (NA MÁQUINA)
- AANBEVOLEN MONTAGE VAN BANDEN (MACHINAAL)
- 轮胎组装推荐步骤 (使用工具)

6

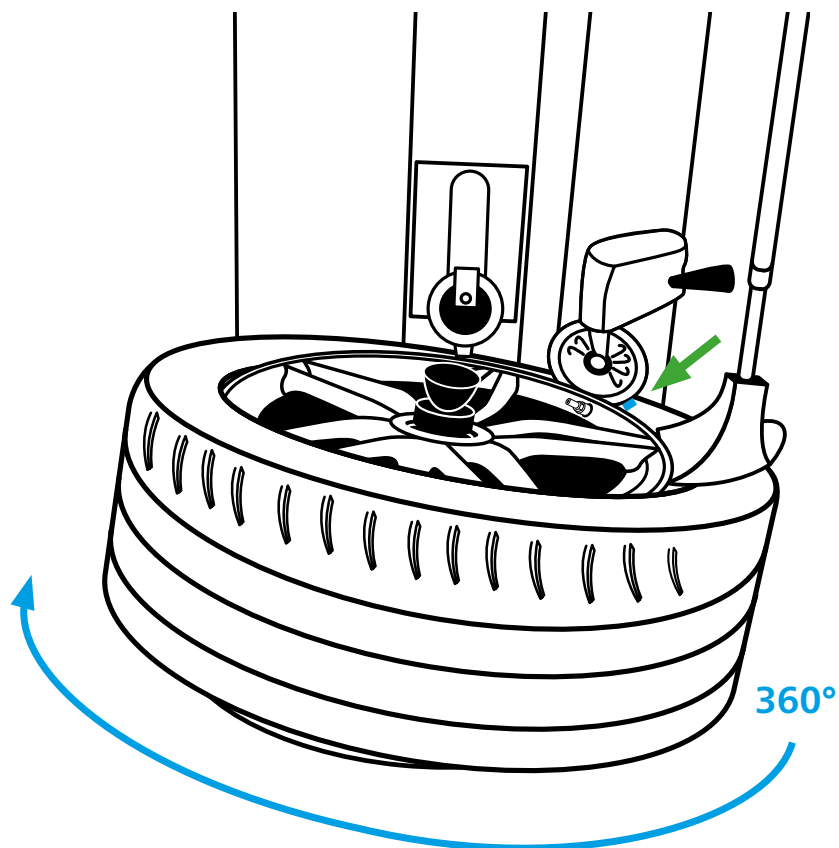

3

INSTALLING THE TYRE ON THE VEHICLE

1

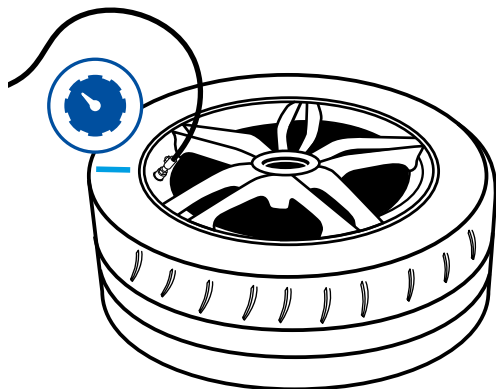

2

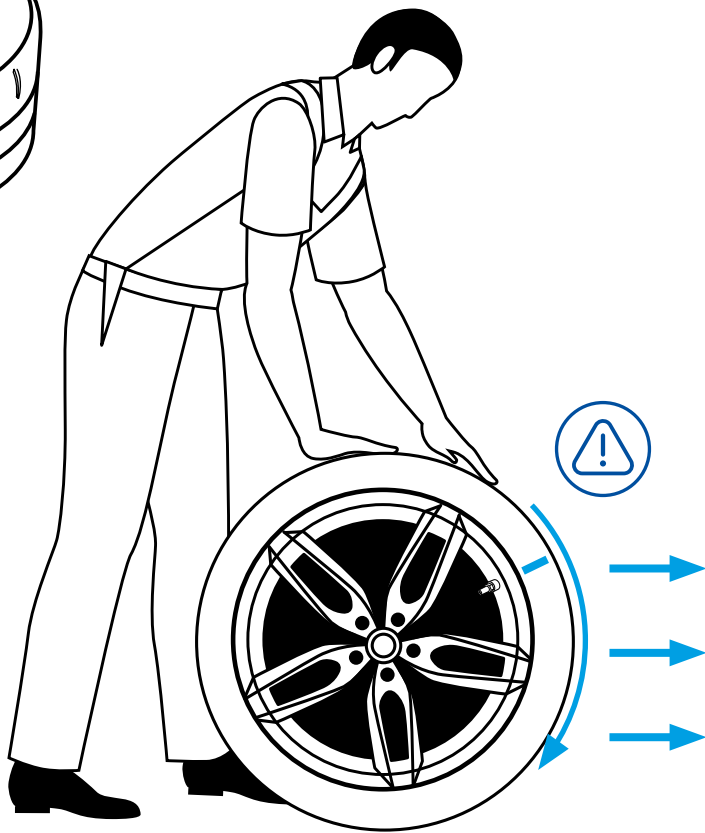

- INSTALLATION DU PNEU SUR LE VÉHICULE
- INSTALLATION DES REIFENS AM FAHRZEUG
- INSTALACIÓN DEL NEUMÁTICO EN EL VEHÍCULO
- INSTALLAZIONE DEL PNEUMATICO SUL VEICOLO
- INSTALAÇÃO DO PNEU NO VEÍCULO
- INSTALLATIE VAN DE BAND OP HET VOERTUIG
- 将轮胎安装回车上

3

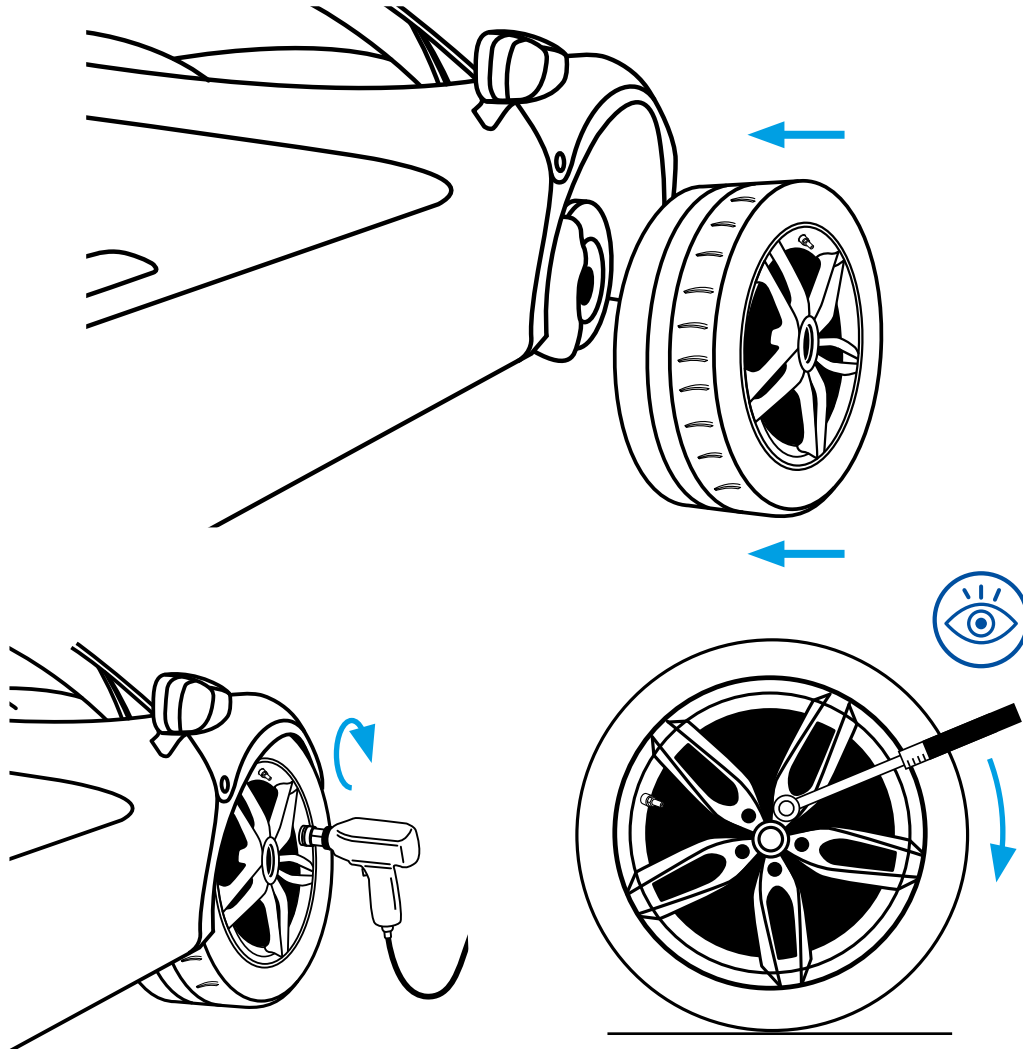

4

INSTALLING AND CONFIGURING THE MICHELIN TRACK CONNECT APP

1



- START THE VEHICLE
- DÉMARRER LE VÉHICULE
- DAS FAHRZEUG STARTEN
- ARRANCAR EL VEHÍCULO
- AVVIARE IL VEICOLO
- DÉ PARTIDA NO VEÍCULO
- HET VOERTUIG STARTEN
- 发动车辆

2



3

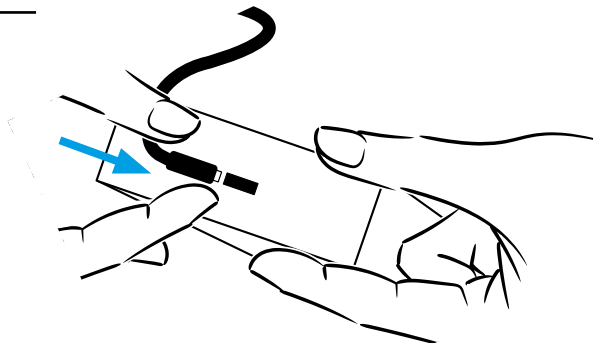

- INSTALLATION ET CONFIGURATION DE L'APPLICATION MICHELIN TRACK CONNECT
- INSTALLATION UND KONFIGURATION DER MICHELIN TRACK CONNECT-APPLIKATION
- INSTALACIÓN Y CONFIGURACIÓN DE LA APLICACIÓN MICHELIN TRACK CONNECT
- INSTALLAZIONE E CONFIGURAZIONE DELL'APPLICAZIONE MICHELIN TRACK CONNECT
- INSTALAÇÃO E CONFIGURAÇÃO DO APLICATIVO MICHELIN TRACK CONNECT
- INSTALLATIE EN CONFIGURATIE VAN DE MICHELIN TRACK CONNECT TOEPASSING
- 安装并设置米其林TRACK CONNECT应用程序

4

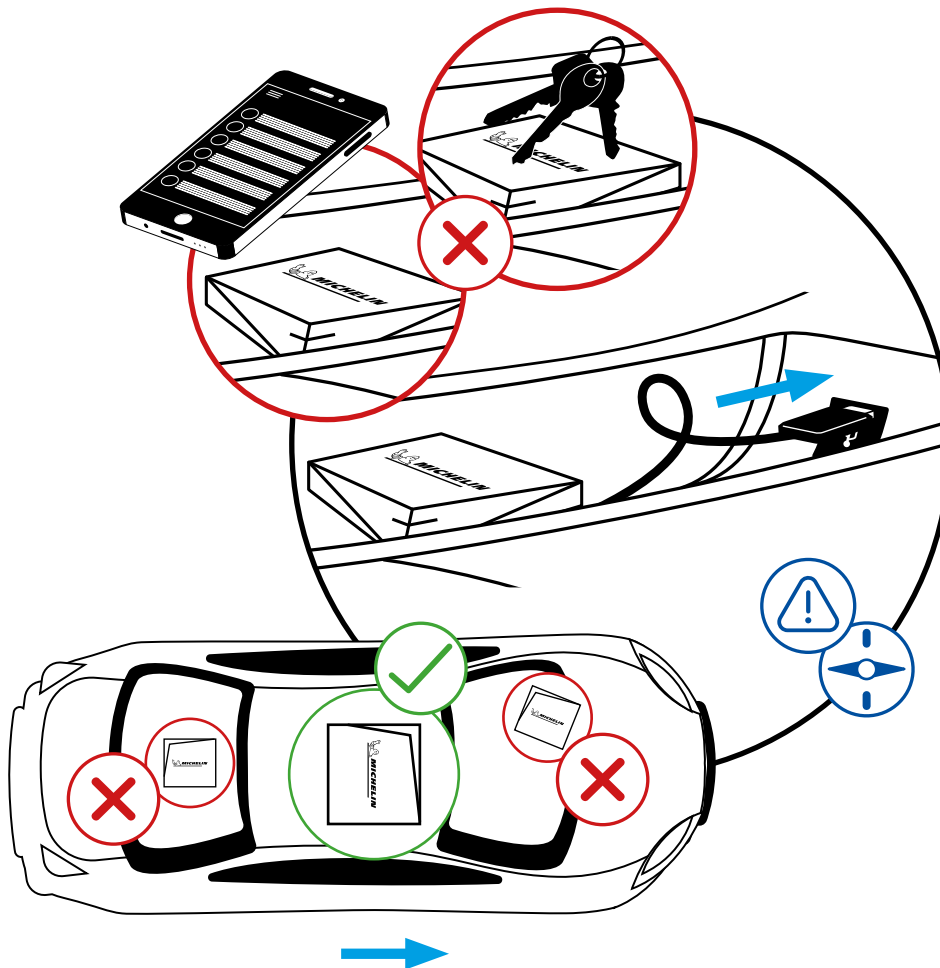

4

INSTALLING AND CONFIGURING THE MICHELIN TRACK CONNECT APP

5



MICHELIN TRACK CONNECT

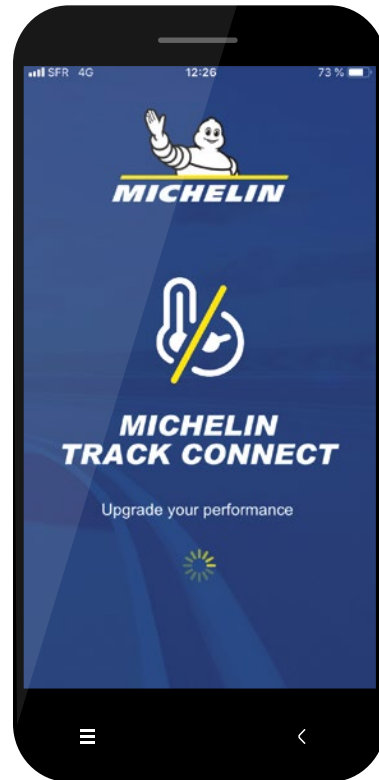

- INSTALLATION ET CONFIGURATION DE L'APPLICATION MICHELIN TRACK CONNECT
- INSTALLATION UND KONFIGURATION DER MICHELIN TRACK CONNECT-APPLIKATION
- INSTALACIÓN Y CONFIGURACIÓN DE LA APLICACIÓN MICHELIN TRACK CONNECT
- INSTALLAZIONE E CONFIGURAZIONE DELL'APPLICAZIONE MICHELIN TRACK CONNECT
- INSTALAÇÃO E CONFIGURAÇÃO DO APLICATIVO MICHELIN TRACK CONNECT
- INSTALLATIE EN CONFIGURATIE VAN DE MICHELIN TRACK CONNECT TOEPASSING
- 安装并设置米其林TRACK CONNECT应用程序

6

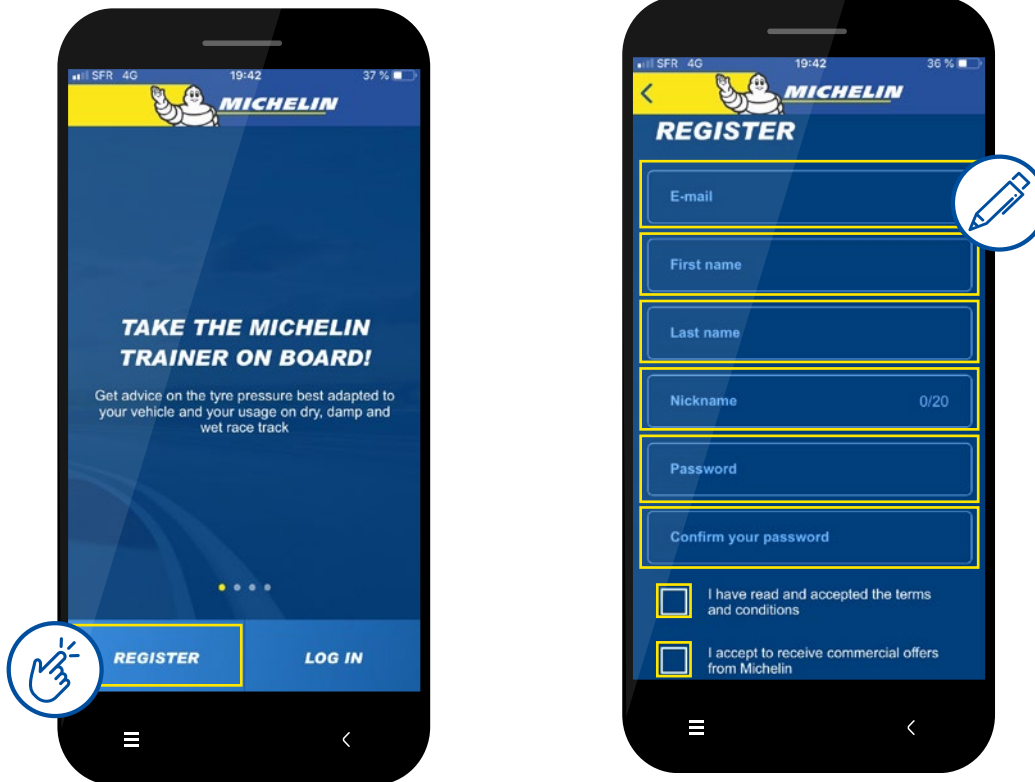

4

INSTALLING AND CONFIGURING THE MICHELIN TRACK CONNECT APP

7

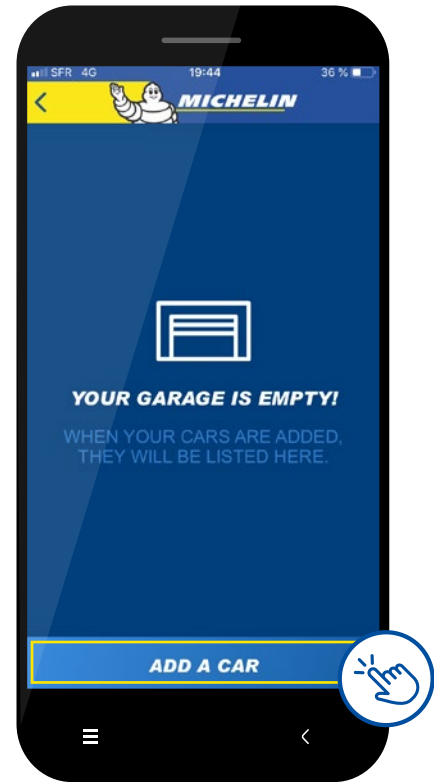
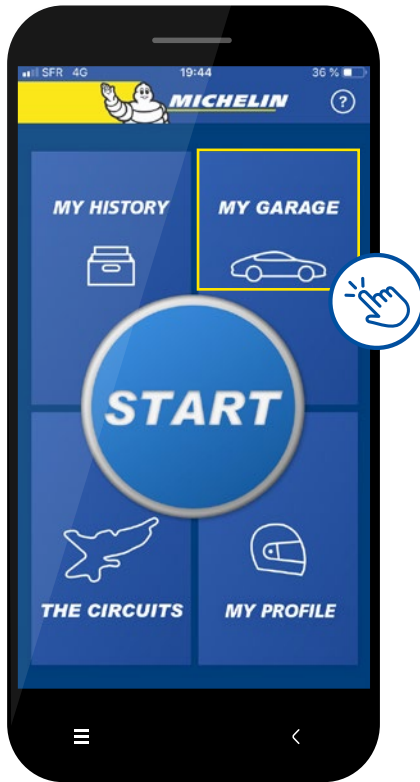

- INSTALLATION ET CONFIGURATION DE L'APPLICATION MICHELIN TRACK CONNECT
- INSTALLATION UND KONFIGURATION DER MICHELIN TRACK CONNECT-APPLIKATION
- INSTALACIÓN Y CONFIGURACIÓN DE LA APLICACIÓN MICHELIN TRACK CONNECT
- INSTALLAZIONE E CONFIGURAZIONE DELL'APPLICAZIONE MICHELIN TRACK CONNECT
- INSTALAÇÃO E CONFIGURAÇÃO DO APLICATIVO MICHELIN TRACK CONNECT
- INSTALLATIE EN CONFIGURATIE VAN DE MICHELIN TRACK CONNECT TOEPASSING
- 安装并设置米其林TRACK CONNECT应用程序

8

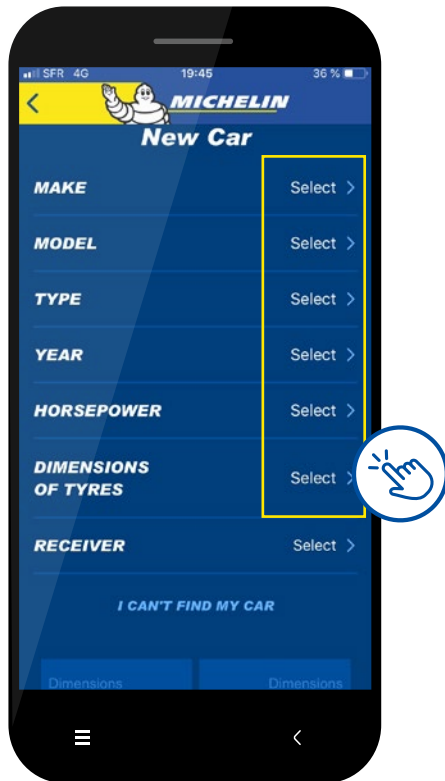

9



5

INSTALLING AND PAIRING THE RECEIVER IN THE VEHICLE IN THE VEHICLE

1

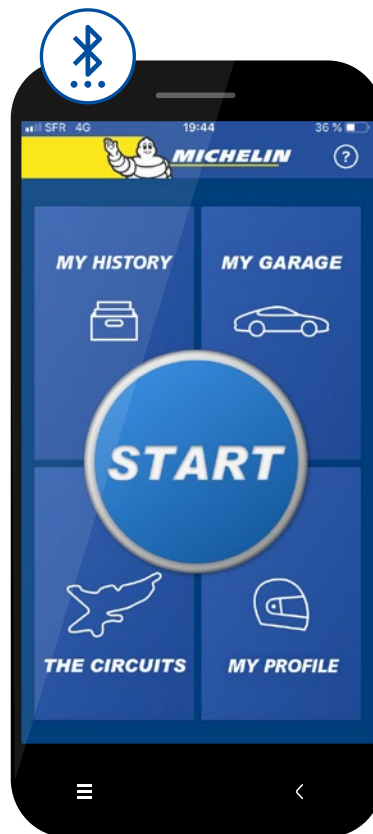
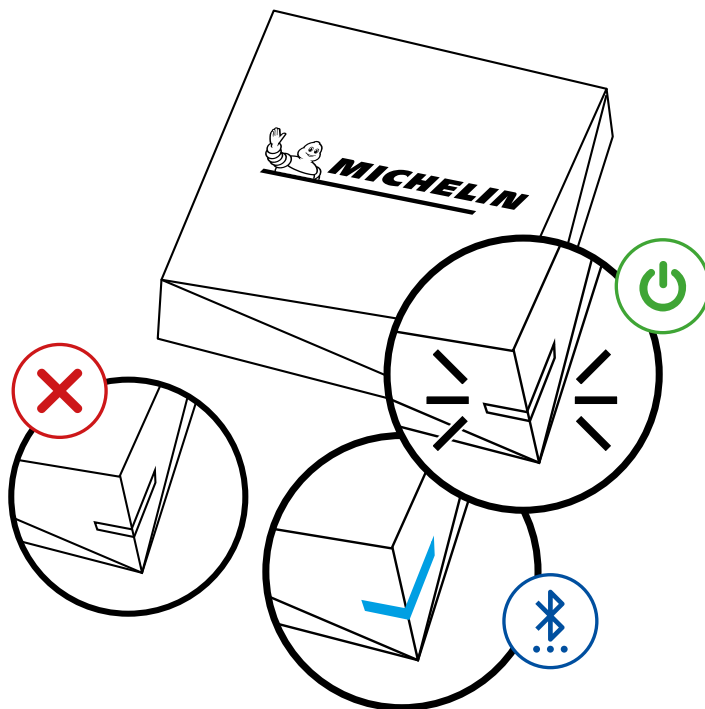

- STORE THE RECEIVER IN THE CASE WHEN NOT IN USE
- RANGER LE RÉCEPTEUR DANS SA HOUSSE APRÈS UTILISATION
- DEN EMPFÄNGER NACH DEM GEBRAUCH IN SEINER HÜLLE VERSTAUEN
- GUARDAR EL RECEPTOR EN SU BOLSA DESPUÉS DE CADA USO
- CONSERVARE IL RICEVITORE NELLA SUA CUSTODIA DOPO L'USO
- GARDE O RECEPTOR NA CAPA APÓS A UTILIZAÇÃO
- DE ONTVANGER NA GEBRUIK IN ZIJN HOES OPBERGEN
- 使用完毕后请将接收器放回保护套中

- INSTALLATION ET APPAIRAGE DU RÉCEPTEUR DANS LE VÉHICULE
- INSTALLATION UND PAIRING DES EMPFÄNGERS IM FAHRZEUG
- INSTALACIÓN Y CONEXIÓN DEL RECEPTOR EN EL VEHÍCULO
- INSTALLAZIONE E ACCOPPIAMENTO DEL RICEVITORE NEL VEICOLO
- INSTALAÇÃO E PAREAMENTO DO RECEPTOR NO VEÍCULO
- INSTALLATIE EN KOPPELING VAN DE ONTVANGER IN HET VOERTUIG
- 在车中安装并匹配接收器

2

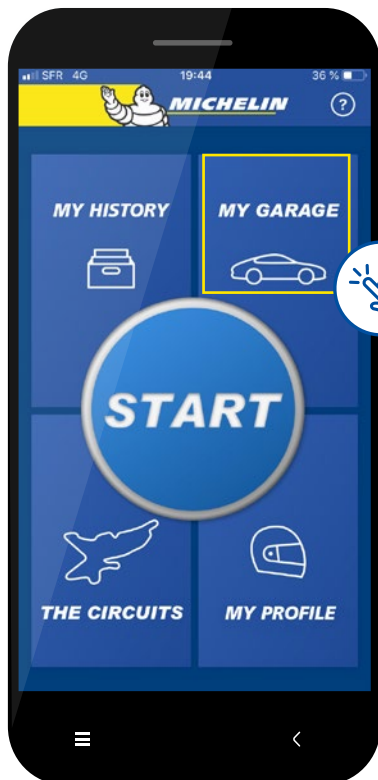

The receiver and phone must be paired using the MTC* app. Do not pair in the phone's Bluetooth settings.

- L'appairage du récepteur avec le téléphone doit se faire impérativement avec l'application MTC*. Il ne faut pas faire l'appairage dans les réglages bluetooth du téléphone.
- Das Pairing des Empfängers mit dem Telefon muss unbedingt mit der MTC*-App erfolgen. Das Pairing darf nicht in den Bluetooth-Einstellungen des Telefons vorgenommen werden.
- La sincronización del receptor con el teléfono debe hacerse obligatoriamente con la aplicación MTC*. No hay que hacer la sincronización a través de los ajustes bluetooth del teléfono.
- L'accoppiamento del ricevitore con il telefono deve essere fatto tassativamente con l'applicazione MTC*. L'accoppiamento non deve essere eseguito nelle impostazioni Bluetooth del telefono.
- O emparelhamento do receptor com o telefone deve ser realizado, obrigatoriamente, com a aplicação MTC*. Não é necessário realizar o emparelhamento nas definições Bluetooth do telefone.
- Het koppelen van de ontvanger met de telefoon moet worden gedaan met de MTC*-applicatie. De koppeling mag niet worden uitgevoerd in de Bluetooth-instellingen van de telefoon.
- 接收器必须通过MTC*应用程序与手机配对。请不要在手机蓝牙设置中进行配对。



*MTC : MICHELIN TRACK CONNECT

5

INSTALLING AND PAIRING THE RECEIVER IN THE VEHICLE

3

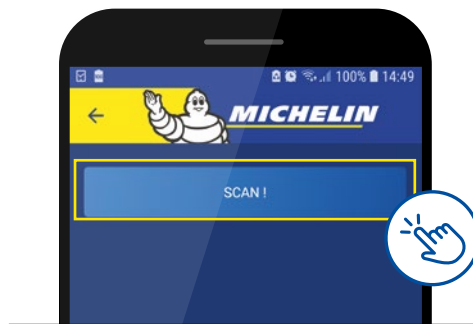
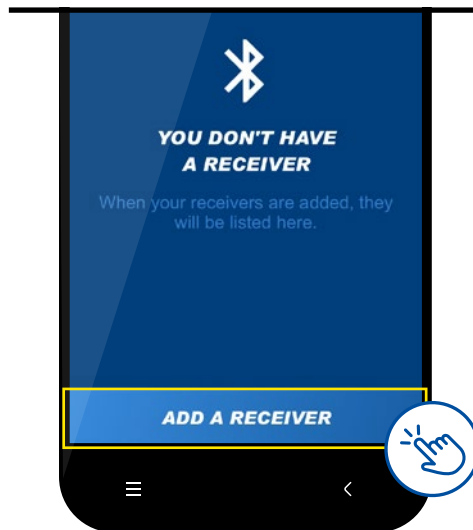

- INSTALLATION ET APPAIRAGE DU RÉCEPTEUR DANS LE VÉHICULE
- INSTALLATION UND PAIRING DES EMPFÄNGERS IM FAHRZEUG
- INSTALACIÓN Y CONEXIÓN DEL RECEPTOR EN EL VEHÍCULO
- INSTALLAZIONE E ACCOPPIAMENTO DEL RICEVITORE NEL VEICOLO
- INSTALAÇÃO E PAREAMENTO DO RECEPTOR NO VEÍCULO
- INSTALLATIE EN KOPPELING VAN DE ONTVANGER IN HET VOERTUIG
- 在车中安装并匹配接收器

4

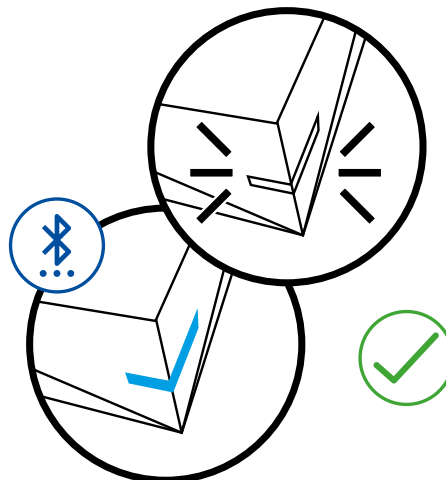
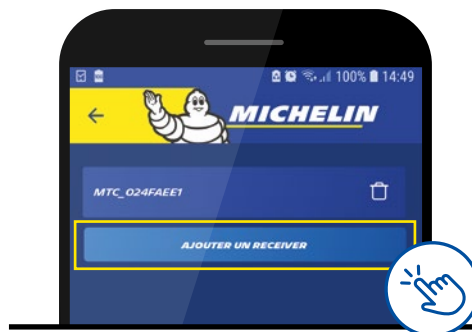

6

PAIRING THE SENSORS WITH THE MICHELIN TRACK CONNECT APP

1

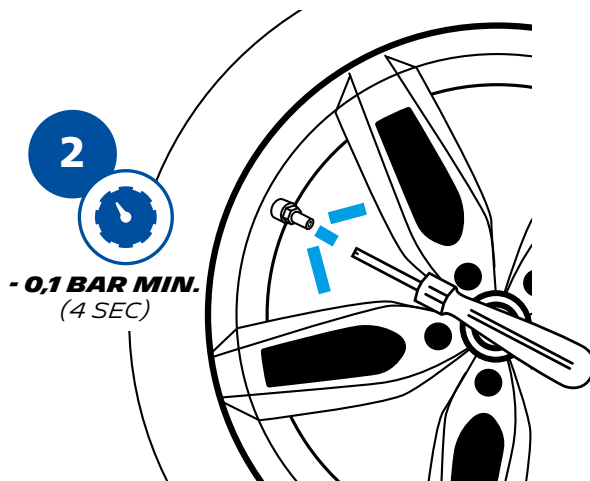

3

WAIT FOR
1 MIN MAX.

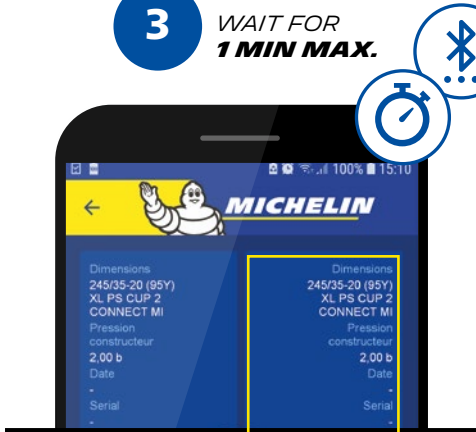

4



- APPAIRAGE DES CAPTEURS AVEC L'APPLICATION MICHELIN TRACK CONNECT
- PAIRING DER SENSOREN MIT DER MICHELIN TRACK CONNECT-APPLIKATION
- VINCULACIÓN DE LOS SENSORES CON LA APLICACIÓN MICHELIN TRACK CONNECT
- ACCOPPIAMENTO DEI SENSORI CON L'APPLICAZIONE MICHELIN TRACK CONNECT
- PAREAMENTO DOS SENSORES COM O APLICATIVO MICHELIN TRACK CONNECT
- KOPPELING VAN SENSOREN MET DE MICHELIN TRACK CONNECT TOEPASSING
- 将传感器与米其林TRACK CONNECT应用程序配对

2

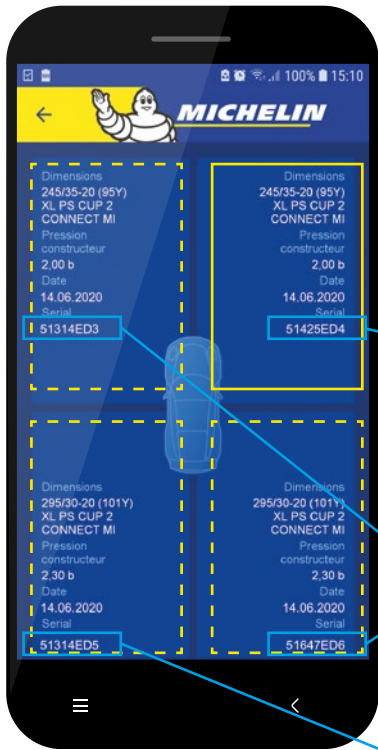

Check and refer to page 5

- Contrôler et se référer à la page 5
- Kennungen prüfen (siehe Seite 5)
- Controlar y referirse a la página 5
- Controllare e riportarsi alla pagina 5.
- Controlar e referir-se à página 5
- Controleer en raadpleeg pagina 5.
- 检查并参考第5页

⊖ ID: 2

⊕ ID: 5

Example: 51425ED4

⊖ ID: 2

⊕ ID: 5

Example: 51425ED6

⊖ ID: 2

⊕ ID: 5

Example: 51425ED3

⊖ ID: 2

⊕ ID: 5

Example: 51425ED5

REPEAT
4X



6

PAIRING THE SENSORS WITH THE MICHELIN TRACK CONNECT APP

3

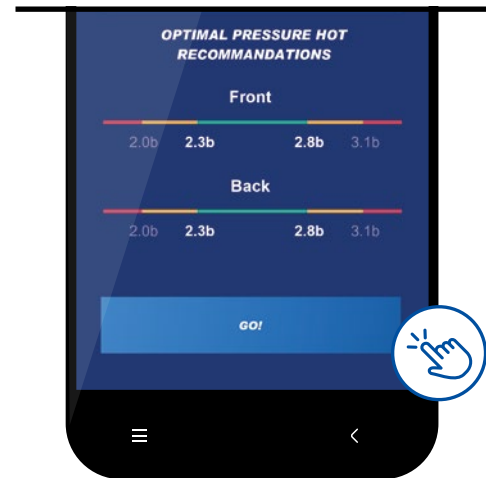
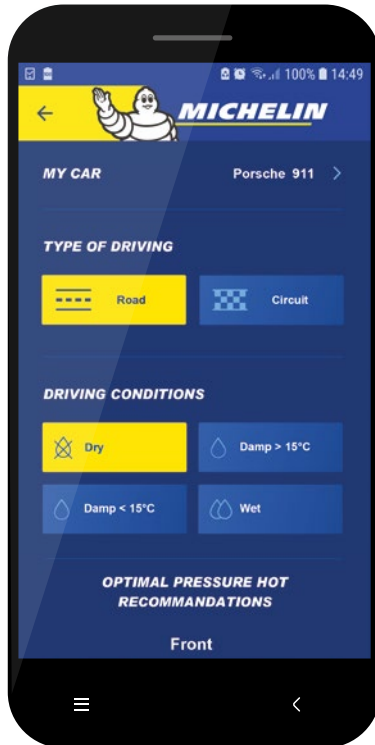

- APPAIRAGE DES CAPTEURS AVEC L'APPLICATION MICHELIN TRACK CONNECT
- PAIRING DER SENSOREN MIT DER MICHELIN TRACK CONNECT-APPLIKATION
- VINCULACIÓN DE LOS SENSORES CON LA APLICACIÓN MICHELIN TRACK CONNECT
- ACCOPPIAMENTO DEI SENSORI CON L'APPLICAZIONE MICHELIN TRACK CONNECT
- PAREAMENTO DOS SENSORES COM O APLICATIVO MICHELIN TRACK CONNECT
- KOPPELING VAN SENSOREN MET DE MICHELIN TRACK CONNECT TOEPASSING
- 将传感器与米其林TRACK CONNECT应用程序配对

4

Check that the 4 sensors, the pressure and temperature of the 4 tires are displayed once you have driven for a few minutes at > 30km/h.

Vérifier que les 4 capteurs, la pression et la température des 4 pneus s'affichent après avoir roulé quelques minutes à une vitesse > 30km/h.

Prüfen, ob die 4 Sensoren, der Reifendruck und die Temperatur der 4 Reifen angezeigt werden, nachdem Sie einige Minuten lang bei einer Geschwindigkeit von > 30 km/h gefahren sind.

Verificar que los 4 sensores, la presión y la temperatura de los 4 neumáticos se visualizan después de haber conducido algunos minutos a una velocidad > 30km/h.

Controllare che i 4 sensori, la pressione e la temperatura dei 4 pneumatici vengano visualizzati dopo aver guidato per alcuni minuti ad una velocità > 30km/h.

Verificar se os 4 sensores, a pressão e a temperatura dos 4 pneus se exhibe depois de ter rodado alguns minutos a velocidade > 30 km/h.

Controleer of de vier sensoren, de druk en de temperatuur van de 4 banden worden weergegeven na een paar minuten rijden met een snelheid > 30 km/u.

以速度大于30公里/小时行使几分钟后，检查4个传感器是否显示4个轮胎的压力和温度。

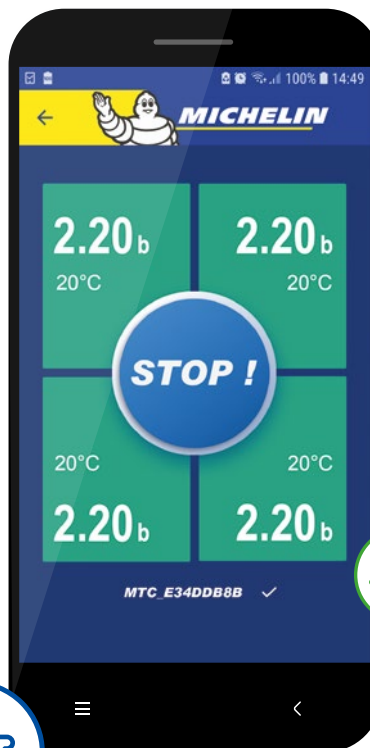

REMOVING THE SENSOR FROM THE TIRE

- DÉMONTAGE DU CAPTEUR DU PNEUMATIQUE
- DEMONTAGE DES REIFENSORS
- DESMONTAJE DEL SENSOR DEL NEUMÁTICO
- SMONTAGGIO DEL SENSORE DAL PNEUMATICO
- DESMONTAGEM DO SENSOR DO PNEU
- VERWIJDERING VAN DE SENSOR VAN DE BAND
- 卸下轮胎传感器。

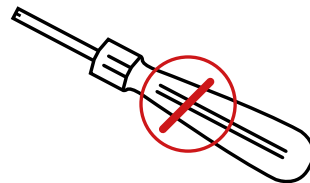

1

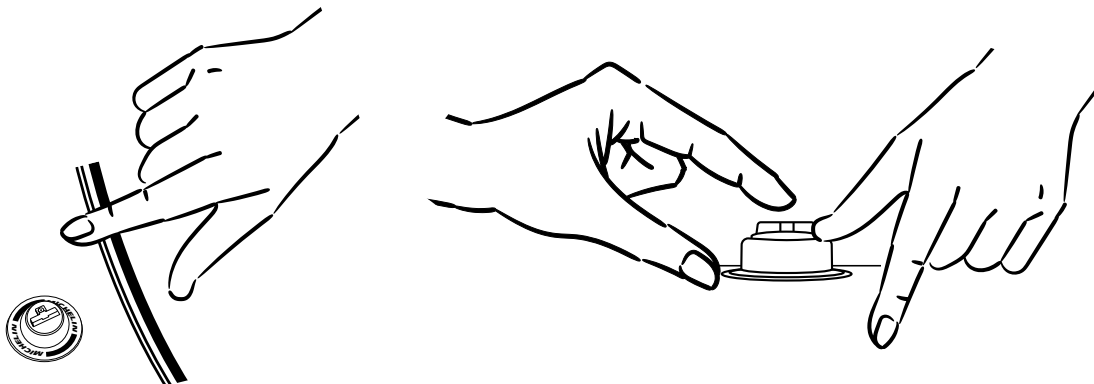

2

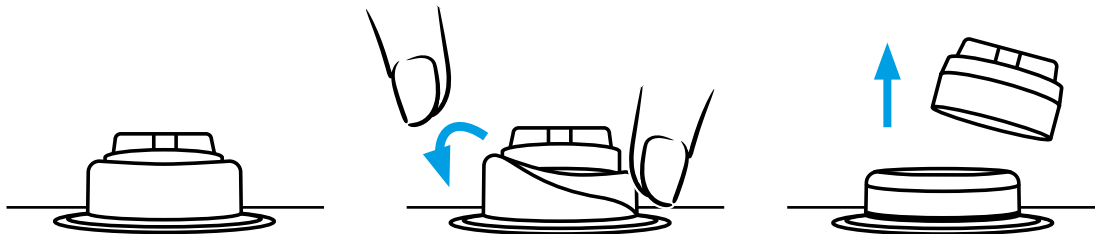

CONTACT US

Got a question? Get in touch using the «Contact us» section of the MICHELIN TRACK CONNECT app or visit the Michelin website for your country. You can access it via the app's «Frequently Asked Questions» section.

NOUS CONTACTER

Une question ? Retrouvez nous dans la rubrique «Nous contacter» de l'application MICHELIN TRACK CONNECT ou veuillez-vous référer au site internet Michelin de votre pays. Vous pouvez y accéder via l'application dans la rubrique «Questions Fréquentes».

KONTAKTAUFNAHME

Eine Frage? Sie finden uns unter der Rubrik «Uns kontaktieren» der MICHELIN TRACK CONNECT-App oder auf der Michelin-Website Ihres Landes. Zugriff über die App unter der Rubrik «Häufige Fragen».

CONTACTARNOS

¿Una pregunta? Encuéntrenos en la pestaña «Contactarnos» de la aplicación MICHELIN TRACK CONNECT o remitiéndose al sitio web Michelin de su país. Puede acceder por medio de la aplicación en la pestaña «Preguntas Frecuentes».

CONTATTARCI

Una domanda? Andare alla sezione «Contattarci» dell'applicazione MICHELIN TRACK CONNECT oppure riportarsi al sito internet Michelin del proprio paese. È possibile accedervi tramite l'applicazione nella sezione «Domande frequenti».

CONTACTE-NOS

Tem alguma pergunta? Pode encontrar-nos na secção «Contacte-nos» da aplicação MICHELIN TRACK CONNECT ou pode consultar o site da Michelin do seu país. Pode aceder através da aplicação na secção «Perguntas Freqüentes».

CONTACT

Wanneer u vragen heeft, kunt u contact met ons opnemen via de rubriek «Contact» van de applicatie MICHELIN TRACK CONNECT of de website van Michelin in uw land raadplegen. U kunt deze vinden via de applicatie in de rubriek «Vaak gestelde vragen».

联系我们

遇到问题？您可以通过MICHELIN TRACK CONNECT应用程序中的“联系我们”版块与我们联系，或参考您所在国家的Michelin网站。您可以通过应用程序中的“常见问题”版块进行访问。

